

CMOS System Reset IC Built-in Delay time circuit Monolithic IC KIC77A/B/C/D/E**T/T2/M/M2 Series

This IC is a system reset IC built in delay time circuit.
KIC77 series is not required with an external capacitor, and then can use a small package. Therefore, a space of PC board can be small.

Features

- Operating supply voltage : 1.0 ~ 7.0V
- Supply current 0.5μ A (Typ.)
- Reset threshold range : 1.6 ~ 5.0V
- Reset threshold accuracy : ± 1%
- Other Threshold voltage : 2.63V, 2.93V, 3.08V, 4.38V, 4.63V
- Reset active timeout period : 240/50/100/200/400ms
- Output type : Open drain output

Applications

- Reset circuits for microcomputers, CPUs and MPUs
- Reset circuits for logic circuits
- Battery voltage check circuits
- Back-up power supply switching circuits
- Level detection circuits

Pin Configuration

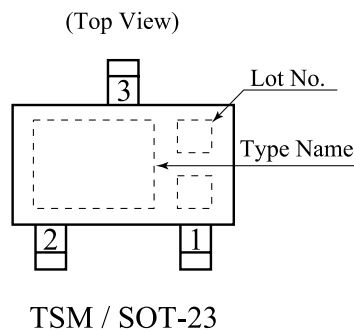

Pin No	Pin Configuration	
	KIC77A/B/C/D/E**T/M	KIC77A/B/C/D/E**T2/M2
1	GND	V _{OUT}
2	V _{OUT}	GND
3	V _{DD}	V _{DD}

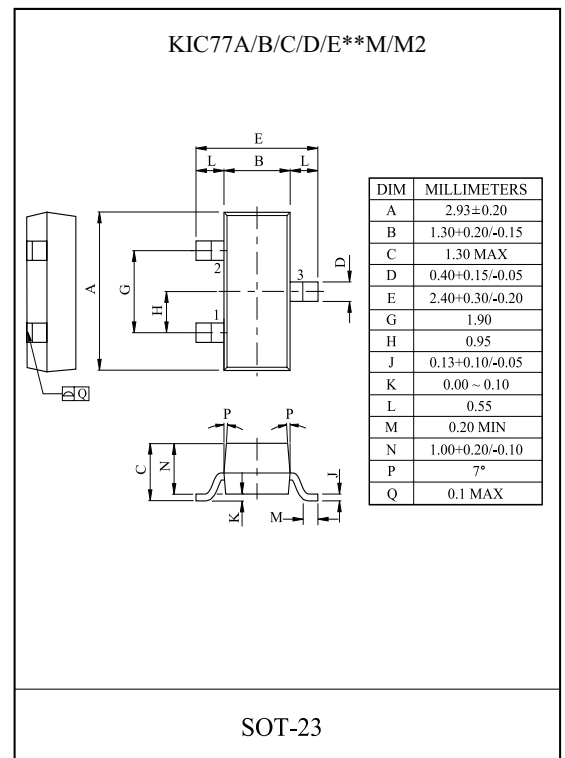
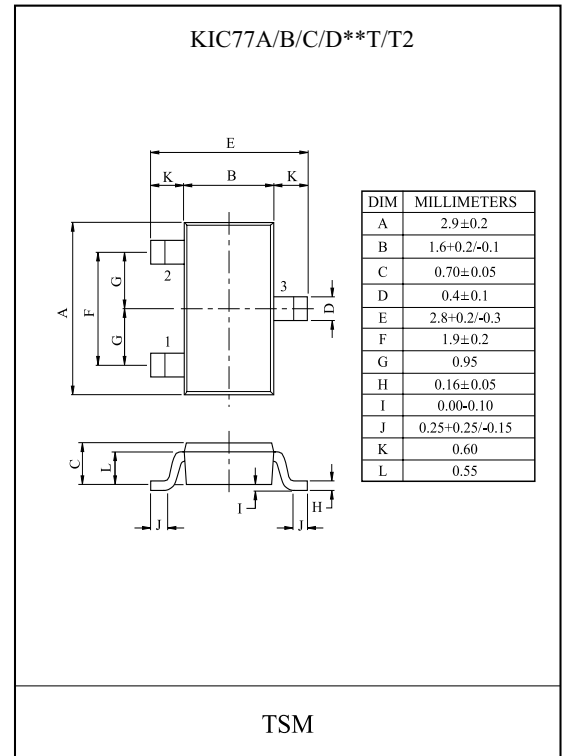

KIC77A/B/C/D/E16~50T/T2/M/M2

Block Diagram

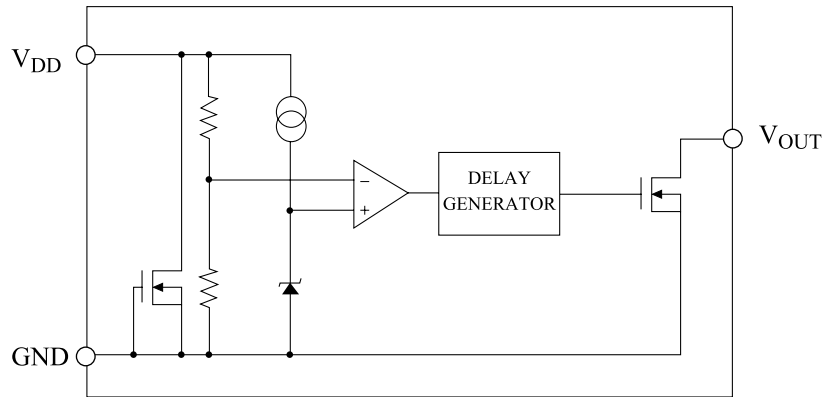

Figure. 1

Selection Guide

The output voltage, package type for the ICs can be selected at the user's request.

The selection can be made with designating the part number as shown below

KIC7 7 □ □□ □□
 ① ② ③ ④

NO.	Specifications	Description
①	Function	Internal Reset
②	Delay Time	A : 240ms B : 50ms C : 100ms D : 200ms E : 400ms
③	Reset Voltage	1.6 ~5.0V
④	Package	T/M 1. GND 2. V _{OUT} 3. V _{DD}
		T2/M2 1. V _{OUT} 2. GND 3. V _{DD}

KIC77A/B/C/D/E16~50T/T2/M/M2

Line-up-1 (KIC77A/B/C/D/E16~50T)

Detecting Voltage	KIC77A16~50T		KIC77B16~50T		KIC77C16~50T		KIC77D16~50T		KIC77E16~50T	
	Item	Marking	Item	Marking	Item	Marking	Item	Marking	Item	Marking
1.6V	KIC77A16T	A16	KIC77B16T	B16	KIC77C16T	C16	KIC77D16T	D16	KIC77E16T	E16
1.7V	KIC77A17T	A17	KIC77B17T	B17	KIC77C17T	C17	KIC77D17T	D17	KIC77E17T	E17
1.8V	KIC77A18T	A18	KIC77B18T	B18	KIC77C18T	C18	KIC77D18T	D18	KIC77E18T	E18
1.9V	KIC77A19T	A19	KIC77B19T	B19	KIC77C19T	C19	KIC77D19T	D19	KIC77E19T	E19
2.0V	KIC77A20T	A20	KIC77B20T	B20	KIC77C20T	C20	KIC77D20T	D20	KIC77E20T	E20
2.1V	KIC77A21T	A21	KIC77B21T	B21	KIC77C21T	C21	KIC77D21T	D21	KIC77E21T	E21
2.2V	KIC77A22T	A22	KIC77B22T	B22	KIC77C22T	C22	KIC77D22T	D22	KIC77E22T	E22
2.3V	KIC77A23T	A23	KIC77B23T	B23	KIC77C23T	C23	KIC77D23T	D23	KIC77E23T	E23
2.4V	KIC77A24T	A24	KIC77B24T	B24	KIC77C24T	C24	KIC77D24T	D24	KIC77E24T	E24
2.5V	KIC77A25T	A25	KIC77B25T	B25	KIC77C25T	C25	KIC77D25T	D25	KIC77E25T	E25
2.6V	KIC77A26T	A26	KIC77B26T	B26	KIC77C26T	C26	KIC77D26T	D26	KIC77E26T	E26
2.63V	KIC77A263T	A2F	KIC77B263T	B2F	KIC77C263T	C2F	KIC77D263T	D2F	KIC77E263T	E2F
2.7V	KIC77A27T	A27	KIC77B27T	B27	KIC77C27T	C27	KIC77D27T	D27	KIC77E27T	E27
2.8V	KIC77A28T	A28	KIC77B28T	B28	KIC77C28T	C28	KIC77D28T	D28	KIC77E28T	E28
2.9V	KIC77A29T	A29	KIC77B29T	B29	KIC77C29T	C29	KIC77D29T	D29	KIC77E29T	E29
2.93V	KIC77A293T	A2I	KIC77B293T	B2I	KIC77C293T	C2I	KIC77D293T	D2I	KIC77E293T	E2I
3.0V	KIC77A30T	A30	KIC77B30T	B30	KIC77C30T	C30	KIC77D30T	D30	KIC77E30T	E30
3.08V	KIC77A308T	A3Z	KIC77B308T	B3Z	KIC77C308T	C3Z	KIC77D308T	D3Z	KIC77E308T	E3Z
3.1V	KIC77A31T	A31	KIC77B31T	B31	KIC77C31T	C31	KIC77D31T	D31	KIC77E31T	E31
3.2V	KIC77A32T	A32	KIC77B32T	B32	KIC77C32T	C32	KIC77D32T	D32	KIC77E32T	E32
3.3V	KIC77A33T	A33	KIC77B33T	B33	KIC77C33T	C33	KIC77D33T	D33	KIC77E33T	E33
3.4V	KIC77A34T	A34	KIC77B34T	B34	KIC77C34T	C34	KIC77D34T	D34	KIC77E34T	E34
3.5V	KIC77A35T	A35	KIC77B35T	B35	KIC77C35T	C35	KIC77D35T	D35	KIC77E35T	E35
3.6V	KIC77A36T	A36	KIC77B36T	B36	KIC77C36T	C36	KIC77D36T	D36	KIC77E36T	E36
3.7V	KIC77A37T	A37	KIC77B37T	B37	KIC77C37T	C37	KIC77D37T	D37	KIC77E37T	E37
3.8V	KIC77A38T	A38	KIC77B38T	B38	KIC77C38T	C38	KIC77D38T	D38	KIC77E38T	E38
3.9V	KIC77A39T	A39	KIC77B39T	B39	KIC77C39T	C39	KIC77D39T	D39	KIC77E39T	E39
4.0V	KIC77A40T	A40	KIC77B40T	B40	KIC77C40T	C40	KIC77D40T	D40	KIC77E40T	E40
4.1V	KIC77A41T	A41	KIC77B41T	B41	KIC77C41T	C41	KIC77D41T	D41	KIC77E41T	E41
4.2V	KIC77A42T	A42	KIC77B42T	B42	KIC77C42T	C42	KIC77D42T	D42	KIC77E42T	E42
4.3V	KIC77A43T	A43	KIC77B43T	B43	KIC77C43T	C43	KIC77D43T	D43	KIC77E43T	E43
4.38V	KIC77A438T	A4C	KIC77B438T	B4C	KIC77C438T	C4C	KIC77D438T	D4C	KIC77E438T	E4C
4.4V	KIC77A44T	A44	KIC77B44T	B44	KIC77C44T	C44	KIC77D44T	D44	KIC77E44T	E44
4.5V	KIC77A45T	A45	KIC77B45T	B45	KIC77C45T	C45	KIC77D45T	D45	KIC77E45T	E45
4.6V	KIC77A46T	A46	KIC77B46T	B46	KIC77C46T	C46	KIC77D46T	D46	KIC77E46T	E46
4.63V	KIC77A463T	A4F	KIC77B463T	B4F	KIC77C463T	C4F	KIC77D463T	D4F	KIC77E463T	E4F
4.7V	KIC77A47T	A47	KIC77B47T	B47	KIC77C47T	C47	KIC77D47T	D47	KIC77E47T	E47
4.8V	KIC77A48T	A48	KIC77BA48T	B48	KIC77C48T	C48	KIC77D48T	D48	KIC77E48T	E48
4.9V	KIC77A49T	A49	KIC77B49T	B49	KIC77C49T	C49	KIC77D49T	D49	KIC77E49T	E49
5.0V	KIC77A50T	A50	KIC77BA50T	B50	KIC77C50T	C50	KIC77D50T	D50	KIC77E50T	E50

KIC77A/B/C/D/E16~50T/T2/M/M2

Line-up-2 (KIC77A/B/C/D/E16~50T2)

Detecting Voltage	KIC77A16~50T2		KIC77B16~50T2		KIC77C16~50T2		KIC77D16~50T2		KIC77E16~50T2	
	Item	Marking	Item	Marking	Item	Marking	Item	Marking	Item	Marking
1.6V	KIC77A16T2	P16	KIC77B16T2	Q16	KIC77C16T2	R16	KIC77D16T2	S16	KIC77E16T2	T16
1.7V	KIC77A17T2	P17	KIC77B17T2	Q17	KIC77C17T2	R17	KIC77D17T2	S17	KIC77E17T2	T17
1.8V	KIC77A18T2	P18	KIC77B18T2	Q18	KIC77C18T2	R18	KIC77D18T2	S18	KIC77E18T2	T18
1.9V	KIC77A19T2	P19	KIC77B19T2	Q19	KIC77C19T2	R19	KIC77D19T2	S19	KIC77E19T2	T19
2.0V	KIC77A20T2	P20	KIC77B20T2	Q20	KIC77C20T2	R20	KIC77D20T2	S20	KIC77E20T2	T20
2.1V	KIC77A21T2	P21	KIC77B21T2	Q21	KIC77C21T2	R21	KIC77D21T2	S21	KIC77E21T2	T21
2.2V	KIC77A22T2	P22	KIC77B22T2	Q22	KIC77C22T2	R22	KIC77D22T2	S22	KIC77E22T2	T22
2.3V	KIC77A23T2	P23	KIC77B23T2	Q23	KIC77C23T2	R23	KIC77D23T2	S23	KIC77E23T2	T23
2.4V	KIC77A24T2	P24	KIC77B24T2	Q24	KIC77C24T2	R24	KIC77D24T2	S24	KIC77E24T2	T24
2.5V	KIC77A25T2	P25	KIC77B25T2	Q25	KIC77C25T2	R25	KIC77D25T2	S25	KIC77E25T2	T25
2.6V	KIC77A26T2	P26	KIC77B26T2	Q26	KIC77C26T2	R26	KIC77D26T2	S26	KIC77E26T2	T26
2.63V	KIC77A263T2	P2F	KIC77B263T2	Q2F	KIC77C263T2	R2F	KIC77D263T2	S2F	KIC77E263T2	T2F
2.7V	KIC77A27T2	P27	KIC77B27T2	Q27	KIC77C27T2	R27	KIC77D27T2	S27	KIC77E27T2	T27
2.8V	KIC77A28T2	P28	KIC77B28T2	Q28	KIC77C28T2	R28	KIC77D28T2	S28	KIC77E28T2	T28
2.9V	KIC77A29T2	P29	KIC77B29T2	Q29	KIC77C29T2	R29	KIC77D29T2	S29	KIC77E29T2	T29
2.93V	KIC77A293T2	P2I	KIC77B293T2	Q2I	KIC77C293T2	R2I	KIC77D293T2	S2I	KIC77E293T2	T2I
3.0V	KIC77A30T2	P30	KIC77B30T2	Q30	KIC77C30T2	R30	KIC77D30T2	S30	KIC77E30T2	T30
3.08V	KIC77A308T2	P3Z	KIC77B308T2	Q3Z	KIC77C308T2	R3Z	KIC77D308T2	S3Z	KIC77E308T2	T3Z
3.1V	KIC77A31T2	P31	KIC77B31T2	Q31	KIC77C31T2	R31	KIC77D31T2	S31	KIC77E31T2	T31
3.2V	KIC77A32T2	P32	KIC77B32T2	Q32	KIC77C32T2	R32	KIC77D32T2	S32	KIC77E32T2	T32
3.3V	KIC77A33T2	P33	KIC77B33T2	Q33	KIC77C33T2	R33	KIC77D33T2	S33	KIC77E33T2	T33
3.4V	KIC77A34T2	P34	KIC77B34T2	Q34	KIC77C34T2	R34	KIC77D34T2	S34	KIC77E34T2	T34
3.5V	KIC77A35T2	P35	KIC77B35T2	Q35	KIC77C35T2	R35	KIC77D35T2	S35	KIC77E35T2	T35
3.6V	KIC77A36T2	P36	KIC77B36T2	Q36	KIC77C36T2	R36	KIC77D36T2	S36	KIC77E36T2	T36
3.7V	KIC77A37T2	P37	KIC77B37T2	Q37	KIC77C37T2	R37	KIC77D37T2	S37	KIC77E37T2	T37
3.8V	KIC77A38T2	P38	KIC77B38T2	Q38	KIC77C38T2	R38	KIC77D38T2	S38	KIC77E38T2	T38
3.9V	KIC77A39T2	P39	KIC77B39T2	Q39	KIC77C39T2	R39	KIC77D39T2	S39	KIC77E39T2	T39
4.0V	KIC77A40T2	P40	KIC77B40T2	Q40	KIC77C40T2	R40	KIC77D40T2	S40	KIC77E40T2	T40
4.1V	KIC77A41T2	P41	KIC77B41T2	Q41	KIC77C41T2	R41	KIC77D41T2	S41	KIC77E41T2	T41
4.2V	KIC77A42T2	P42	KIC77B42T2	Q42	KIC77C42T2	R42	KIC77D42T2	S42	KIC77E42T2	T42
4.3V	KIC77A43T2	P43	KIC77B43T2	Q43	KIC77C43T2	R43	KIC77D43T2	S43	KIC77E43T2	T43
4.38V	KIC77A438T2	P4C	KIC77B438T2	Q4C	KIC77C438T2	R4C	KIC77D438T2	S4C	KIC77E438T2	T4C
4.4V	KIC77A44T2	P44	KIC77B44T2	Q44	KIC77C44T2	R44	KIC77D44T2	S44	KIC77E44T2	T44
4.5V	KIC77A45T2	P45	KIC77B45T2	Q45	KIC77C45T2	R45	KIC77D45T2	S45	KIC77E45T2	T45
4.6V	KIC77A46T2	P46	KIC77B46T2	Q46	KIC77C46T2	R46	KIC77D46T2	S46	KIC77E46T2	T46
4.63V	KIC77A463T2	P4F	KIC77B463T2	Q4F	KIC77C463T2	R4F	KIC77D463T2	S4F	KIC77E463T2	T4F
4.7V	KIC77A47T2	P47	KIC77B47T2	Q47	KIC77C47T2	R47	KIC77D47T2	S47	KIC77E47T2	T47
4.8V	KIC77A48T2	P48	KIC77B48T2	Q48	KIC77C48T2	R48	KIC77D48T2	S48	KIC77E48T2	T48
4.9V	KIC77A49T2	P49	KIC77B49T2	Q49	KIC77C49T2	R49	KIC77D49T2	S49	KIC77E49T2	T49
5.0V	KIC77A50T2	P50	KIC77B50T2	Q50	KIC77C50T2	R50	KIC77D50T2	S50	KIC77E50T2	T50

KIC77A/B/C/D/E16~50T/T2/M/M2

Line-up-3 (KIC77A/B/C/D/E16~50M)

Detecting Voltage	KIC77A16~50M		KIC77B16~50M		KIC77C16~50M		KIC77D16~50M		KIC77E16~50M	
	Item	Marking	Item	Marking	Item	Marking	Item	Marking	Item	Marking
1.6V	KIC77A16M	A16	KIC77B16M	B16	KIC77C16M	C16	KIC77D16M	D16	KIC77E16M	E16
1.7V	KIC77A17M	A17	KIC77B17M	B17	KIC77C17M	C17	KIC77D17M	D17	KIC77E17M	E17
1.8V	KIC77A18M	A18	KIC77B18M	B18	KIC77C18M	C18	KIC77D18M	D18	KIC77E18M	E18
1.9V	KIC77A19M	A19	KIC77B19M	B19	KIC77C19M	C19	KIC77D19M	D19	KIC77E19M	E19
2.0V	KIC77A20M	A20	KIC77B20M	B20	KIC77C20M	C20	KIC77D20M	D20	KIC77E20M	E20
2.1V	KIC77A21M	A21	KIC77B21M	B21	KIC77C21M	C21	KIC77D21M	D21	KIC77E21M	E21
2.2V	KIC77A22M	A22	KIC77B22M	B22	KIC77C22M	C22	KIC77D22M	D22	KIC77E22M	E22
2.3V	KIC77A23M	A23	KIC77B23M	B23	KIC77C23M	C23	KIC77D23M	D23	KIC77E23M	E23
2.4V	KIC77A24M	A24	KIC77B24M	B24	KIC77C24M	C24	KIC77D24M	D24	KIC77E24M	E24
2.5V	KIC77A25M	A25	KIC77B25M	B25	KIC77C25M	C25	KIC77D25M	D25	KIC77E25M	E25
2.6V	KIC77A26M	A26	KIC77B26M	B26	KIC77C26M	C26	KIC77D26M	D26	KIC77E26M	E26
2.63V	KIC77A263M	A2F	KIC77B263M	B2F	KIC77C263M	C2F	KIC77D263M	D2F	KIC77E263M	E2F
2.7V	KIC77A27M	A27	KIC77B27M	B27	KIC77C27M	C27	KIC77D27M	D27	KIC77E27M	E27
2.8V	KIC77A28M	A28	KIC77B28M	B28	KIC77C28M	C28	KIC77D28M	D28	KIC77E28M	E28
2.9V	KIC77A29M	A29	KIC77B29M	B29	KIC77C29M	C29	KIC77D29M	D29	KIC77E29M	E29
2.93V	KIC77A293M	A2I	KIC77B293M	B2I	KIC77C293M	C2I	KIC77D293M	D2I	KIC77E293M	E2I
3.0V	KIC77A30M	A30	KIC77B30M	B30	KIC77C30M	C30	KIC77D30M	D30	KIC77E30M	E30
3.08V	KIC77A308M	A3Z	KIC77B308M	B3Z	KIC77C308M	C3Z	KIC77D308M	D3Z	KIC77E308M	E3Z
3.1V	KIC77A31M	A31	KIC77B31M	B31	KIC77C31M	C31	KIC77D31M	D31	KIC77E31M	E31
3.2V	KIC77A32M	A32	KIC77B32M	B32	KIC77C32M	C32	KIC77D32M	D32	KIC77E32M	E32
3.3V	KIC77A33M	A33	KIC77B33M	B33	KIC77C33M	C33	KIC77D33M	D33	KIC77E33M	E33
3.4V	KIC77A34M	A34	KIC77B34M	B34	KIC77C34M	C34	KIC77D34M	D34	KIC77E34M	E34
3.5V	KIC77A35M	A35	KIC77B35M	B35	KIC77C35M	C35	KIC77D35M	D35	KIC77E35M	E35
3.6V	KIC77A36M	A36	KIC77B36M	B36	KIC77C36M	C36	KIC77D36M	D36	KIC77E36M	E36
3.7V	KIC77A37M	A37	KIC77B37M	B37	KIC77C37M	C37	KIC77D37M	D37	KIC77E37M	E37
3.8V	KIC77A38M	A38	KIC77B38M	B38	KIC77C38M	C38	KIC77D38M	D38	KIC77E38M	E38
3.9V	KIC77A39M	A39	KIC77B39M	B39	KIC77C39M	C39	KIC77D39M	D39	KIC77E39M	E39
4.0V	KIC77A40M	A40	KIC77B40M	B40	KIC77C40M	C40	KIC77D40M	D40	KIC77E40M	E40
4.1V	KIC77A41M	A41	KIC77B41M	B41	KIC77C41M	C41	KIC77D41M	D41	KIC77E41M	E41
4.2V	KIC77A42M	A42	KIC77B42M	B42	KIC77C42M	C42	KIC77D42M	D42	KIC77E42M	E42
4.3V	KIC77A43M	A43	KIC77B43M	B43	KIC77C43M	C43	KIC77D43M	D43	KIC77E43M	E43
4.38V	KIC77A438M	A4C	KIC77B438M	B4C	KIC77C438M	C4C	KIC77D438M	D4C	KIC77E438M	E4C
4.4V	KIC77A44M	A44	KIC77B44M	B44	KIC77C44M	C44	KIC77D44M	D44	KIC77E44M	E44
4.5V	KIC77A45M	A45	KIC77B45M	B45	KIC77C45M	C45	KIC77D45M	D45	KIC77E45M	E45
4.6V	KIC77A46M	A46	KIC77B46M	B46	KIC77C46M	C46	KIC77D46M	D46	KIC77E46M	E46
4.63V	KIC77A463M	A4F	KIC77B463M	B4F	KIC77C463M	C4F	KIC77D463M	D4F	KIC77E463M	E4F
4.7V	KIC77A47M	A47	KIC77B47M	B47	KIC77C47M	C47	KIC77D47M	D47	KIC77E47M	E47
4.8V	KIC77A48M	A48	KIC77B48M	B48	KIC77C48M	C48	KIC77D48M	D48	KIC77E48M	E48
4.9V	KIC77A49M	A49	KIC77B49M	B49	KIC77C49M	C49	KIC77D49M	D49	KIC77E49M	E49
5.0V	KIC77A50M	A50	KIC77B50M	B50	KIC77C50M	C50	KIC77D50M	D50	KIC77E50M	E50

KIC77A/B/C/D/E16~50T/T2/M/M2

Line-up-4 (KIC77A/B/C/D/E16~50M2)

Detecting Voltage	KIC77A16~50M2		KIC77B16~50M2		KIC77C16~50M2		KIC77D16~50M2		KIC77E16~50M2	
	Item	Marking	Item	Marking	Item	Marking	Item	Marking	Item	Marking
1.6V	KIC77A16M2	P16	KIC77B16M2	Q16	KIC77C16M2	R16	KIC77D16M2	S16	KIC77E16M2	T16
1.7V	KIC77A17M2	P17	KIC77B17M2	Q17	KIC77C17M2	R17	KIC77D17M2	S17	KIC77E17M2	T17
1.8V	KIC77A18M2	P18	KIC77B18M2	Q18	KIC77C18M2	R18	KIC77D18M2	S18	KIC77E18M2	T18
1.9V	KIC77A19M2	P19	KIC77B19M2	Q19	KIC77C19M2	R19	KIC77D19M2	S19	KIC77E19M2	T19
2.0V	KIC77A20M2	P20	KIC77B20M2	Q20	KIC77C20M2	R20	KIC77D20M2	S20	KIC77E20M2	T20
2.1V	KIC77A21M2	P21	KIC77B21M2	Q21	KIC77C21M2	R21	KIC77D21M2	S21	KIC77E21M2	T21
2.2V	KIC77A22M2	P22	KIC77B22M2	Q22	KIC77C22M2	R22	KIC77D22M2	S22	KIC77E22M2	T22
2.3V	KIC77A23M2	P23	KIC77B23M2	Q23	KIC77C23M2	R23	KIC77D23M2	S23	KIC77E23M2	T23
2.4V	KIC77A24M2	P24	KIC77B24M2	Q24	KIC77C24M2	R24	KIC77D24M2	S24	KIC77E24M2	T24
2.5V	KIC77A25M2	P25	KIC77B25M2	Q25	KIC77C25M2	R25	KIC77D25M2	S25	KIC77E25M2	T25
2.6V	KIC77A26M2	P26	KIC77B26M2	Q26	KIC77C26M2	R26	KIC77D26M2	S26	KIC77E26M2	T26
2.63V	KIC77A263M2	P2F	KIC77B263M2	Q2F	KIC77C263M2	R2F	KIC77D263M2	S2F	KIC77E263M2	T2F
2.7V	KIC77A27M2	P27	KIC77B27M2	Q27	KIC77C27M2	R27	KIC77D27M2	S27	KIC77E27M2	T27
2.8V	KIC77A28M2	P28	KIC77B28M2	Q28	KIC77C28M2	R28	KIC77D28M2	S28	KIC77E28M2	T28
2.9V	KIC77A29M2	P29	KIC77B29M2	Q29	KIC77C29M2	R29	KIC77D29M2	S29	KIC77E29M2	T29
2.93V	KIC77A293M2	P2I	KIC77B293M2	Q2I	KIC77C293M2	R2I	KIC77D293M2	S2I	KIC77E293M2	T2I
3.0V	KIC77A30M2	P30	KIC77B30M2	Q30	KIC77C30M2	R30	KIC77D30M2	S30	KIC77E30M2	T30
3.08V	KIC77A308M2	P3Z	KIC77B308M2	Q3Z	KIC77C308M2	R3Z	KIC77D308M2	S3Z	KIC77E308M2	T3Z
3.1V	KIC77A31M2	P31	KIC77B31M2	Q31	KIC77C31M2	R31	KIC77D31M2	S31	KIC77E31M2	T31
3.2V	KIC77A32M2	P32	KIC77B32M2	Q32	KIC77C32M2	R32	KIC77D32M2	S32	KIC77E32M2	T32
3.3V	KIC77A33M2	P33	KIC77B33M2	Q33	KIC77C33M2	R33	KIC77D33M2	S33	KIC77E33M2	T33
3.4V	KIC77A34M2	P34	KIC77B34M2	Q34	KIC77C34M2	R34	KIC77D34M2	S34	KIC77E34M2	T34
3.5V	KIC77A35M2	P35	KIC77B35M2	Q35	KIC77C35M2	R35	KIC77D35M2	S35	KIC77E35M2	T35
3.6V	KIC77A36M2	P36	KIC77B36M2	Q36	KIC77C36M2	R36	KIC77D36M2	S36	KIC77E36M2	T36
3.7V	KIC77A37M2	P37	KIC77B37M2	Q37	KIC77C37M2	R37	KIC77D37M2	S37	KIC77E37M2	T37
3.8V	KIC77A38M2	P38	KIC77B38M2	Q38	KIC77C38M2	R38	KIC77D38M2	S38	KIC77E38M2	T38
3.9V	KIC77A39M2	P39	KIC77B39M2	Q39	KIC77C39M2	R39	KIC77D39M2	S39	KIC77E39M2	T39
4.0V	KIC77A40M2	P40	KIC77B40M2	Q40	KIC77C40M2	R40	KIC77D40M2	S40	KIC77E40M2	T40
4.1V	KIC77A41M2	P41	KIC77B41M2	Q41	KIC77C41M2	R41	KIC77D41M2	S41	KIC77E41M2	T41
4.2V	KIC77A42M2	P42	KIC77B42M2	Q42	KIC77C42M2	R42	KIC77D42M2	S42	KIC77E42M2	T42
4.3V	KIC77A43M2	P43	KIC77B43M2	Q43	KIC77C43M2	R43	KIC77D43M2	S43	KIC77E43M2	T43
4.38V	KIC77A438M2	P4C	KIC77B438M2	Q4C	KIC77C438M2	R4C	KIC77D438M2	S4C	KIC77E438M2	T4C
4.4V	KIC77A44M2	P44	KIC77B44M2	Q44	KIC77C44M2	R44	KIC77D44M2	S44	KIC77E44M2	T44
4.5V	KIC77A45M2	P45	KIC77B45M2	Q45	KIC77C45M2	R45	KIC77D45M2	S45	KIC77E45M2	T45
4.6V	KIC77A46M2	P46	KIC77B46M2	Q46	KIC77C46M2	R46	KIC77D46M2	S46	KIC77E46M2	T46
4.63V	KIC77A463M2	P4F	KIC77B463M2	Q4F	KIC77C463M2	R4F	KIC77D463M2	S4F	KIC77E463M2	T4F
4.7V	KIC77A47M2	P47	KIC77B47M2	Q47	KIC77C47M2	R47	KIC77D47M2	S47	KIC77E47M2	T47
4.8V	KIC77A48M2	P48	KIC77B48M2	Q48	KIC77C48M2	R48	KIC77D48M2	S48	KIC77E48M2	T48
4.9V	KIC77A49M2	P49	KIC77B49M2	Q49	KIC77C49M2	R49	KIC77D49M2	S49	KIC77E49M2	T49
5.0V	KIC77A50M2	P50	KIC77B50M2	Q50	KIC77C50M2	R50	KIC77D50M2	S50	KIC77E50M2	T50

KIC77A/B/C/D/E16~50T/T2/M/M2

Absolute Maximum Ratings (Ta=25°C)

ITEM	SYMBOL	RATING		UNITS
Supply voltage	$V_{DD\ MAX.}$	-0.3 ~ +7		V
Output voltage	V_{OUT}	-0.3 ~ +7		V
Input current (I_{DD})	I_{DD}	20		mA
Output current	I_{OUT}	20		mA
Power dissipation	P_D	TSM	900 *Note1)	mW
		SOT-23	350 *Note2)	
Operating temperature	T_{OPR}	-40 ~ +105		°C
Storage temperature	T_{STG}	-65 ~ +150		°C

* Note 1) Package mounted on a ceramix board (600mm²×0.8mm)

* Note 2) Package mounted on 99.5% Alumina (10mm×8mm×6mm)

Electrical Characteristics (Unless otherwise specified Ta=25°C)

PARAMETER	SYMBOL	TEST CONDITION	MIN.	TYP.	MAX.	UNITS	CIRCUIT	
Operating voltage	V_{DD}	Ta = 0 ~ 70°C	1.0	-	6.0	V	(1)	
		Ta = -40 ~ 105°C	1.1	-	6.0			
Supply Current	I_{DD}	$V_{DD} = V_{TH} + 1V$	-	0.5	2.0	μA	(2)	
Reset Threshold	V_{TH}	$V_{TH}=4.63V$	Ta=25°C	4.584	4.630	4.676	V	(1)
			Ta=-40 to 85°C	4.500	-	4.750		
			Ta=85 to 105°C	4.400	-	4.860		
		$V_{TH}=4.38V$	Ta=25°C	4.336	4.380	4.424		
			Ta=-40 to 85°C	4.250	-	4.500		
			Ta=85 to 105°C	4.160	-	4.560		
		$V_{TH}=3.08V$	Ta=25°C	3.049	3.080	3.111		
			Ta=-40 to 85°C	3.000	-	3.150		
			Ta=85 to 105°C	2.920	-	3.230		
		$V_{TH}=2.93V$	Ta=25°C	2.901	2.930	2.959		
			Ta=-40 to 85°C	2.850	-	3.000		
			Ta=85 to 105°C	2.780	-	3.080		
		$V_{TH}=2.63V$	Ta=25°C	2.604	2.630	2.656		
			Ta=-40 to 85°C	2.550	-	2.700		
			Ta=85 to 105°C	2.500	-	2.760		
$V_{TH}=1.6\sim 5.0$ V (0.1V step)	Ta=25°C	-1.0	-	1.0	%			
	Ta=-40 to 85°C	-2.5	-	2.5				
	Ta=85 to 105°C	-5.0	-	5.0				
Reset Threshold Temp. Coefficient	$V_{TH/\Delta T}$	-	-	30	-	ppm/°C	(1)	
RST output voltage Low	V_{OL}	$V_{DD}=V_{TH}-0.1V, I_{sink}=1.2mA$ $V_{TH} \square 3.08V$	-	-	0.3	V	(3)	
		$V_{DD}=V_{TH}-0.1V, I_{sink}=3.2mA$ $V_{TH} > 3.08V$	-	-	0.4			

KIC77A/B/C/D/E16~50T/T2/M/M2

PARAMETER	SYMBOL	TEST CONDITION	MIN.	TYP.	MAX.	UNITS	CIRCUIT	
RST output voltage High (active L type)	V _{OH}	V _{DD} =V _{TH} +1V, I _{source} =500μ A V _{TH} □3.08V	0.8 *V _{DD}	-	-	V	(3)	
		V _{DD} =V _{TH} +1V, I _{source} =800μ A V _{TH} > 3.08V	V _{DD} -1.5					
Reset active time timeout period	t _{del}	A	Ta=-40 to 85 °C	140	240	310	ms	(5)
			Ta=85 to 105 °C	100	-	840		
		B	Ta=-40 to 85 °C	35	50	65		
			Ta=85 to 105 °C	25	-	98		
		C	Ta=-40 to 85 °C	70	100	130		
			Ta=85 to 105 °C	49	-	195		
		D	Ta=-40 to 85 °C	140	200	260		
			Ta=85 to 105 °C	98	-	390		
E	Ta=-40 to 85 °C	280	400	520				
	Ta=85 to 105 °C	196	-	780				
V _{DD} to Reset Delay	t _{TH}	V _{DD} =(V _{TH} +1V) to (V _{TH} -100mV)	-	20	-	μs	(5)	
Output Leakage Current	I _{LEAK}	V _{DD} =V _{RST} =5.5V	-	-	0.1	μA	(4)	

KIC77A/B/C/D/E16~50T/T2/M/M2

Test circuits

(1)

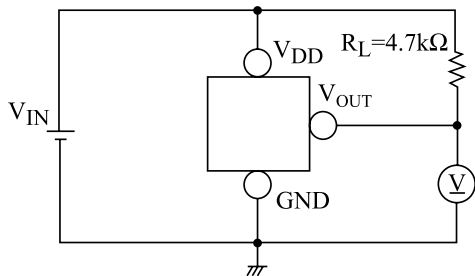

(2)

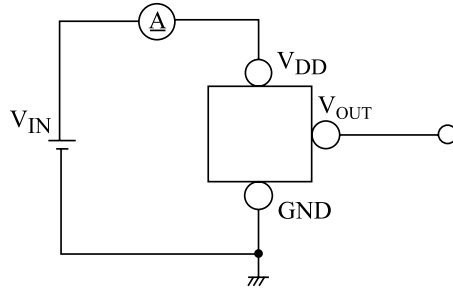

(3)

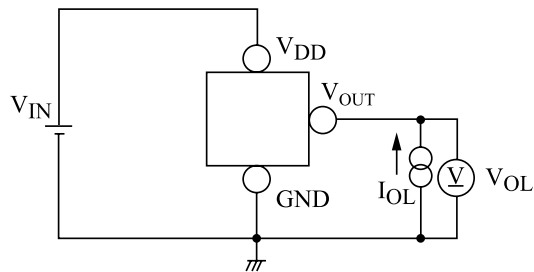

(4)

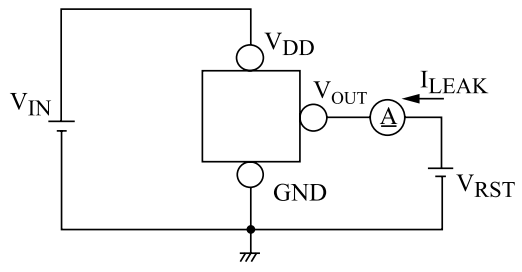

(5)

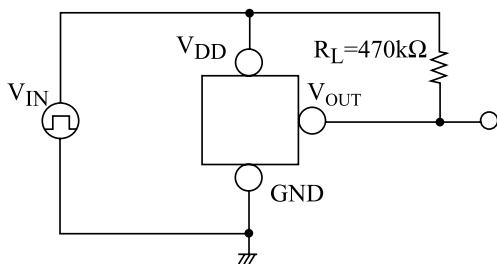

V_{DD} to reset Delay

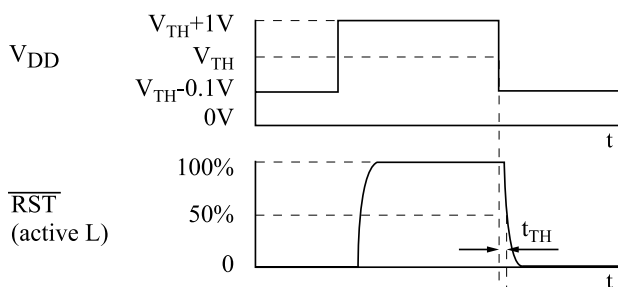

Reset active timeout period

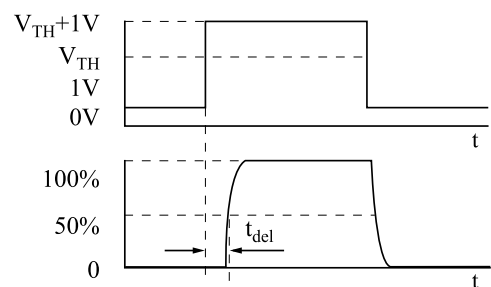

KIC77A/B/C/D/E16~50T/T2/M/M2

Timing Chart

※ $V_{DD} < V_{TH}$ region is, it will be operating limits, The output is undefined.

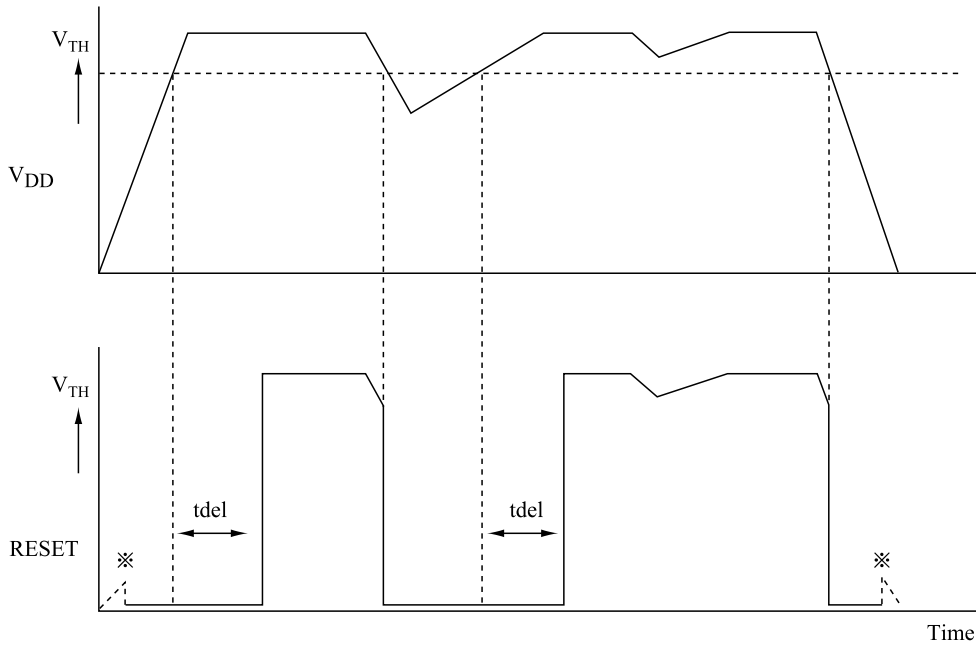

Application Circuits

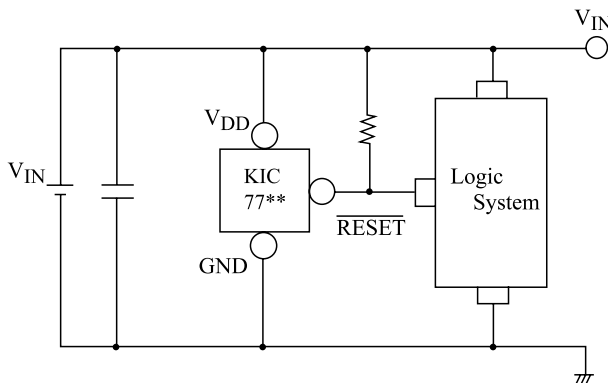

Note

1. Please note that there is any possibility of circuit oscillation when resistance put in the line V_{IN} .
2. Load current and load resistance should be abjusted, which not over power dissipation level.

$$P_D > (V_{DD} - V_{OH}) \cdot I_{OH}$$

$$P_D > V_{OL} \cdot I_{OL}$$

3. We shall not be liable for any trouble or damage caused by using this circuit
4. In the event a problem which may affect industrial property or any other rights of us or a third party is encountered during the use of information described in these circuit, Mitsumi Electric Co.,Ltd. shall not be liable for any such problem, nor grant a license therefore.

KIC77A/B/C/D/E16~50T/T2/M/M2

Typical Characteristics (Typical performance Characteristics 2.9V)

note : These are typical characteristics

Fig1. Detecting Voltage

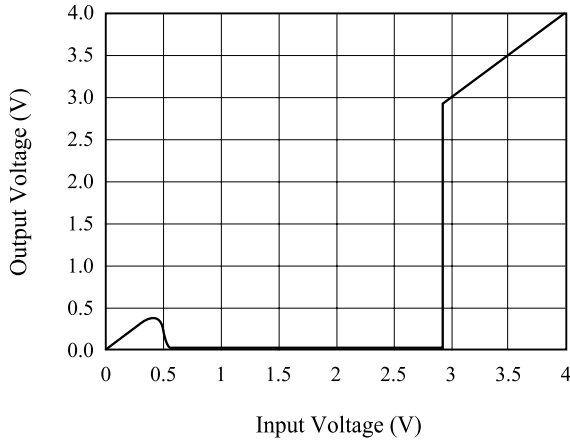

Fig2. Supply Current

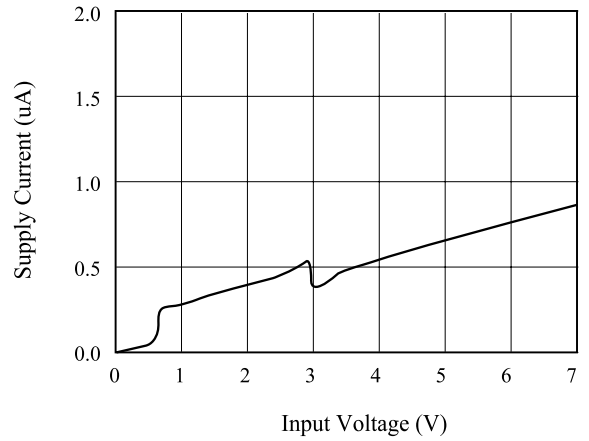

Fig3. Detecting Voltage vs Temperature

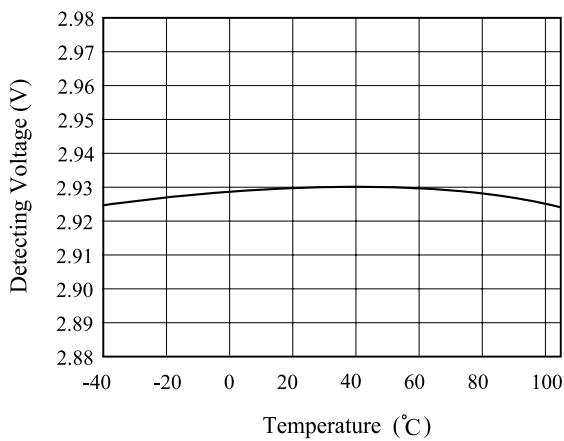

Fig4. Supply Current vs Temperature

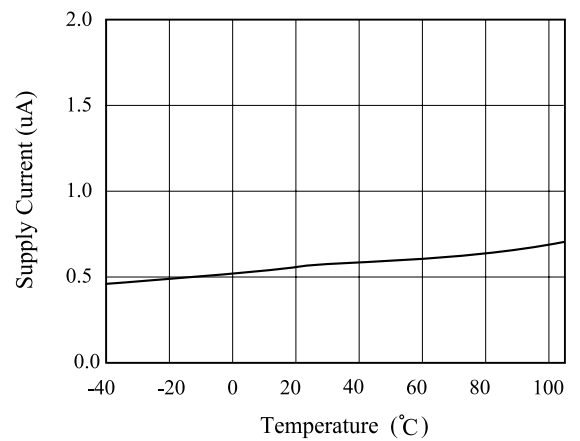

Fig5. Reset Active Timeout Period vs Temperature

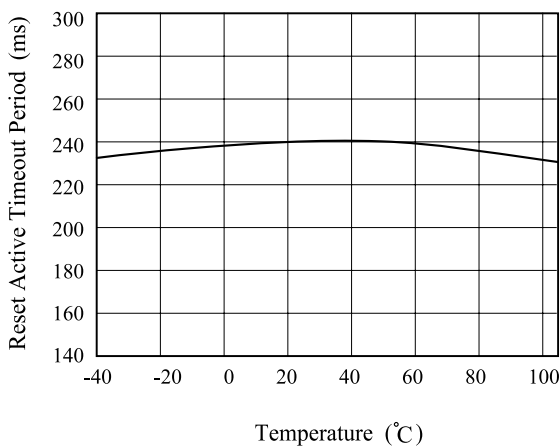

Fig6. V_{DD} to Reset Delay vs Temperature

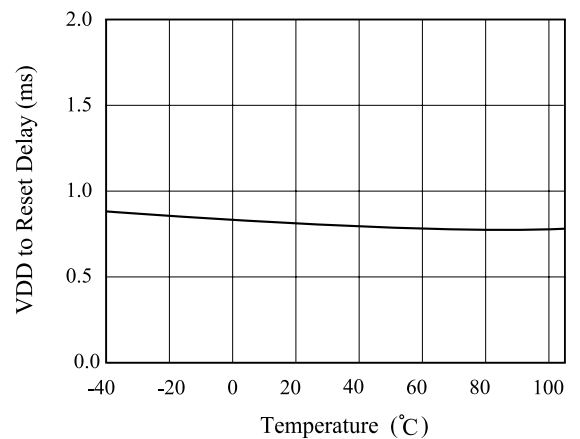

Fig7. "L" Output Voltage vs Temperature

