

Cree® XLamp® CXB1512 LED



PRODUCT DESCRIPTION

The XLamp® CXB1512 LED Array is a member of the second generation of the CXA family that delivers up to 30% higher efficacy and up to 20% higher lumens than the first generation in the same LES. The higher performance second generation CXA LED Arrays provide a drop-in performance upgrade to existing CXA LED designs to shorten product development time. In addition, the CXB LEDs also allow lighting manufacturers to achieve the same or better performance with a smaller LES, enabling a smaller, more impactful luminaire. Available in 2-step, 3-step and 5-step EasyWhite® bins, the CXB1512 LED delivers high lumen output and high efficacy in a single, easy-to-use package that eliminates the need for reflow soldering.

The [CX Family LED Design Guide](#) provides basic information on the requirements to use the CXB1512 LED successfully in luminaire designs.

FEATURES

- 9-mm optical source
- Mechanical and optical design consistent with other CXA15 and CXB15 LEDs
- Available in 70-, 80- and 90-minimum CRI options
- Cree EasyWhite® 2-, 3- and 5-step binning
- Forward voltage options: 18-V class & 36-V class
- 85 °C binning and characterization
- Extremely uniform color over viewing angle
- Top-side solder connections
- Thermocouple attach point
- NEMA SSL-3 2011 standard flux bins
- RoHS and REACH compliant
- UL® recognized component (E349212)

TABLE OF CONTENTS

Characteristics	2
Operating Limits.....	3
Flux Characteristics, EasyWhite® Order Codes and Bins - 18 V.....	4
Flux Characteristics, EasyWhite® Order Codes and Bins - 36 V.....	6
Relative Spectral Power Distribution	8
Electrical Characteristics.....	9
Relative Luminous Flux.....	10
Typical Spatial Distribution.....	12
Performance Groups - Brightness	12
Performance Groups - Chromaticity	13
Cree EasyWhite® Bins Plotted on the 1931 CIE Color Space	14
Bin and Order Code Formats	16
Mechanical Dimensions	16
Thermal Design.....	17
Notes	19
Packaging.....	20



CHARACTERISTICS

Characteristics	Unit	Minimum	Typical	Maximum
Viewing angle (FWHM)	degrees		115	
ESD withstand voltage (HBM per Mil-Std-883D)	V			8000
DC forward current (18 V)	mA			1200*
DC forward current (36 V)	mA			600*
Reverse current (18 V, 36 V)	mA			0.1
Forward voltage (18 V, @ 700 mA, 85 °C)	V		17.2	19
Forward voltage (36 V, @ 350 mA, 85 °C)	V		34.3	38

* Refer to the Operating Limits section.

OPERATING LIMITS

The maximum current rating of the CXB1512 is dependent on the case temperature (T_c) when the LED has reached thermal equilibrium under steady-state operation. The graphs shown below assume that the system design employs good thermal management (thermal interface material and heat sink) and may vary when poor thermal management is employed. Please refer to the Mechanical Dimensions section on page 16 for the location of the T_c measurement point.

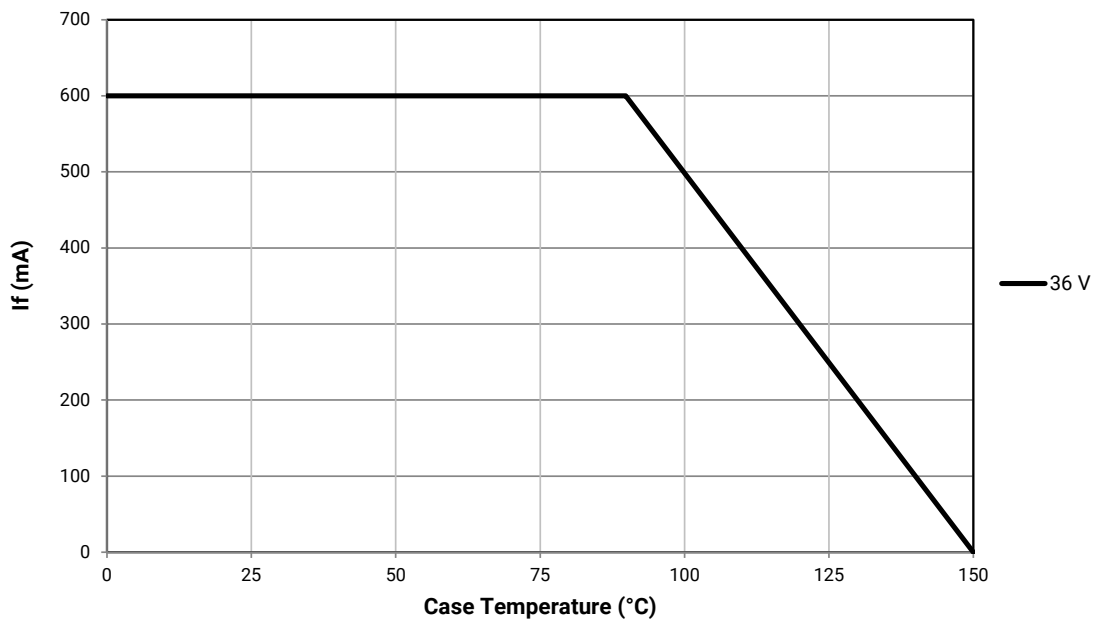
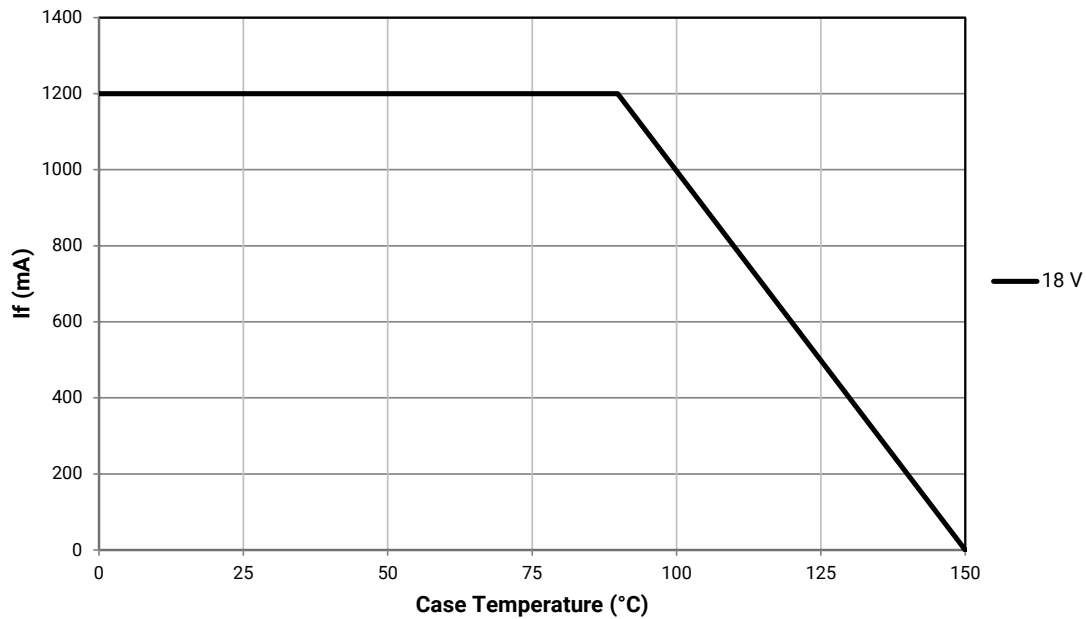

FLUX CHARACTERISTICS, EASYWHITE® ORDER CODES AND BINS - 18 V ($I_F = 700 \text{ mA}$, $T_J = 85 \text{ °C}$)

The following table provides order codes for XLamp CXB1512 LEDs. For a complete description of the order code nomenclature, please see the Bin and Order Code Formats section (page 16).

Nominal CCT	CRI*		Minimum Luminous Flux			2-Step		3-Step				5-Step	
	Min	Typ	Group	Flux (lm) @ 85 °C	Flux (lm) @ 25 °C**	Group	Order Code	Group	Order Code	Group	Order Code	Group	Order Code
6500 K	70	---	N4	1710	1871							65E	CXB1512-0000-000F0BN465E
			P2	1830	2002								CXB1512-0000-000F0BP265E
	80	---	N2	1590	1739							65E	CXB1512-0000-000F0HN265E
			N4	1710	1871								CXB1512-0000-000F0HN465E
5700 K	70	---	N4	1710	1871							57E	CXB1512-0000-000F0BN457E
			P2	1830	2002								CXB1512-0000-000F0BP257E
	80	---	N2	1590	1739							57E	CXB1512-0000-000F0HN257E
			N4	1710	1871								CXB1512-0000-000F0HN457E
5000 K	70	---	N4	1710	1871							50E	CXB1512-0000-000F0BN450E
			P2	1830	2002								CXB1512-0000-000F0BP250E
	80	---	N2	1590	1739			50G	CXB1512-0000-000F0HN250G			50E	CXB1512-0000-000F0HN250E
			N4	1710	1871								CXB1512-0000-000F0HN450E
	90	92	M4	1485	1625			50G	CXB1512-0000-000F0UM450G				
			N2	1590	1739								
4000 K	70	---	N4	1710	1871							40E	CXB1512-0000-000F0BN440E
			P2	1830	2002								CXB1512-0000-000F0BP240E
	80	---	N2	1590	1739	40H	CXB1512-0000-000F0HN240H	40G	CXB1512-0000-000F0HN240G				
			N4	1710	1871								
	90	92	M2	1380	1510	40H	CXB1512-0000-000F0UM240H	40G	CXB1512-0000-000F0UM240G				
			M4	1485	1625								

- Notes**
- Cree maintains a tolerance of $\pm 7\%$ on flux and power measurements, ± 0.005 on chromaticity (CCx, CCy) measurements and a tolerance of ± 2 on CRI measurements. See the Measurements section (page 21).
 - Cree XLamp CXB1512 LED order codes specify only a minimum flux bin and not a maximum. Cree may ship reels in flux bins higher than the minimum specified by the order code without advance notice. Shipments will always adhere to the chromaticity bin restrictions specified by the order code.
 - * For 80 CRI minimum LEDs, CRI R9 minimum is 0 with a ± 2 tolerance. For 90 CRI minimum LEDs, CRI R9 typical is 60.
 - ** Flux values @ 25 °C are calculated and for reference only.

FLUX CHARACTERISTICS, EASYWHITE® ORDER CODES AND BINS - 18 V (I_F = 700 mA, T_J = 85 °C) - CONTINUED

Nominal CCT	CRI*		Minimum Luminous Flux			2-Step		3-Step				5-Step	
	Min	Typ	Group	Flux (lm) @ 85 °C	Flux (lm) @ 25 °C**	Group	Order Code	Group	Order Code	Group	Order Code	Group	Order Code
3500 K	80	---	N2	1590	1739	35H	CXB1512-0000-000F0HN235H	35G	CXB1512-0000-000F0HN235G				
			N4	1710	1871		CXB1512-0000-000F0HN435H		CXB1512-0000-000F0HN435G				
	90	92	K4	1290	1411	35H	CXB1512-0000-000F0UK435H	35G	CXB1512-0000-000F0UK435G				
			M2	1380	1510		CXB1512-0000-000F0UM235H		CXB1512-0000-000F0UM235G				
3000 K	80	---	M4	1485	1625	30H	CXB1512-0000-000F0HM430H	30G	CXB1512-0000-000F0HM430G				
			N2	1590	1739		CXB1512-0000-000F0HN230H		CXB1512-0000-000F0HN230G				
	90	92	K4	1290	1411	30H	CXB1512-0000-000F0UK430H	30G	CXB1512-0000-000F0UK430G				
			M2	1380	1510		CXB1512-0000-000F0UM230H		CXB1512-0000-000F0UM230G				
	90	92	J4	1120	1234			30Q		30U	CXB1512-0000-000F0UJ430U		
			K2	1200	1313				CXB1512-0000-000F0UK230Q		CXB1512-0000-000F0UK230U		
			K4	1290	1411			CXB1512-0000-000F0UK430Q		CXB1512-0000-000F0UK430U			
2700 K	80	---	M4	1485	1625	27H	CXB1512-0000-000F0HM427H	27G	CXB1512-0000-000F0HM427G				
			N2	1590	1739		CXB1512-0000-000F0HN227H		CXB1512-0000-000F0HN227G				
	90	92	K2	1200	1313	27H	CXB1512-0000-000F0UK227H	27G	CXB1512-0000-000F0UK227G				
			K4	1290	1411		CXB1512-0000-000F0UK427H		CXB1512-0000-000F0UK427G				

- Notes**
- Cree maintains a tolerance of ±7% on flux and power measurements, ±0.005 on chromaticity (CCx, CCy) measurements and a tolerance of ±2 on CRI measurements. See the Measurements section (page 21).
 - Cree XLamp CXB1512 LED order codes specify only a minimum flux bin and not a maximum. Cree may ship reels in flux bins higher than the minimum specified by the order code without advance notice. Shipments will always adhere to the chromaticity bin restrictions specified by the order code.
 - * For 80 CRI minimum LEDs, CRI R9 minimum is 0 with a ±2 tolerance. For 90 CRI minimum LEDs, CRI R9 typical is 60.
 - ** Flux values @ 25 °C are calculated and for reference only.

FLUX CHARACTERISTICS, EASYWHITE® ORDER CODES AND BINS - 36 V ($I_F = 350 \text{ mA}$, $T_J = 85 \text{ °C}$)

The following table provides order codes for XLamp CXB1512 LEDs. For a complete description of the order code nomenclature, please see the Bin and Order Code Formats section (page 16).

Nominal CCT	CRI*		Minimum Luminous Flux			2-Step		3-Step				5-Step	
	Min	Typ	Group	Flux (lm) @ 85 °C	Flux (lm) @ 25 °C**	Group	Order Code	Group	Order Code	Group	Order Code	Group	Order Code
6500 K	70	---	N4	1710	1871							65E	CXB1512-0000-000N0BN465E
			P2	1830	2002								CXB1512-0000-000N0BP265E
	80	---	N2	1590	1739							65E	CXB1512-0000-000N0HN265E
			N4	1710	1871								CXB1512-0000-000N0HN465E
5700 K	70	---	N4	1710	1871							57E	CXB1512-0000-000N0BN457E
			P2	1830	2002								CXB1512-0000-000N0BP257E
	80	---	N2	1590	1739							57E	CXB1512-0000-000N0HN257E
			N4	1710	1871								CXB1512-0000-000N0HN457E
5000 K	70	---	N4	1710	1871							50E	CXB1512-0000-000N0BN450E
			P2	1830	2002								CXB1512-0000-000N0BP250E
	80	---	N2	1590	1739			50G	CXB1512-0000-000N0HN250G			50E	CXB1512-0000-000N0HN250E
			N4	1710	1871								CXB1512-0000-000N0HN450E
	90	92	M4	1485	1625			50G	CXB1512-0000-000N0UM450G				
			N2	1590	1739								
4000 K	70	---	N4	1710	1871							40E	CXB1512-0000-000N0BN440E
			P2	1830	2002								CXB1512-0000-000N0BP240E
	80	---	N2	1590	1739	40H	CXB1512-0000-000N0HN240H	40G	CXB1512-0000-000N0HN240G				
			N4	1710	1871								
	90	92	M2	1380	1510	40H	CXB1512-0000-000N0UM240H	40G	CXB1512-0000-000N0UM240G				
			M4	1485	1625								

- Notes**
- Cree maintains a tolerance of $\pm 7\%$ on flux and power measurements, ± 0.005 on chromaticity (CCx, CCy) measurements and a tolerance of ± 2 on CRI measurements. See the Measurements section (page 21).
 - Cree XLamp CXB1512 LED order codes specify only a minimum flux bin and not a maximum. Cree may ship reels in flux bins higher than the minimum specified by the order code without advance notice. Shipments will always adhere to the chromaticity bin restrictions specified by the order code.
 - * For 80 CRI minimum LEDs, CRI R9 minimum is 0 with a ± 2 tolerance. For 90 CRI minimum LEDs, CRI R9 typical is 60.
 - ** Flux values @ 25 °C are calculated and for reference only.

FLUX CHARACTERISTICS, EASYWHITE® ORDER CODES AND BINS - 36 V (I_F = 350 mA, T_J = 85 °C) - CONTINUED

Nominal CCT	CRI*		Minimum Luminous Flux			2-Step		3-Step				5-Step			
	Min	Typ	Group	Flux (lm) @ 85 °C	Flux (lm) @ 25 °C**	Group	Order Code	Group	Order Code	Group	Order Code	Group	Order Code		
3500 K	80	---	N2	1590	1739	35H	CXB1512-0000-000N0HN235H	35G	CXB1512-0000-000N0HN235G						
			N4	1710	1871		CXB1512-0000-000N0HN435H		CXB1512-0000-000N0HN435G						
	90	92	K4	1290	1411	35H	CXB1512-0000-000N0UK435H	35G	CXB1512-0000-000N0UK435G						
			M2	1380	1510		CXB1512-0000-000N0UM235H		CXB1512-0000-000N0UM235G						
3000 K	80	---	M4	1485	1625	30H	CXB1512-0000-000N0HM430H	30G	CXB1512-0000-000N0HM430G						
			N2	1590	1739		CXB1512-0000-000N0HN230H		CXB1512-0000-000N0HN230G						
	90	92	K4	1290	1411	30H	CXB1512-0000-000N0UK430H	30G	CXB1512-0000-000N0UK430G						
			M2	1380	1510		CXB1512-0000-000N0UM230H		CXB1512-0000-000N0UM230G						
	90	92	J4	1120	1234			30Q		30U	CXB1512-0000-000N0UJ430U				
			K2	1200	1313						CXB1512-0000-000N0UK230Q				CXB1512-0000-000N0UK230U
			K4	1290	1411						CXB1512-0000-000N0UK430Q				CXB1512-0000-000N0UK430U
	2700 K	80	---	M4	1485	1625	27H	CXB1512-0000-000N0HM427H	27G	CXB1512-0000-000N0HM427G					
N2				1590	1739	CXB1512-0000-000N0HN227H		CXB1512-0000-000N0HN227G							
90		92	K2	1200	1313	27H	CXB1512-0000-000N0UK227H	27G	CXB1512-0000-000N0UK227G						
			K4	1290	1411		CXB1512-0000-000N0UK427H		CXB1512-0000-000N0UK427G						

- Notes**
- Cree maintains a tolerance of ±7% on flux and power measurements, ±0.005 on chromaticity (CCx, CCy) measurements and a tolerance of ±2 on CRI measurements. See the Measurements section (page 21).
 - Cree XLamp CXB1512 LED order codes specify only a minimum flux bin and not a maximum. Cree may ship reels in flux bins higher than the minimum specified by the order code without advance notice. Shipments will always adhere to the chromaticity bin restrictions specified by the order code.
 - * For 80 CRI minimum LEDs, CRI R9 minimum is 0 with a ±2 tolerance. For 90 CRI minimum LEDs, CRI R9 typical is 60.
 - ** Flux values @ 25 °C are calculated and for reference only.

RELATIVE SPECTRAL POWER DISTRIBUTION

The following graph is the result of a series of pulsed measurements at 700 mA for the 18-V CXB1512 LED and 350 mA for the 36-V CXB1512 LED and $T_j = 85\text{ }^\circ\text{C}$.

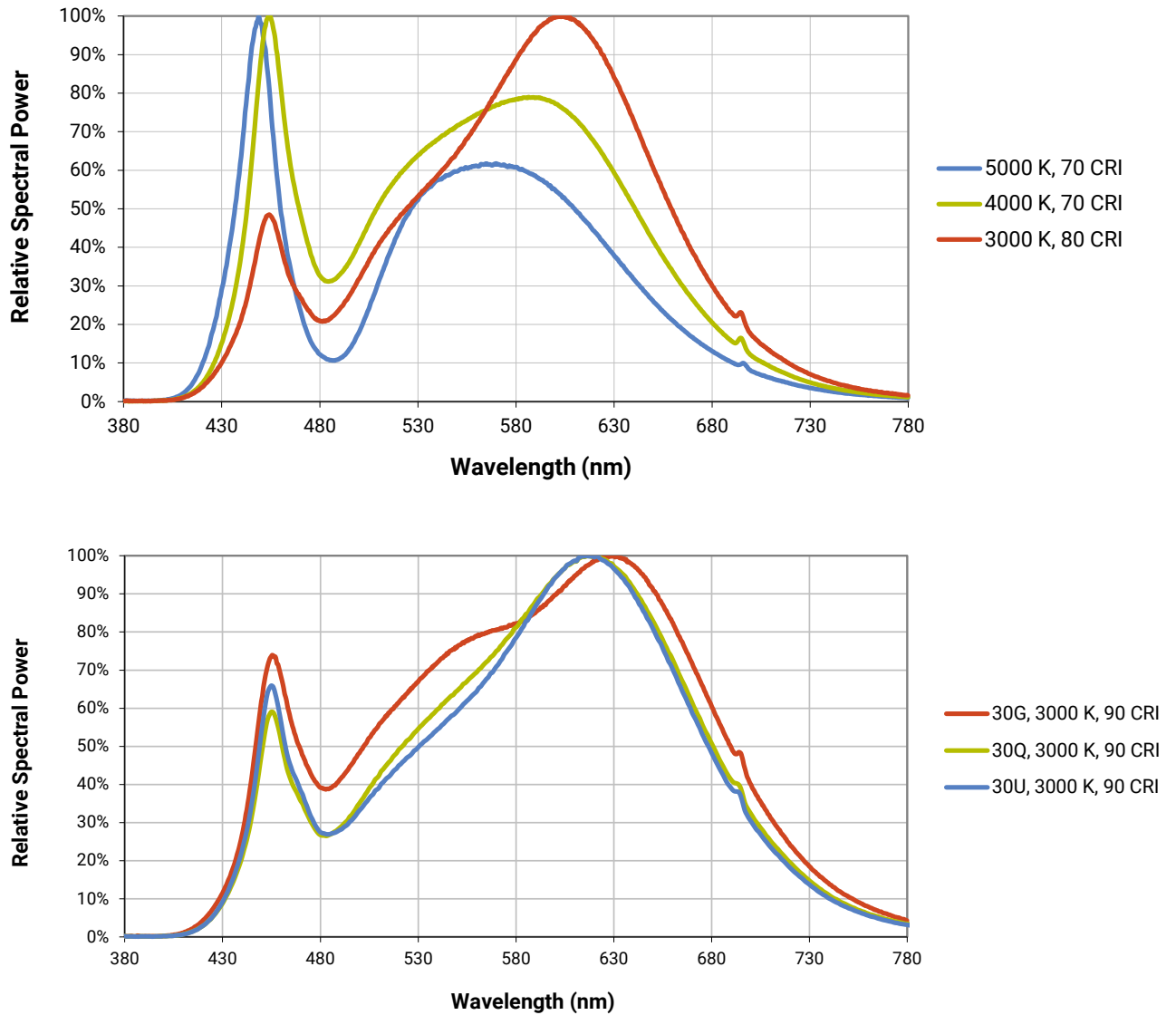

ELECTRICAL CHARACTERISTICS

The following graphs are the result of a series of steady-state measurements.

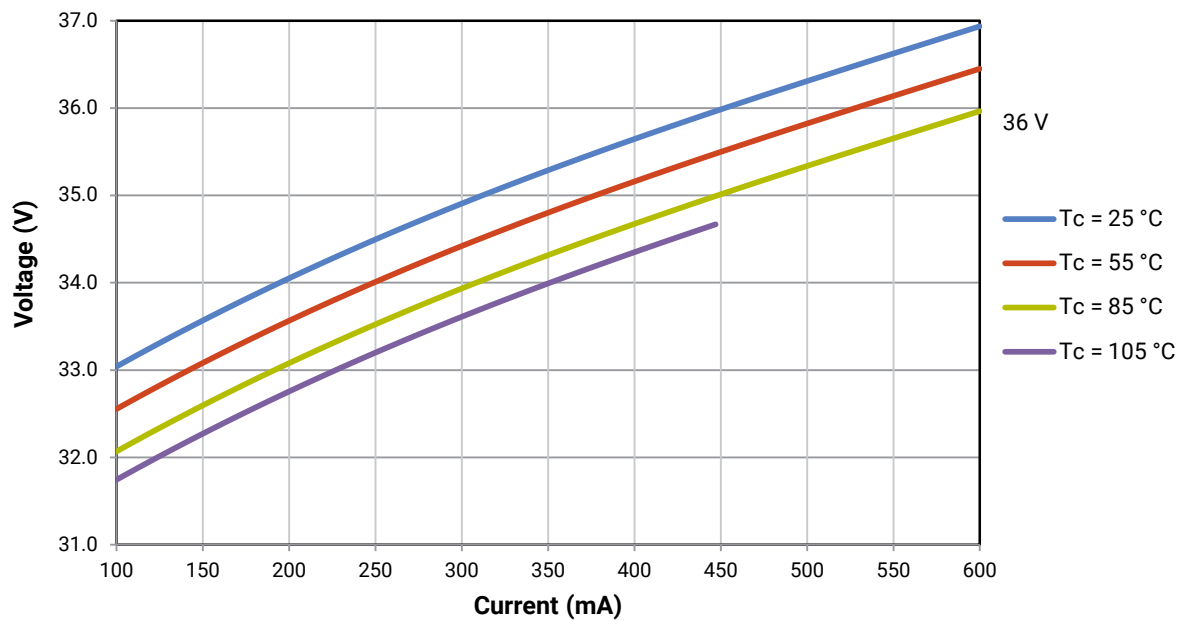
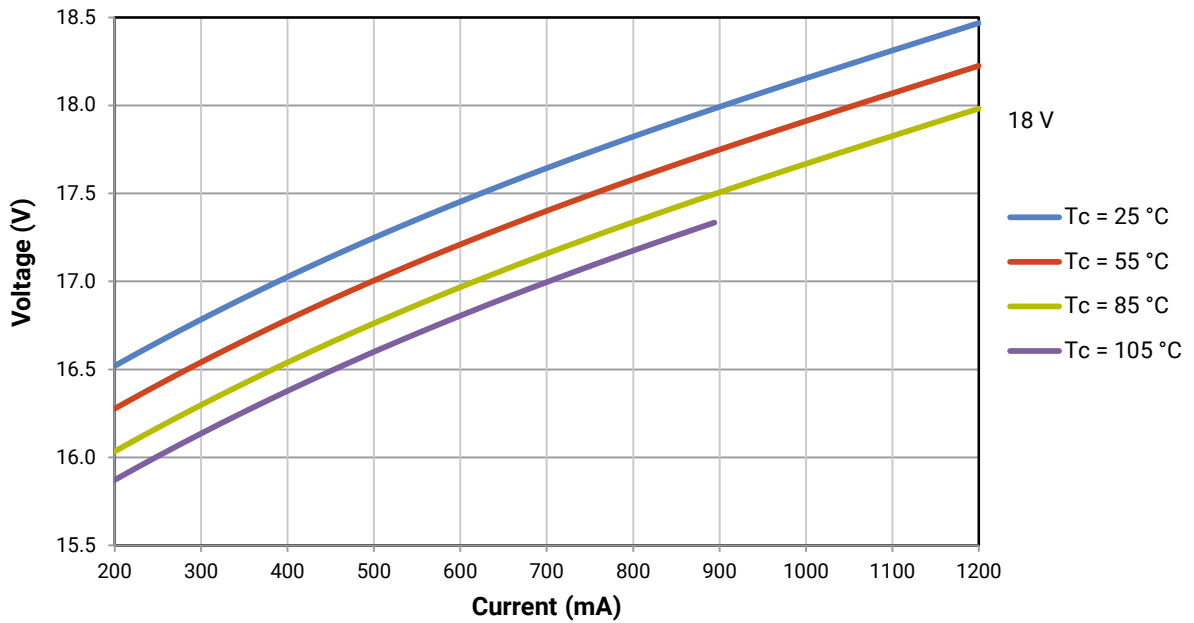

RELATIVE LUMINOUS FLUX

The relative luminous flux values provided below are the ratio of:

- Measurements of CXB1512 at steady-state operation at the given conditions, divided by
- Flux measured during binning, which is a pulsed measurement at 700 mA at $T_j = 85\text{ }^\circ\text{C}$ for the 18-V CXB1512 LED.

Using the 18-V CXB1512 LED as an example, at steady-state operation of $T_c = 25\text{ }^\circ\text{C}$, $I_f = 800\text{ mA}$, the relative luminous flux ratio is 120% in the chart below. A CXB1512 LED that measures 1290 lm during binning will deliver 1548 lm (1290×1.2) at steady-state operation of $T_c = 25\text{ }^\circ\text{C}$, $I_f = 800\text{ mA}$.

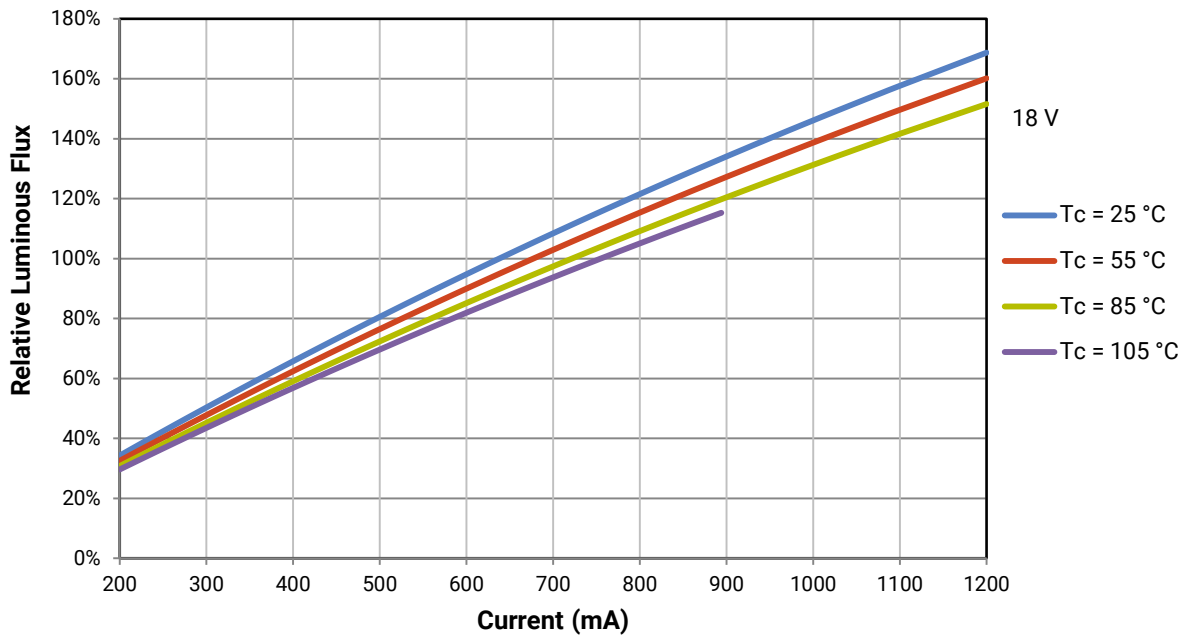

RELATIVE LUMINOUS FLUX - CONTINUED

The relative luminous flux values provided below are the ratio of:

- Measurements of CXB1512 at steady-state operation at the given conditions, divided by
- Flux measured during binning, which is a pulsed measurement at 350 mA at $T_j = 85\text{ }^\circ\text{C}$ for the 36-V CXB1512 LED.

Using the 36-V CXB1512 LED as an example, at steady-state operation of $T_c = 25\text{ }^\circ\text{C}$, $I_f = 400\text{ mA}$, the relative luminous flux ratio is 120% in the chart below. A CXB1512 LED that measures 1290 lm during binning will deliver 1548 lm (1290×1.2) at steady-state operation of $T_c = 25\text{ }^\circ\text{C}$, $I_f = 400\text{ mA}$.

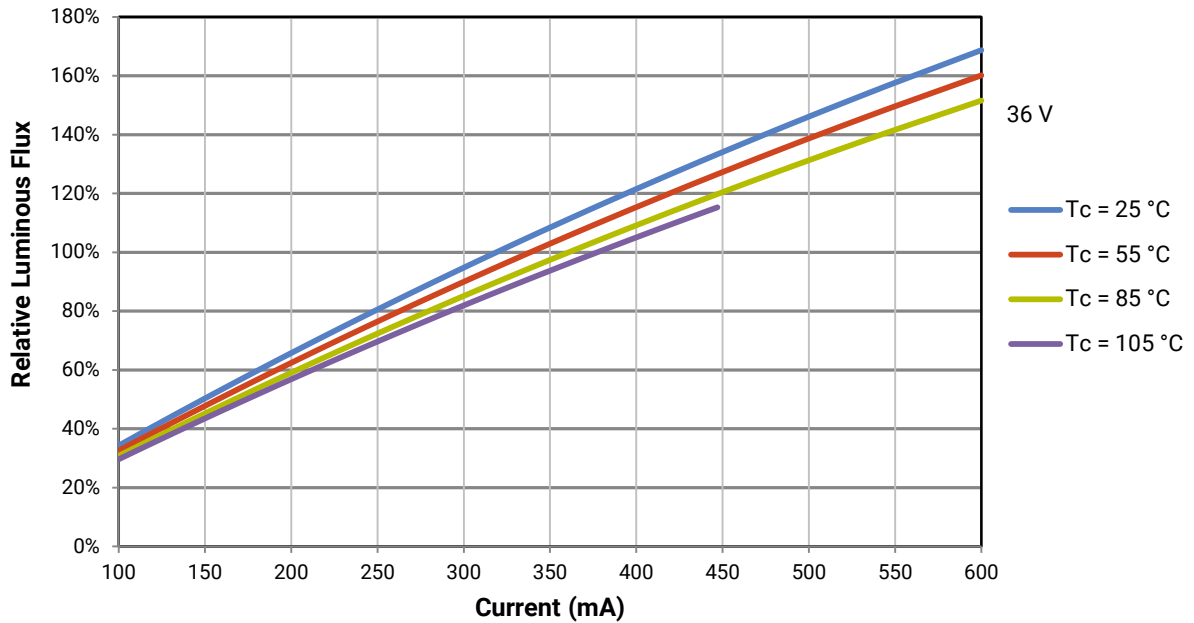

TYPICAL SPATIAL DISTRIBUTION

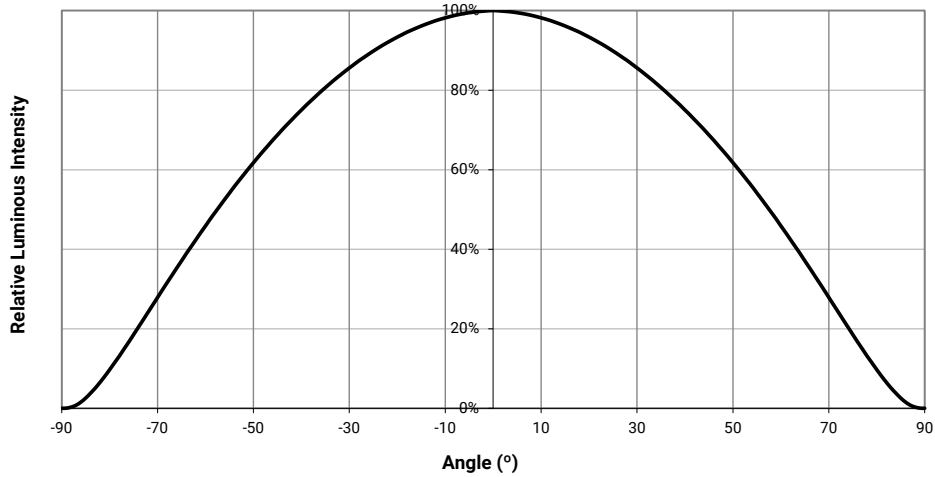

PERFORMANCE GROUPS - BRIGHTNESS (18 V, I_F = 700 mA; 36 V, I_F = 350 mA, T_J = 85 °C)

XLamp CXB1512 LEDs are tested for luminous flux and placed into one of the following bins.

Group Code	Minimum Luminous Flux	Maximum Luminous Flux
J4	1120	1200
K2	1200	1290
K4	1290	1380
M2	1380	1485
M4	1485	1590
N2	1590	1710
N4	1710	1830
P2	1830	1965
P4	1965	2100

PERFORMANCE GROUPS - CHROMATICITY ($T_j = 85\text{ }^\circ\text{C}$)

XLamp CXB1512 LEDs are tested for chromaticity and placed into one of the regions defined by the following bounding coordinates.

EasyWhite Color Temperatures – 2-Step			
Code	CCT	x	y
40H	4000 K	0.3777	0.3739
		0.3797	0.3816
		0.3861	0.3855
		0.3838	0.3777
35H	3500 K	0.4022	0.3858
		0.4053	0.3942
		0.4125	0.3977
		0.4091	0.3891
30H	3000 K	0.4287	0.3975
		0.4328	0.4064
		0.4390	0.4086
		0.4347	0.3996
27H	2700 K	0.4524	0.4048
		0.4574	0.4140
		0.4633	0.4154
		0.4581	0.4062

EasyWhite Color Temperatures – 3-Step Ellipse						
Bin Code	CCT	Center Point		Major Axis	Minor Axis	Rotation Angle (°)
		x	y	a	b	
50G	5000 K	0.3447	0.3553	0.00840	0.00312	65.0
40G	4000 K	0.3818	0.3797	0.00939	0.00402	53.7
35G	3500 K	0.4073	0.3917	0.00927	0.00414	54.0
30G	3000 K	0.4338	0.4030	0.00834	0.00408	53.2
30Q	3000 K	0.4305	0.3935	0.00834	0.00408	53.2
30U	3000 K	0.4274	0.3837	0.00834	0.00408	53.2
27G	2700 K	0.4577	0.4099	0.00834	0.00420	48.5

EasyWhite Color Temperatures – 5-Step Ellipse						
Bin Code	CCT	Center Point		Major Axis	Minor Axis	Rotation Angle (°)
		x	y	a	b	
65E	6500 K	0.3123	0.3282	0.01110	0.00550	61.0
57E	5700 K	0.3287	0.3417	0.01230	0.00600	72.0
50E	5000 K	0.3447	0.3553	0.01400	0.00520	65.0
40E	4000 K	0.3818	0.3797	0.01565	0.00670	53.7

CREE EASYWHITE® BINS PLOTTED ON THE 1931 CIE COLOR SPACE ($T_j = 85^\circ\text{C}$)

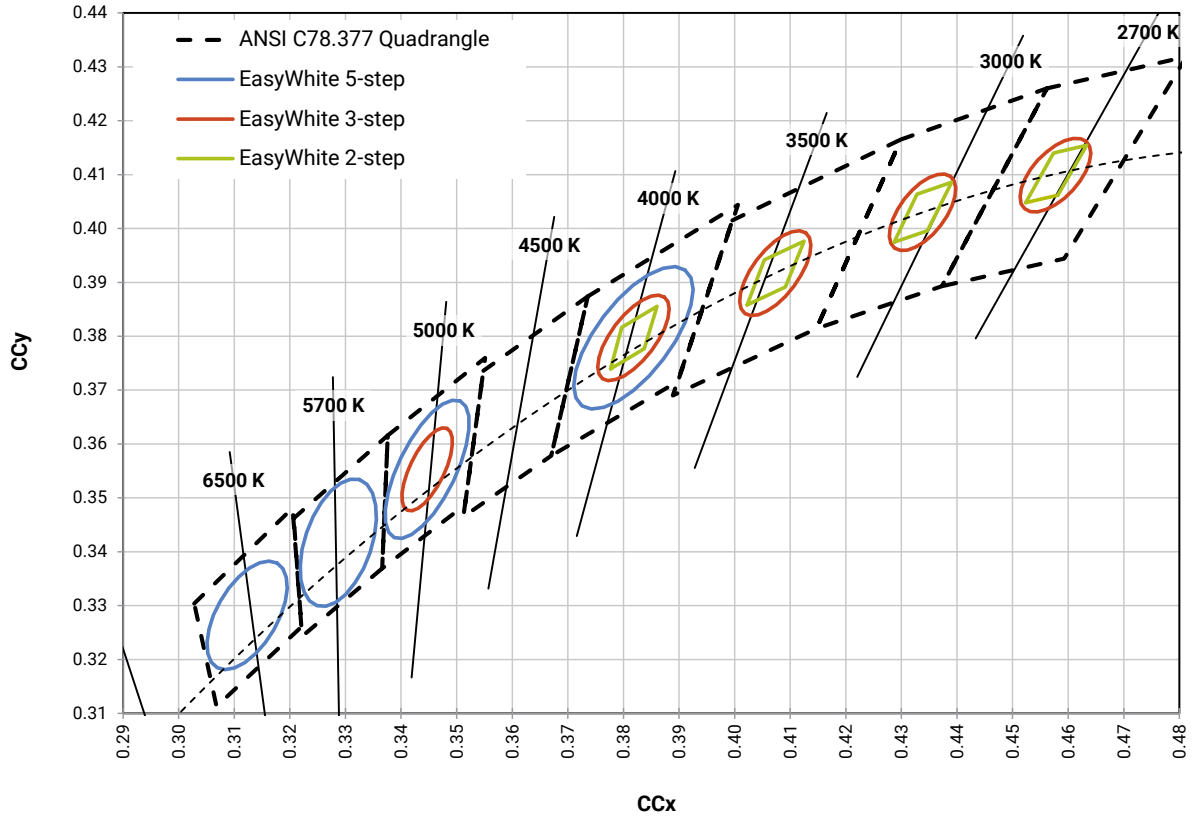

CREE EASYWHITE® BINS PLOTTED ON THE 1931 CIE COLOR SPACE ($T_j = 85^\circ\text{C}$) - CONTINUED

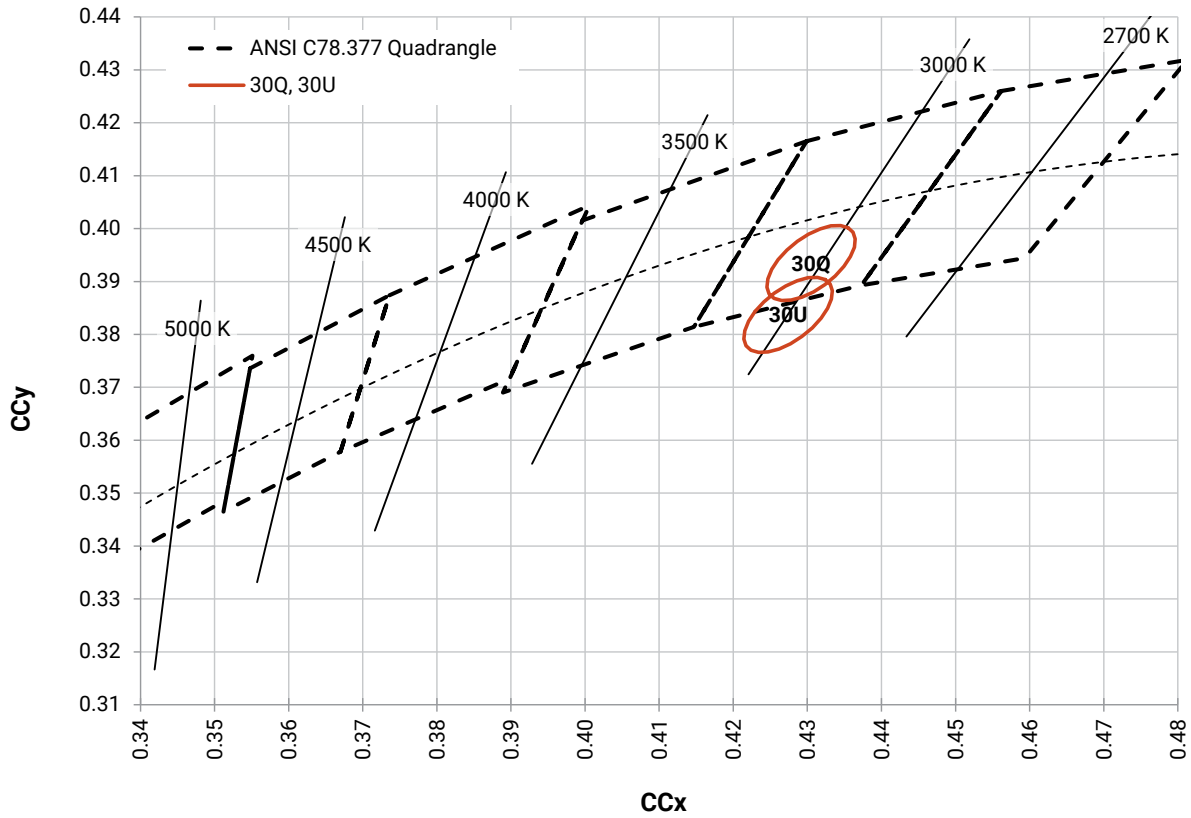

BIN AND ORDER CODE FORMATS

Bin codes and order codes are configured as follows:

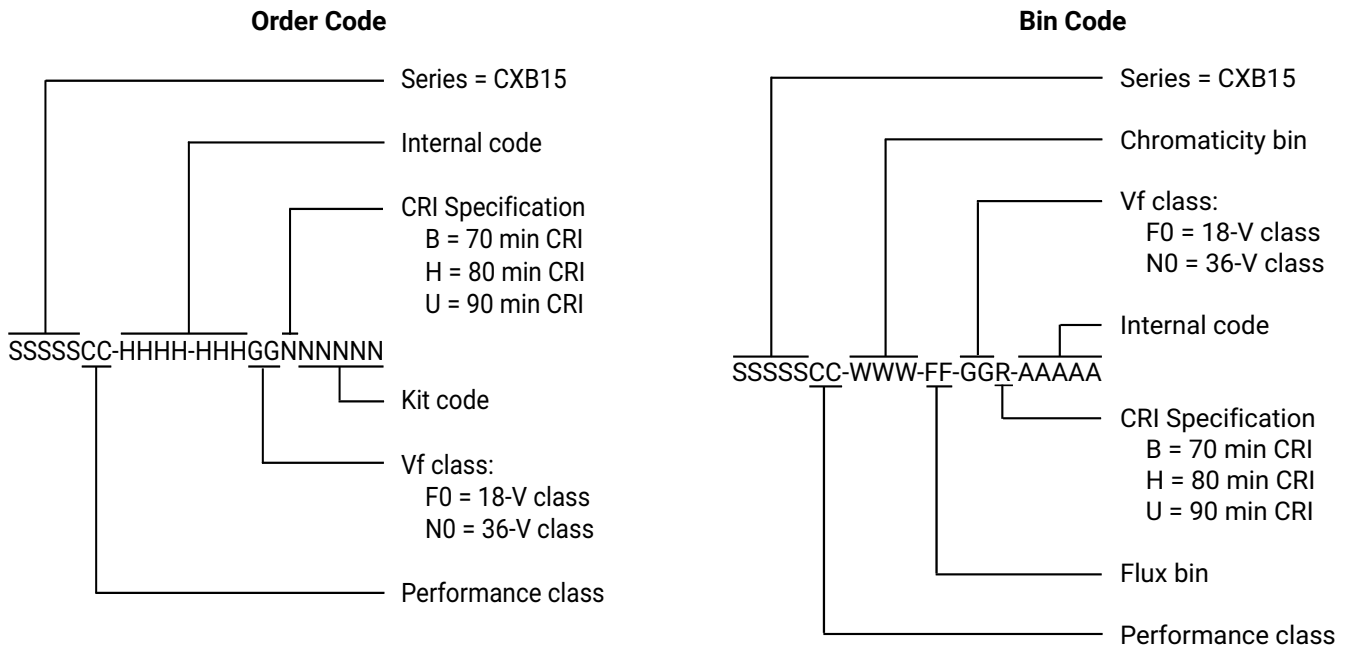

MECHANICAL DIMENSIONS

Dimensions are in mm.
 Tolerances unless otherwise specified: $\pm .13$
 $x^\circ \pm 1^\circ$

Meaning of B1512X
 B1512F = 18-V CXB1512
 B1512N = 36-V CXB1512

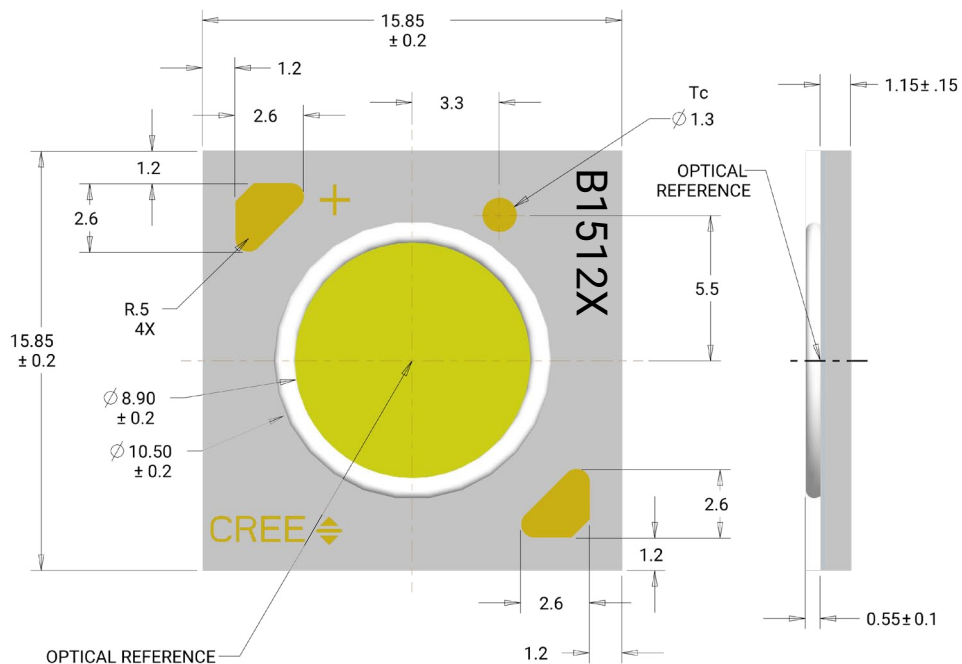

THERMAL DESIGN

The CXB family of LED arrays can include over a hundred different LED die inside one package, and thus over a hundred different junction temperatures (T_j). Cree has intentionally removed junction-temperature-based operating limits and replaced the commonplace maximum T_j calculations with maximum ratings based on forward current (I_f) and case temperature (T_c). No additional calculations are required to ensure the CXB LED is being operated within its designed limits. Please refer to page 3 for the Operating Limit specification.

There is no need to calculate for T_j inside the package, as the thermal management design process, specifically from solder point (T_{sp}) to ambient (T_a), remains identical to any other LED component. For more information on thermal management of Cree XLamp LEDs, please refer to the [Thermal Management application note](#). For CXB soldering recommendations and more information on thermal interface materials (TIM) and connection methods, please refer to the [Cree XLamp CX Family LEDs soldering and handling document](#). The [CX Family LED Design Guide](#) provides basic information on the requirements to use Cree XLamp CXB LEDs successfully in luminaire designs.

To keep the CXB1512 LED at or below the maximum rated T_c , the case to ambient temperature thermal resistance (R_{c-a}) must be at or below the maximum R_{c-a} value shown on the following graphs, depending on the operating environment. The y-axis in the graphs is a base 10 logarithmic scale.

As the figure at right shows, the R_{c-a} value is the sum of the thermal resistance of the TIM (R_{tim}) plus the thermal resistance of the heat sink (R_{hs}).

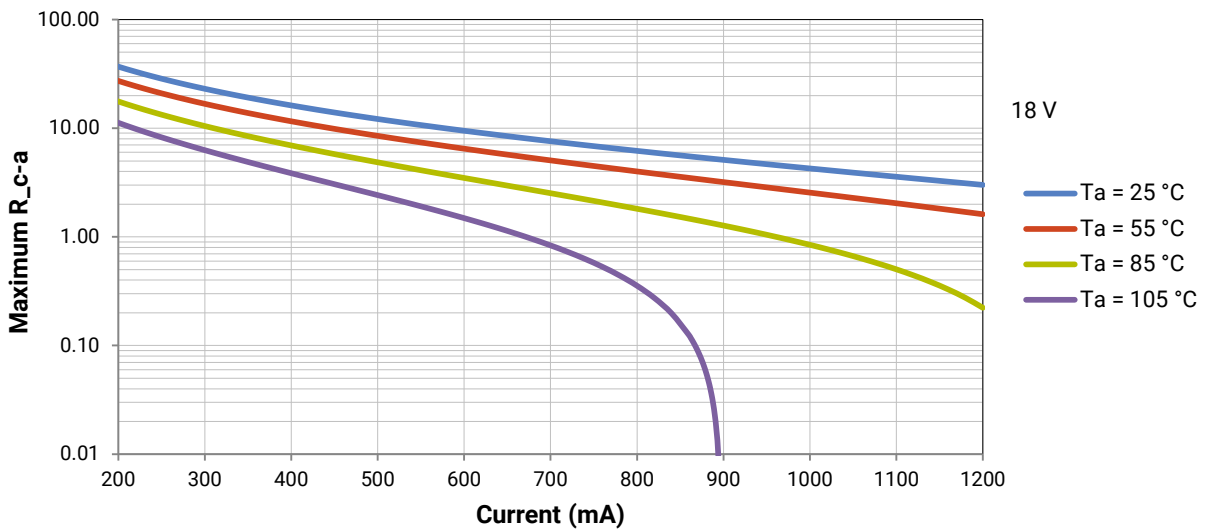
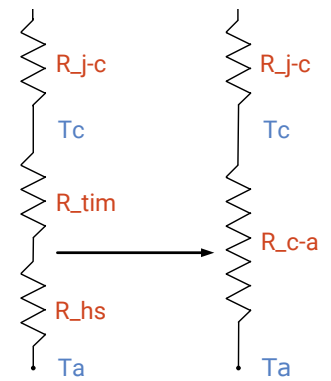

THERMAL DESIGN - CONTINUED

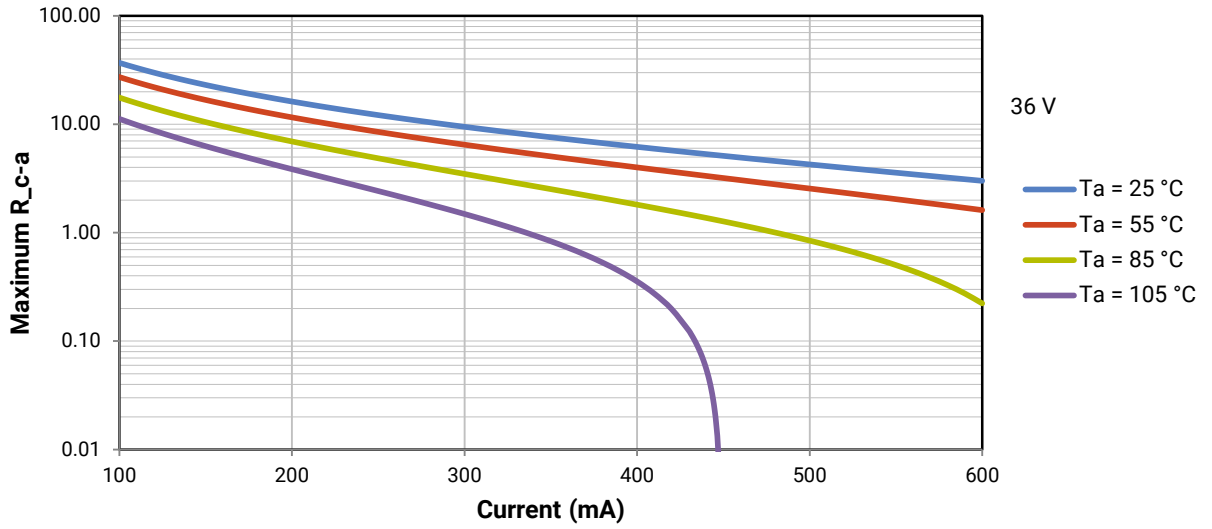

NOTES

Measurements

The luminous flux, radiant power, chromaticity and CRI measurements in this document are binning specifications only and solely represent product measurements as of the date of shipment. These measurements will change over time based on a number of factors that are not within Cree's control and are not intended or provided as operational specifications for the products. Calculated values are provided for informational purposes only and are not intended as specifications.

Pre-Release Qualification Testing

Please read the [LED Reliability Overview](#) for details of the qualification process Cree applies to ensure long-term reliability for XLamp LEDs and details of Cree's pre-release qualification testing for XLamp LEDs.

Lumen Maintenance

Cree now uses standardized IES LM-80-08 and TM-21-11 methods for collecting long-term data and extrapolating LED lumen maintenance. For information on the specific LM-80 data sets available for this LED, refer to the public [LM-80 results document](#).

Please read the [Long-Term Lumen Maintenance application note](#) for more details on Cree's lumen maintenance testing and forecasting. Please read the [Thermal Management application note](#) for details on how thermal design, ambient temperature, and drive current affect the LED junction temperature.

RoHS Compliance

The levels of RoHS restricted materials in this product are below the maximum concentration values (also referred to as the threshold limits) permitted for such substances, or are used in an exempted application, in accordance with EU Directive 2011/65/EC (RoHS2), as implemented January 2, 2013. RoHS Declarations for this product can be obtained from your Cree representative or from the Product Documentation sections of www.cree.com.

REACH Compliance

REACH substances of very high concern (SVHCs) information is available for this product. Since the European Chemical Agency (ECHA) has published notice of their intent to frequently revise the SVHC listing for the foreseeable future, please contact a Cree representative to insure you get the most up-to-date REACH Declaration. REACH banned substance information (REACH Article 67) is also available upon request.

UL® Recognized Component

Level 4 enclosure consideration. The LED package or a portion thereof has been investigated as a fire and electrical enclosure per ANSI/UL 8750.

Vision Advisory

WARNING: Do not look at an exposed lamp in operation. Eye injury can result. For more information about LEDs and eye safety, please refer to the [LED Eye Safety application note](#).

PACKAGING

Cree CXB1512 LEDs are packaged in trays of 20. Five trays are sealed in an anti-static bag and placed inside a carton, for a total of 100 LEDs per carton. Each carton contains 100 LEDs from the same performance bin.

Dimensions are in inches.
Tolerances: $\pm .13$
 $x^\circ \pm 1^\circ$

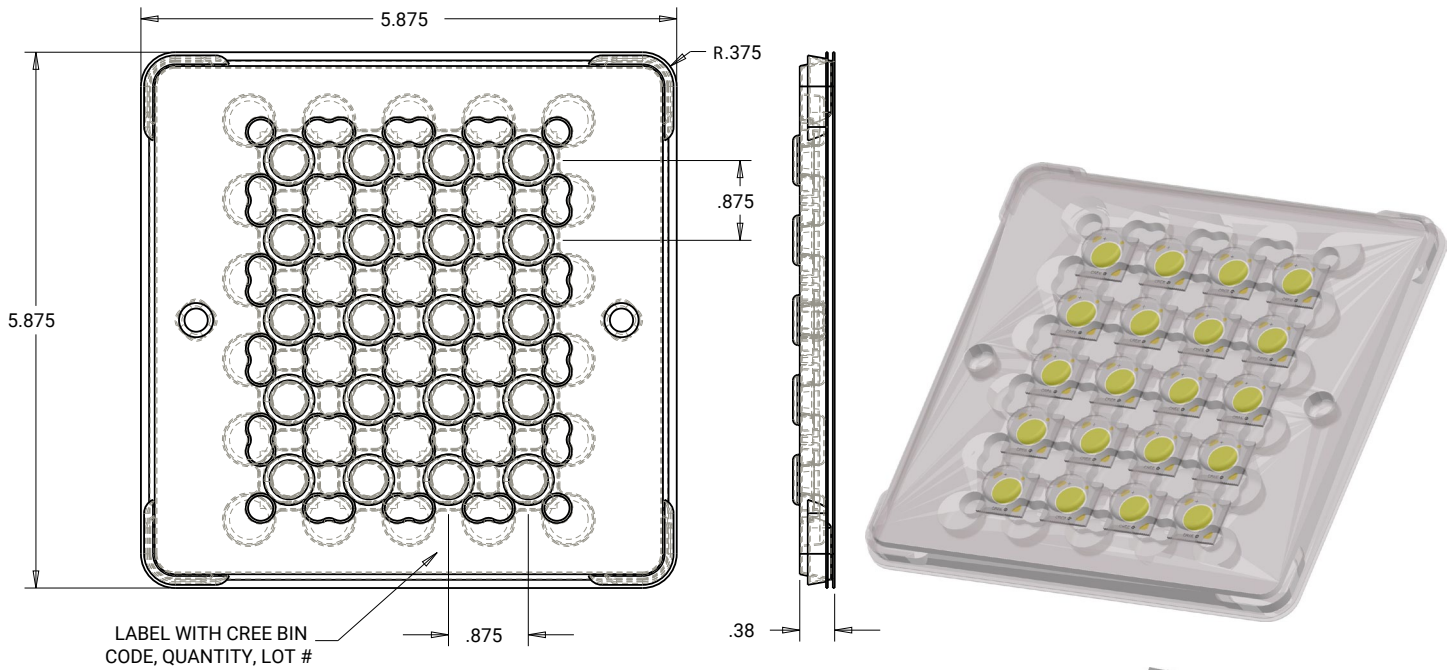

LABEL WITH CREE BIN CODE, QUANTITY, LOT #

PATENT LABEL IS LOCATED ON UNDERSIDE OF CARTON

LABEL WITH CREE BIN CODE, QUANTITY, LOT #

BAG

LABEL WITH CREE BIN CODE, QUANTITY, LOT #