



---

**Configurable PMIC, Five-Channel Buck Regulator plus One-Boost with HyperLight Load<sup>®</sup>, I<sup>2</sup>C Control, and Enable**

---

---

**General Description**

The MIC7401 is a powerful, highly-integrated, configurable, power-management IC (PMIC) featuring five synchronous buck regulators, one boost regulator, and high-speed I<sup>2</sup>C interface with an internal EEPROM.

The device offers two distinct modes of operation “stand-by mode” and “normal mode” intended to provide an energy optimized solution suitable for portable handheld, and infotainment applications.

In normal mode, the programmable switching converters can be configured to support a variety of features, including start-up sequencing, timing, soft-start ramp, output voltage levels, current-limit levels, and output discharge for each channel.

In stand-by mode the PMIC can be configured in a low power state by either disabling an output or by changing the output voltage to a lower level. Independent exit from stand-by mode can be achieved either by I<sup>2</sup>C communication or the external STBY pin.

The device has five synchronous buck regulators with high-speed adaptive on-time control supporting even the challenging ultra-fast transient requirement for core supplies. The one boost regulator provides a flash-memory programming supply that delivers up to 200mA of output current. The boost is equipped with an output disconnect switch that opens if a short-to-ground fault is detected.

An internal EEPROM enables a single-chip solution across many platforms by allowing the designer to customize the PMIC for their design. Modifications can be made without the need to re-approve a new PMIC, saving valuable design resources and time.

All switchers provide light-load efficiency with HyperLight Load<sup>®</sup> mode for buck and PFM mode for boost. An additional benefit of this proprietary architecture is very-low output ripple voltage throughout the entire load range with the use of small output capacitors. The MIC7401 is designed for use with a small inductors (down to 0.47μH for buck, 1.5μH for boost), and an output capacitor as small as 10μF for buck, enabling a total solution size of 12mm × 8.5mm and less than 1mm height on top layer.

The datasheet and other support documentation can be found on Micrel's web site at: [www.micrel.com](http://www.micrel.com).

**Features**

- Input voltage: 2.4V to 5.5V
- Five independent synchronous bucks up to 3A
- One independent non-synchronous boost 200mA
- **200μA quiescent current (all regulators on)**
- **5μA typical shutdown current**
- 93% peak buck efficiency, 85% typical efficiency at 1mA
- **Dual power mode: stand-by and normal mode**
- I<sup>2</sup>C interface up to 3.4MHz
- **I<sup>2</sup>C on-the-fly EEPROM programmability, featuring:**
  - Buck and boost output voltage scaling
  - Power-on-Reset (PoR) threshold and delay
  - Power-up sequencing/sequencing delay
  - Buck and boost current limit
  - Buck and boost pull-down when disabled
  - Individual ON, OFF, and standby modes
  - Soft-start and global power-good masking
- 23μA buck typical quiescent current
- 70μA boost typical quiescent current
- 1.5% output accuracy over temperature/line/load
- 2.0MHz boost switching frequency
- 1.3MHz buck operation in continuous mode
- Ultra-fast buck transient response
- **12mm × 8.5mm × 1.25mm solution size (top layer)**
- Thermal-shutdown and current-limit protection
- 36-pin 4.5mm × 4.5mm × 0.85mm FQFN package (0.4mm pitch)
- –40°C to +125°C junction temperature range

**Applications**

- Client and enterprise solid state drives (SSD)
- Consumer and in-vehicle infotainment devices
- Multimedia devices
- Portable handheld devices
- Security camera
- Gaming machines
- Service provider gateways

---

HyperLight Load is a registered trademark of Micrel, Inc.

Micrel Inc. • 2180 Fortune Drive • San Jose, CA 95131 • USA • tel +1 (408) 944-0800 • fax + 1 (408) 474-1000 • <http://www.micrel.com>

---

## Typical Application

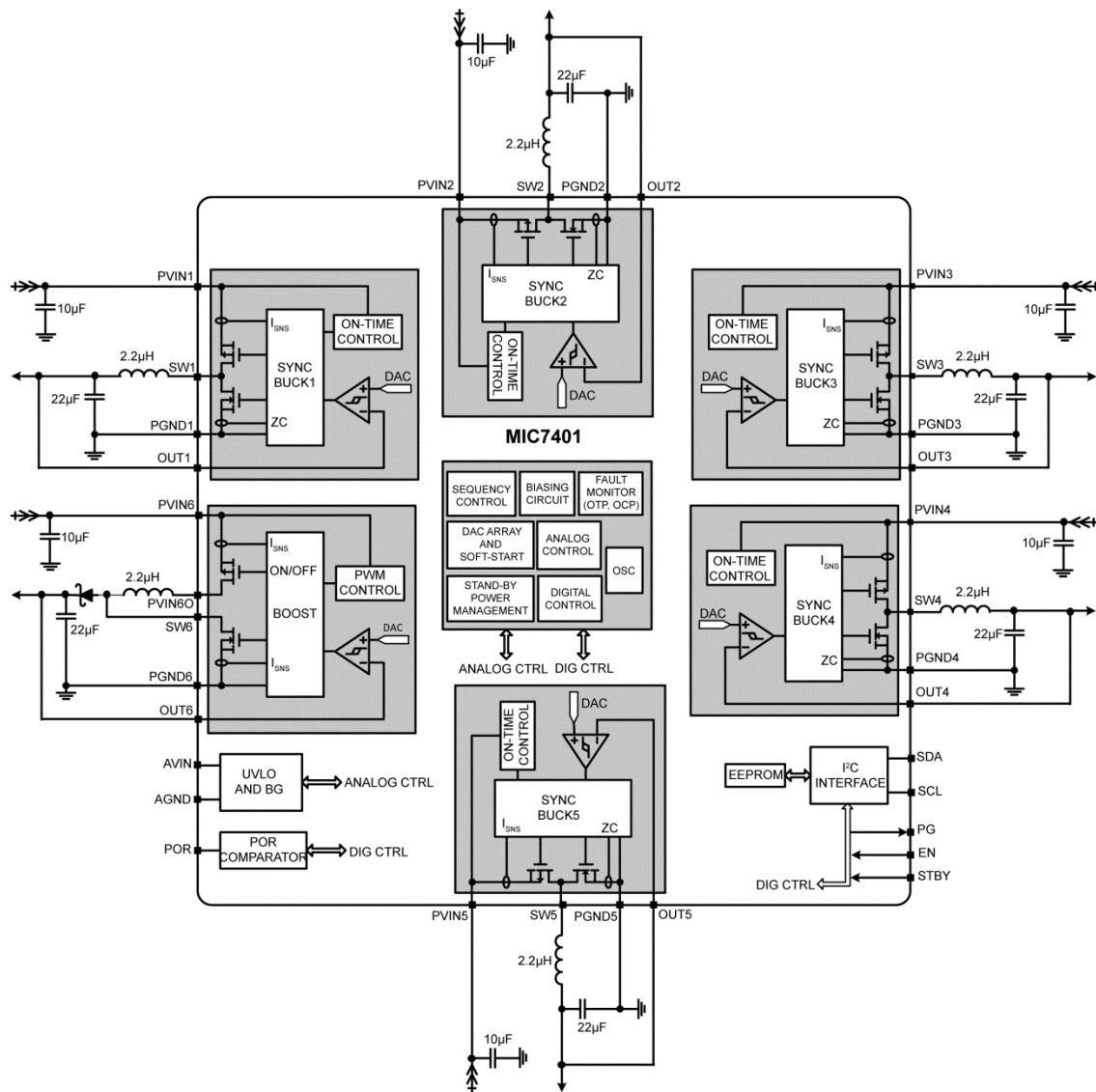

## Ordering Information

Part Number	Marking	Output Voltages	Features	Package <sup>(1)</sup>	Lead Finish
MIC7401YFL	7401 YWWS	1.8V, 1.1V, 1.8V 1.05V, 1.25V, 12V	STBY – Active Low Falling Edge (DEFAULT)	36-Pin 4.5mm x 4.5mm QFN	Pb-Free
MIC7401-XXXXYFL <sup>(2)</sup>	X X 7401 X YYWW X	Configurable	Configurable	36-Pin 4.5mm x 4.5mm QFN	Pb-Free

### Notes:

1. GREEN, RoHS-compliant package. Lead finish is Matte Tin. Mold compound is Halogen Free.
2. Configurable options available upon request. Contact Marketing.

## Table of Contents

General Description .....	1
Features .....	1
Applications .....	1
Typical Application .....	2
Ordering Information .....	2
Table of Contents .....	3
List of Figures .....	5
List of Tables .....	6
Pin Configuration .....	6
Pin Description .....	7
Absolute Maximum Ratings .....	10
Operating Ratings .....	10
Electrical Characteristics .....	10
Typical Characteristics .....	15
Functional Characteristics .....	17
MIC7401 Block Diagram .....	24
Functional Description .....	25
Programmable Buck Soft-Start Control .....	25
Buck Digital Voltage Control (DVC) .....	26
Programmable Boost Soft-Start Control .....	27
Boost Digital Voltage Control (DVC) .....	28
Buck Current Limit .....	28
Boost Current Limit .....	29
Global Power Good Pin .....	29
Standard Delay .....	29
Power-Up Sequencing .....	29
Programmable Power-on-Reset (POR) Delay .....	30
Power-Down Sequencing .....	30
Stand-By Mode .....	31
Resistive Discharge .....	31
STBY Pin .....	31
Safe Start-Up into a Pre-Biased Output .....	32
Buck Regulator Power Dissipation .....	32
Total Power Dissipation .....	32
Power Derating .....	33
Overtemperature Fault .....	33
Input Voltage "Hot-Plug" .....	34
Thermal Measurements .....	34

## Table of Contents (Continued)

Timing Diagrams .....	35
Normal Power-Up Sequence for Outputs .....	35
Standby (STBY) Pin (Wake-Up).....	36
Evaluation Board Schematic.....	37
Bill of Materials .....	38
PCB Layout Guidelines .....	39
General .....	39
IC .....	39
Input Capacitor .....	39
Inductor .....	39
Output Capacitor .....	39
Proper Termination of Unused Pins .....	40
PCB Layout Recommendations .....	41
Package Information <sup>(17)</sup> and Recommended Landing Pattern .....	45
Via Layout Design and Layout Constraints .....	46
Appendix A .....	47
I <sup>2</sup> C Control Register .....	47
Serial Port Operation .....	47
External Host Interface .....	47
Special Host I <sup>2</sup> C Commands .....	48
Special Keys .....	48
Appendix B .....	49
Register Settings Descriptions .....	49
Power Good Register (00'h) .....	49
EEPROM-Ready Register (01'h) .....	50
Fault Registers (02'h).....	51
Standby Register (03'h).....	52
Enable/Disable Register (04'h).....	53
Regulator Output Voltage Setting NORMAL Mode (05'h – 09'h) .....	54
Boost Regulator Output Voltage Setting NORMAL Mode (0A'h) .....	55
Regulator Voltage Setting STBY Mode (0B'h – 0F'h) .....	56
Boost Regulator Output Voltage Setting STBY Mode (10'h).....	57
Sequence Register (11'h).....	58
Delay Register (17'h).....	61
Soft-Start Registers (18'h – 1A'h).....	62
Current-Limit (Normal Mode) Registers (1B'h – 1D'h) .....	63
Current-Limit (STBY Mode) Registers (1E – 20'h).....	65
Power-on-Reset (POR) Threshold Voltage Setting Register (21'h and 22'h).....	66
Pull-Down when Disabled Register (23'h).....	67

## List of Figures

Figure 1. Buck Soft-Start.....	25
Figure 2. Buck Soft-Start.....	26
Figure 3. Buck DVC Control Ramp.....	26
Figure 4. Buck DVC Control Ramp.....	27
Figure 5. Boost Soft-Start Ramp.....	27
Figure 6. Boost Soft-Start.....	27
Figure 7. Boost DVC Control Ramp.....	28
Figure 8. Standard Delay Time.....	29
Figure 9. Hot Plug – $V_{IN}$ Rising.....	30
Figure 10. POR.....	30
Figure 11. Hot Un-Plug – $V_{IN}$ Falling.....	30
Figure 12. I <sup>2</sup> C Stand-By Mode.....	31
Figure 13. Output Pull-Down Resistance.....	31
Figure 14. STBY-to-NORMAL Transition (DEFAULT).....	32
Figure 15. Pre-Biased Output Voltage.....	32
Figure 16. Power Dissipation.....	33
Figure 17. Power Derating Curve.....	33
Figure 18. Hot-Plug Input Voltage Spike.....	34
Figure 19. MIC7401 Power-Up/-Down.....	35
Figure 20. MIC7401 STBY Function (DEFAULT).....	36
Figure 21. Connections for Unused Pins.....	40
Figure 22. Read/Write Protocol.....	47

## List of Tables

Table 1. Buck Outputs Default Soft-Start Time (DEFAULT) .....	26
Table 2. Boost Output Default Soft-Start Time .....	28
Table 3. Buck Current Limit Register Settings .....	28
Table 4. Summarization of Unused Pin Connections .....	40
Table 5. Power Good Status Register .....	49
Table 6. EEPROM Status Register .....	50
Table 7. Overcurrent Status Fault Register .....	51
Table 8. Standby Register .....	52
Table 9. Enable Register .....	53
Table 10. DVC Registers for OUT[1 – 5] .....	54
Table 11. DVC Registers for OUT6 .....	55
Table 12. Standby Registers .....	56
Table 13. Standby DVC Register for OUT6 .....	57
Table 14. Sequence State 1 Register .....	58
Table 15. Sequence State 2 Register .....	59
Table 16. Sequence State 3 Register .....	59
Table 17. Sequence State 4 Register .....	60
Table 18. Sequence State 5 Register .....	60
Table 19. Sequence State 6 Register .....	61
Table 20. Delay Register .....	61
Table 21. Soft-Start Register Speed Settings .....	62
Table 22. Soft-Start Register OUT1 and OUT2 .....	62
Table 23. Soft-Start Register OUT3 and OUT4 .....	62
Table 24. Soft-Start Register OUT5 and OUT6 .....	63
Table 25. Current-Limit Register $I_{OUT1}$ and $I_{OUT2}$ .....	63
Table 26. Current-Limit Register $I_{OUT3}$ and $I_{OUT4}$ .....	64
Table 27. Current-Limit Register $I_{OUT5}$ and $I_{OUT6}$ .....	64
Table 28. Standby Current-Limit Register $I_{OUT1}$ and $I_{OUT2}$ .....	65
Table 29. Standby Current-Limit Register $I_{OUT3}$ and $I_{OUT4}$ .....	65
Table 30. Standby Current-Limit Register $I_{OUT5}$ and $I_{OUT6}$ .....	66
Table 31. Rising and Falling Power-on-Reset Threshold Voltage Settings .....	66
Table 32. Power-on-Reset Rising Threshold Voltage Setting Register (21'h) .....	66
Table 33. Power-on-Reset Falling Threshold Voltage Setting Register (22'h) .....	67
Table 34. Pull-Down when Disabled Register .....	67

## Pin Configuration

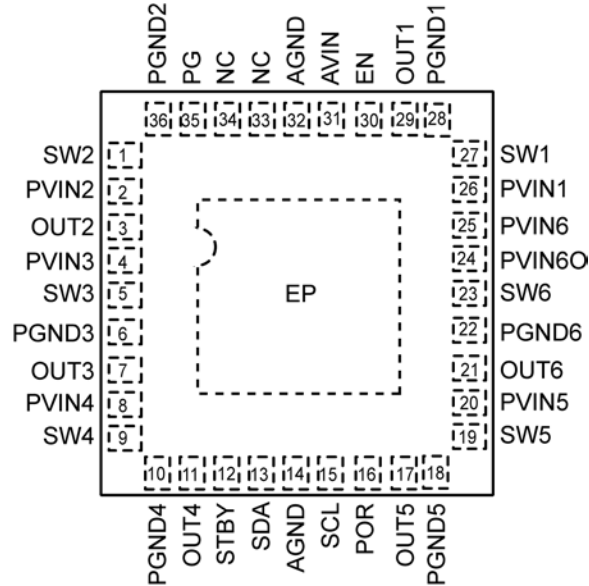

**36-Pin 4.5mm x 4.5mm FQFN (FL)  
(Top View)**

## Pin Description

Pin Number	Pin Name	Description
1	SW2	Switch Pin 2 (Output): Inductor connection for the synchronous step-down regulator. Connect the inductor between the output capacitor and the SW2 pin.
2	PVIN2	Power Supply Voltage 2 (Input): Input supply to the source of the internal high-side P-channel MOSFET. An input capacitor between PVIN2 and the power ground PGND2 pin is required and to be placed as close as possible to the IC.
3	OUT2	Output Voltage Sense 2 (Input): This pin is used to sense the output voltage. Connect OUT2 as close to the output capacitor as possible to sense output voltage. Also provides the path to discharge the output through an internal 90Ω resistor when disabled. This pull-down feature is programmed through the PULLD[x] register.
4	PVIN3	Power Supply Voltage 3 (Input): Input supply to the source of the internal high-side P-channel MOSFET. An input capacitor between PVIN3 and the power ground PGND3 pin is required and to be placed as close as possible to the IC.
5	SW3	Switch Pin 3 (Output): Inductor connection for the synchronous step-down regulator. Connect the inductor between the output capacitor and the SW3 pin.
6	PGND3	Power Ground 3: The power ground for the synchronous buck converter power stage. The PGND pin connects to the sources of the internal low-side N-Channel MOSFET, the negative terminals of input capacitors, and the negative terminals of output capacitors.
7	OUT3	Output Voltage Sense 3 (Input): This pin is used to sense the output voltage. Connect OUT3 as close to the output capacitor as possible to sense output voltage. Also provides the path to discharge the output through an internal 90Ω resistor when disabled. This pull-down feature is programmed through the PULLD[x] register.
8	PVIN4	Power Supply Voltage 4 (Input): Input supply to the source of the internal high-side P-channel MOSFET. An input capacitor between PVIN4 and the power ground PGND4 pin is required and to be placed as close as possible to the IC.

**Pin Description (Continued)**

Pin Number	Pin Name	Description
9	SW4	Switch Pin 4 (Output): Inductor connection for the synchronous step-down regulator. Connect the inductor between the output capacitor and the SW4 pin.
10	PGND4	Power Ground 4: The power ground for the synchronous buck converter power stage. The PGND pin connects to the source of the internal low-side N-Channel MOSFET, the negative terminals of input capacitors, and the negative terminals of output capacitors.
11	OUT4	Output Voltage Sense 4 (Input): This pin is used to sense the output voltage. Connect the OUT4 as close to the output capacitor as possible to sense output voltage. Also provides the path to discharge the output through an internal 90Ω resistor when disabled. This pull-down feature is programmed through the PULLD[x] register.
12	STBY	Standby Reset (Input): Standby mode allows the total power consumption to be reduced by either lowering a supply voltage or turning it off. The IC can be placed in standby mode while operating in normal mode by a high-to-low transition (DEFAULT) on the STBY input. When this occurs, the STBY_MODEB bit will be set to logic "0". Either a low-to-high transition on the STBY pin or an I <sup>2</sup> C write command to the STBY_MODEB bit sets all of the regulators to their normal mode default settings. This pin can be driven with either a digital signal or open collector output. Do not let this pin float. Connect to ground or V <sub>IN</sub> . A pull-down resistor of 100kΩ or less can also be used. There are both a high-to-low (DEFAULT) and low-to-high normal to standby trigger options available.
13	SDA	High-Speed Mode 3.4MHz I <sup>2</sup> C Data (Input/Output): This is an open drain, bidirectional data pin. Data is read on the rising edge of the SCL and data is clocked out on the falling edge of the SCL. External pull-up resistors are required.
14	AGND	Analog Ground: Internal signal ground for all low power circuits. Connect to ground plane for best operation.
15	SCL	High-Speed Mode 3.4MHz I <sup>2</sup> C Clock (Input): I <sup>2</sup> C serial clock line open drain input. External pull-up resistors are required.
16	POR	Power-on-Reset (Output): This is an open drain output that goes high after the POR delay time elapses. The POR delay time starts as soon as the AVIN pin voltage rises above the upper threshold set by the PORUP register. The POR output goes low without delay when AVIN falls below the lower threshold set by the PORDN register.
17	OUT5	Output Voltage Sense 5 (Input): This pin is used to sense the output voltage. Connect OUT5 as close to the output capacitor as possible to sense output voltage. Also provides the path to discharge the output through an internal 90Ω resistor when disabled. This pull-down feature is programmed through the PULLD[x] register.
18	PGND5	Power Ground 5: The power ground for the synchronous buck converter power stage. The PGND pin connects to the source of the internal low-side N-Channel MOSFET, the negative terminals of input capacitors, and the negative terminals of output capacitors.
19	SW5	Switch Pin 5 (Output): Inductor connection for the synchronous step-down regulator. Connect the inductor between the output capacitor and the SW5 pin.
20	PVIN5	Power Supply Voltage 5 (Input): Input supply to the source of the internal high-side P-channel MOSFET. An input capacitor between PVIN5 and the power ground PGND5 pin is required and to be placed as close as possible to the IC.
21	OUT6	Output Voltage 6 Sense (Input): This pin is used to sense the output voltage. Connect OUT6 as close to the output capacitor as possible to sense output voltage. Also provides the path to discharge the output through an internal programmable current source when disabled. This pull-down feature is programmed through the PULLD[x] register.
22	PGND6	Power Ground 6: The power ground for the boost converter power stage. The PGND pin connects to the source of the internal low-side N-Channel MOSFET, the negative terminals of input capacitors, and the negative terminals of output capacitors.
23	SW6	Switch Pin 6 (Input): Inductor connection for the boost regulator. Connect the inductor between the PVIN6O and SW6 pin.



**Pin Description (Continued)**

Pin Number	Pin Name	Description
24	PVIN6O	Power Supply Voltage 6 (Output): This pin is the output of the power disconnect switch for the boost regulator. When the boost regulator is on, an internal switch provides a current path for the boost inductor. In shutdown, an internal P-channel MOSFET is turned off and disconnects the boost output from the input supply. This feature eliminates current draw from the input supply during shutdown. An input capacitor between PVIN6O and the power ground PGND6 pin is required and place as close as possible to the IC.
25	PVIN6	Power Supply Voltage 6 (Input): Input supply to the internal disconnect switch.
26	PVIN1	Power Supply Voltage 1 (Input): Input supply to the source of the internal high-side P-channel MOSFET. An input capacitor between PVIN1 and the power ground PGND1 pin is required and to be placed as close as possible to the IC.
27	SW1	Switch Pin 1 (Output): Inductor connection for the synchronous step-down regulator. Connect the inductor between the output capacitor and the SW1 pin.
28	PGND1	Power Ground 1: The power ground for the synchronous buck converter power stage. The PGND pin connects to the source of the internal low-side N-Channel MOSFET, the negative terminals of input capacitors, and the negative terminals of output capacitors.
29	OUT1	Output Voltage Sense 1 (Input): This pin is used to sense the output voltage remotely. Connect OUT1 as close to output capacitor as possible to sense output voltage. This feature also provides the path to discharge the output through an internal 90Ω resistor when disabled. The pull-down feature is programmed through the PULLD[x] register.
30	EN	Enable (input): A logic level control of both outputs. The EN pin is CMOS-compatible. Logic high = enable, logic low = shutdown. In the off state, supply current of the device is greatly reduced (typically 1μA). When the EN pin goes high, the start-up sequence is initiated. When EN goes low, all outputs are immediately turned off and the boost output ( $V_{OUT6}$ ) is completely disconnected from the input voltage. The EN pin must be high for the I2C to communicate with the IC; otherwise, the IC cannot be programmed. Do not let this pin float. Connect to ground or $V_{IN}$ . A pull-up resistor of 500kΩ can also be used
31	AVIN	Analog Voltage Supply (Input): The start-up sequence begins as soon as the AVIN pin voltage rises above the IC's UVLO upper threshold. The outputs do not turn off until AVIN pin voltage falls below the lower threshold limit. A 2.2μF ceramic capacitor from the AVIN pin to AGND pin must be placed next to the IC.
32	AGND	Analog Ground: Internal signal ground for all low power circuits. Connect directly to the layer 2 ground plane. Layer 2 is the point where all the PGNDs and AGND are connected. Do not connect PGND and AGND together on the top layer.
33	NC	No Connect. Must be left floating.
34	NC	No Connect. Must be left floating.
35	PG	Global Power Good (Output): This is an open drain output that is pulled high when all the regulator power good flags are high. If an output falls below the power good threshold or a thermal fault occurs, the global power good flag is pulled low. There is a falling edge de-glitch time of 50μs to prevent false triggering on output voltage transients. A power good mask feature programmed through the PGOOD_MASK[x] registers can be used to ignore a power good fault. When masked an individual power good fault will not cause the global power good output to de-assert. Do not connect the power good pull-up resistor to a voltage higher than $V_{IN}$ .
36	PGND2	Power Ground 2: The power ground for the synchronous buck converter power stage. The PGND pin connects to the source of the internal low-side N-Channel MOSFET, the negative terminals of input capacitors, and the negative terminals of output capacitors.
EP	ePad	Exposed Pad: Must be connected to the GND plane for full output power to be realized.

### Absolute Maximum Ratings<sup>(3)</sup>

Supply Voltages (PV <sub>IN[1-6]</sub> )	-0.3V to 6V
Analog Supply Voltage (AV <sub>IN</sub> )	-0.3V to 6V
Buck Output Voltages (V <sub>OUT[1-5]</sub> )	-0.3V to 6V
Boost Output Voltage (V <sub>OUT6</sub> )	-0.3V to 20V
Buck Switch Voltages (V <sub>SW[1-5]</sub> )	-0.3V to 6V
Boost Switch Voltage (V <sub>SW6</sub> )	-0.3V to 20V
Power Good Voltage (V <sub>PG</sub> )	-0.3V to AV <sub>IN</sub>
Power-On Reset Output (V <sub>POR</sub> )	-0.3V to 6V
Enable Voltage (V <sub>EN</sub> )	-0.3V to 6V
Standby Voltage (V <sub>STBY</sub> )	-0.3V to 6V
I <sup>2</sup> C IO (V <sub>SDA</sub> , V <sub>SCL</sub> )	-0.3V to AV <sub>IN</sub>
AGND to PGND[1-6]	-0.3V to 0.3V
Ambient Storage Temperature (T <sub>s</sub> )	-65°C to +150°C
ESD HBM Rating <sup>(6)</sup>	2kV
ESD MM Rating	200V

### Operating Ratings<sup>(4)</sup>

Input Voltage (PV <sub>IN[1-6]</sub> )	2.4V to 5.5V
Analog Input Voltage (AV <sub>IN</sub> )	2.4V to 5.5V
Buck Output Voltage Range (V <sub>OUT[1-5]</sub> )	0.8V to 3.3V
Boost Output Voltage Range (V <sub>OUT6</sub> )	7V to 14V
Power Good Voltage (V <sub>PG</sub> )	0V to AV <sub>IN</sub>
Power-On Reset Output (V <sub>POR</sub> )	0V to AV <sub>IN</sub>
Enable Voltage (V <sub>EN</sub> )	0V to AV <sub>IN</sub>
Standby Voltage (V <sub>STBY</sub> )	0V to AV <sub>IN</sub>
I <sup>2</sup> C IO (V <sub>SDA</sub> , V <sub>SCL</sub> )	0V to AV <sub>IN</sub>
Junction Temperature (T <sub>J</sub> ) <sup>(5)</sup>	-40°C to +125°C
Junction Thermal Resistance	
4.5mm x 4.5mm FQFN-36 (θ <sub>JA</sub> )	30°C/W

### Electrical Characteristics<sup>(7)</sup>

V<sub>IN</sub> = AV<sub>IN</sub> = PV<sub>IN[1-6]</sub> = 5.0V; V<sub>OUT1</sub> = 1.8V; V<sub>OUT2</sub> = 1.1V; V<sub>OUT3</sub> = 1.8V; V<sub>OUT4</sub> = 1.05V; V<sub>OUT5</sub> = 1.25V; V<sub>OUT6</sub> = 12V (refer to the [Evaluation Board Schematic](#) for component values). T<sub>A</sub> = 25°C, unless otherwise noted. **Bold** values indicate -40°C ≤ T<sub>J</sub> ≤ +125°C.

Parameter	Conditions	Min.	Typ.	Max.	Unit
<b>Input Supply (VIN)</b>					
Input Voltage Range (AV <sub>IN</sub> , PV <sub>IN[1-6]</sub> )		<b>2.4</b>		<b>5.5</b>	V
Operating Quiescent Current into AV <sub>IN</sub> <sup>(8, 9)</sup>	V <sub>IN</sub> = 5.0V; I <sub>OUT</sub> = 0A		200	240	μA
Operating Quiescent Current into PV <sub>IN</sub> <sup>(8)</sup>	V <sub>IN</sub> = 5.0V; I <sub>OUT</sub> = 0A		0.3	1	μA
Shutdown Current into (PV <sub>IN</sub> + AV <sub>IN</sub> )	V <sub>IN</sub> = 5.0V; V <sub>EN</sub> = 0V		5		μA
Undervoltage Lockout Threshold	AV <sub>IN</sub> Rising	<b>2.15</b>	2.25	<b>2.35</b>	V
Undervoltage Lockout Hysteresis			150		mV
<b>Standby Input (STBY)</b>					
Logic Level High		<b>1.2</b>			V
Logic Level Low				<b>0.4</b>	V
Bias Current into Pin	V <sub>STBY</sub> = V <sub>IN</sub>			200	nA
Bias Current out of Pin	V <sub>STBY</sub> = 0V			200	nA
Rising/Falling Edge Reset Deglitch			100		μs

**Notes:**

- Absolute maximum ratings indicate limits beyond which damage to the component may occur.
- The device is not guaranteed to function outside its operating rating.
- The maximum allowable power dissipation is a function of the maximum junction temperature, T<sub>J(Max)</sub>, the junction-to-ambient thermal resistance, θ<sub>JA</sub>, and the ambient temperature, T<sub>A</sub>. The maximum allowable power dissipation will result in excessive die temperature, and the regulator will go into thermal shutdown.
- Devices are ESD sensitive. Handling precautions recommended. Human body model, 1.5kΩ in series with 100pF.
- Specification for packaged product only.
- Tested in a non-switching configuration.
- When all outputs are configured to the minimum programmable voltage.

## Electrical Characteristics<sup>(7)</sup> (Continued)

$V_{IN} = AV_{IN} = PV_{IN(1-6)} = 5.0V$ ;  $V_{OUT1} = 1.8V$ ;  $V_{OUT2} = 1.1V$ ;  $V_{OUT3} = 1.8V$ ;  $V_{OUT4} = 1.05V$ ;  $V_{OUT5} = 1.25V$ ;  $V_{OUT6} = 12V$  (refer to the [Evaluation Board Schematic](#) for component values).  $T_A = 25^\circ C$ , unless otherwise noted. **Bold** values indicate  $-40^\circ C \leq T_J \leq +125^\circ C$ .

Parameter	Conditions	Min.	Typ.	Max.	Unit
<b>Enable Input (EN)</b>					
Logic Level High	$V_{EN}$ Rising, Regulator Enabled	<b>1.2</b>			V
Logic Level Low	$V_{EN}$ Falling, Regulator Shutdown			<b>0.4</b>	V
Bias Current Into Pin	$V_{EN} = V_{IN}$			200	nA
Bias Current Out of Pin	$V_{EN} = 0V$			200	nA
<b>Power-On-Reset (POR) Comparator</b>					
POR Upper Comparator Range	$AV_{IN}$ Rising	2.646	2.7	2.754	V
POR Lower Comparator Range	$AV_{IN}$ Falling	2.548	2.6	2.652	V
<b>Power Reset Output (POR) and Timer</b>					
POR Delay		18	20	22	ms
POR Deglitch Delay	$AV_{IN}$ Falling		50		$\mu s$
POR Output Low Voltage	$I_{POR} = 10mA$ (sinking)		75	400	mV
POR Leakage Current	$V_{POR} = 5.5V$			200	nA
<b>Global Power Good Output (PG)</b>					
Buck Power Good Threshold Voltage	$V_{OUT[1-5]}$ Rising	87	91	95	$\%V_{OUT}$
Buck Hysteresis <sup>(10)</sup>	$V_{OUT[1-5]}$ Falling		4		$\%V_{OUT}$
Boost Power Good Threshold Voltage	$V_{OUT[6]}$ Rising	87	91	95	$\%V_{OUT}$
Boost Hysteresis <sup>(10)</sup>	$V_{OUT[6]}$ Falling		380		mV
Power Good Output Low Voltage	$I_{PG} = 10mA$ (sinking)		75	400	mV
Power Good Leakage Current	$V_{PG} = 5.5V$		0.01	200	nA
Power Good De-Glitch Delay	$V_{OUT[1-6]}$ Falling		100		$\mu s$
Output Sequencing Delay <sup>(10)</sup>		0.96	1	1.04	ms
<b>Thermal Protection</b>					
Thermal Shutdown	$T_J$ Rising		160		$^\circ C$
Thermal Hysteresis			20		$^\circ C$

**Note:**

10. Guaranteed by design.

## Electrical Characteristics<sup>(7)</sup> (Continued)

$V_{IN} = AV_{IN} = PV_{IN(1-6)} = 5.0V$ ;  $V_{OUT1} = 1.8V$ ;  $V_{OUT2} = 1.1V$ ;  $V_{OUT3} = 1.8V$ ;  $V_{OUT4} = 1.05V$ ;  $V_{OUT5} = 1.25V$ ;  $V_{OUT6} = 12V$  (refer to the [Evaluation Board Schematic](#) for component values).  $T_A = 25^\circ C$ , unless otherwise noted. **Bold** values indicate  $-40^\circ C \leq T_J \leq +125^\circ C$ .

Parameter	Conditions	Min.	Typ.	Max.	Unit
<b>Synchronous Buck (<math>V_{OUT1} - V_{OUT5}</math>)</b>					
<b>Buck Output Voltage Accuracy (<math>OUT[1-5]</math>)</b>					
Typical Output Voltage 1 Accuracy <sup>(11)</sup>	Includes Load, Line and Reference	<b>-1.5%</b>		<b>1.5%</b>	%
Typical Output Voltage 2 Accuracy <sup>(11)</sup>	Includes Load, Line and Reference	<b>-1.5%</b>		<b>1.5%</b>	%
Typical Output Voltage 3 Accuracy <sup>(11)</sup>	Includes Load, Line and Reference	<b>-1.5%</b>		<b>1.5%</b>	%
Typical Output Voltage 4 Accuracy <sup>(11)</sup>	Includes Load, Line and Reference	<b>-1.5%</b>		<b>1.5%</b>	%
Typical Output Voltage 5 Accuracy <sup>(11)</sup>	Includes Load, Line and Reference	<b>-1.5%</b>		<b>1.5%</b>	%
Output Voltage 1 Accuracy <sup>(11)</sup>		<b>-1%</b>		<b>1%</b>	%
Output Voltage 2 Accuracy <sup>(11)</sup>		<b>-1%</b>		<b>1%</b>	%
Output Voltage 3 Accuracy <sup>(11)</sup>		<b>-1%</b>		<b>1%</b>	%
Output Voltage 4 Accuracy <sup>(11)</sup>		<b>-1%</b>		<b>1%</b>	%
Output Voltage 5 Accuracy <sup>(11)</sup>		<b>-1%</b>		<b>1%</b>	%
Load Regulation	$I_{OUT} = 10mA$ to $I_{OUT(MAX)}$		0.1		%
Line Regulation	$V_{IN} = 3.3V$ to $5.0V$		0.05		%
<b>Buck Soft-Start</b>					
Soft-Start (1-5) LSB <sup>(10, 12)</sup>		3.84	4	4.16	$\mu s/step$
<b>Buck Internal MOSFETs</b>					
High-Side On-Resistance	$V_{IN} = 3.3V$ ; $I_{SW[1-5]} = 200mA$		54		m $\Omega$
High-Side On-Resistance	$V_{IN} = 5.0V$ ; $I_{SW[1-5]} = 200mA$		40		m $\Omega$
Low-Side On-Resistance	$V_{IN} = 3.3V$ ; $I_{SW[1-5]} = -200mA$		37		m $\Omega$
Low-Side On-Resistance	$V_{IN} = 5.0V$ ; $I_{SW[1-5]} = -200mA$		30		m $\Omega$
Output Pull-Down Resistance	$V_{SW[1-5]} = 0V$	75	90	200	$\Omega$
<b>Buck Controller Timing</b>					
Fixed On-Time <sup>(13)</sup>	$V_{IN} = 3.3$ ; $V_{OUT} = 1.0V$ ; $I_{OUT} = 1.0A$		220		ns
Minimum OFF-Time			80		ns

**Note:**

11. Not tested in a closed loop configuration.

12. The soft-start time is calculated using the following equation:  $t_{softstart} = [(V_{OUT\_PROGRAM} - 0.15)/0.05 + 1] \times t_{RAMP}$ .

13. Buck frequency is calculated using the following equation  $f_{SW} = (V_{OUT}/V_{IN}) \times (1/t_{ON})$ .

## Electrical Characteristics<sup>(7)</sup> (Continued)

$V_{IN} = AV_{IN} = PV_{IN(1-6)} = 5.0V$ ;  $V_{OUT1} = 1.8V$ ;  $V_{OUT2} = 1.1V$ ;  $V_{OUT3} = 1.8V$ ;  $V_{OUT4} = 1.05V$ ;  $V_{OUT5} = 1.25V$ ;  $V_{OUT6} = 12V$  (refer to the [Evaluation Board Schematic](#) for component values).  $T_A = 25^\circ C$ , unless otherwise noted. **Bold** values indicate  $-40^\circ C \leq T_J \leq +125^\circ C$ .

Parameter	Conditions	Min.	Typ.	Max.	Unit
<b>Buck Current Limit (OUT1-OUT5)</b>					
Buck 1 Current Limit Threshold	See <a href="#">Table 25</a> for $I_{PROG}$ Settings	3.075	4.1	5.125	A
Buck 2 Current Limit Threshold	See <a href="#">Table 25</a> for $I_{PROG}$ Settings	3.075	4.1	5.125	A
Buck 3 Current Limit Threshold	See <a href="#">Table 26</a> for $I_{PROG}$ Settings	3.075	4.1	5.125	A
Buck 4 Current Limit Threshold	See <a href="#">Table 26</a> for $I_{PROG}$ Settings	4.88	6.1	7.32	A
Buck 5 Current Limit Threshold	See <a href="#">Table 27</a> for $I_{PROG}$ Settings	3.075	4.1	5.125	A
Gross High-Side Current Limit [1-5]	With Respect to Buck [x] Current Limit		150		%
Zero Cross Threshold	Zero crossing detector		0		mV
<b>Boost (<math>V_{OUT6}</math>)</b>					
<b>Boost Output Voltage (<math>V_{OUT6}</math>)</b>					
Typical Output Voltage Accuracy <sup>(11)</sup>	Includes Load, Line, and Reference	<b>-1.5%</b>		<b>1.5%</b>	%
Output Voltage Accuracy <sup>(11)</sup>		<b>-1%</b>		<b>1%</b>	%
Load Regulation	$I_{OUT6} = 1.0mA$ to $200mA$		0.2		%
Line Regulation	$V_{IN} = 2.4V$ to $5.5V$ ; $I_{OUT6} = 10mA$		0.2		%
$V_{OUT6}$ Discharge Current	$V_{IN} = 3.3V$ ; $V_{OUT6} = 12V$	111	148	185	mA
<b>Boost Soft-Start Step Duration</b>					
Soft-Start 6 LSB <sup>(10, 12)</sup>		3.84	4	4.16	$\mu s/step$
<b>Boost Internal MOSFETs</b>					
Low-Side On-Resistance	$V_{IN} = 3.3V$ ; $I_{SW1} = -100mA$		160		m $\Omega$
Low-Side On-Resistance	$V_{IN} = 5.0V$ ; $I_{SW1} = -100mA$		140		m $\Omega$
<b>Boost Disconnect MOSFETs</b>					
Disconnect Switch On-Resistance	$I_{PVIN60} = 100mA$ ; $V_{IN} = 3.3V$		90		m $\Omega$
Disconnect Switch Current Limit			5		A
<b>Boost Switching Frequency</b>					
Switching Frequency (PWM Mode)		1.92	2	2.08	MHz
Minimum Duty Cycle		35	40	45	%
Maximum Duty Cycle		80	85	90	%
<b>Boost Current Limit</b>					
NMOS Current-Limit Threshold			2.24		A

## Electrical Characteristics<sup>(7)</sup> (Continued)

$V_{IN} = AV_{IN} = PV_{IN(1-6)} = 5.0V$ ;  $V_{OUT1} = 1.8V$ ;  $V_{OUT2} = 1.1V$ ;  $V_{OUT3} = 1.8V$ ;  $V_{OUT4} = 1.05V$ ;  $V_{OUT5} = 1.25V$ ;  $V_{OUT6} = 12V$  (refer to the [Evaluation Board Schematic](#) for component values).  $T_A = 25^\circ C$ , unless otherwise noted. **Bold** values indicate  $-40^\circ C \leq T_J \leq +125^\circ C$ .

Parameter	Conditions	Min.	Typ.	Max.	Unit
<b>I<sup>2</sup>C Interface</b>					
<b>I<sup>2</sup>C Interface (SCL, SDA)</b>					
Low Level Input Voltage				<b>0.4</b>	V
High Level Input Voltage		<b>1.2</b>			V
High Level Input Current		-200	0.01	200	nA
Low Level Input Current		-200	0.01	200	nA
SDA Pull-Down Resistance			20		$\Omega$
SDA Logic 0 Output Voltage	$I_{SDA} = 3mA$			<b>0.4</b>	V
CLK, DATA Pin Capacitance			0.7		pF
<b>I<sup>2</sup>C Interface Timing<sup>(10)</sup></b>					
SCL Clock Frequency	Standard Mode			<b>100</b>	kHz
	Fast Mode			<b>400</b>	
	High-Speed Mode <sup>(10)</sup>			<b>3.4</b>	MHz

# Typical Characteristics

**Buck Efficiency (LDCR = 0mΩ)  
vs. Output Current**

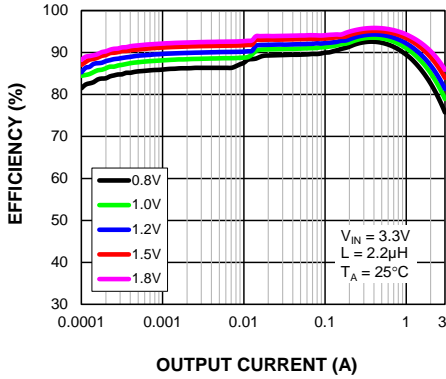

**Buck Efficiency (LDCR = 0mΩ)  
vs. Output Current**

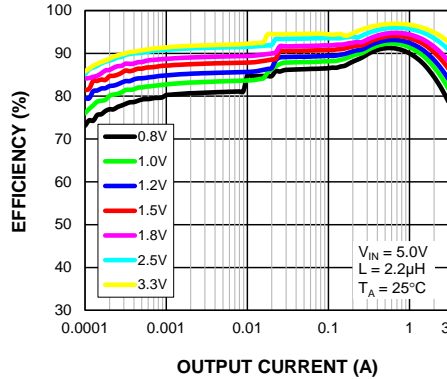

**Boost Efficiency (12V)  
vs. Output Current**

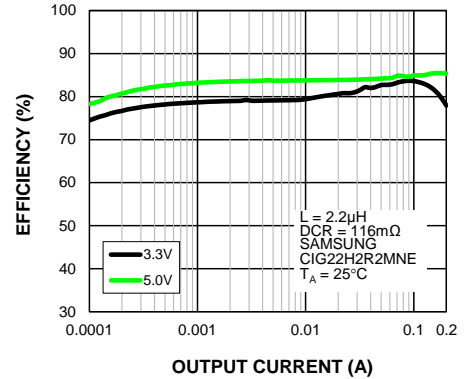

**Buck Efficiency (LDCR = 40mΩ)  
vs. Output Current**

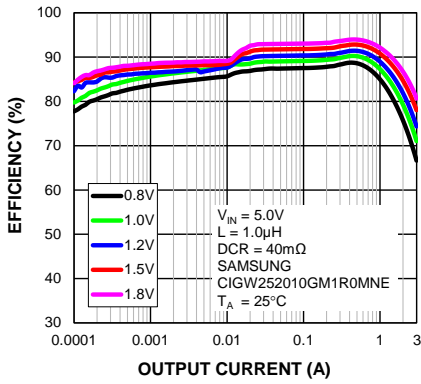

**Buck Efficiency (LDCR = 40mΩ)  
vs. Output Current**

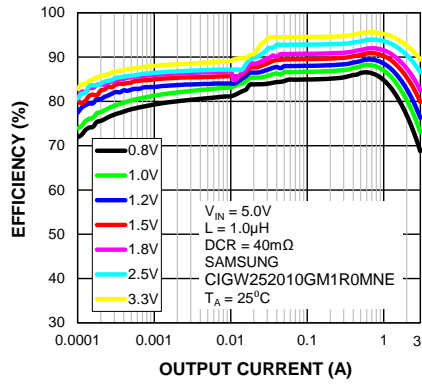

**Output Voltage  
vs. Output Current**

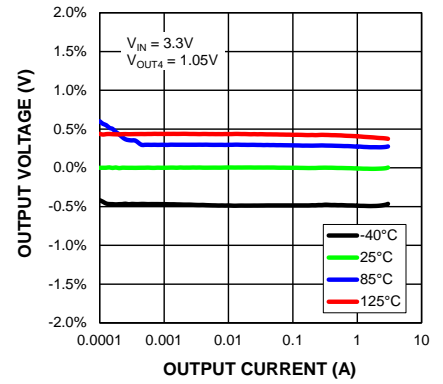

**Buck Efficiency (LDCR = 116mΩ)  
vs. Output Current**

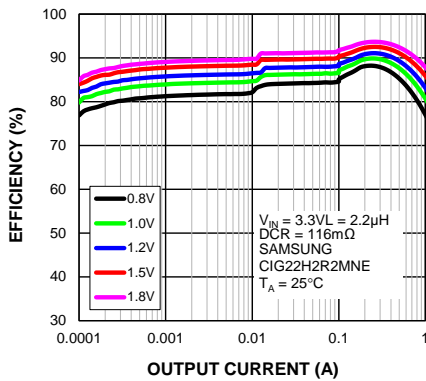

**Buck Efficiency (LDCR = 116mΩ)  
vs. Output Current**

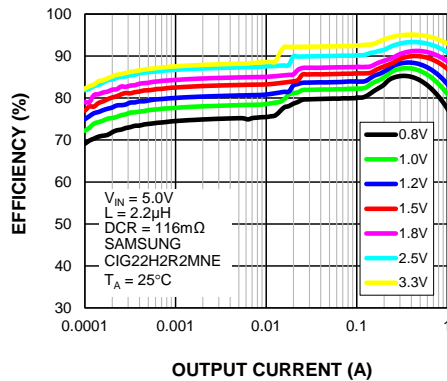

**Output Voltage  
vs. Temperature**

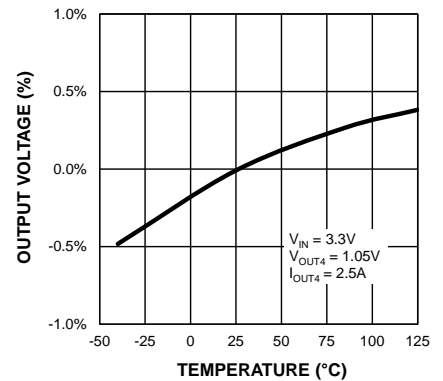

# Typical Characteristics (Continued)

**Buck Output Voltage (1.0V) vs. Output Current**

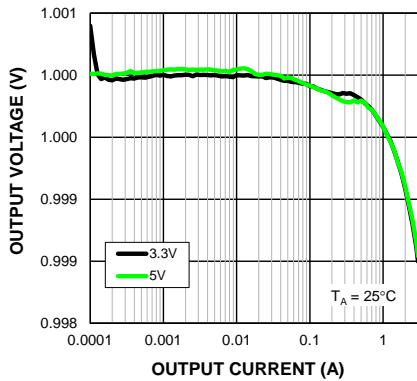

**Buck Output Voltage Regulation vs. Output Current**

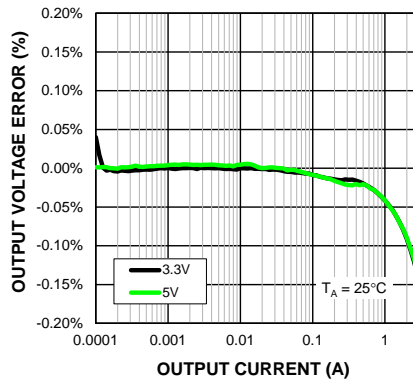

**Buck Line Regulation vs. Input Voltage**

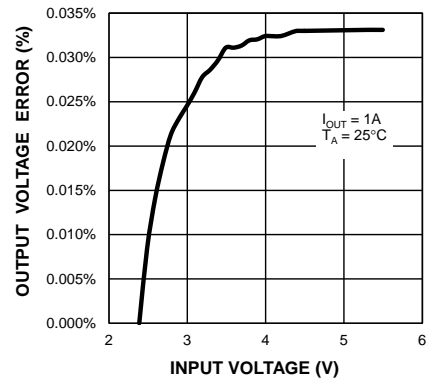

**Dropout Output Voltage vs. Output Current**

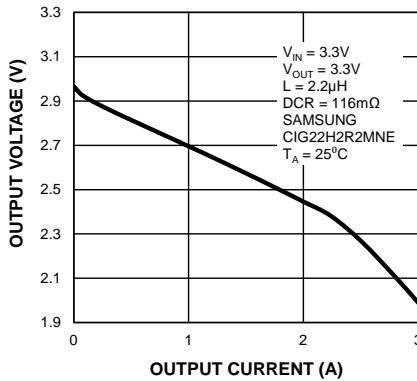

**V<sub>IN</sub> Operating Supply Current vs. Input Voltage**

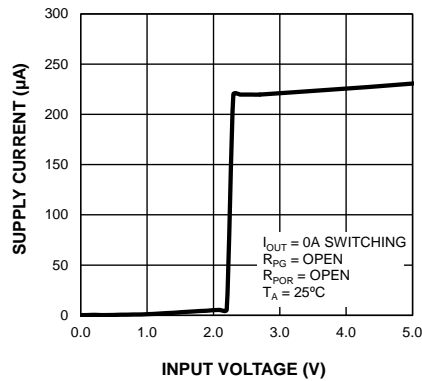

**Buck 2 Switching Frequency vs. Input Voltage**

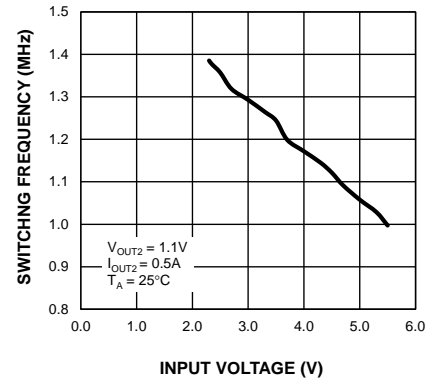

**V<sub>IN</sub> Shutdown Supply Current vs. Temperature**

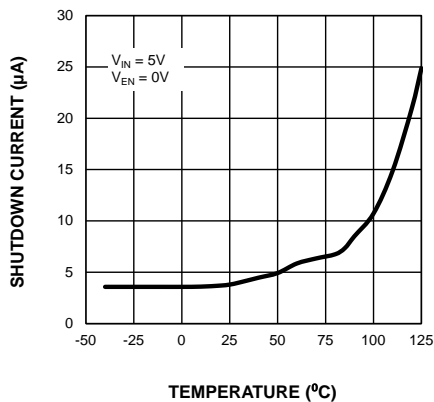

**V<sub>IN</sub> Supply Current vs. Temperature**

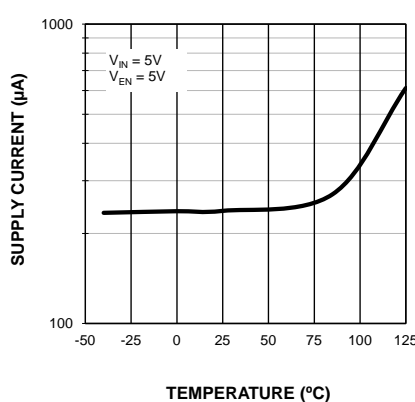

**Programmed Current Limit vs. Measured Current Limit**

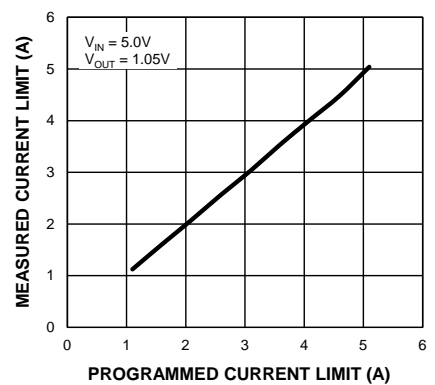



## Functional Characteristics

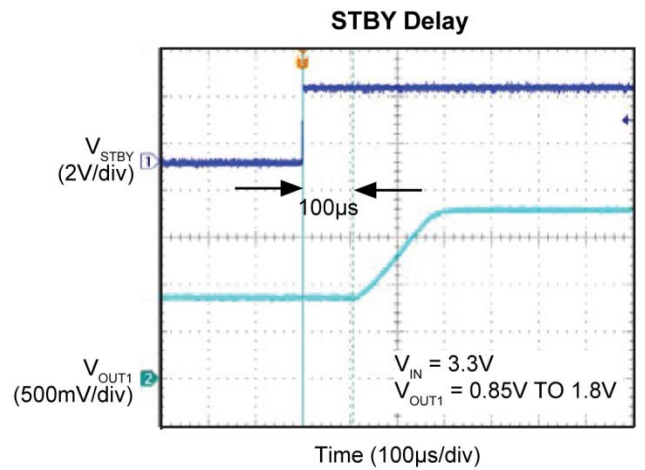
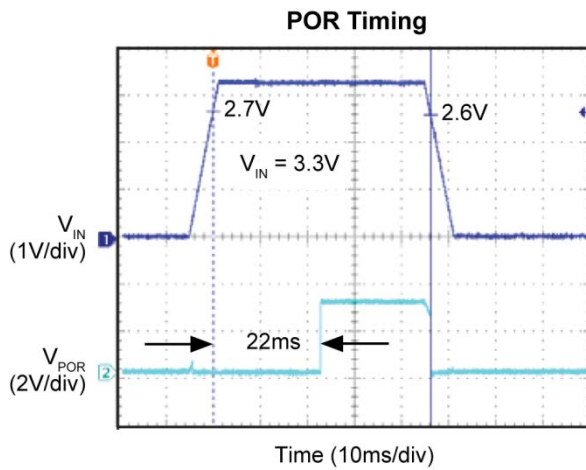
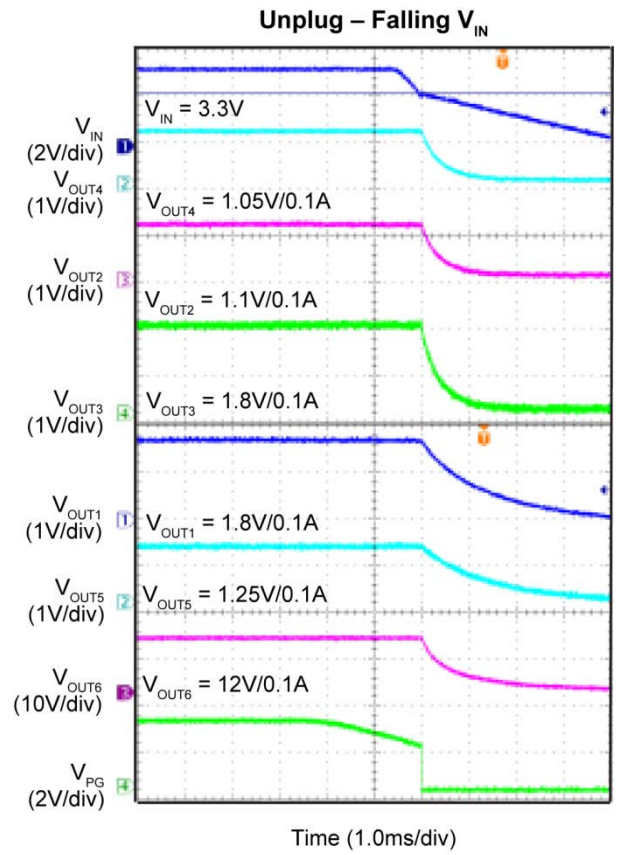
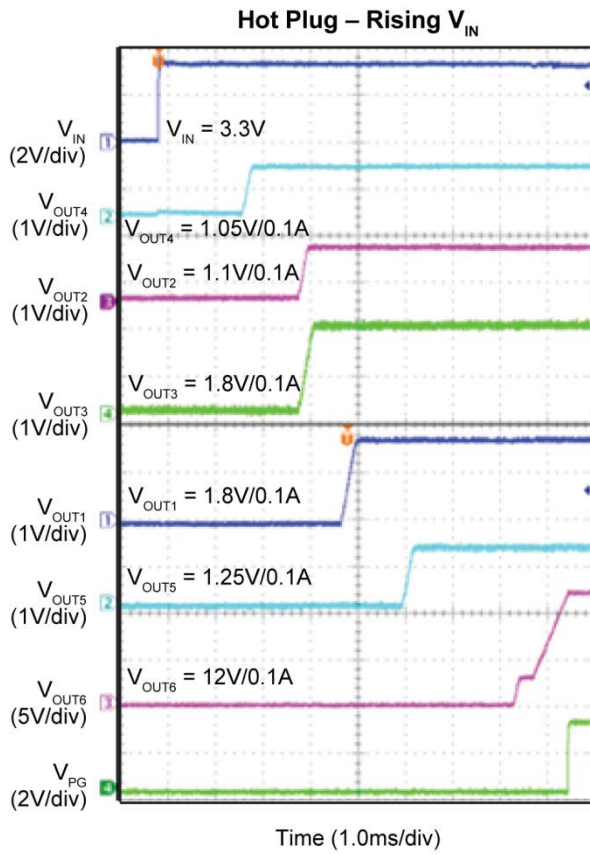

Functional Characteristics (Continued)

Buck Soft-Start

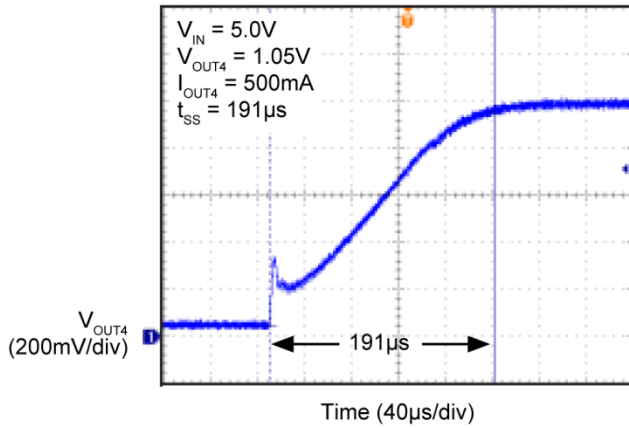

Boost Soft-Start

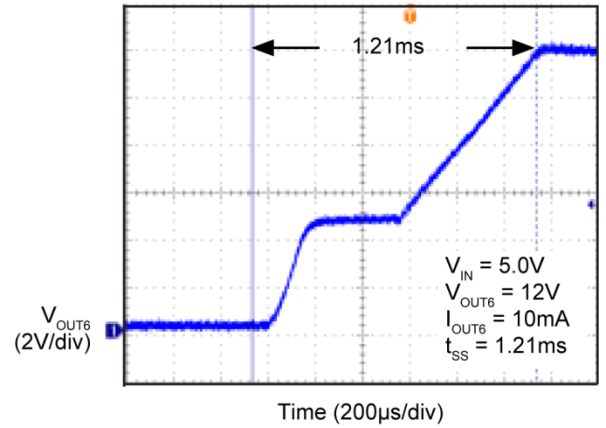

Standard Delay

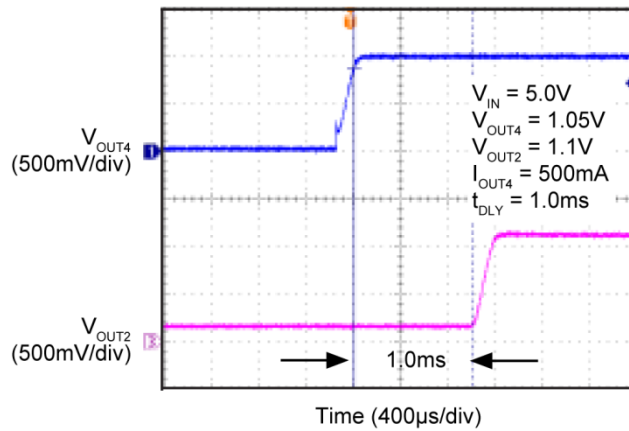

POR Delay

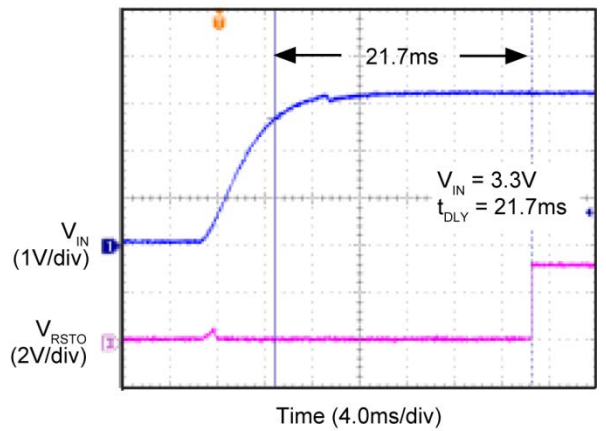

Output Pull-Down Resistance

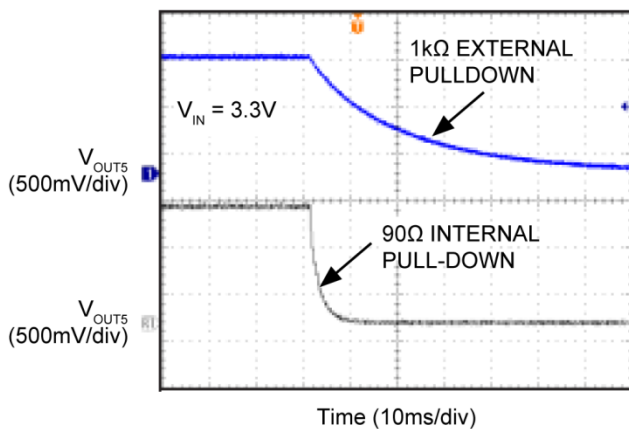

## Functional Characteristics (Continued)

**Buck 2 Load Transient – 10mA to 1A**

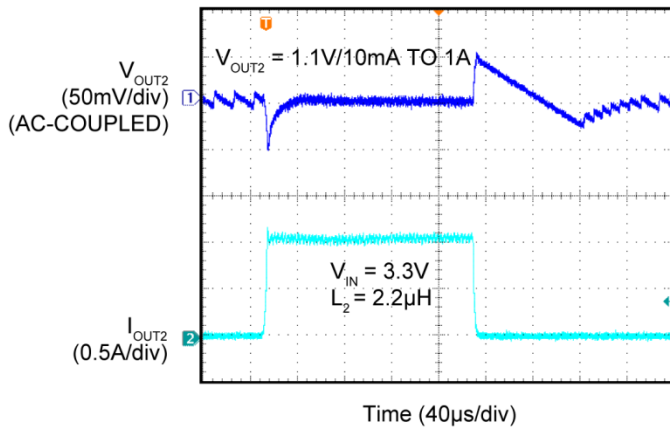

**Buck 4 Load Transient – 10mA to 3A**

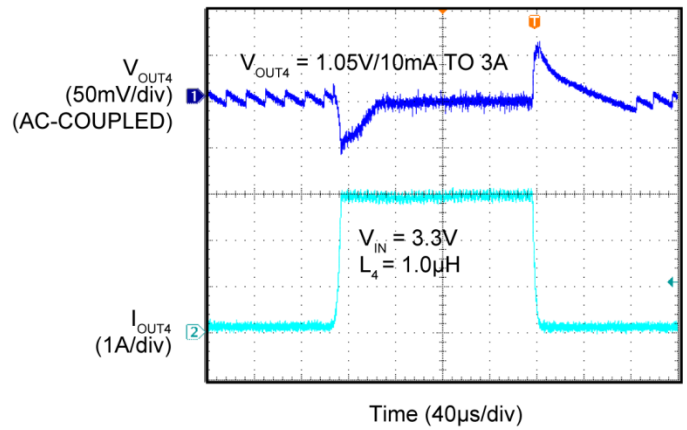

**Buck 2 Load Transient – 200mA to 1A**

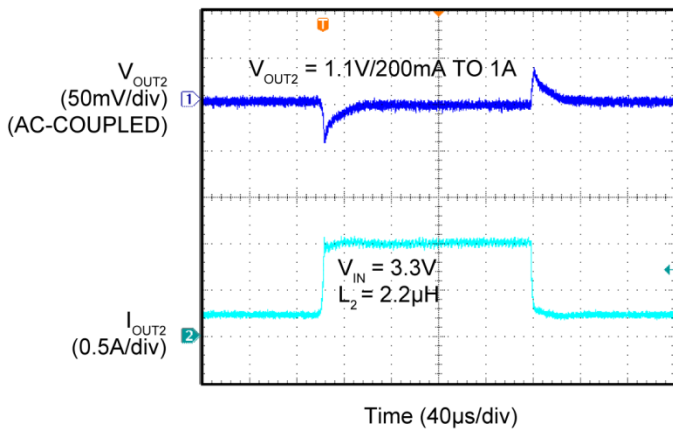

**Buck 4 Load Transient – 0.5A to 3A**

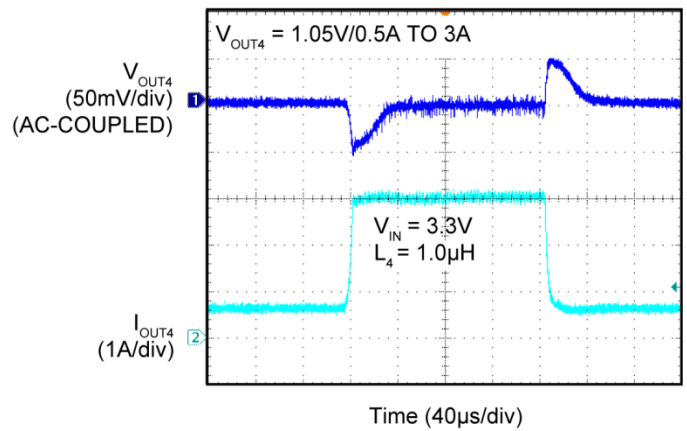

**Buck 2 Load Transient – 10mA to 0.2A**

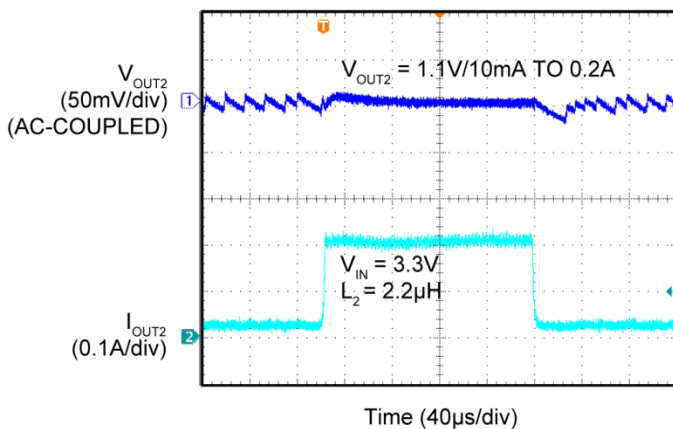

**Buck 4 Load Transient – 10mA to 0.5A**

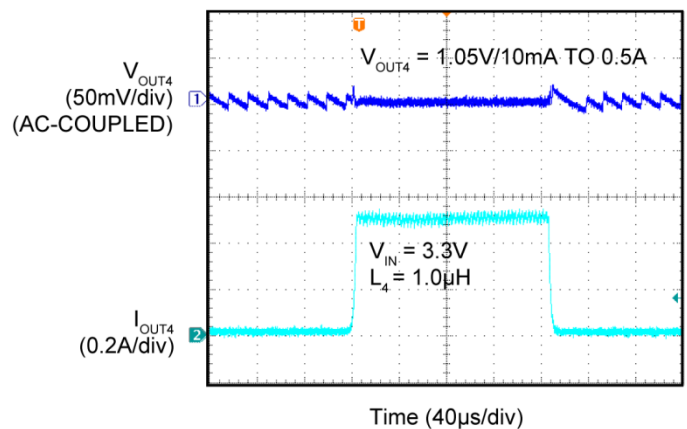

## Functional Characteristics (Continued)

**Boost 6 Load Transient – 10mA to 200mA**

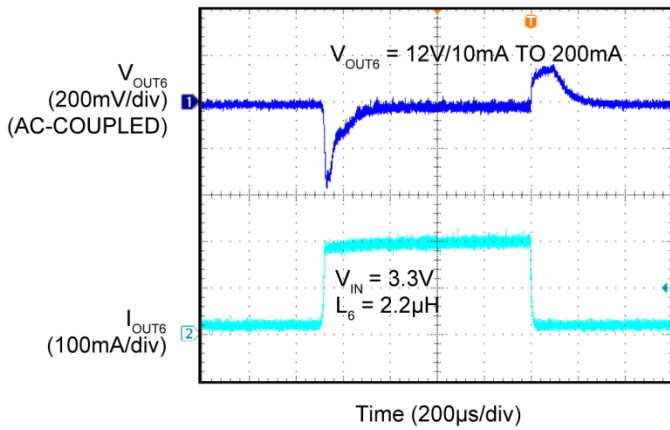

**Boost 6 Load Transient – 10mA to 50mA**

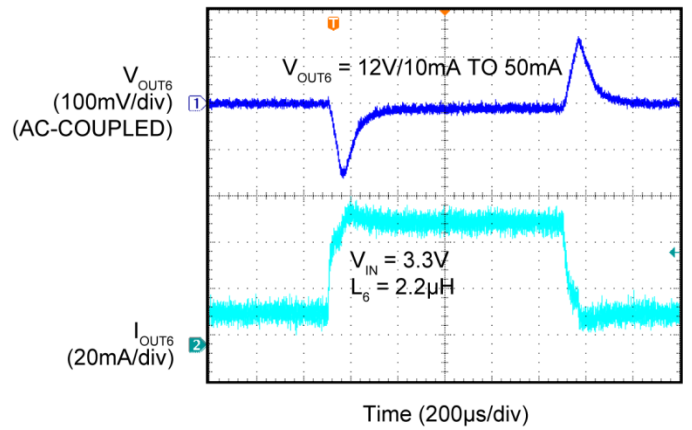

**Buck 4 Line Transient – 3.3V to 5.0V**

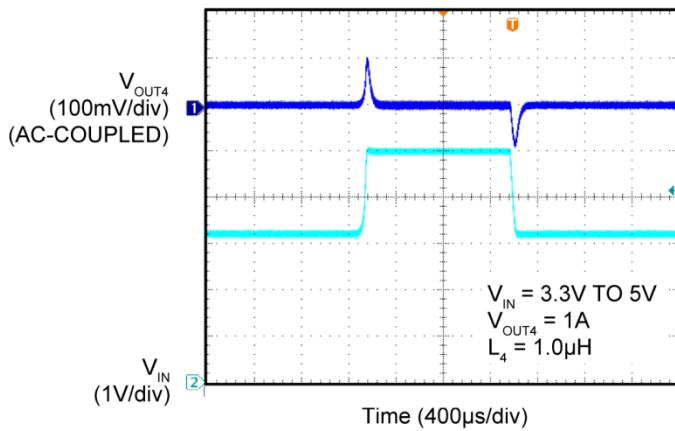

**Boost 6 Line Transient – 3.3V to 5.0V**

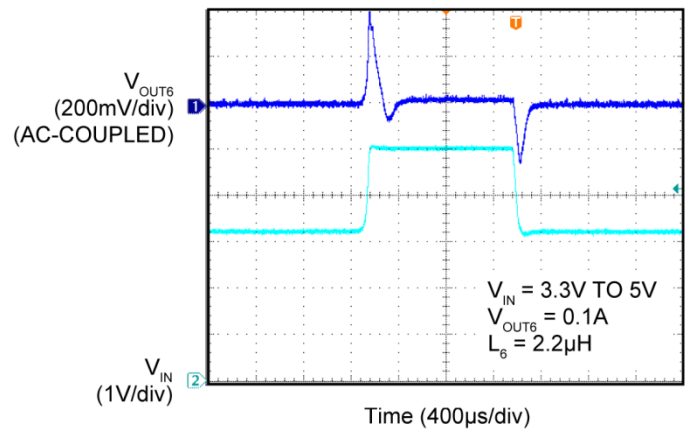

**Cross Regulation**

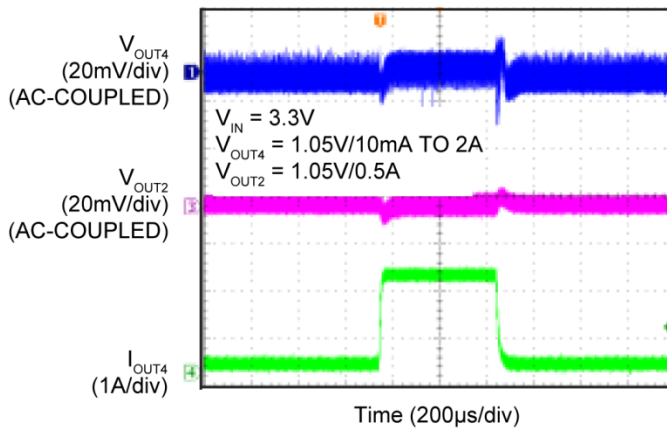

### Functional Characteristics (Continued)

**Buck 2 PWM Switching Waveforms**

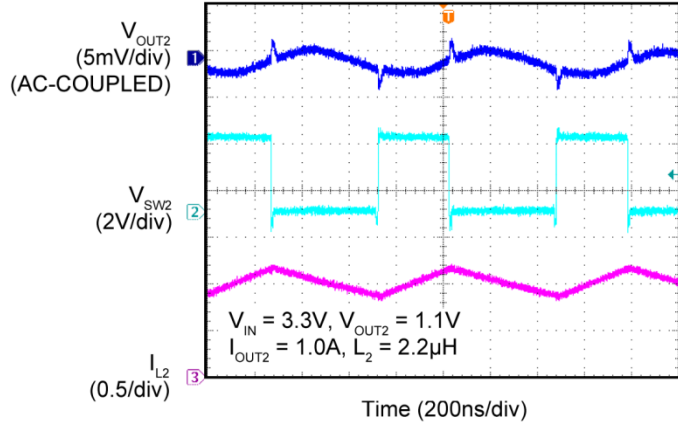

**Buck 2 PFM Switching Waveforms**

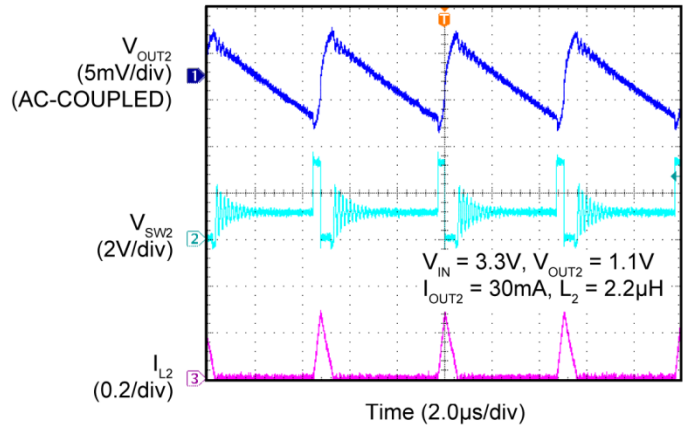

**Buck 4 PWM Switching Waveforms**

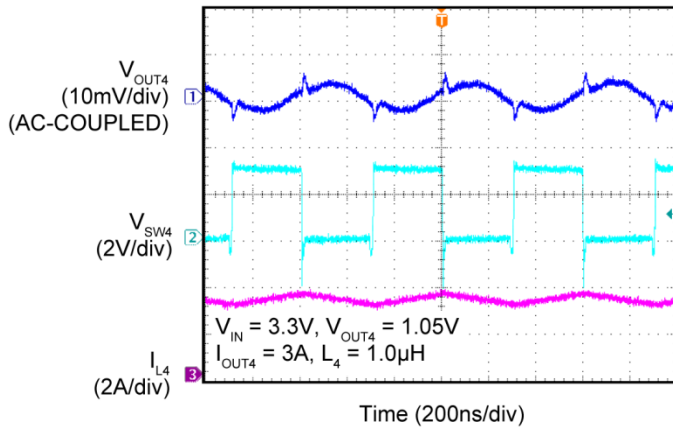

**Buck 4 PFM Switching Waveforms**

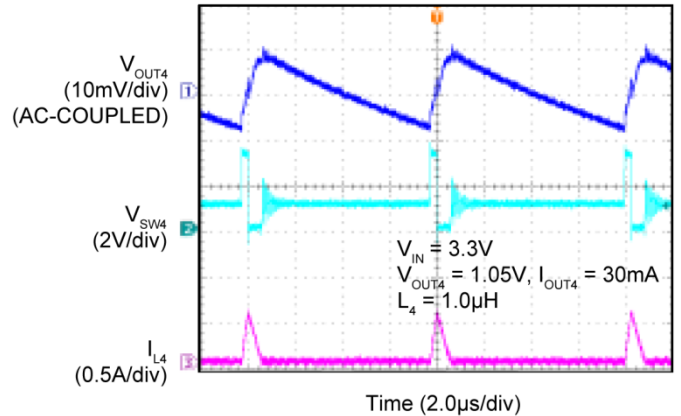

**Boost 6 PWM Switching Waveforms**

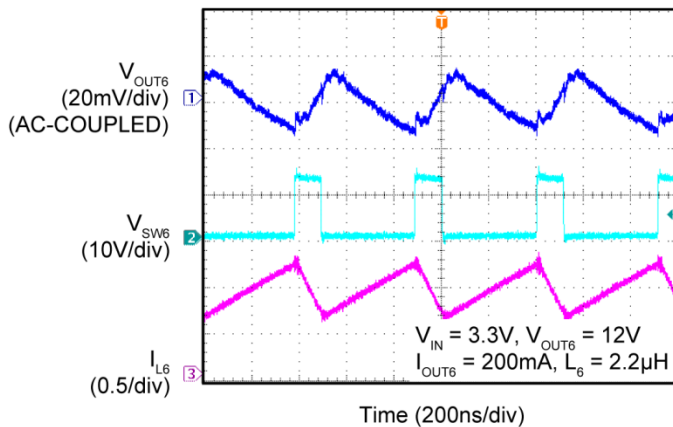

**Boost 6 PFM Switching Waveforms**

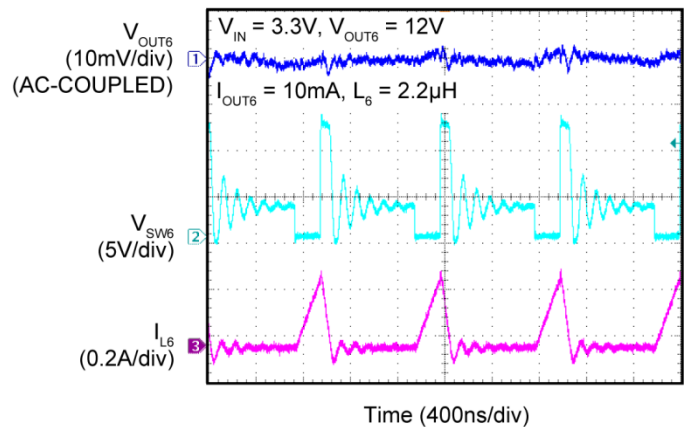



### Functional Characteristics (Continued)

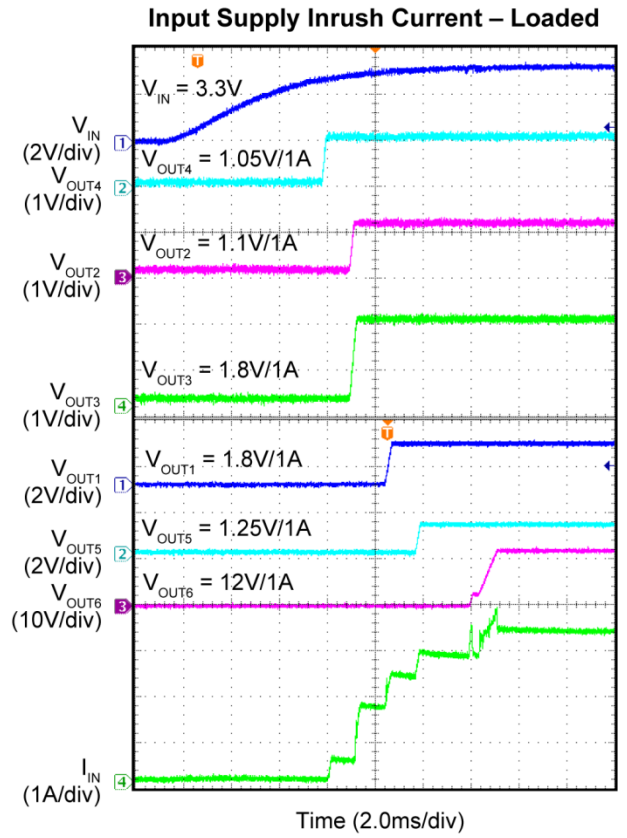
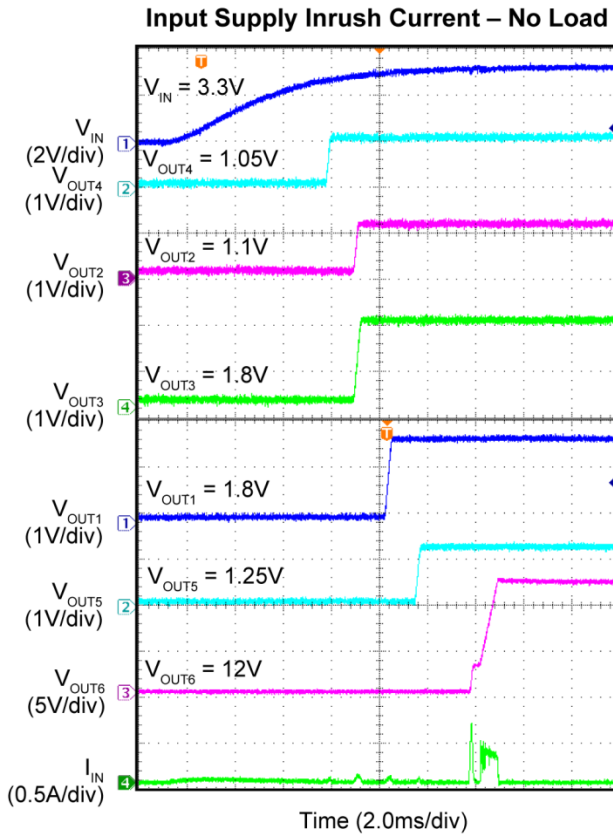

## Functional Characteristics (Continued)

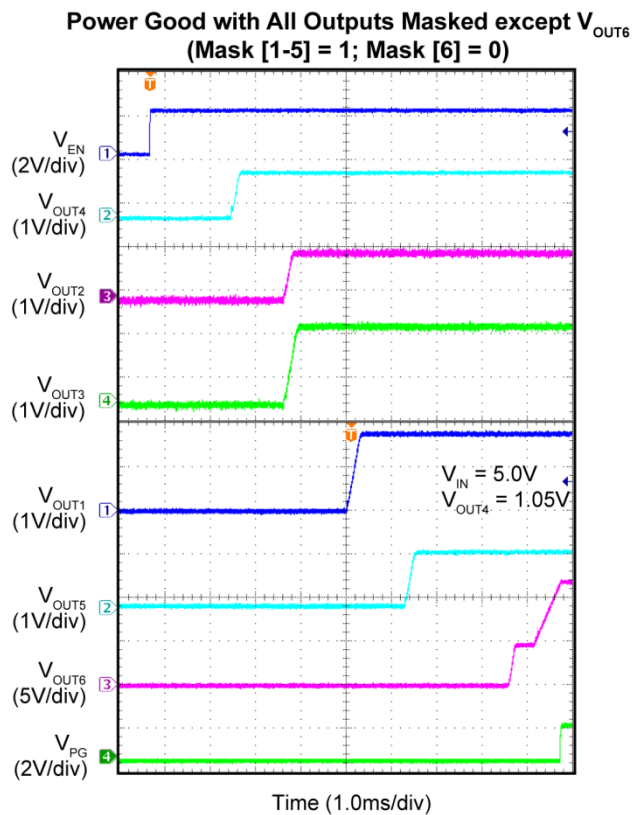
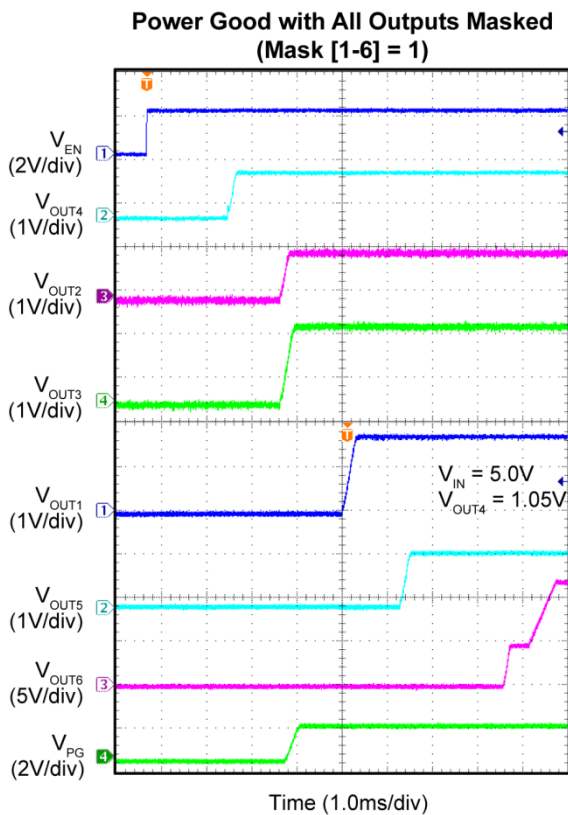
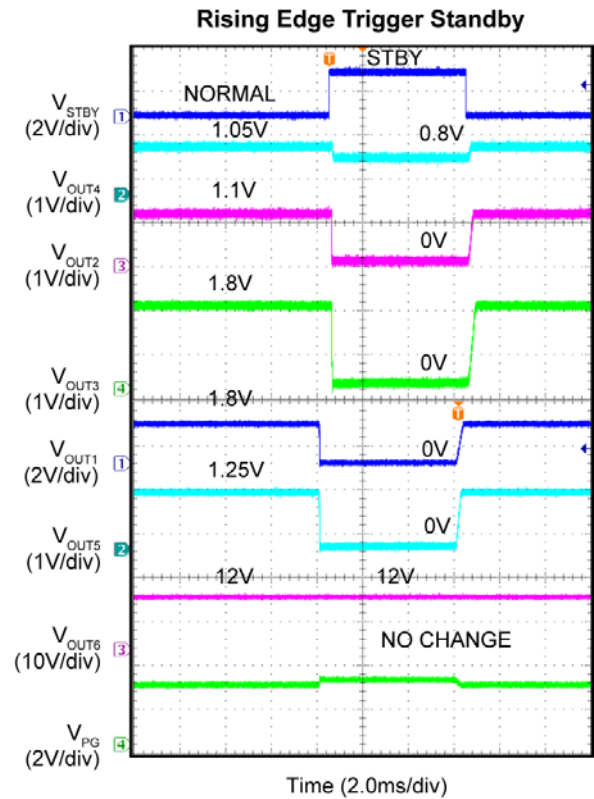
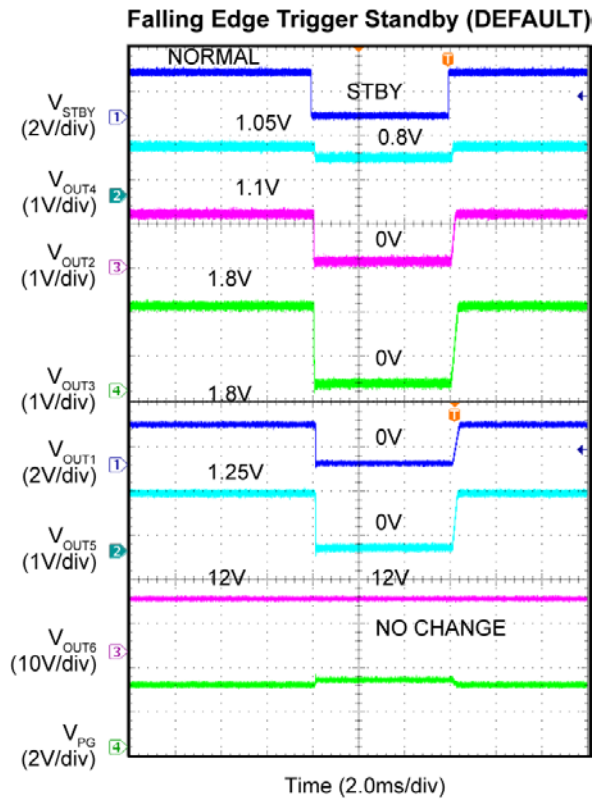

# MIC7401 Block Diagram

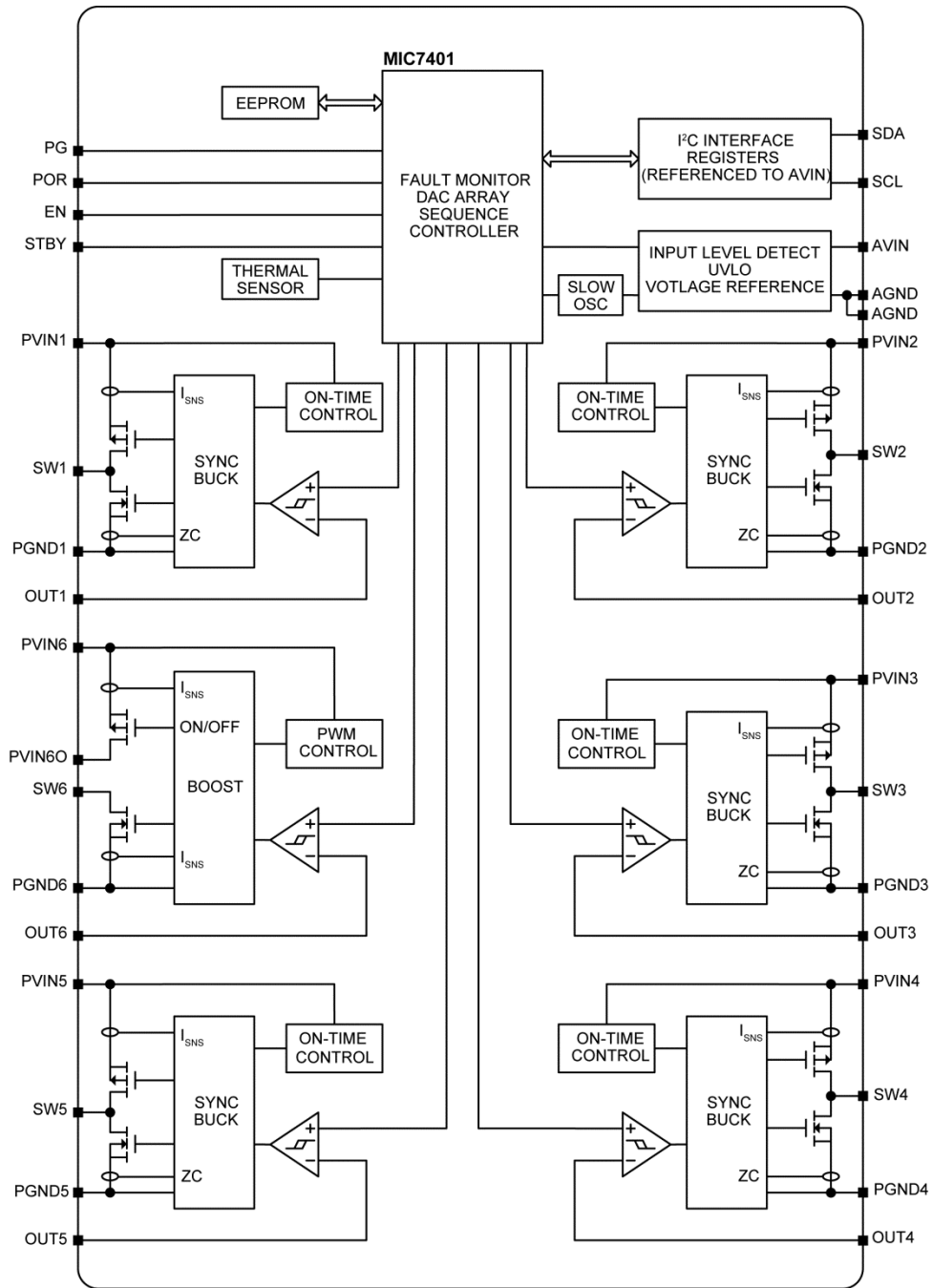



## Functional Description

The MIC7401 is one of the industry's most-advanced PMIC designed for solid state drives (SSD) on the market today. It is a multi-channel solution which offers software configurable soft-start, sequencing, and digital voltage control (DVC) that minimizes PC board area. These features usually require a pin for programming. However, this approach makes the IC larger by increasing pin count, and also increases BOM cost due to the external components.

The following is a complete list of programmable features:

- Buck output voltage (0.8V – 3.3V/50mV steps)
- Boost output voltage (7.0V – 14V/ 200mV steps)
- Power-on-reset (2.25V – 4.25V/50mV steps)
- Power-on-reset delay (5ms – 160ms/5ms steps)
- Power-up sequencing (6 time slots)
- Power-up sequencing delay (0ms – 7ms/1ms steps)
- Soft-start (4 $\mu$ s – 1024 $\mu$ s per step)
- Buck current limit threshold
  - (1.1A to 6.1A/0.5A steps)
- Boost current limit threshold
  - (1.76A to 2.6A/0.12A steps)
- Boost pull-down (37mA to 148mA/37mA steps)
- Buck pull-down (90 $\Omega$ )
- Buck standby output voltage programmable
- Boost standby output voltage programmable
- Global power good masking

These features give the system designer the flexibility to customize the MIC7401 for their application. For example,  $V_{OUT1}$  current limit can be programmed to 4.1A and  $V_{OUT2}$  can be set to 1.1A. These outputs can be programmed to come up at the same time or 2.0ms apart. In addition, in power-saving standby mode, the outputs can either be turned off or programmed to a lower voltage. With this programmability the MIC7401 can be used in multiple platforms.

The MIC7401 buck regulators are adaptive on-time synchronous step-down DC-to-DC regulators. They are designed to operate over a wide input voltage range from 2.4V to 5.5V and provide a regulated output voltage at up to 3.0A of output current. An adaptive on-time control scheme is employed to obtain a constant switching frequency and to simplify the control compensation. The device includes an internal soft-start function which reduces the power supply input surge current at start-up by controlling the output voltage rise time.

The MIC7401 has a current-mode boost regulator that can deliver up to 200mA of output current and only consumes 70 $\mu$ A of quiescent current. The 2.0MHz switching frequency allows small chip inductors to be used. Programmable overcurrent sensing protects the boost from overloads and an output disconnect switch opens to protect against a short-circuit condition. Soft-start is also programmable and controls both the rising and falling output.

### Programmable Buck Soft-Start Control

The MIC7401 soft-start feature forces the output voltage to rise gradually, which limits the inrush current during start-up. A slower output rise time will draw a lower input surge current. The soft-start time is based on the least significant bit (LSB) of an internal DAC and the speed of the ramp rate, as shown in Figure 1. This illustrates the soft-start waveform for all five synchronous buck converters. The initial step starts at 150mV and each subsequent step is 50mV.

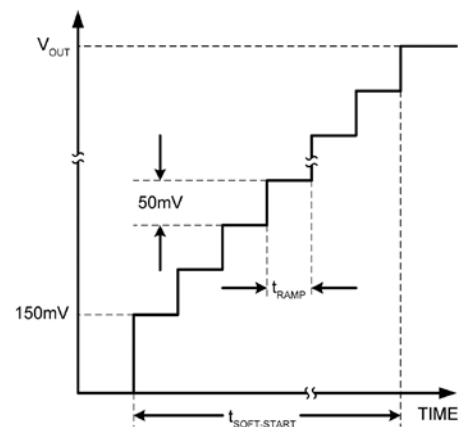

Figure 1. Buck Soft-Start

The output ramp rate ( $t_{RAMP}$ ) is set by the soft-start registers. Each output ramp rate can be individually set from 4 $\mu$ s to 1024 $\mu$ s, see Table 1 for details.

The soft-start time  $t_{SS}$  can be calculated by Equation 1:

$$t_{SS} = \left( \frac{V_{OUT} - 0.15V}{50mV} \right) \times t_{RAMP} \quad \text{Eq. 1}$$

Where:

$t_{SS}$  = Output rise time

$V_{OUT}$  = Output voltage

$t_{RAMP}$  = Output dwell time

For example:

$$t_{SS} = \left( \frac{1.8V - 0.15V}{50mV} \right) \times 8\mu s$$

$$t_{SS} = 264\mu s$$

Where:

$V_{OUT} = 1.8V$

$t_{RAMP} = 8.0\mu s$

**Table 1. Buck Outputs Default Soft-Start Time (DEFAULT)**

	$V_{OUT}$ (V)	$t_{RAMP}$ ( $\mu s$ )	$t_{SS}$ ( $\mu s$ )
$V_{OUT1}$	1.8	8	264
$V_{OUT2}$	1.1	8	152
$V_{OUT3}$	1.8	8	264
$V_{OUT4}$	1.05	8	144
$V_{OUT5}$	1.25	8	176

Figure 2 shows the output of Buck 1 ramping up cleanly, starting from 0.15V to its final 1.1V value.

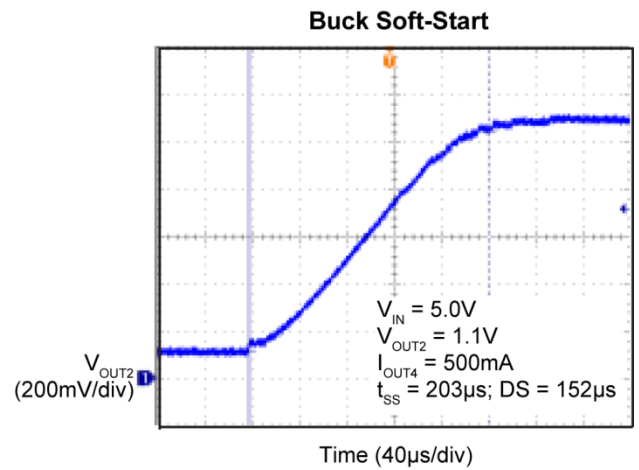

**Figure 2. Buck Soft-Start**

**Buck Digital Voltage Control (DVC)**

The output voltage has a 6-bit control DAC that can be programmed from 0.8V to 3.3V in 50mV increments. If the output is programmed to a higher voltage, then the output ramps up, as shown in Figure 3.

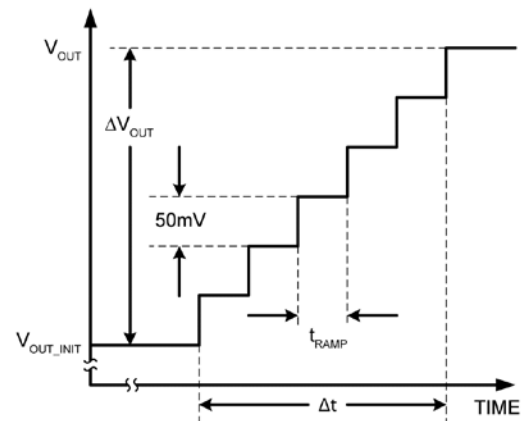

**Figure 3. Buck DVC Control Ramp**

The ramp time is determined by Equation 2:

$$\Delta t = \left( \frac{V_{OUT} - V_{OUT\_INIT}}{50mV} \right) \times t_{RAMP} \quad \text{Eq. 2}$$

Where:

$V_{OUT\_INIT}$  = Initial output voltage

$V_{OUT}$  = Final output voltage

$t_{RAMP}$  = Output dwell time

When the regulator is set in stand-by mode or programmed to a lower voltage, then the output voltage ramps down at a rate determined by the output ramp rate ( $t_{RAMP}$ ), the output capacitance and the external load. Small loads result in slow output voltage decay and heavy loads cause the decay to be controlled by the DAC ramp rate.

In Figure 4,  $V_{OUT1}$  is switched to stand-by mode with an I<sup>2</sup>C command and then switched back to normal mode either by an I<sup>2</sup>C command or a low-to-high transition of the STBY pin. In this case, the rise and fall times are the same due to a 1A load on  $V_{OUT1}$ .

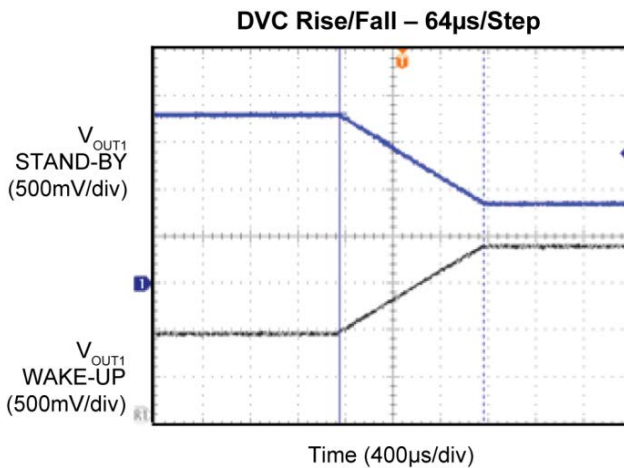

Figure 4. Buck DVC Control Ramp

### Programmable Boost Soft-Start Control

The boost soft-start time is divided into two parts as shown in Figure 5. T1 is a fixed 367µs delay starting from when the internal enable goes high. This delay gives enough time for the disconnect switch to turn on and bring the inductor voltage to  $V_{IN}$  before the boost is turned on. There is a 50µs delay which is controlled by the parasitic capacitance ( $C_{gd}$ ) of the disconnect switch before the output starts to rise.

After the T1 period, the DAC output ramp starts, T2. The total soft-start time,  $t_{SS}$ , is the sum of both periods. Figure 6 displays the actual boost soft-start waveform.

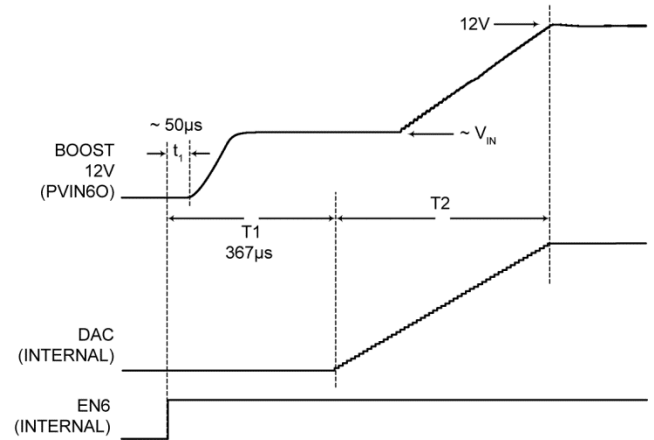

Figure 5. Boost Soft-Start Ramp

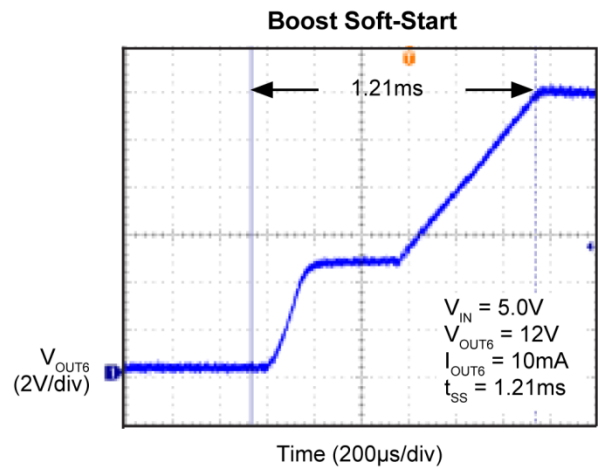

Figure 6. Boost Soft-Start

$$t_{SS} = T1 + T2$$

$$T2 = \left( \frac{V_{OUT} - 1.4V}{0.2V} \right) \times t_{RAMP} \quad \text{Eq. 2}$$

$$T2 = \left( \frac{(12V - 1.4V)}{0.2V} \right) \times 16\mu s$$

Where:

T1 = 367μs

T2 = 848μs

t<sub>SS</sub> = 367μs + 848μs = 1.215ms

V<sub>OUT</sub> = Output voltage

t<sub>RAMP</sub> = Output dwell time = 16μs

**Boost Digital Voltage Control (DVC)**

The boost output control works the same way as the buck, except that the voltage steps are 200mV, see [Figure 7](#). When the boost is programmed to a lower voltage the output ramps down at a rate determined by the output ramp rate (t<sub>RAMP</sub>), the output capacitance and the external load. During both the ramp up and down time, the power good output is blanked and will not imitate a fault flag if the power good mask bit is set to “1”.

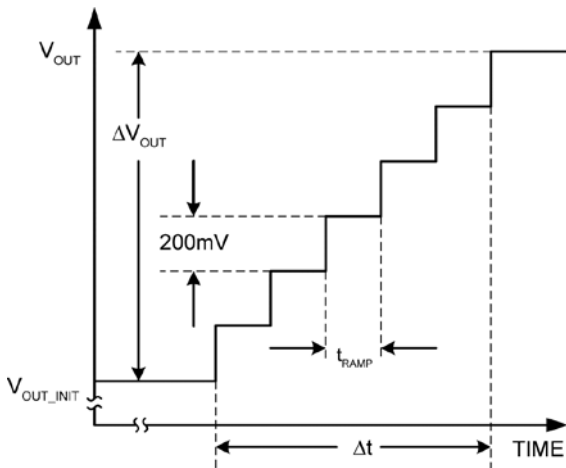

Figure 7. Boost DVC Control Ramp

The ramp time can be computed using Equation 3:

$$\Delta t = \left( \frac{V_{OUT} - V_{OUT\_INIT}}{0.2V} \right) \times t_{RAMP} \quad \text{Eq. 3}$$

Where:

V<sub>OUT\_INIT</sub> = Initial output voltage

**Table 2. Boost Output Default Soft-Start Time**

	V <sub>OUT</sub> (V)	t <sub>RAMP</sub> (μs)	t <sub>SS</sub> (ms)
V <sub>OUT6</sub>	12	16	1.215

**Buck Current Limit**

The MIC7401 buck regulators have high-side current limiting that can be varied by a 4-bit code. If the regulator remains in current limit for more than seven consecutive PWM cycles, the output is latched off, the over-current status register bit is set to 1, the power-good status register bit is set to 0 and the global power good (PG) output pin is pulled low. An over-current fault on one output will not disable the remaining outputs. [Table 3](#) shows the current limit register settings verses output current. The current limit register setting is set at twice the maximum output current.

**Table 3. Buck Current Limit Register Settings**

I <sub>OUT(MAX)</sub>	I <sub>PROG</sub>	BINARY	HEX
0.5A	1.1A	1111	F'h
1.0A	2.1A	1101	D'h
1.5A	3.1A	1011	B'h
2.0A	4.1A	1001	9'h
2.5A	5.1A	0111	7'h
3.0A	6.1A	0101	5'h

The output can be turned back on by recycling the input power or by software control. To clear the overcurrent fault by software control, set the enable register bit to “0” then clear the overcurrent fault by setting the fault register bit to “0”. This will clear the over-current and power good status registers. Now the output can be re-enabled by setting the enable register bit to “1”.

During start-up sequencing if Output 1 is still shorted, Outputs 2 through 4 will come up normally. Once an overcurrent condition is sensed, then the fault register is set to “1” and the start-up sequence will stop and no further outputs will be enabled. See Figure 9 for default start-up sequence.

### Boost Current Limit

The boost current limit features cycle-by-cycle protection. The duty cycle is cut immediately once the current limit is hit. When the boost current limit is hit for five consecutive cycles, the FAULT signal is asserted and remains asserted with the boost converter keeping on running until the boost is powered off.

This protects the boost in normal overload conditions, but not in a short-to-ground case. For a short circuit to ground, the boost current limit will not be able to limit the inductor current. This short-circuit condition is sensed by the current in the disconnect switch. When the disconnect switch current limit is hit for four consecutive master clock cycles (2MHz), regardless if the boost is switching or not, both the disconnect switch and boost are latched off automatically and the FAULT signal is asserted.

The output can be turned back on by recycling the input power or by software control. To clear the overcurrent fault by software control, set the enable register bit to “0” then clear the overcurrent fault by setting the fault register bit to “0”.

### Global Power Good Pin

The global power-good output indicates that all the outputs are above the 91% limit after the power-up sequence is completed. Once the power-up sequence is complete, the global power good output stays high unless an output falls below its power-good limit, a thermal fault occurs, the input voltage drops below the lower UVLO threshold or an output is turned OFF by setting the enable register bit to “0” unless the PGOOD\_MASK[x] bit is set to “1” (Default).

A power-good mask bit can be used to control the global power good output. The power-good mask feature is programmed through the PGOOD\_MASK[x] registers and is used to ignore an individual power-good fault. When masked, PGOOD\_MASK[x] bit is set to “1”, an individual power good fault will not cause the global power good output to de-assert.

If all the PGOOD\_MASK[x] bit are set to “1”, then the power good output de-asserts as soon as the first output starts to rise. The PGOOD\_MASK[x] bit of the last output must be set to “0” to have the PG output stay low until the last output reaches 91% of its final value.

The global power-good output is an open-drain output. A pull-up resistor can be connected to  $V_{IN}$  or  $V_{OUT}$ . Do not connect the pull-up resistor to a voltage higher than  $AV_{IN}$ .

### Standard Delay

There is a programmable timer that is used to set the standard delay time between each time slot. The timer starts as soon as the previous time slot's output power good goes high. When the delay completes, the regulators assigned to that time slot are enabled, see Figure 8.

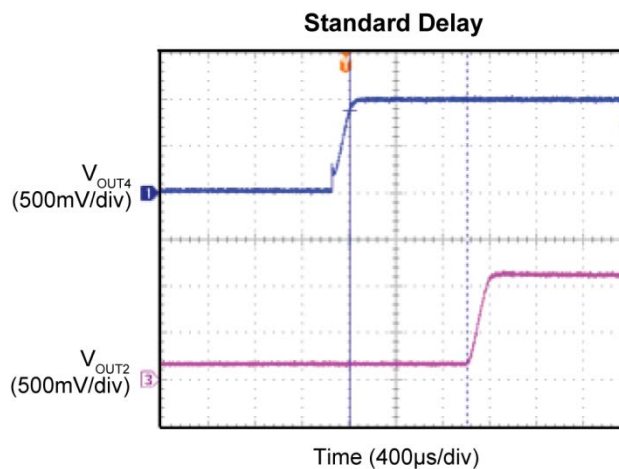

Figure 8. Standard Delay Time

### Power-Up Sequencing

When power is first applied to the MIC7401, all I<sup>2</sup>C registers are loaded with their default values from the EEPROM. There is about a 1.5ms delay before the first regulator is enabled while the MIC7401 goes through the initialization process. The DELAY register's STDEL bits set the delay between powering up each regulator at initial power up.

The sequencing registers allow the outputs to come up in any order. There are six time slots that an output can be configured to power up in. Each time slot can be programmed for up to six regulators to be turned on at once or none at all.

Figure 9 shows an example of this feature.  $V_{OUT4}$  is enabled in time slot 1. After a 1ms delay,  $V_{OUT2}$  and  $V_{OUT3}$  are enable at the same time in time slot 2. The 1ms is the standard delay for all of the outputs and can be programmed from 0ms to 7ms in 1ms. Next,  $V_{OUT1}$  is powered up in time slot 3 and  $V_{OUT5}$  in time slot 4. There are no regulators programmed for time slot 5. Finally,  $V_{OUT6}$  is powered up in time slot 6. The global power good output,  $V_{PG}$ , goes high as soon as the last output reaches 91% of its final value. Here the PGOOD\_MASK[6] bit is set to “0”.



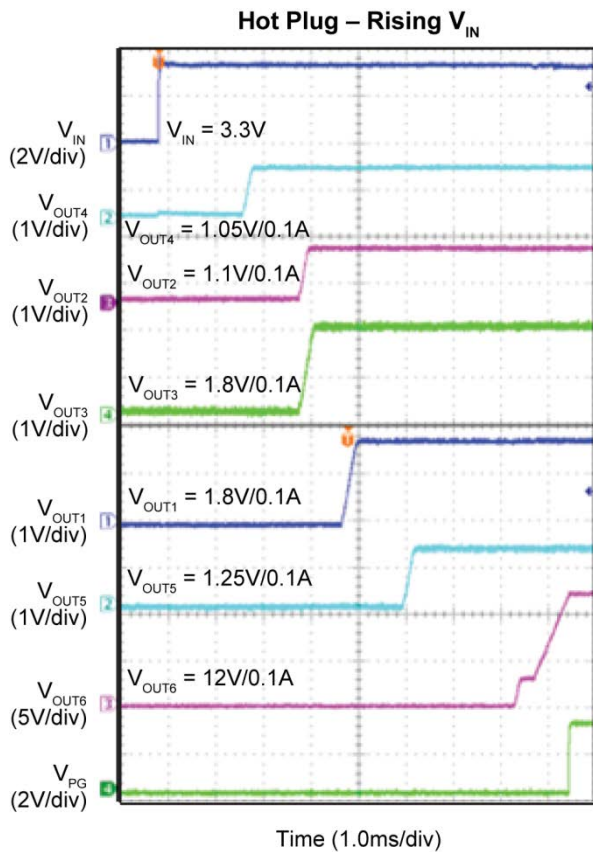

Figure 9. Hot Plug –  $V_{IN}$  Rising

**Global Enable Pin**

When the enable pin rises above the enable threshold voltage, the MIC7401 enters its start-up sequence.

**Programmable Power-on-Reset (POR) Delay**

The POR output pin provides the user with a way to let the SOC know that the input power is failing. If the input voltage falls below the power-on reset lower threshold level, the POR output immediately goes low. The lower threshold is set in the PORDN register and the upper threshold uses PORUP register.

The low-to-high POR transition can be delayed from 5ms to 160ms in 5ms increments. This feature can be used to signal the SOC that the power supplies are stable. The PORDEL register sets the delay of the POR pin. The POR delay starts as soon as the AVIN pin voltage rises above the power-on reset upper threshold limit. Figure 10 shows the POR operation.

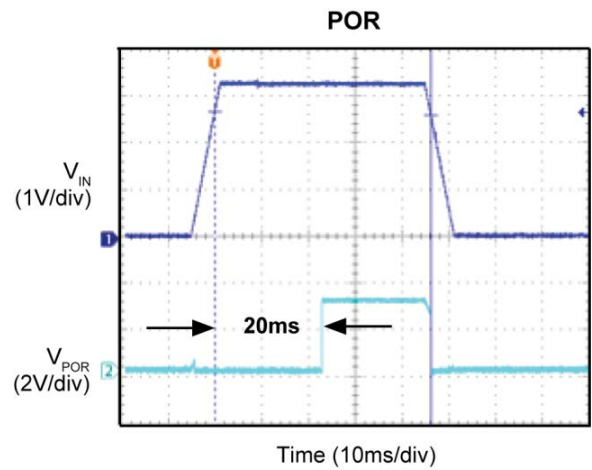

Figure 10. POR

**Power-Down Sequencing**

When power is removed from  $V_{IN}$ , all the regulators try to maintain the output voltage until the input voltage falls below the UVLO limit of 2.35V as shown in Figure 11.

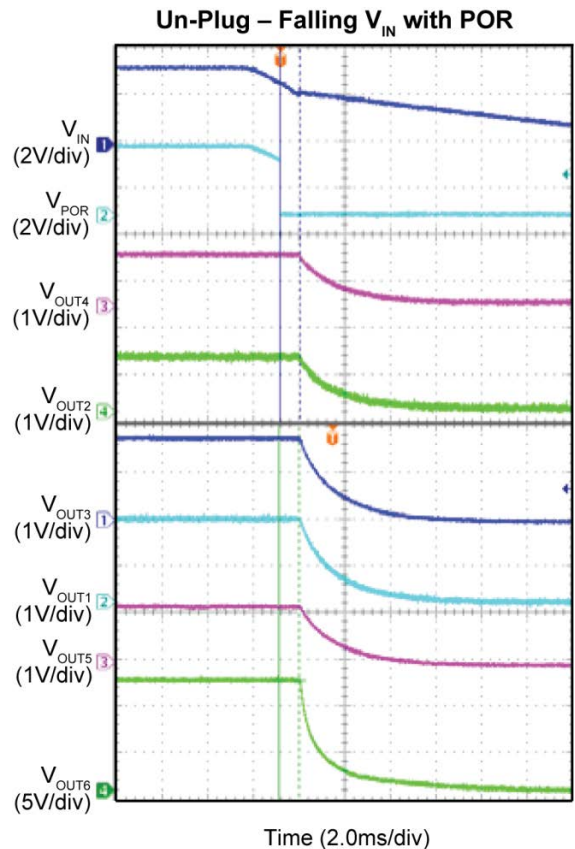

Figure 11. Hot Un-Plug –  $V_{IN}$  Falling

**Stand-By Mode**

In stand-by mode, efficiency can be improved by lowering the output voltage to the standby mode value or turning an output off completely. There are two registers used for setting the output voltage, normal-mode register and stand-by mode register. The default power-up voltages are set in the normal-mode registers.

An I<sup>2</sup>C write command to the STBY\_CTRL\_REG register or the STBY pin can be used to set the MIC7401 into stand-by mode. Figure 12 shows an I<sup>2</sup>C write command implementation. In stand-by mode, the output can be programmed to a lower voltage or turned completely off. When disabled, the output will be soft-discharged to zero if the PULLD[1-6] register are set to 1. If PULLD[x] = 0 the output drifts to PGND at a rate determined by the load current and output capacitance.

In stand-by, if an output is disabled, the global power good output is not affected when the PGOOD\_MASK[x] is set to logic 1. If the PGOOD\_MASK[x] is set to logic 0, then the global power good flag is pulled low. In Figure 12, all the PGOOD\_MASK[x] bits are set to logic 1.

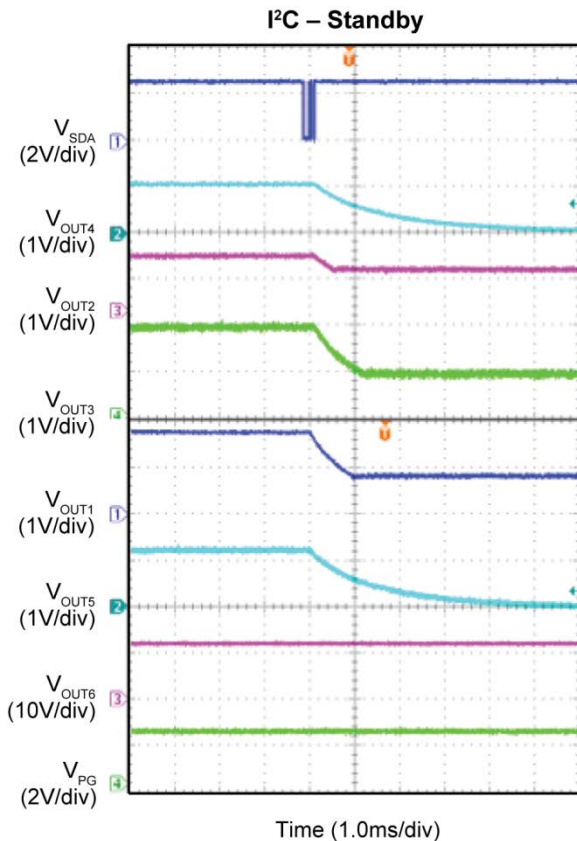

**Figure 12. I<sup>2</sup>C Stand-By Mode**

**Resistive Discharge**

To ensure a known output condition in stand-by mode, the output is actively discharged to ground if the output is disabled. Setting the buck pull down register field PULLD[1-5] = 1 connects a 90Ω pull down resistor from OUT[x] to PGND[x] when the MIC7401 is disabled. If PULLD[x] = 0 the output drifts to PGND at a rate determined by the load current and the output capacitance value. The boost has a programmable pull-down current level from 37mA to 148mA. In Figure 13, the top trace shows the normal pull down and the bottom trace is with the 90Ω pull-down.

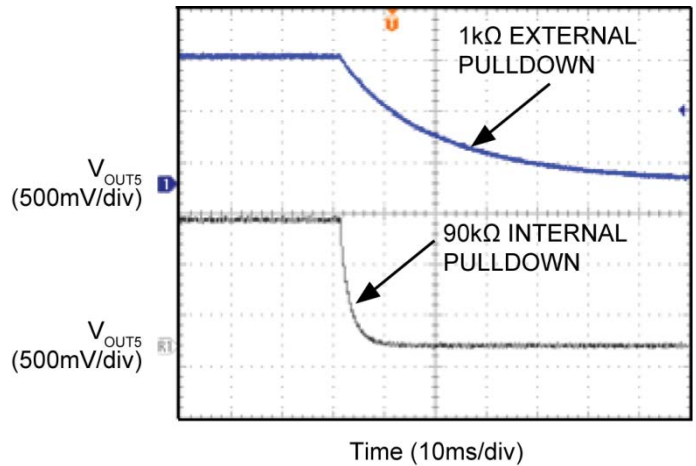

**Figure 13. Output Pull-Down Resistance**

**STBY Pin**

A pin-selectable STBY input allows the MIC7401 to be placed into standby or normal mode. In standby mode, the individual regulator can be turned on or off or the output voltage can be set to a different value. If the regulators are turned off, standby mode cuts the quiescent current by 23μA for each buck regulator and 70μA for the boost.

Figure 14 illustrates the STBY pin operation. A low-to-high transition on the STBY pin switches the output from standby mode to normal mode. There is a 100μs STBY deglitch time to eliminate nuisance tripping then all the regulators are enabled at the same time and ramp up with their programmed ramp rates. A high-to-low transition on the STBY pin switches the output from normal mode to standby mode.

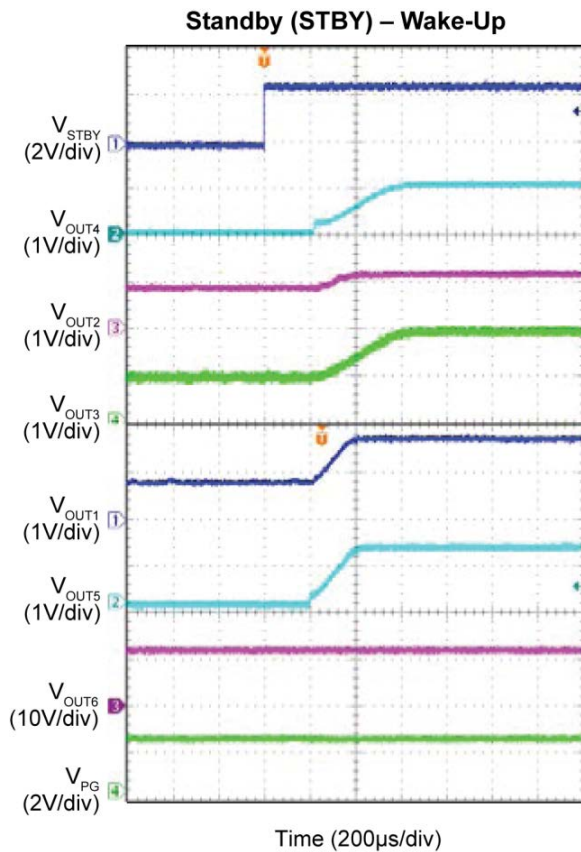

Figure 14. STBY-to-NORMAL Transition (DEFAULT)

**Safe Start-Up into a Pre-Biased Output**

The MIC7401 is designed for safe start-up into a pre-biased output. This prevents large negative inductor currents which can cause the output voltage to dip and excessive output voltage oscillations. A zero crossing comparator is used to detect a negative inductor current. If a negative inductor current is detected, the low-side synchronous MOSFET functions as a diode and is immediately turned off.

Figure 15 shows a 1V output pre-bias at 0.5V at start-up, see V<sub>OUT4</sub> trace. The inductor current, Trace I<sub>L4</sub>, is not allowed to go negative by more than 0.5A before the low-side switch is turned off. This feature prevents high negative inductor current flow in a pre-bias condition which can damage the IC.

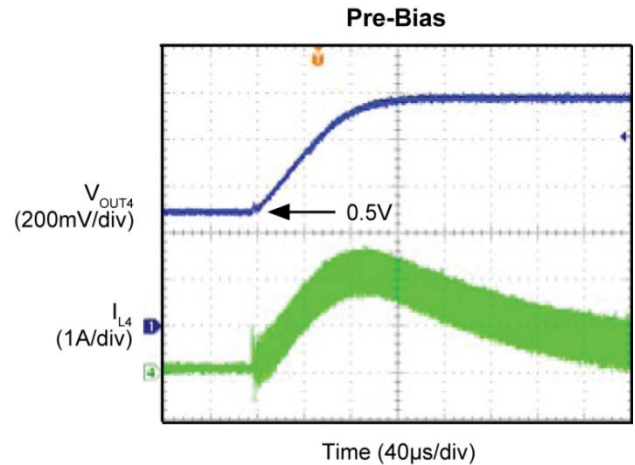

Figure 15. Pre-Biased Output Voltage

**Buck Regulator Power Dissipation**

The total power dissipation in a MIC7401 is a combination of the five buck regulators and the boost dissipation. The buck regulators (OUT1 to OUT5) dissipation is approximately the switcher’s input power minus the switcher’s output power and minus the power loss in the inductor:

$$P_{D\_BUCK} \approx V_{IN} \times I_{IN} - V_{OUT} \times I_{OUT} - P_{L\_LOSS} \quad \text{Eq. 4}$$

While the boost power dissipation is estimated by Equation 5:

$$P_{D\_BOOST} \approx V_{IN} \times I_{IN} - V_{OUT} \times I_{OUT} - P_{L\_LOSS} - V_f \times I_{OUT} \quad \text{Eq. 5}$$

Although the maximum output current for a single buck regulator can be as much as 3A, the MIC7401 will thermal limit and will not support this high output current on all outputs at the same time.

**Total Power Dissipation**

The total power dissipation in the MIC7401 package is equal to the sum of the power loss of each regulator:

$$P_{D\_TOTAL} \approx \text{SUM} (P_{D\_SWITCHERS}) \quad \text{Eq. 6}$$



Once the total power dissipation is calculated, the IC junction temperature can be estimated using Equation 7:

$$T_{J(MAX)} \approx T_A + P_{D\_TOTAL} \times \theta_{JA} \tag{Eq. 7}$$

Where:

$T_{J(MAX)}$  = The maximum junction temperature

$T_A$  = The ambient temperature

$\theta_{JA}$  = The junction-to-ambient thermal resistance of the package (30°C/W)

Figure 16 shows the measured junction temperature versus power dissipation of the MIC7401 evaluation board. The actual junction temperature of the IC depends upon many factors. The significant factors influencing the die temperature rise are copper thickness in the PCB, the surface area available for convection heat transfer, air flow and power dissipation from other components, including inductors, SOCs and processor ICs. It is good engineering practice to measure all power components temperature during the final design review using a thermal couple or IR thermometer, see the “[Thermal Measurements](#)” sub-section for details.

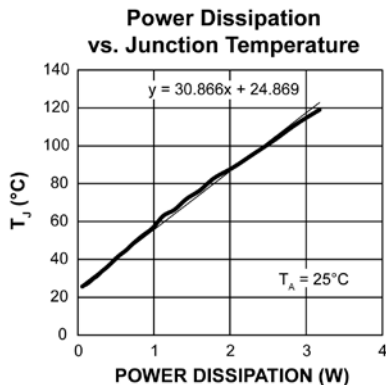

Figure 16. Power Dissipation

### Power Derating

The MIC7401 package has a 2W power dissipation limit. To keep the IC junction temperature below a 125°C design limit, the output power has to be limited above an ambient temperature of 65°C. Figure 17 shows the power dissipation derating curve.

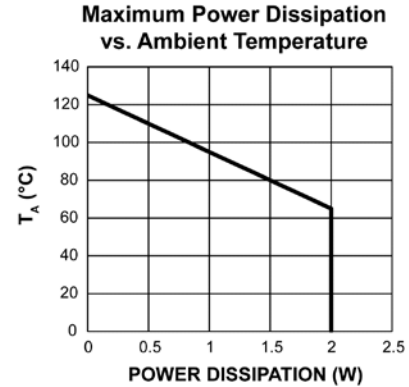

Figure 17. Power Derating Curve

The maximum power dissipation of the package can be calculated by Equation 8:

$$P_{D(MAX)} \approx \left( \frac{T_{J(MAX)} - T_A}{\theta_{JA}} \right) \tag{Eq. 8}$$

Where:

$T_{J(MAX)}$  = Maximum junction temperature (125°C)

$T_A$  = Ambient temperature

$\theta_{JA}$  = Junction-to-ambient thermal resistance of the package (30°C/W).

### Overtemperature Fault

An overtemperature fault is triggered when the IC junction temperature reaches 160°C. When this occurs, both the over temperature fault flag is set to 1, the global power good output is pulled low and all the outputs are turned off. During the fault condition the I<sup>2</sup>C interface remains active and all registers values are maintained.

When the die temperature decreases by 20°C the overtemperature fault bit can be cleared. To clear the fault, either recycle power or write a logic “0” to the over temperature fault register. Once the fault bit is cleared, the outputs power up to their default values and are sequenced according to the time slot settings.

### Input Voltage “Hot-Plug”

High-voltage spikes twice the input voltage can appear on the MIC7401 PVIN pins if a battery pack is hot-plugged to the input supply voltage connection as shown in Figure 18 (Trace 1). These spikes are due to the inductance of the wires to the battery and the very low inductance and ESR of the ceramic input capacitors. This problem can be solved by placing a 150 $\mu$ F POS capacitor across the input terminals. Figure 18 (Trace 2) shows that the high-voltage spike is greatly reduced to a value below the maximum allowable input voltage rating.

Whenever possible, an infrared thermometer is recommended. The measurement spot size of most infrared thermometers is too large for an accurate reading on a small form factor ICs. However, an IR thermometer from Optris has a 1mm spot size, which makes it a good choice for measuring the hottest point on the case. An optional stand makes it easy to hold the beam on the IC for long periods of time.

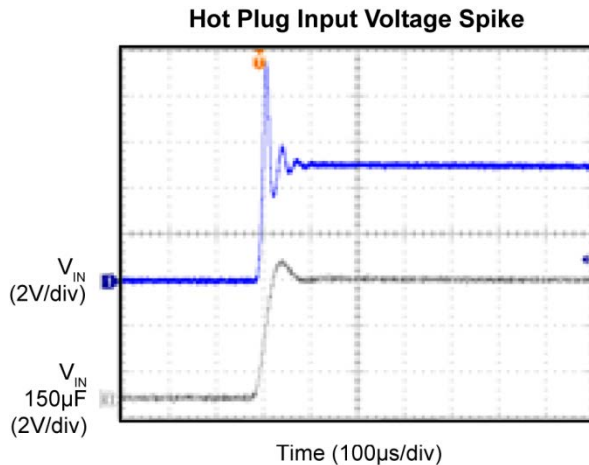

**Figure 18. Hot-Plug Input Voltage Spike**

### Thermal Measurements

Measuring the IC's case temperature is recommended to ensure it is within its operating limits. Although this might seem like a very elementary task, it is easy to get erroneous results. The most common mistake is to use the standard thermal couple that comes with a thermal meter. This thermal couple wire gauge is large (typically 22 gauge) and behaves like a heatsink, resulting in a lower case measurement.

Two reliable methods of temperature measurement are a smaller thermal couple wire or an infrared thermometer. If a thermal couple wire is used, it must be constructed of 36 gauge wire or higher (smaller wire size) to minimize the wire heat-sinking effect. In addition, the thermal couple tip must be covered in either thermal grease or thermal glue to make sure that the thermal couple junction is making good contact with the case of the IC. Omega brand thermal couple (5SC-TT-K-36-36) is adequate for most applications.

## Timing Diagrams

### Normal Power-Up Sequence for Outputs

The STDEL register sets the delay between powering up of each regulator at initial power-up (see power up sequencing in Figure 19). Once all the internal power good registers PGOOD[1-6] are all 1, then the global PG pin goes high without delay.

The PORDEL register sets the delay for the POR flag pin. The POR delay time starts as soon as AVIN pin voltage rises above the system UVLO upper threshold set by the PORUP register. The POR output goes low without delay if AVIN falls below the lower UVLO threshold set by the PORDN register.

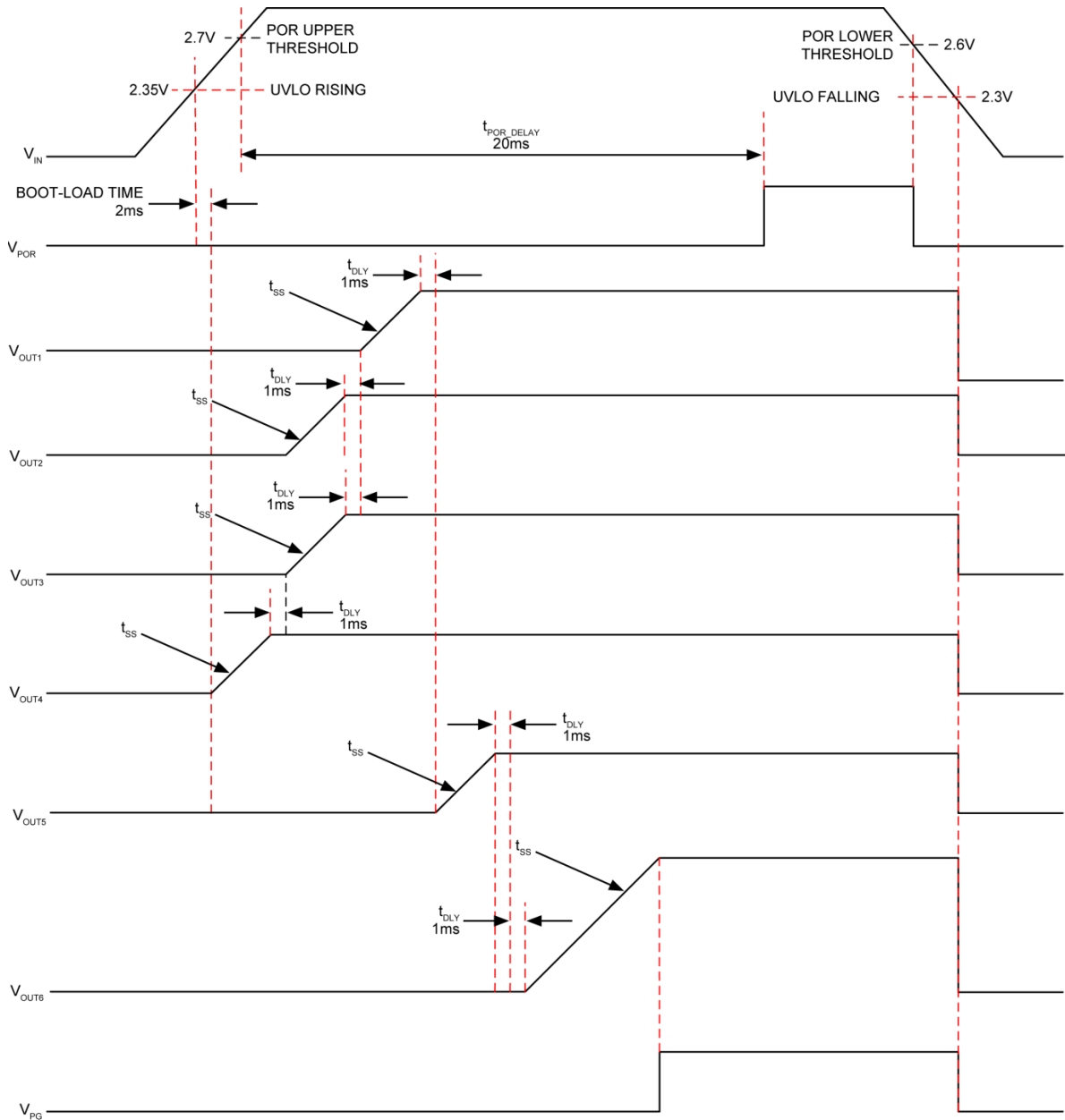

Figure 19. MIC7401 Power-Up/Down

### Standby (STBY) Pin (Wake-Up)

An I<sup>2</sup>C write command to the STBY\_CTRL\_REG register or the STBY pin can be used to set the MIC7401 into stand-by mode. The standby (STBY) pin provides a hardware-specific manner in which to wake-up from stand-by mode and go into normal mode. Figure 20 shows the STBY pin operation. A low-to-high transition on the STBY pin switches the output from stand-by mode to normal mode.

There is a 100µs STBY deglitch time to eliminate nuisance tripping then all the regulators are enabled at the same time and ramp up with their programmed ramp rates.

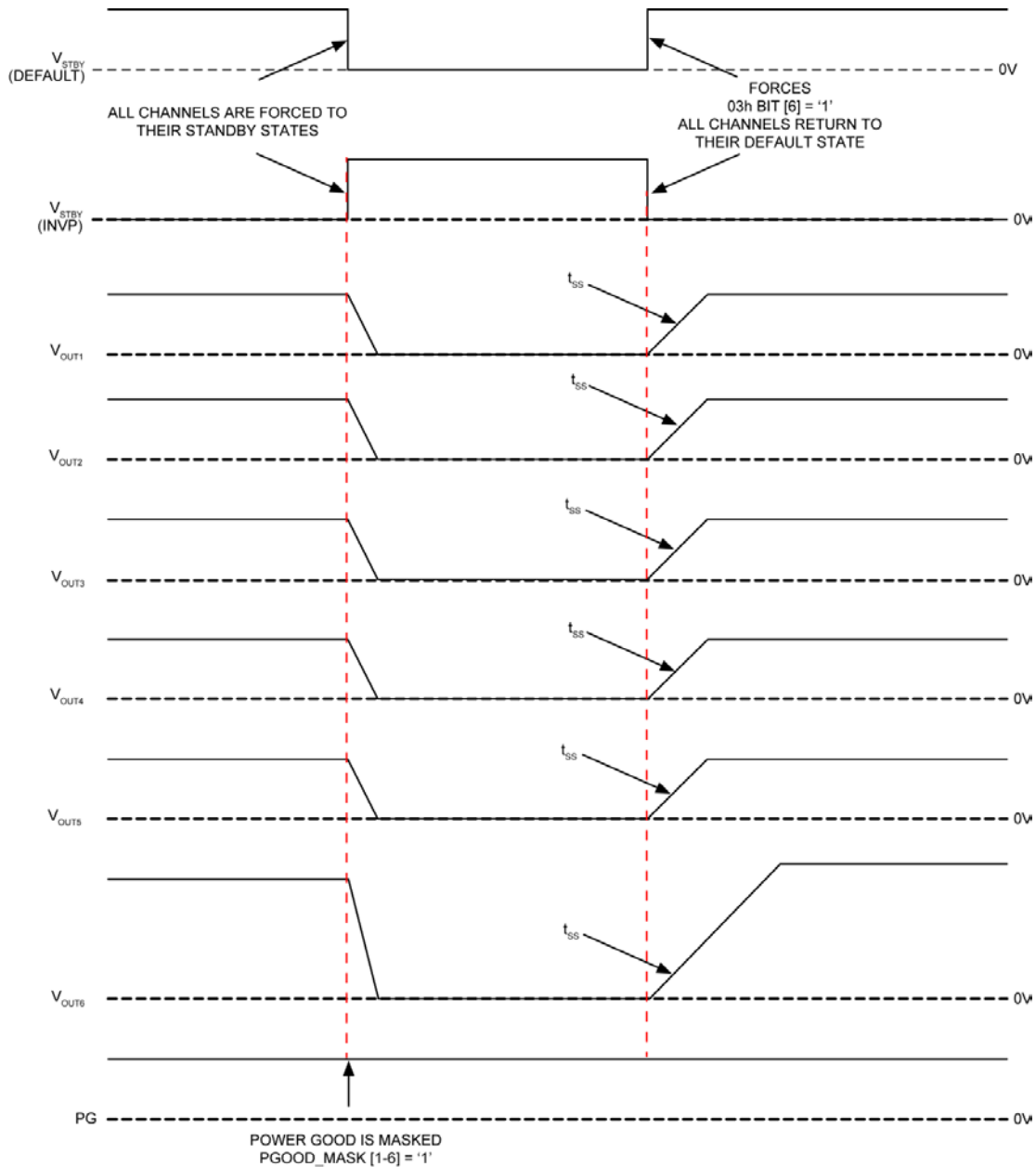
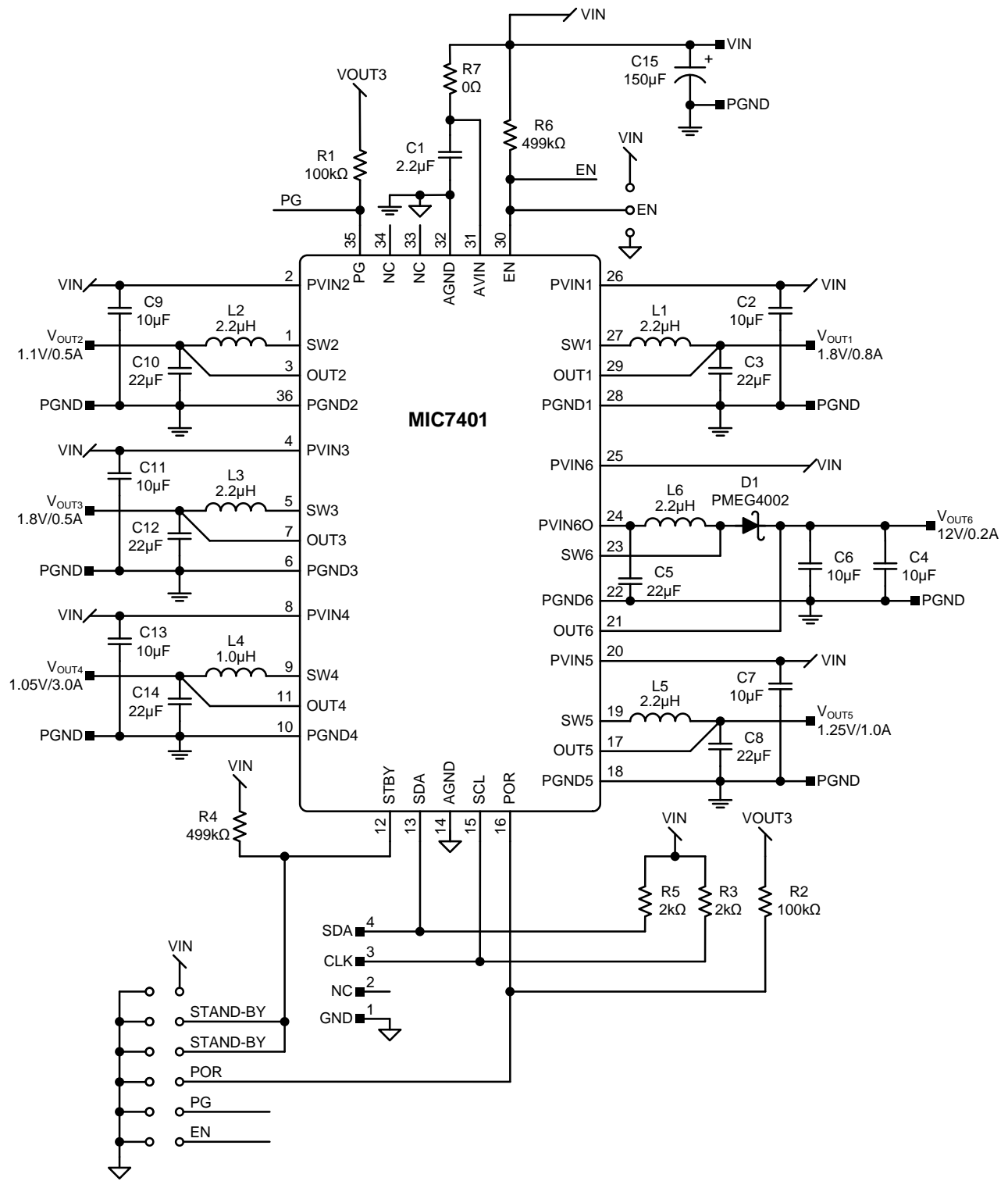

Figure 20. MIC7401 STBY Function (DEFAULT)

# Evaluation Board Schematic



**Bill of Materials**

Item	Part Number	Manufacturer	Description	Qty.
C1	CL05A225KO5NQNC	Samsung <sup>(14)</sup>	2.2μF/16V, Ceramic, X5R, 0402, 0.8mm, ±10%	1
C2, C7, C9, C11, C13	CL10A106MO8NQNC	Samsung	10μF/16V, Ceramic, X5R, 0603, 0.8mm, ±20%	5
C4, C6	CL21A106KAYNNNE	Samsung	10μF/25V, Ceramic, X5R, 0805, 1.25mm, ±20%	2
C3, C5, C8, C10, C12, C14	CL10A226MQ8NUNE	Samsung	22μF/6.3V, Ceramic, X5R, 0603, 0.8mm, ±20%	6
C15	EEF-CX0J151XR	Panasonic	150μF/6.3V, POS Capacitor, SP, ±20%	1
D1	PMEG4002EL	NXP <sup>(15)</sup>	0.2A/40V, Schottky, SOD-882	1
R1, R2	RC1005F104CS	Samsung	100kΩ, Resistor, 0402, 1%	3
R3, R5	RC1005F202CS	Samsung	2.0kΩ, Resistor, 0402, 1%	2
R4, R6	RC1005F4993CS	Samsung	499kΩ, Resistor, 0402, 1%	1
R7	RC1005J000CS	Samsung	0.00Ω, Resistor, 0402, Jumper	1
L1, L2, L3, L5, L6	CIG22H2R2MNE	Samsung	2.2μH, 1.6A Inductor, 116mΩ, 2520 × 1.2mm (maximum)	5
L4	CIGW252010GM1R0MNE	Samsung	1.0μH, 3.3A Inductor, 40mΩ, 2520 × 1.0mm (maximum)	1
U1	MIC7401YFL	Micrel <sup>(16)</sup>	<b>Five-Channel Buck Regulator Plus One Boost with HyperLight Load and I<sup>2</sup>C Control</b>	1

**Notes:**14. Samsung: [www.samsung.com](http://www.samsung.com).15. NXP: [www.nxp.com](http://www.nxp.com).16. Micrel, Inc.: [www.micrel.com](http://www.micrel.com).

## PCB Layout Guidelines

**Warning!!! To minimize EMI and output noise, follow these layout recommendations.**

PCB Layout is critical to achieve reliable, stable and efficient performance. A ground plane is required to control EMI and minimize the inductance in power, signal and return paths.

The following guidelines should be followed to insure proper operation:

### General

- Most of the heat removed from the IC is due to the exposed pad (EP) on the bottom of the IC conducting heat into the internal ground planes and the ground plane on the bottom side of the board. Use at least 16 vias for the EP to ground plane connection.
- Do not connect the PGND and AGND traces together on the top layer. The single point connection is made on the layer 2 ground plane.
- Do not put a via directly in front of a high current pin, SW, PGND, or PVIN. This will increase the trace resistance and parasitic inductance.
- Do not place a via in between the input and output capacitor ground connection. Put it to the inside of the output capacitor and in the way of the high di/dt current path.
- Route all power traces on the top layer, as shown in the example layout.
- Place the input capacitors first and put them as close as possible to the IC.

### IC

- The 2.2 $\mu$ F ceramic capacitor, which is connected to the AVIN pin, must be located right at the IC. The AVIN pin is very noise sensitive and placement of the capacitor is very critical. Use wide traces to connect to the AVIN and AGND pins.
- The analog ground pin (AGND) must be connected directly to the ground planes. Do not route the SGND pin to the PGND Pad on the top layer.
- Use fat traces to route the input and output power lines.
- Use Layer 5 as an input voltage power plane.
- Layer 2 and the bottom layer (Layer 6) are ground planes.

### Input Capacitor

- A 10 $\mu$ F X5R or X7R dielectrics ceramic capacitor is recommended on each of the PVIN pins for bypassing.
- Place the input capacitors on the same side of the board and as close to the IC as possible.
- Keep both the PVIN pin and PGND connections short.
- If possible, place vias to the ground plane close to the each input capacitor ground terminal, but not in the way of the high di/dt current path.
- Use either X7R or X5R dielectric input capacitors. Do not use Y5V or Z5U type capacitors.
- Do not replace the ceramic input capacitor with any other type of capacitor. Any type of capacitor can be placed in parallel with the input capacitor.
- In "Hot-Plug" applications, a Tantalum or Electrolytic bypass capacitor must be used to limit the over-voltage spike seen on the input supply when power is suddenly applied.

### Inductor

- Keep the inductor connection to the switch node (SW) short.
- Do not route any digital lines underneath or close to the inductor.
- To minimize noise, place a ground plane underneath the inductor.

### Output Capacitor

- Use a wide trace to connect the output capacitor ground terminal to the input capacitor ground terminal. In the example layout, all input and output capacitor ground connections are place back-to-back.
- The OUT[1-6] trace should be separate from the power trace and connected as close as possible to the output capacitor. Sensing a long high-current load trace can degrade the DC load regulation.

### Proper Termination of Unused Pins

Many designs will not require all six DC-to-DC output voltages. In these cases, the unused pin must be connected to either  $V_{IN}$  or GND.

The schematic in [Figure 21](#) shows where to tie the unused pins and [Table 4](#) summarizes the connections.

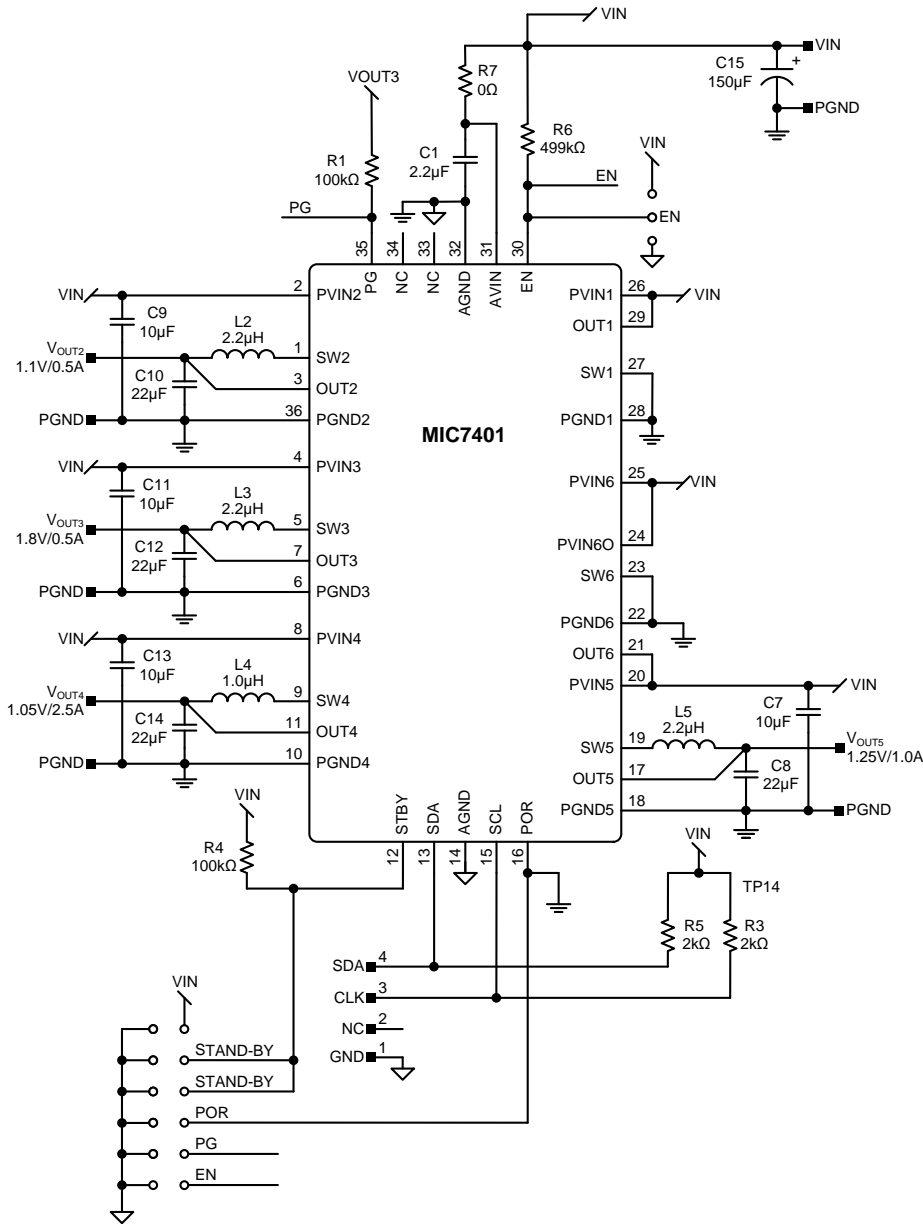

Figure 21. Connections for Unused Pins

Table 4. Summarization of Unused Pin Connections

Unused	VIN	PGND
Boost	PVIN6, PGIN6O, VOUT6	PGND6, SW6
Buck	PVIN[x], VOUT[x]	PGND[6], SW[x]
POR		POR



### PCB Layout Recommendations

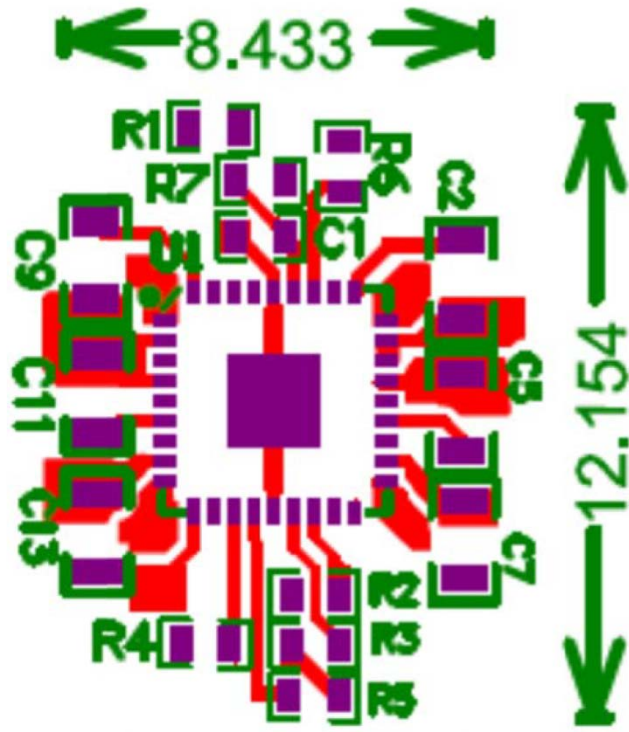

Evaluation Board Top Layer – Power Component Placement

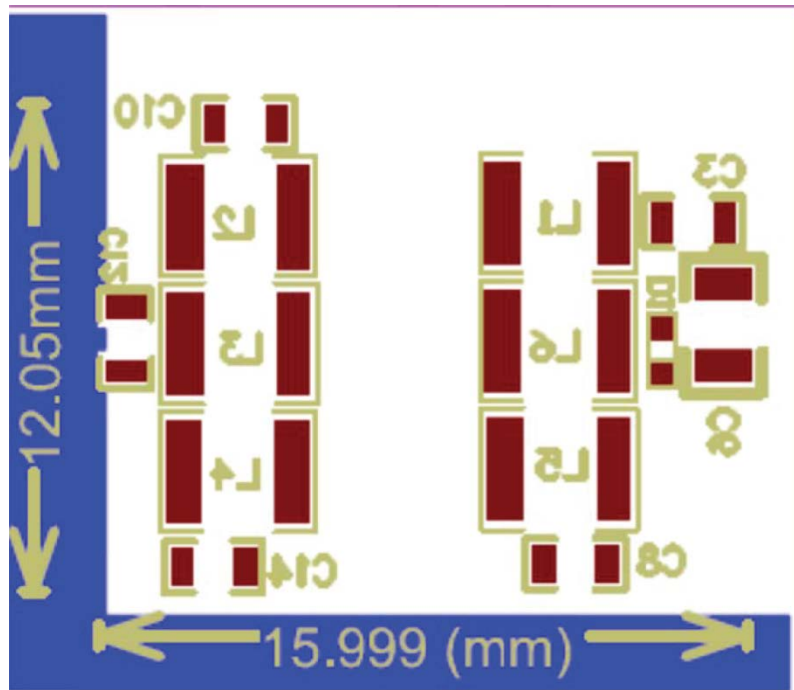

Evaluation Board Bottom Layer – Layer 6 (Power Routing Layer)

### PCB Layout Recommendations (Continued)

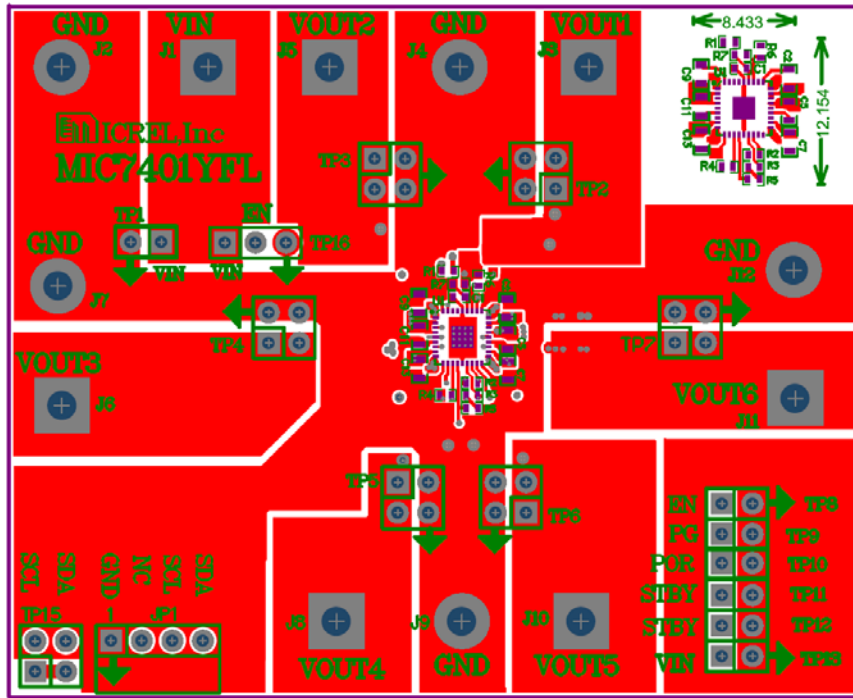

Evaluation Board Top Layer – Layer 1 (Power Routing Layer)

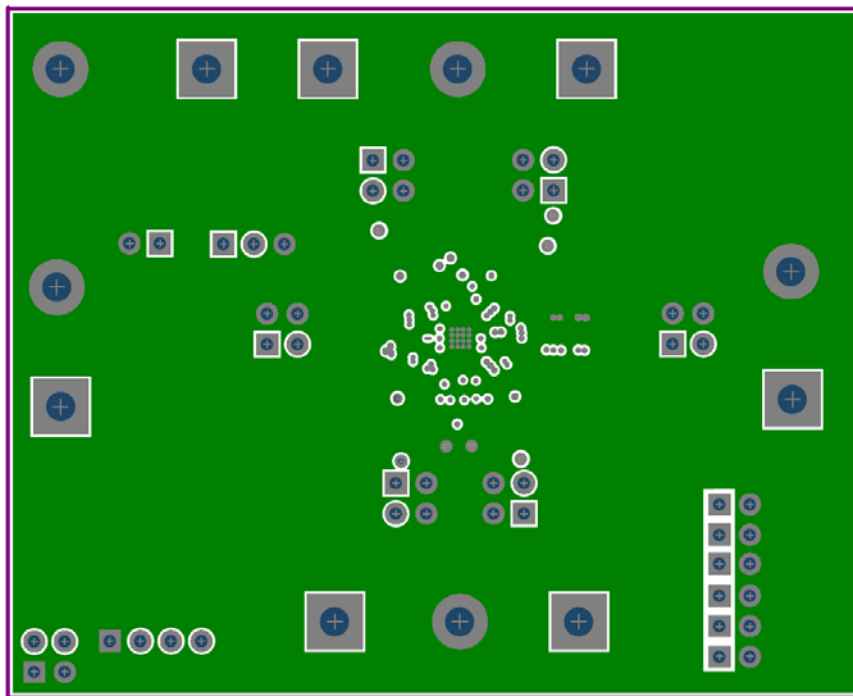

Evaluation Board Layer 2 (Ground Plane)

## PCB Layout Recommendations (Continued)

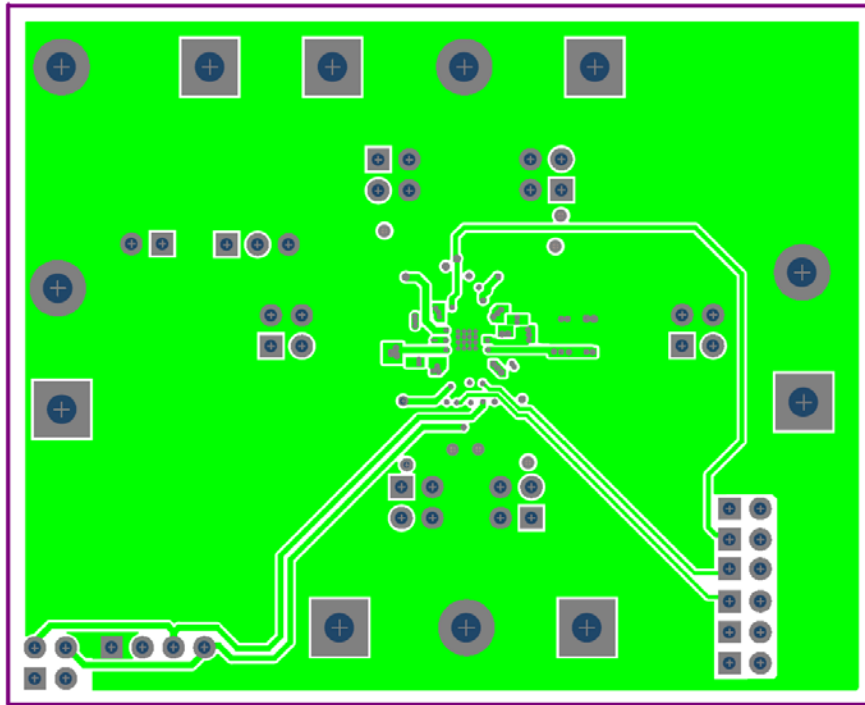

Evaluation Board Top Layer – Layer 3 (Signal Routing Layer)

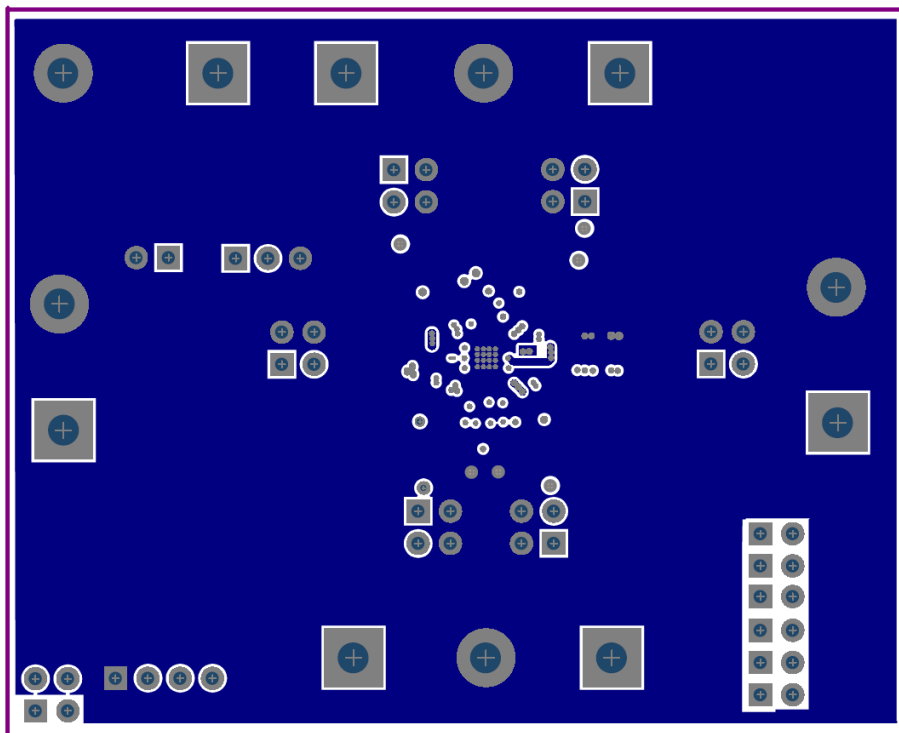

Evaluation Board Layer 4 (Ground Plane)

### PCB Layout Recommendations (Continued)

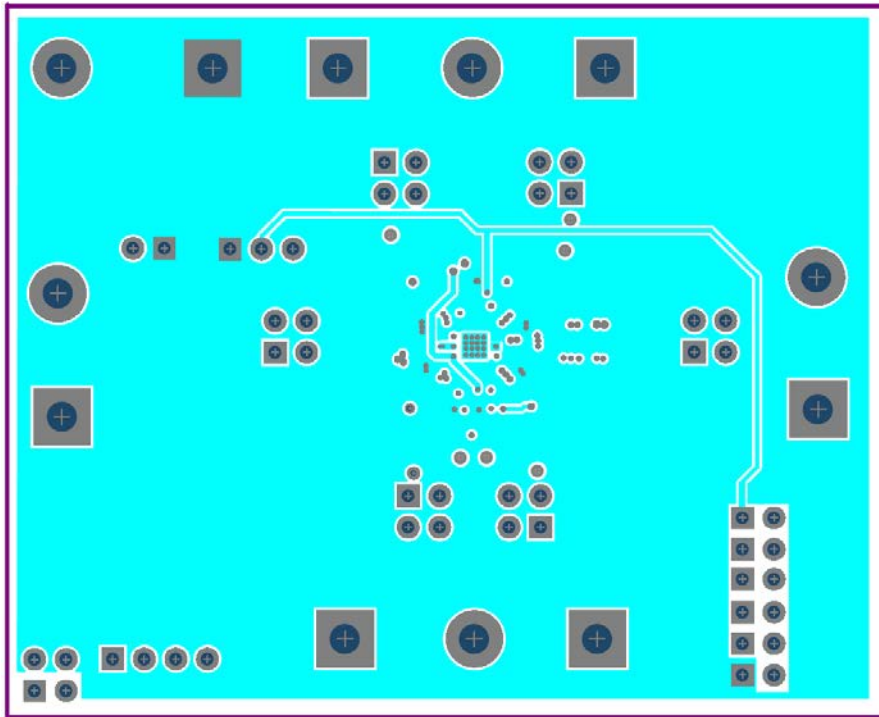

Evaluation Board Layer – Layer 5 (VIN Plane)

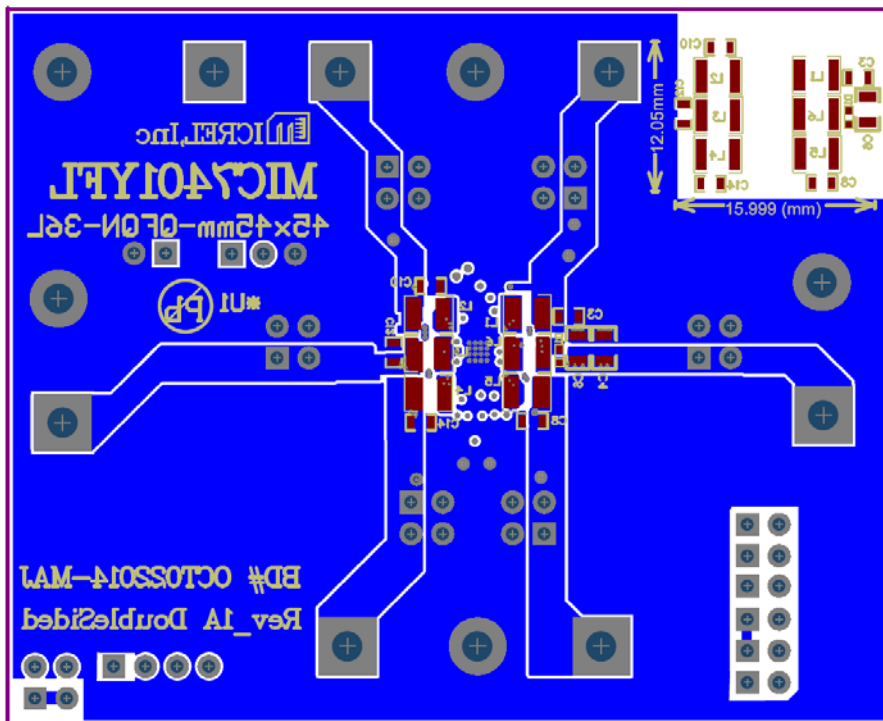

Evaluation Board Bottom Later – Layer 6 (Ground Plane)

## Package Information<sup>(17)</sup> and Recommended Landing Pattern

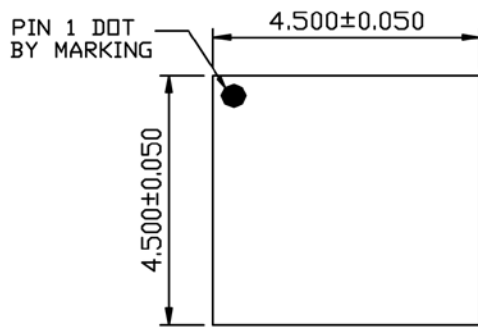

**TOP VIEW**  
NOTE: 1, 2, 3

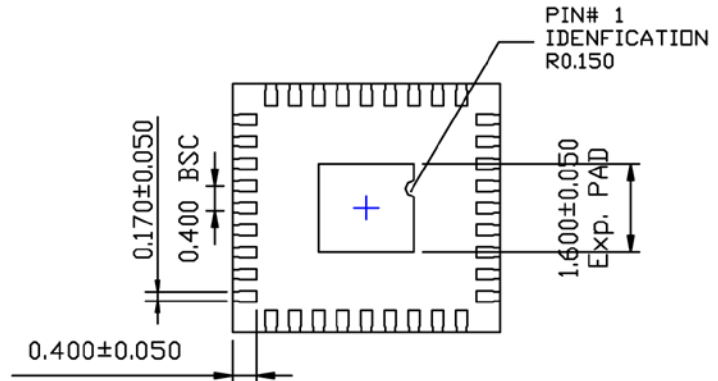

**BOTTOM VIEW**  
NOTE: 1, 2, 3

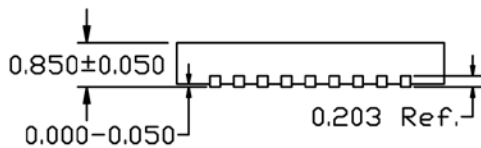

**SIDE VIEW**  
NOTE: 1, 2, 3

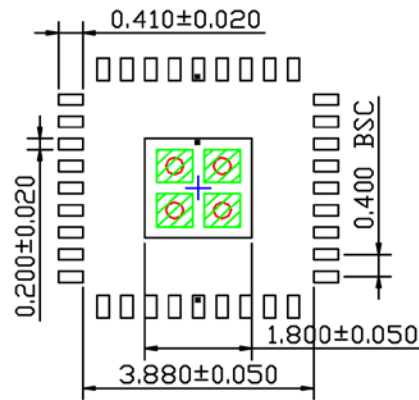

**RECOMMENDED LAND PATTERN**  
NOTE: 4, 5, 6

**NOTE:**

1. MAX PACKAGE WARPAGE IS 0.05 MM
2. MAX ALLOWABLE BURR IS 0.076MM IN ALL DIRECTIONS
3. PIN #1 IS ON TOP WILL BE LASER MARKED
4. RED CIRCLE IN LAND PATTERN REPRESENT THERMAL VIA. SIZE SHOULD BE 0.30-0.35MM IN DIAMETER, 0.8MM PITCH & MUST BE CONNECTED TO GND FOR MAX THERMAL PERFORMANCE
5. GREEN RECTANGLES (SHADED AREA, OPTIONAL) REPRESENT SOLDER STENCIL OPENING ON EXPOSED PAD AREA. SIZE SHOULD BE 0.60X0.60 MM IN SIZE, 0.20MM SPACING.
6. LAND PATTERN OPENINGS MARKED BY "\*" (PINS#14, 32 & EPAD) ARE OF SAME GND AND SHOULD BE CONNECTED ON BOARD LEVEL FOR MAXIMUM THERMAL PERFORMANCE

**36-Pin 4.5mm x 4.5mm QFN (FL)**

**Note:**

17. Package information is correct as of the publication date. For updates and most current information, go to [www.micrel.com](http://www.micrel.com).

### Via Layout Design and Layout Constraints

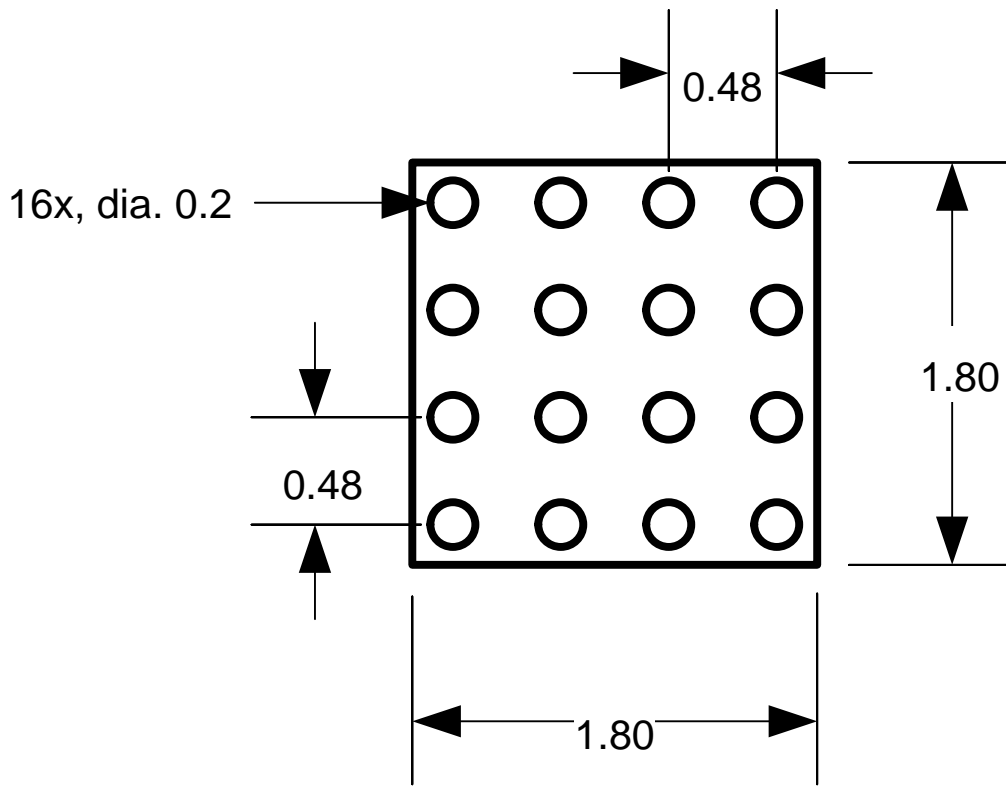

Via Layout Design

**Notes:**

Dimensions in millimeters (mm).

This package is designed to be soldered to a thermal pad on the board. Connect all ground planes together

Customers should contact their board fabrication site for recommended solder mask tolerance and via tenting recommendations for vias placed in the thermal pad.

## Appendix A

### I<sup>2</sup>C Control Register

The MIC7401 I<sup>2</sup>C Read/Write registers are detailed here. During normal operation, the configuration data can be saved into non-volatile registers in EEPROM by addressing the chip and writing to SAVECONFIG key = 66'h. Saving CONFIG data to EEPROM takes time so the external host should poll the MIC7401 and read the CONFIG Bit[1] of EEPROM Ready register 01'h to determine the end of programming.

All transactions start with a control byte sent from the I<sup>2</sup>C master device. The control byte begins with a START condition, followed by a 7-bit slave address. The slave address is seven bits long followed by an eighth bit which is a data direction bit (R/W), a '0' indicates a transmission (WRITE) and a '1' indicates a request for data (READ). A data transfer is always terminated by a STOP condition that is generated by the master.

### Serial Port Operation

#### External Host Interface

Bidirectional I<sup>2</sup>C port capable of Standard (up to 100kbits/s), Fast (up to 400kbits/s), Fast Plus (up to 1Mbit/s) and High Speed (up to 3.4Mbit/s) as defined in the I<sup>2</sup>C-Bus Specification.

The MIC7401 acts as an I<sup>2</sup>C slave when addressed by the external host. The MIC7401 slave address uses a fixed 7-bit code and is followed by an R/W bit which is part of the control word that is right after the start bit as shown in Figure 22 in the Device Address column.

The MIC7401 can receive multiple data bytes after a single address byte and automatically increments its register pointer to block fill internal volatile memory. Byte data is latched after individual bytes are received so multi-byte transfers could be corrupted if interrupted mid-stream.

No system clock is required by the digital core for I<sup>2</sup>C access from the external host (only the host SCL clock is assumed).

In order to prevent spurious operation of the I<sup>2</sup>C, if a start bit is seen, then any partial communication is aborted and new I<sup>2</sup>C data is allowed. Start bit is when SDA goes low when SCL is high. Stop bit is when SDA goes high when SCL is high. Normal I<sup>2</sup>C exchange is shown in Figure 22.

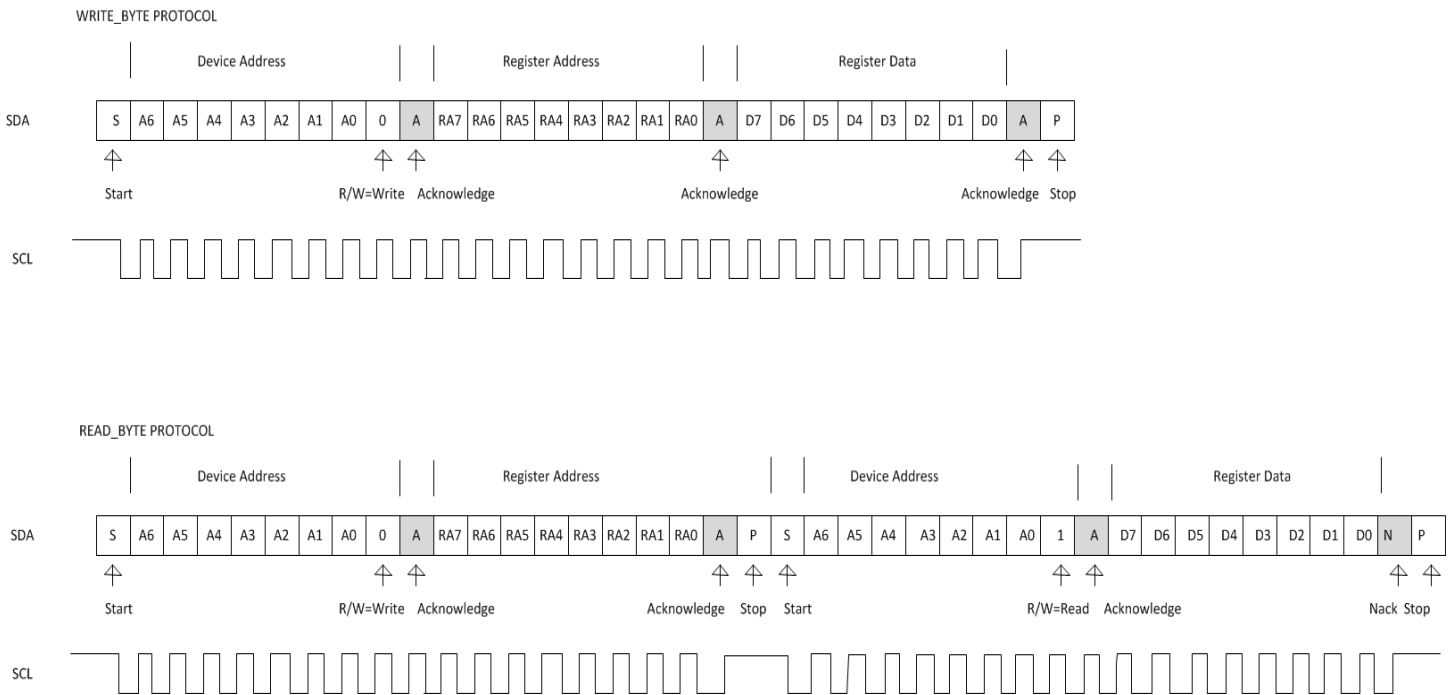

Figure 22. Read/Write Protocol

**Special Host I<sup>2</sup>C Commands**

The following commands are all 2 byte communications:

Byte1 = device address with write bit set, LSB = 0

Byte2 = special key

**Special Keys**

- **SAVECONFIG Key = 66'h.** Saves the shadow register configuration data into EEPROM registers 03'h thru 23'h.
- **RESET Key = 6A'h.** Reloads only NORMAL mode voltage and current limit settings then enables the regulator to NORMAL mode with no soft-start, no sequencing, and no delays. Then clears the STANDBY register bit 6 in register 03'h.
- **RELOAD Key = 6B'h.** Reloads all data from EEPROM into the shadow registers. No other actions are performed, including soft-start, sequencing, and delay.
- **REBOOT Key = 6C'h.** Turns all regulators OFF, reloads EEPROM data into shadow registers, and then re-sequences the regulators with the programmed soft-start and sequence delays.
- **SEQUENCE Key = 6D'h.** Turns all regulators OFF, restarts the sequencer including soft-start and sequence delays.



## Appendix B

### Register Settings Descriptions

#### Power Good Register (00'h)

This register indicates when the regulators 1 – 6 output voltage is above 91% of the target value. The MIC7401 deglitches the input signal for 50 $\mu$ s in order to prevent false events. The global PG pin indicator is functional 'AND' of all the power good indicators during sequencing. Once the power-up sequence is complete, the global power good output stays high unless an output falls below its power-good limit, a thermal fault occurs, the input voltage drops below the lower UVLO threshold or an output is turned OFF by setting the enable register bit to "0" if the PGOOD\_MASK[x] bit is set to "0".

**Table 5. Power Good Status Register**

Register Name	PGOOD1-6_REG			Power Good Status Register	
Address				0x00'h	
Field	bit	R/W	Default	Description	
PGOOD1	0	R	0	Power Good Indicator for Regulator 1	
				0 = Buck Not Valid	1 = Buck Valid
PGOOD2	1	R	0	Power Good Indicator for Regulator 2	
				0 = Buck Not Valid	1 = Buck Valid
PGOOD3	2	R	0	Power Good Indicator for regulator 3	
				0 = Buck Not Valid	1 = Buck Valid
PGOOD4	3	R	0	Power Good Indicator for Regulator 4	
				0 = Buck Not Valid	1 = Buck Valid
PGOOD5	4	R	0	Power Good Indicator for Regulator 5	
				0 = Buck Not Valid	1 = Buck Valid
PGOOD6	5	R	0	Power Good Indicator for Regulator 6	
				0 = Boost Not Valid	1 = Boost Valid
Reserved	6	R/W	0	Not Used	
Reserved	7	R/W	0	Not Used	

**EEPROM-Ready Register (01'h)**

This register indicates the status of EEPROM to external I<sup>2</sup>C host.

The READY bit = 1 when the Trim and Configuration data have been loaded into core from EEPROM after reset, reboot or reload and the chip is ready for operation. [If the SAVE1 bit in register 04'h is read in as logic 1, the configuration registers will not be loaded from the EEPROM memory and the READY bit will still get set indicating that any startup procedure involving the EEPROM memory is complete.] The READY bit will be set to 1 after loading or attempting to load Trim and Configuration data from EEPROM into volatile memory. The Trim data will always be loaded and if SAVE1 bit in register 04'h is set to logic 0, Configuration data is also loaded. Regardless of the SAVE1 bit being set or not, after the loading operation the READY bit is set to 1.

The CONFIG bit = 1 when the Configuration data have been saved to EEPROM after the SAVECONFIG Code is issued from the Host. If CONFIG=1 before the SAVECONFIG code is issued, CONFIG will be cleared immediately and then will be set to logic 1 again once all Configuration data is written to the EEPROM memory.

The CALIB bit = 1 when the Trim data have been saved to EEPROM after the SAVETRIM Code is issued from the Host. If CALIB=1 before the SAVETRIM code is issued, CALIB will be cleared immediately and then will be set to logic 1 again once all Trim data is written to the EEPROM memory.

The EEPREAD and EEPWRITE bits indicate if an EEPROM read or write fault has occurred. These bits should be read and cleared prior to reloading data from the EEPROM memory.

**Table 6. EEPROM Status Register**

Register Name	STATUS_REG			EEPROM Status Register
Address				0x01'h
Field	bit	R/W	Default	Description
READY	0	R	0	Indicate Ready for Operation when the Trim and Configuration Data has been Loaded
				0 = Data not loaded
CONFIG	1	R	0	Indicate Configuration saved to EEPROM
				0 = Configuration not saved
CALIB	2	R	0	Indicate Trim Data have been Saved to EEPROM
				0 = Trim not saved
Reserved	3	R/W	0	Not Used
Reserved	4	R/W	0	Not Used
Reserved	5	R/W	0	Not Used
EEPREAD	6	R/W	0	EEPROM Read
				0 = No Fault
EEPWRITE	7	R/W	0	EEPROM Write
				0 = No Fault

**Fault Registers (02'h)**

This register indicates the over-current flag for each regulator and one global overtemperature (OT). These register bits are set by an over current condition and reset by writing a logic 0 to each bit by the I<sup>2</sup>C host.

If the fault condition persists, the bit will be set to Logic 1 again immediately by the MIC7401 after it is written to logic 0 by the host.

**Table 7. Overcurrent Status Fault Register**

Register Name	FAULT_REG			Overcurrent Status Fault Register
Address				0x02'h
Field	bit	R/W	Default	Description
REG1OC	0	R/W	0	Regulator 1 Overcurrent
				0 = No Fault
REG2OC	1	R/W	0	Regulator 2 Overcurrent
				0 = No Fault
REG3OC	2	R/W	0	Regulator 3 Overcurrent
				0 = No Fault
REG4OC	3	R/W	0	Regulator 4 Overcurrent
				0 = No Fault
REG5OC	4	R/W	0	Regulator 5 Overcurrent
				0 = No Fault
REG6OC	5	R/W	0	Regulator 6 Overcurrent
				0 = No Fault
Reserved	6	R/W	0	Reserved
OT	7	R/W	0	Overtemperature
				0 = No Fault

**Standby Register (03'h)**

This register controls standby mode operation. Global stand-by mode can either be enabled by I<sup>2</sup>C or by changing the logic state of the STBY input pin. Global stand-by is controlled by the STBY\_MODEB bit. When STBY\_MODEB [6] = 1 then the regulators output voltages are set to their normal-mode output voltage settings, (05'h – 0A'h) registers. When STBY\_MODEB [6] = 0 then regulators output voltages are set to the standby-mode output voltage settings, (0B'h – 10'h) registers. If STBY [1-6] register is set to logic "0", then the output is shut off in standby mode.

The global power-good flag is asserted when an output is disabled unless the power-good mask bit (PGOOD\_MASK[x]) is set to 1.

**Table 8. Standby Register**

Register Name	STBY_CTRL_REG			Standby Register
Address				0x03'h
Field	bit	R/W	Default	Description
STBY1	0	R/W	1	Regulator 1 Standby Voltage Control
				0 = OFF
STBY2	1	R/W	1	Regulator 2 Standby Voltage Control
				0 = OFF
STBY3	2	R/W	1	Regulator 3 Standby Voltage Control
				0 = OFF
STBY4	3	R/W	1	Regulator 4 Standby Voltage Control
				0 = OFF
STBY5	4	R/W	1	Regulator 5 Standby Voltage Control
				0 = OFF
STBY6	5	R/W	1	Regulator 6 Standby Voltage Control
				0 = OFF
STBY_MODEB	6	R/W	1	Global Standby Control
				0 = All regulators in Standby Mode
				1 = All regulators in Normal Mode
Reserved	7	R/W	0	Not Used

**Enable/Disable Register (04'h)**

This register controls the enable/disable of each DC-to-DC regulators. When EN(n) bit transitions from 0 to 1 then the regulator(n) is enabled with Soft-Start unless the STBY\_MODEB register bit in register 03'h is set to logic 0.

The configuration save bit "SAVE1" should be cleared by customer before saving configuration data to EEPROM. This bit is used during power-up to indicate via the Status register (00'h) that configuration data has previously been stored.

**Table 9. Enable Register**

Register Name	EN_REG			Enable Register
Address				0x04'h
Field	bit	R/W	Default	Description
EN1	0	R/W	1	Regulator 1 ON/OFF Control bit
				0 = OFF
EN2	1	R/W	1	Regulator 2 ON/OFF Control bit
				0 = OFF
EN3	2	R/W	1	Regulator 3 ON/OFF Control
				0 = OFF
EN4	3	R/W	1	Regulator 4 ON/OFF Control
				0 = OFF
EN5	4	R/W	1	Regulator 5 ON/OFF Control
				0 = OFF
EN6	5	R/W	1	Regulator 6 ON/OFF Control
				0 = OFF
Reserved	6	R/W	0	Not Used
SAVE1	7	R/W	0	Save Configuration
				0 = Configuration Saved to EEPROM
				1 = Not Configuration Saved to EEPROM

**Regulator Output Voltage Setting NORMAL Mode (05'h – 09'h)**

One register for each regulator output (OUT1 – OUT5). Sets output voltage of regulator for NORMAL mode operation.

**Table 10. DVC Registers for OUT[1 – 5]**

Register Name	OUT1-5_REG			DVC Registers for OUT[1-5]			
Address				OUT1 = 0x05'h OUT2 = 0x06'h OUT3 = 0x07'h OUT4 = 0x08'h OUT5 = 0x09'h			
Field	bit	R/W	Default	Description			
OUT[1-5]	5:0	R/W	See <a href="#">Table 2</a>	Output Voltage Setting of OUT[1-5], DVC from 3.3 V to 0.8V in -50mV Steps			
				000000 = 3.30V	010000 = 2.50V	100000 = 1.70V	110000 = 0.90V
				000001 = 3.25V	010001 = 2.45V	100001 = 1.65V	110001 = 0.85V
				000010 = 3.20V	010010 = 2.40V	100010 = 1.60V	110010 = 0.80V
				000011 = 3.15V	010011 = 2.35V	100011 = 1.55V	110011 = 0.80V
				000100 = 3.10V	010100 = 2.30V	100100 = 1.50V	110100 = 0.80V
				000101 = 3.05V	010101 = 2.25V	100101 = 1.45V	110101 = 0.80V
				000110 = 3.00V	010110 = 2.20V	100110 = 1.40V	110110 = 0.80V
				000111 = 2.95V	010111 = 2.15V	100111 = 1.35V	110111 = 0.80V
				001000 = 2.90V	011000 = 2.10V	101000 = 1.30V	111000 = 0.80V
				001001 = 2.85V	011001 = 2.05V	101001 = 1.25V	111001 = 0.80V
				001010 = 2.80V	011010 = 2.00V	101010 = 1.20V	111010 = 0.80V
				001011 = 2.75V	011011 = 1.95V	101011 = 1.15V	111011 = 0.80V
				001100 = 2.70V	011100 = 1.90V	101100 = 1.10V	111100 = 0.80V
				001101 = 2.65V	011101 = 1.85V	101101 = 1.05V	111101 = 0.80V
				001110 = 2.60V	011110 = 1.80V	101110 = 1.00V	111110 = 0.80V
				001111 = 2.55V	011111 = 1.75V	101111 = 0.95V	111111 = 0.80V
	6		0	Not Used			
	7		0	Not Used			

**Boost Regulator Output Voltage Setting NORMAL Mode (0A'h)**

Sets output voltage of the boost regulator (OUT6) in NORMAL mode operation.

**Table 11. DVC Registers for OUT6**

Register Name	OUT6_REG			DVC Registers			
Address	0x0A'h						
Field	bit	R/W	Default	Description			
OUT6	5:0	R/W	See <a href="#">Table 2</a>	DVC from 14V to 7V in 200mV Decrements			
				000000 = 14.0V	010000 = 10.8V	100000 = 7.6V	110000 = 7.0V
				000001 = 13.8V	010001 = 10.6V	100001 = 7.4V	110001 = 7.0V
				000010 = 13.6V	010010 = 10.4V	100010 = 7.2V	110010 = 7.0V
				000011 = 13.4V	010011 = 10.2V	100011 = 7.0V	110011 = 7.0V
				000100 = 13.2V	010100 = 10.0V	100100 = 7.0V	110100 = 7.0V
				000101 = 13.0V	010101 = 9.8V	100101 = 7.0V	110101 = 7.0V
				000110 = 12.8V	010110 = 9.6V	100110 = 7.0V	110110 = 7.0V
				000111 = 12.6V	010111 = 9.4V	100111 = 7.0V	110111 = 7.0V
				001000 = 12.4V	011000 = 9.2V	101000 = 7.0V	111000 = 7.0V
				001001 = 12.2V	011001 = 9.0V	101001 = 7.0V	111001 = 7.0V
				001010 = 12.0V	011010 = 8.8V	101010 = 7.0V	111010 = 7.0V
				001011 = 11.8V	011011 = 8.6V	101011 = 7.0V	111011 = 7.0V
				001100 = 11.6V	011100 = 8.4V	101100 = 7.0V	111100 = 7.0V
				001101 = 11.4V	011101 = 8.2V	101101 = 7.0V	111101 = 7.0V
				001110 = 11.2V	011110 = 8.0V	101110 = 7.0V	111110 = 7.0V
				001111 = 11.0V	011111 = 7.8V	101111 = 7.0V	111111 = 7.0V
	6		0	Not Used			
	7		0	Not Used			

**Regulator Voltage Setting STBY Mode (0B'h – 0F'h)**

This register is used to sets the output voltage of regulators 1 – 5 in STBY mode operation.

**Table 12. Standby Registers**

Register Name	STBY_OUT1-5_REG			Standby DVC Registers			
Address				OUT1 = 0x0B'h OUT2 = 0x0C'h OUT3 = 0x0D'h OUT4 = 0x0E'h OUT5 = 0x0F'h			
Field	bit	R/W	Default	Description			
SB_OUT[1-5]	5:0	R/W	See <a href="#">Table 2</a>	Output Voltage Setting of OUT[1-5], DVC from 3.3V to 0.8V in –50mV Steps			
				000000 = 3.30V	010000 = 2.50V	100000 = 1.70V	110000 = 0.90V
				000001 = 3.25V	010001 = 2.45V	100001 = 1.65V	110001 = 0.85V
				000010 = 3.20V	010010 = 2.40V	100010 = 1.60V	110010 = 0.80V
				000011 = 3.15V	010011 = 2.35V	100011 = 1.55V	110011 = 0.80V
				000100 = 3.10V	010100 = 2.30V	100100 = 1.50V	110100 = 0.80V
				000101 = 3.05V	010101 = 2.25V	100101 = 1.45V	110101 = 0.80V
				000110 = 3.00V	010110 = 2.20V	100110 = 1.40V	110110 = 0.80V
				000111 = 2.95V	010111 = 2.15V	100111 = 1.35V	110111 = 0.80V
				001000 = 2.90V	011000 = 2.10V	101000 = 1.30V	111000 = 0.80V
				001001 = 2.85V	011001 = 2.05V	101001 = 1.25V	111001 = 0.80V
				001010 = 2.80V	011010 = 2.00V	101010 = 1.20V	111010 = 0.80V
				001011 = 2.75V	011011 = 1.95V	101011 = 1.15V	111011 = 0.80V
				001100 = 2.70V	011100 = 1.90V	101100 = 1.10V	111100 = 0.80V
				001101 = 2.65V	011101 = 1.85V	101101 = 1.05V	111101 = 0.80V
				001110 = 2.60V	011110 = 1.80V	101110 = 1.00V	111110 = 0.80V
				001111 = 2.55V	011111 = 1.75V	101111 = 0.95V	111111 = 0.80V
	6		0	Not Used			
	7		0	Not Used			



**Boost Regulator Output Voltage Setting STBY Mode (10'h)**

Sets output voltage of the boost regulator (OUT6) for STBY mode operation.

**Table 13. Standby DVC Register for OUT6**

Register Name	STBY_OUT6_REG			DVC Registers			
Address				0x10'h			
Field	bit	R/W	Default	Description			
SB_OUT6	5:0	R/W	See <a href="#">Table 2</a>	DVC from 14V to 7V in 200mV decrements			
				000000 = 14.0V	010000 = 10.8V	100000 = 7.6V	110000 = 7.0V
				000001 = 13.8V	010001 = 10.6V	100001 = 7.4V	110001 = 7.0V
				000010 = 13.6V	010010 = 10.4V	100010 = 7.2V	110010 = 7.0V
				000011 = 13.4V	010011 = 10.2V	100011 = 7.0V	110011 = 7.0V
				000100 = 13.2V	010100 = 10.0V	100100 = 7.0V	110100 = 7.0V
				000101 = 13.0V	010101 = 9.8V	100101 = 7.0V	110101 = 7.0V
				000110 = 12.8V	010110 = 9.6V	100110 = 7.0V	110110 = 7.0V
				000111 = 12.6V	010111 = 9.4V	100111 = 7.0V	110111 = 7.0V
				001000 = 12.4V	011000 = 9.2V	101000 = 7.0V	111000 = 7.0V
				001001 = 12.2V	011001 = 9.0V	101001 = 7.0V	111001 = 7.0V
				001010 = 12.0V	011010 = 8.8V	101010 = 7.0V	111010 = 7.0V
				001011 = 11.8V	011011 = 8.6V	101011 = 7.0V	111011 = 7.0V
				001100 = 11.6V	011100 = 8.4V	101100 = 7.0V	111100 = 7.0V
				001101 = 11.4V	011101 = 8.2V	101101 = 7.0V	111101 = 7.0V
				001110 = 11.2V	011110 = 8.0V	101110 = 7.0V	111110 = 7.0V
				001111 = 11.0V	011111 = 7.8V	101111 = 7.0V	111111 = 7.0V
	6		0	Not Used			
	7		0	Not Used			

### Sequence Register (11'h)

Each regulator can be assigned to start in any one of six sequencing slots (1 to 6). If starting in slot 1, the regulator starts immediately. If starting in any other slot the regulator must wait for the PGOOD=1 flags of all regulators assigned to the preceding slot and then wait for the specified delay time (register 17'h) i.e., all PGOODs in preceding state flag then the delay timer is started and when delay completes the regulator is enabled.

Each regulator must delay its startup (after the appropriate preceding PGOOD flags) by the delay set in the Delay Register (17'h), unless the regulator is assigned to sequence state 0.

If all default Enable bits = 0 the IC starts up, but no outputs are enabled.

Sequencing is only used during initial startup, and not used when outputs are enabled via I<sup>2</sup>C command. If outputs are enabled via I<sup>2</sup>C then soft-start is still active but start-up delays (timed from preceding PGOODS) are not.

**Table 14. Sequence State 1 Register**

Register Name	SEQ1_REG			Sequence Register	
Address				0x11'h	
Field	bit	R/W	Default	Description	
REG1SQ1	0	R/W	0	0 = No Start	1 = Regulator 1 will Start in Sequence State 1
REG2SQ1	1	R/W	0	0 = No Start	1 = Regulator 2 will Start in Sequence State 1
REG3SQ1	2	R/W	0	0 = No Start	1 = Regulator 3 will Start in Sequence State 1
REG4SQ1	3	R/W	1	0 = No Start	1 = Regulator 4 will Start in Sequence State 1
REG5SQ1	4	R/W	0	0 = No Start	1 = Regulator 5 will Start in Sequence State 1
REG6SQ1	5	R/W	0	0 = No Start	1 = Regulator 6 will Start in Sequence State 1
	6	R/W	0	Reserved	
	7	R/W	0	Reserved	

**Table 15. Sequence State 2 Register**

Register Name	SEQ2_REG			Sequence Register	
Address				0x12'h	
Field	bit	R/W	Default	Description	
REG1SQ2	0	R/W	0	0 = No Start	1 = Regulator 1 will Start in Sequence State 2
REG2SQ2	1	R/W	1	0 = No Start	1 = Regulator 2 will Start in Sequence State 2
REG3SQ2	2	R/W	1	0 = No Start	1 = Regulator 3 will Start in Sequence State 2
REG4SQ2	3	R/W	0	0 = No Start	1 = Regulator 4 will Start in Sequence State 2
REG5SQ2	4	R/W	0	0 = No Start	1 = Regulator 5 will Start in Sequence State 2
REG6SQ2	5	R/W	0	0 = No Start	1 = Regulator 6 will Start in Sequence State 2
	6	R/W	0	Reserved	
	7	R/W	0	Reserved	

**Table 16. Sequence State 3 Register**

Register Name	SEQ3_REG			Sequence Register	
Address				0x13'h	
Field	bit	R/W	Default	Description	
REG1SQ3	0	R/W	1	0 = No Start	1 = Regulator 1 will Start in Sequence State 3
REG2SQ3	1	R/W	0	0 = No Start	1 = Regulator 2 will Start in Sequence State 3
REG3SQ3	2	R/W	0	0 = No Start	1 = Regulator 3 will Start in Sequence State 3
REG4SQ3	3	R/W	0	0 = No Start	1 = Regulator 4 will Start in Sequence State 3
REG5SQ3	4	R/W	0	0 = No Start	1 = Regulator 5 will Start in Sequence State 3
REG6SQ3	5	R/W	0	0 = No Start	1 = Regulator 6 will Start in Sequence State 3
	6	R/W	0	Reserved	
	7	R/W	0	Reserved	

**Table 17. Sequence State 4 Register**

Register Name	SEQ4_REG			Sequence Register	
Address				0x14'h	
Field	bit	R/W	Default	Description	
REG1SQ4	0	R/W	0	0 = No Start	1 = Regulator 1 will Start in Sequence State 4
REG2SQ4	1	R/W	0	0 = No Start	1 = Regulator 2 will Start in Sequence State 4
REG3SQ4	2	R/W	0	0 = No Start	1 = Regulator 3 will Start in Sequence State 4
REG4SQ4	3	R/W	0	0 = No Start	1 = Regulator 4 will Start in Sequence State 4
REG5SQ4	4	R/W	1	0 = No Start	1 = Regulator 5 will Start in Sequence State 4
REG6SQ4	5	R/W	0	0 = No Start	1 = Regulator 6 will Start in Sequence State 4
	6	R/W	0	Reserved	
	7	R/W	0	Reserved	

**Table 18. Sequence State 5 Register**

Register Name	SEQ5_REG			Sequence Register	
Address				0x15'h	
Field	bit	R/W	Default	Description	
REG1SQ5	0	R/W	0	0 = No Start	1 = Regulator 1 will Start in Sequence State 5
REG2SQ5	1	R/W	0	0 = No Start	1 = Regulator 2 will Start in Sequence State 5
REG3SQ5	2	R/W	0	0 = No Start	1 = Regulator 3 will Start in Sequence State 5
REG4SQ5	3	R/W	0	0 = No Start	1 = Regulator 4 will Start in Sequence State 5
REG5SQ5	4	R/W	0	0 = No Start	1 = Regulator 5 will Start in Sequence State 5
REG6SQ5	5	R/W	0	0 = No Start	1 = Regulator 6 will Start in Sequence State 5
	6	R/W	0	Reserved	
	7	R/W	0	Reserved	

**Table 19. Sequence State 6 Register**

Register Name	SEQ6_REG			Sequence Register	
Address				0x16'h	
Field	bit	R/W	Default	Description	
REG1SQ6	0	R/W	0	0 = No Start	1 = Regulator 1 will Start in Sequence State 6
REG2SQ6	1	R/W	0	0 = No Start	1 = Regulator 2 will Start in Sequence State 6
REG3SQ6	2	R/W	0	0 = No Start	1 = Regulator 3 will Start in Sequence State 6
REG4SQ6	3	R/W	0	0 = No Start	1 = Regulator 4 will Start in Sequence State 6
REG5SQ6	4	R/W	0	0 = No Start	1 = Regulator 5 will Start in Sequence State 6
REG6SQ6	5	R/W	1	0 = No Start	1 = Regulator 6 will Start in Sequence State 6
	6	R/W	0	Reserved	
	7	R/W	0	Reserved	

**Delay Register (17'h)**

The STDEL register sets the delay between powering up of each regulator at initial power-up (see [Figure 19](#)). Once all the internal power-good registers PGOOD[1-6] are all 1, then the global PG pin goes high without delay.

The PORDEL register sets the delay for the POR flag pin. The POR delay time starts as soon as AVIN pin voltage rises above the system UVLO upper threshold set by the PORUP register (21'h). The POR output goes low without delay if AVIN falls below the lower UVLO threshold set by the PORDN register (22'h).

**Table 20. Delay Register**

Register Name	DELAY_CNTL_REG			Delay Register			
Address				0x17'h			
Field	bit	R/W	Default	Description			
STDEL	2:0	R/W	001 (1ms)	Delay Time from 0ms to 7ms in 1ms Increments			
				000 = 0ms	010 = 2ms	100 = 4ms	110 = 6ms
				001 = 1ms	011 = 3ms	101 = 5ms	111 = 7ms
PORDEL	7:3	R/W	00011 (20ms)	Delay Time from 5ms to 160ms in 5ms Increments			
				00000 = 5ms	01000 = 45ms	10000 = 85ms	11000 = 125ms
				00001 = 10ms	01001 = 50ms	10001 = 90ms	11001 = 130ms
				00010 = 15ms	01010 = 55ms	10010 = 95ms	11010 = 135ms
				00011 = 20ms	01011 = 60ms	10011 = 100ms	11011 = 140ms
				00100 = 25ms	01100 = 65ms	10100 = 105ms	11100 = 145ms
				00101 = 30ms	01101 = 70ms	10101 = 110ms	11101 = 150ms
				00110 = 35ms	01110 = 75ms	10110 = 115ms	11110 = 155ms
				00111 = 40ms	01111 = 80ms	10111 = 120ms	11111 = 160ms

### Soft-Start Registers (18'h – 1A'h)

When regulator(n) is turned on from either the Enable Register (04'h) in NORMAL mode or from the Standby Register (03'h) in STANDBY mode, then the three REG(n)SS soft-start bits are used to control both the rising and falling ramp rate of the outputs.

In NORMAL mode, the outputs are stepped from the current regulator voltage settings to a newly-programmed regulator voltage setting or to the default value.

On power up, the regulator voltage output is set to the lowest possible voltage setting which is 3F'h. The voltage regulator will change by one step or increment at a time. The amount of time between each step is controlled by the soft-start registers. [Table 21](#) details the amount of time for each encoded soft-start value.

**Table 21. Soft-Start Register Speed Settings**

	R/W	Default	Description			
SS_SPEED = 0	R/W	000	Soft-Start Time from 4 $\mu$ s to 512 $\mu$ s			
			000 = 4 $\mu$ s	010 = 16 $\mu$ s	100 = 64 $\mu$ s	110 = 256 $\mu$ s
			001 = 8 $\mu$ s	011 = 32 $\mu$ s	101 = 128 $\mu$ s	111 = 512 $\mu$ s
SS_SPEED = 1	R/W	000	Soft-Start Time from 8 $\mu$ s to 1024 $\mu$ s			
			000 = 8 $\mu$ s	010 = 32 $\mu$ s	100 = 128 $\mu$ s	110 = 512 $\mu$ s
			001 = 16 $\mu$ s	011 = 64 $\mu$ s	101 = 256 $\mu$ s	111 = 1024 $\mu$ s

**Table 22. Soft-Start Register OUT1 and OUT2**

Register Name	SS1-2_REG			Soft-Start Register for V <sub>OUT1</sub> and V <sub>OUT2</sub>
Address				0x18'h
Field	bit	R/W	Default	Description
REG1SS	2:0	R/W	001 (8 $\mu$ s)	OUT1 Soft-Start Time
				See <a href="#">Table 19</a> for Soft-Start Settings
REG2SS	5:3	R/W	001 (8 $\mu$ s)	OUT2 Soft-Start Time
				See <a href="#">Table 19</a> for Soft-Start Settings
	6	R/W	0	Reserved
SS_SPEED	7	R/W	0	Set the speed of the clock to slow or fast for different clock division, see <a href="#">Table 19</a> .
				0 = Slow Speed

**Table 23. Soft-Start Register OUT3 and OUT4**

Register Name	SS3-4_REG			Soft-Start Register for V <sub>OUT3</sub> and V <sub>OUT4</sub>
Address				0x19'h
Field	bit	R/W	Default	Description
REG3SS	2:0	R/W	001 (8 $\mu$ s)	OUT3 Soft-Start Time
				See <a href="#">Table 19</a> for Soft-Start Settings
REG4SS	5:3	R/W	001 (8 $\mu$ s)	OUT4 Soft-Start Time
				See <a href="#">Table 19</a> for Soft-Start Settings
	6	R/W	0	Reserved
	7	R/W	0	Reserved

**Table 24. Soft-Start Register OUT5 and OUT6**

Register Name	SS5-6_REG			Soft-Start Register for V <sub>OUT5</sub> and V <sub>OUT6</sub>
Address				0x1A'h
Field	bit	R/W	Default	Description
REG5SS	2:0	R/W	001 (8μs)	OUT5 Soft-Start Time
				See <a href="#">Table 19</a> for Soft-Start Settings
REG6SS	5:3	R/W	010 (16μs)	OUT6 Soft-Start Time
				See <a href="#">Table 19</a> for Soft-Start Settings
	6	R/W	0	Reserved
	7	R/W	0	Reserved

**Current-Limit (Normal Mode) Registers (1B'h – 1D'h)**

This register is use to set the current limit for each DC-to-DC regulator in normal mode operation.

**Table 25. Current-Limit Register I<sub>OUT1</sub> and I<sub>OUT2</sub>**

Register Name	ILIMIT_1-2_REG			Current-Limit Register for V <sub>OUT1</sub> and V <sub>OUT2</sub>
Address				0x1B'h
Field	bit	R/W	Default	Description
REG1CL	3:0	R/W	1000 (4.1A)	Normal Current-Limit for Regulator 1 from 8.1A to 0.6A in 0.5A Decrements
				0000 = 8.6A    0100 = 6.6A    1000 = 4.6A    1100 = 2.6 A
				0001 = 8.1A    0101 = 6.1A    1001 = 4.1A    1101 = 2.1A
				0010 = 7.6A    0110 = 5.6A    1010 = 3.6A    1110 = 1.6A
				0011 = 7.1A    0111 = 5.1A    1011 = 3.1A    1111 = 1.1A
REG2CL	7:4	R/W	1000 (4.1A)	Normal Current-Limit for Regulator 2 from 8.1A to 0.6A in 0.5A Decrements
				0000 = 8.6A    0100 = 6.6A    1000 = 4.6A    1100 = 2.6 A
				0001 = 8.1A    0101 = 6.1A    1001 = 4.1A    1101 = 2.1A
				0010 = 7.6A    0110 = 5.6A    1010 = 3.6A    1110 = 1.6A
				0011 = 7.1A    0111 = 5.1A    1011 = 3.1A    1111 = 1.1A

**Table 26. Current-Limit Register I<sub>OUT3</sub> and I<sub>OUT4</sub>**

Register Name	ILIMIT_3-4_REG			Current-Limit Register for V <sub>OUT3</sub> and V <sub>OUT4</sub>			
Address				0x1C'h			
Field	bit	R/W	Default	Description			
REG3CL	3:0	R/W	1000 (4.1A)	Normal Current-Limit for Regulator 3 from 8.1A to 0.6A in 0.5A Decrements			
				0000 = 8.6A	0100 = 6.6A	1000 = 4.6A	1100 = 2.6 A
				0001 = 8.1A	0101 = 6.1A	1001 = 4.1A	1101 = 2.1A
				0010 = 7.6A	0110 = 5.6A	1010 = 3.6A	1110 = 1.6A
			0011 = 7.1A	0111 = 5.1A	1011 = 3.1A	1111 = 1.1A	
REG4CL	7:4	R/W	0100 (6.1A)	Normal Current-Limit for Regulator 4 from 8.1A to 0.6A in 0.5A Decrements			
				0000 = 8.6A	0100 = 6.6A	1000 = 4.6A	1100 = 2.6 A
				0001 = 8.1A	0101 = 6.1A	1001 = 4.1A	1101 = 2.1A
				0010 = 7.6A	0110 = 5.6A	1010 = 3.6A	1110 = 1.6A
			0011 = 7.1A	0111 = 5.1A	1011 = 3.1A	1111 = 1.1A	

**Table 27. Current-Limit Register I<sub>OUT5</sub> and I<sub>OUT6</sub>**

Register Name	ILIMIT_5-6_REG			Current-Limit Register for V <sub>OUT5</sub> and V <sub>OUT6</sub>			
Address				0x1D'h			
Field	bit	R/W	Default	Description			
REG5CL	3:0	R/W	1000 (4.1A)	Normal Current-Limit for Regulator 5 from 8.1A to 0.6A in 0.5A Decrements			
				0000 = 8.6A	0100 = 6.6A	1000 = 4.6A	1100 = 2.6 A
				0001 = 8.1A	0101 = 6.1A	1001 = 4.1A	1101 = 2.1A
				0010 = 7.6A	0110 = 5.6A	1010 = 3.6A	1110 = 1.6A
			0011 = 7.1A	0111 = 5.1A	1011 = 3.1A	1111 = 1.1A	
REG6CL	6:4	R/W	011 (2.24A)	Current Limit from 2.6A to 1.78A in 0.12A Decrements			
				000 = 2.6A	010 = 2.36A	100 = 2.12A	110 = 1.88A
				001 = 2.48A	011 = 2.24A	101 = 2.00A	111 = 1.76A
	7	R/W	0	0 = Current Limit On		1 = Current Limit Off	



**Current-Limit (STBY Mode) Registers (1E – 20'h)**

This register is use to set the current limit for each DC-to-DC regulator when in standby (STBY) mode operation.

**Table 28. Standby Current-Limit Register I<sub>OUT1</sub> and I<sub>OUT2</sub>**

Register Name	STBY_ILIMIT_1-2_REG			Standby Current-Limit Register for V <sub>OUT1</sub> and V <sub>OUT2</sub>			
Address				0x1E'h			
Field	bit	R/W	Default	Description			
SB1CL	3:0	R/W	1000 (4.1A)	Standby current limit for regulator 1 from 8.6A to 0.6A in 0.5A decrements			
				0000 = 8.6A	0100 = 6.6A	1000 = 4.6A	1100 = 2.6 A
				0001 = 8.1A	0101 = 6.1A	1001 = 4.1A	1101 = 2.1A
				0010 = 7.6A	0110 = 5.6A	1010 = 3.6A	1110 = 1.6A
				0011 = 7.1A	0111 = 5.1A	1011 = 3.1A	1111 = 1.1A
SB2CL	7:4	R/W	1000 (4.1A)	Standby current limit for regulator 2 from 8.6A to 0.6A in 0.5A decrements			
				0000 = 8.6A	0100 = 6.6A	1000 = 4.6A	1100 = 2.6 A
				0001 = 8.1A	0101 = 6.1A	1001 = 4.1A	1101 = 2.1A
				0010 = 7.6A	0110 = 5.6A	1010 = 3.6A	1110 = 1.6A
				0011 = 7.1A	0111 = 5.1A	1011 = 3.1A	1111 = 1.1A

**Table 29. Standby Current-Limit Register I<sub>OUT3</sub> and I<sub>OUT4</sub>**

Register Name	STBY_ILIMIT_3-4_REG			Standby Current-Limit Register for V <sub>OUT3</sub> and V <sub>OUT4</sub>			
Address				0x1F'h			
Field	bit	R/W	Default	Description			
SB3CL	3:0	R/W	1000 (4.1A)	Standby Current Limit for Regulator 3 from 8.1A to 0.6A in 0.5A Decrements			
				0000 = 8.6A	0100 = 6.6A	1000 = 4.6A	1100 = 2.6 A
				0001 = 8.1A	0101 = 6.1A	1001 = 4.1A	1101 = 2.1A
				0010 = 7.6A	0110 = 5.6A	1010 = 3.6A	1110 = 1.6A
				0011 = 7.1A	0111 = 5.1A	1011 = 3.1A	1111 = 1.1A
SB4CL	7:4	R/W	0100 (6.1A)	Standby Current Limit for Regulator 4 from 8.1A to 0.6 A in 0.5A Decrements			
				0000 = 8.6A	0100 = 6.6A	1000 = 4.6A	1100 = 2.6 A
				0001 = 8.1A	0101 = 6.1A	1001 = 4.1A	1101 = 2.1A
				0010 = 7.6A	0110 = 5.6A	1010 = 3.6A	1110 = 1.6A
				0011 = 7.1A	0111 = 5.1A	1011 = 3.1A	1111 = 1.1A

**Table 30. Standby Current-Limit Register I<sub>OUT5</sub> and I<sub>OUT6</sub>**

Register Name	STBY_ILIMIT_5-6_REG			Standby Current-Limit Register for V <sub>OUT5</sub> and V <sub>OUT6</sub>			
Address				0x20'h			
Field	bit	R/W	Default	Description			
SB5CL	3:0	R/W	1000 (4.1A)	Standby Current Limit for Regulator 5 from 8.1A to 0.6A in 0.5A Decrements			
				0000 = 8.6A	0100 = 6.6A	1000 = 4.6A	1100 = 2.6 A
				0001 = 8.1A	0101 = 6.1A	1001 = 4.1A	1101 = 2.1A
				0010 = 7.6A	0110 = 5.6A	1010 = 3.6A	1110 = 1.6A
				0011 = 7.1A	0111 = 5.1A	1011 = 3.1A	1111 = 1.1A
SB6CL	6:4	R/W	011 (2.24A)	Current Limit from 2.6A to 1.78A in 0.12A Decrements			
				000 = 2.6A	010 = 2.36A	100 = 2.12A	110 = 1.88A
				001 = 2.48A	011 = 2.24A	101 = 2.00A	111 = 1.76A
	7	R/W	0	0 = Current Limit On		1 = Current Limit Off	

**Power-on-Reset (POR) Threshold Voltage Setting Register (21'h and 22'h)**

This register is used to set the rising and falling threshold of power-on-reset (POR) comparator. Refer to [Table 20](#) for POR time delay settings.

**Table 31. Rising and Falling Power-on-Reset Threshold Voltage Settings**

Register Name				Rising and Falling Power On Reset Threshold Voltage Setting			
	bit	R/W	Default	Description			
VSCLT	4:0	R/W	00000	3.3V to 2.3V in 50mV Decrements			
				00000 = 3.25V	01000 = 2.85V	10000 = 2.45V	11000 = 2.25V
				00001 = 3.20V	01001 = 2.80V	10001 = 2.40V	11001 = 2.25V
				00010 = 3.15V	01010 = 2.75V	10010 = 2.35V	11010 = 2.25V
				00011 = 3.10V	01011 = 2.70V	10011 = 2.30V	11011 = 2.25V
				00100 = 3.05V	01100 = 2.65V	10100 = 2.25V	11100 = 2.25V
				00101 = 3.00V	01101 = 2.60V	10101 = 2.25V	11101 = 2.25V
				00110 = 2.95V	01110 = 2.55V	10110 = 2.25V	11110 = 2.25V
				00111 = 2.90V	01111 = 2.50V	10111 = 2.25V	11111 = 2.25V

The three most significant bits [7:5] in Registers 21'h and 22'h are used to mask the output voltage power-good flag after the start-up sequenced is finished.

**Table 32. Power-on-Reset Rising Threshold Voltage Setting Register (21'h)**

Register Name	PORUO_REG			Power-on-Reset Falling Threshold	
Address				0x21'h	
Field	bit	R/W	Default	Description	
PORUP	4:0	R/W	01011 (2.7V)	See <a href="#">Table 28</a>	
PGOOD_MASK1	5	R/W	1	0 = Do Not Mask PGOOD1	1 = Mask PGOOD1
PGOOD_MASK2	6	R/W	1	0 = Do Not Mask PGOOD2	1 = Mask PGOOD2
PGOOD_MASK3	7	R/W	1	0 = Do Not Mask PGOOD3	1 = Mask PGOOD3

**Table 33. Power-on-Reset Falling Threshold Voltage Setting Register (22'h)**

Register Name	PORDN_REG			Power-on-Reset Falling Threshold	
Address				0x22'h	
Field	bit	R/W	Default	Description	
PORDN	4:0	R/W	01101 (2.6V)	See <a href="#">Table 28</a>	
PGOOD_MASK4	5	R/W	1	0 = Do Not Mask PGOOD4	1 = Mask PGOOD4
PGOOD_MASK5	6	R/W	1	0 = Do Not Mask PGOOD5	1 = Mask PGOOD5
PGOOD_MASK6	7	R/W	1	0 = Do Not Mask PGOOD6	1 = Mask PGOOD6

**Pull-Down when Disabled Register (23'h)**

This register is used to set the preference of enabling/disabling a pull-down FET when the DC-to-DC regulators are disabled. The pull-down value for buck regulators 1 – 5 is 90Ω. The pull-down current value for the boost regulator 6 is programmable.

**Table 34. Pull-Down when Disabled Register**

Register Name	PULLDN1-6_REG			Pull-Down when Disabled Register			
Address				0x23'h			
Field	bit	R/W	Default	Description			
PULLD1	0	R/W	0	Enable/Disable the Pull-Down on Regulator 1 when Power-Down			
				0 = No Pull Down		1 = Pull-Down	
PULLD2	1	R/W	0	Enable/Disable the Pull-Down on Regulator 2 when Power-Down			
				0 = No Pull-Down		1 = Pull-Down	
PULLD3	2	R/W	0	Enable/Disable the Pull-Down on Regulator 3 when Power-Down			
				0 = No Pull-Down		1 = Pull Down	
PULLD4	3	R/W	0	Enable/Disable the Pull-Down on Regulator 4 when Power-Down			
				0 = No Pull-Down		1 = Pull-Down	
PULLD5	4	R/W	0	Enable/Disable the Pull-Down on Regulator 5 when Power-Down			
				0 = No Pull-Down		1 = Pull-Down	
PULLD6C	6:5	R/W	00	Sets Boost Pull-Down Current Level			
				00 = 148mA	01 = 111mA	10 = 74mA	11 = 37mA
PULLD6	7	R/W	0	Enable/Disable the Pull-Down on Regulator 6 when Power-Down			
				0 = No Pull-Down		1 = Pull-Down	

---

**MICREL, INC. 2180 FORTUNE DRIVE SAN JOSE, CA 95131 USA**  
TEL +1 (408) 944-0800 FAX +1 (408) 474-1000 WEB <http://www.micrel.com>

Micrel, Inc. is a leading global manufacturer of IC solutions for the worldwide high-performance linear and power, LAN, and timing & communications markets. The Company's products include advanced mixed-signal, analog & power semiconductors; high-performance communication, clock management, MEMs-based clock oscillators & crystal-less clock generators, Ethernet switches, and physical layer transceiver ICs. Company customers include leading manufacturers of enterprise, consumer, industrial, mobile, telecommunications, automotive, and computer products. Corporation headquarters and state-of-the-art wafer fabrication facilities are located in San Jose, CA, with regional sales and support offices and advanced technology design centers situated throughout the Americas, Europe, and Asia. Additionally, the Company maintains an extensive network of distributors and reps worldwide.

Micrel makes no representations or warranties with respect to the accuracy or completeness of the information furnished in this datasheet. This information is not intended as a warranty and Micrel does not assume responsibility for its use. Micrel reserves the right to change circuitry, specifications and descriptions at any time without notice. No license, whether express, implied, arising by estoppel or otherwise, to any intellectual property rights is granted by this document. Except as provided in Micrel's terms and conditions of sale for such products, Micrel assumes no liability whatsoever, and Micrel disclaims any express or implied warranty relating to the sale and/or use of Micrel products including liability or warranties relating to fitness for a particular purpose, merchantability, or infringement of any patent, copyright, or other intellectual property right.

Micrel Products are not designed or authorized for use as components in life support appliances, devices or systems where malfunction of a product can reasonably be expected to result in personal injury. Life support devices or systems are devices or systems that (a) are intended for surgical implant into the body or (b) support or sustain life, and whose failure to perform can be reasonably expected to result in a significant injury to the user. A Purchaser's use or sale of Micrel Products for use in life support appliances, devices or systems is a Purchaser's own risk and Purchaser agrees to fully indemnify Micrel for any damages resulting from such use or sale.

© 2015 Micrel, Incorporated.