

# Clarki Quad-band M2M Antenna

Part No. A10464

gigaNOVA®

Product Specification

## 1 Features

- Adjustable GSM antenna targeting M2M applications
- Resonant frequency adjustable using single tuning component
- Space-saving corner mount enables antenna space to be shared with GSM module
- Works in both upper right and left corners
- High efficiency
- Easy to integrate
- Intended for corner mounting with screw fixings (x2)
- Supplied in trays

Clarki supports the following communication standards:

GSM/GPRS/EDGE	Other Standards
GSM850 (E)GSM900 GSM1800 (DCS) GSM1900 (PCS)	CDMA Band II CDMA Band V Korean PCS AWS



## 2 Description

A10464 is designed to be mounted in either corner of a PCB by means of a robust screw-in fixing ideal for M2M application. The design allows an SMT GSM/GPRS module to occupy part of the space under the antenna, allowing an optimal use of the space on the host PCB. The antenna is not symmetric, and therefore performance when mounted on left and right corner is slightly different, with a little advantage in the left corner position.

A10464 uses the host PCB ground plane in order to radiate efficiently and so its performance depend also on the size and design of the host PCB; a minimum PCB length of 100mm is recommended, although the antenna works on smaller PCBs, with performance decreasing with PCB size. The ground plane extends under the antenna, but for optimal performance a 3mm ground clearance strip along the edge of the PCB in correspondence of the antenna is recommended.

The antenna uses a matching circuit to achieve optimized results for the specific frequency bands that are required, and the resonant frequency of the antenna can be adjusted using an additional component to compensate for the effect of nearby objects like a plastic cover. This product specification shows the performance of the antenna on an Antenova reference board, A10464-U1, when optimized to cover a typical quad-band reception: GSM850/900/1800/1900.

### 3 Applications

- Smart Metering/AMR
- Tracker devices
- Industrial Applications
- Femto / Pico base stations
- Other M2M communication

### 4 Part number

Clarki: A10464



### 5 General data

Product Name	Clarki GSM
Part Number	A10464
Frequency	824 – 960 MHz 1710 –1990 MHz
Polarization	Linear
Operating Temperature	-40 °C to +85 °C
Impedance with Matching	50 Ω
Weight	1.3 g
Antenna Type	Corner Mount / Screw Fixing (x2)
Connection Type	Pogo pins or Spring Contacts (x2)
Dimensions	26.10 x 26.10 x 10.15 [mm]
Material	FPC on plastic carrier

## 6 Electrical characteristics

	Typical Performance				
	Frequency	Left Corner	Right Corner	Left Corner With Module <sup>1</sup>	Right Corner With Module <sup>1</sup>
<b>Peak Gain [dBi]</b>	824-960 MHz	1.4	1.0	1.3	1.0
	1710-1990 MHz	2.4	3.0	2.2	2.7
<b>Minimum Efficiency [%]</b>	824-960 MHz	55	59	53	57
	1710-1990 MHz	67	57	62	52
<b>Average Efficiency [%]</b>	824-960 MHz	62	64	60	63
	1710-1990 MHz	73	64	68	60
<b>Minumum Return Loss [dB]</b>	824-960 MHz	7.0	7.4	6.8	7.2
	1710-1990 MHz	8.0	6.2	7.2	6.0
<b>VSWR</b>	824-960 MHz	2.6:1	2.5:1	2.7:1	2.5:1
	1710-1990 MHz	2.3:1	2.9:1	2.5:1	3.0:1

### Conditions

All data measured on Antenova's reference board, part number A10464-U1.

<sup>1</sup>Typical commercially available SMT GSM Module

## 7 Electrical performance

### 7-1 Return Loss

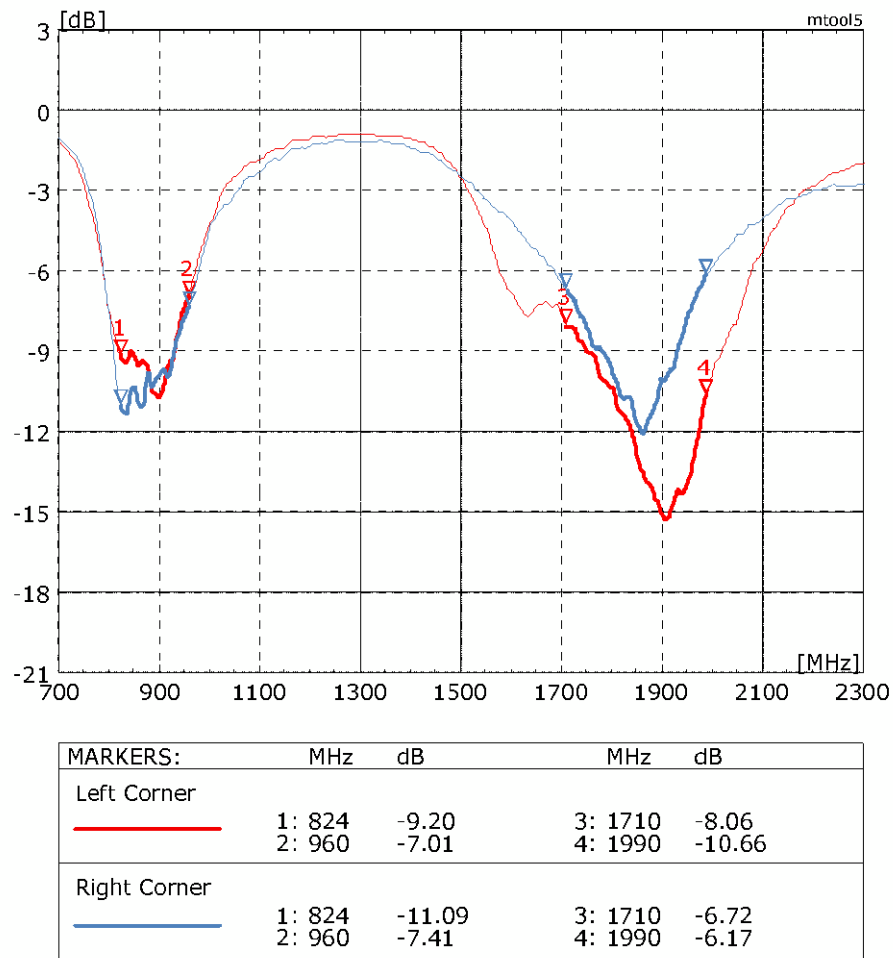
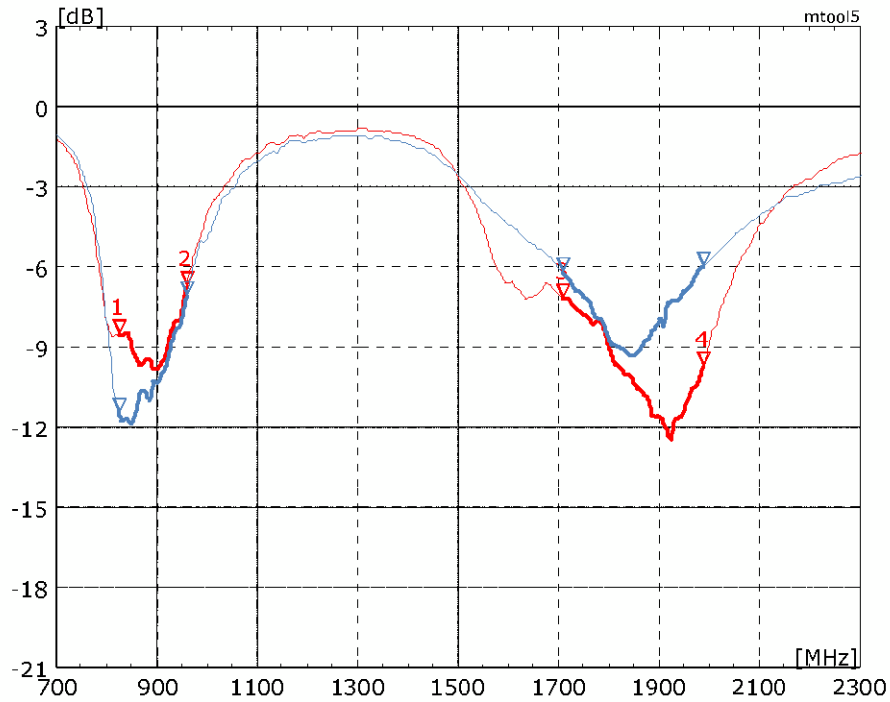

Figure 1: Impedance Matching (Left and Right positions) - No module



MARKERS:	MHz	dB	MHz	dB
Left Corner - With Module				
— (Red)	1: 824	-8.60	3: 1710	-7.20
	2: 960	-6.78	4: 1990	-9.78
Right Corner - With Module				
— (Blue)	1: 824	-11.53	3: 1710	-6.26
	2: 960	-7.20	4: 1990	-6.02

Figure 2: Impedance Matching (Left and Right positions) - with typical SMT GSM Module

## 7-2 VSWR

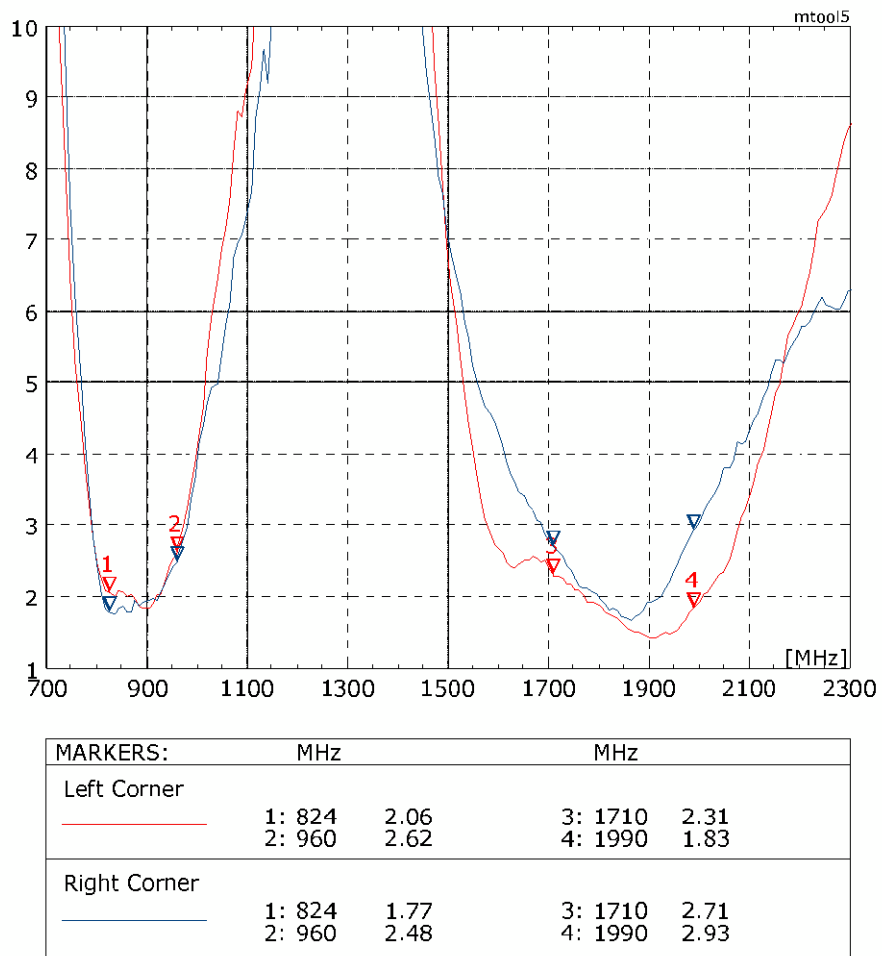
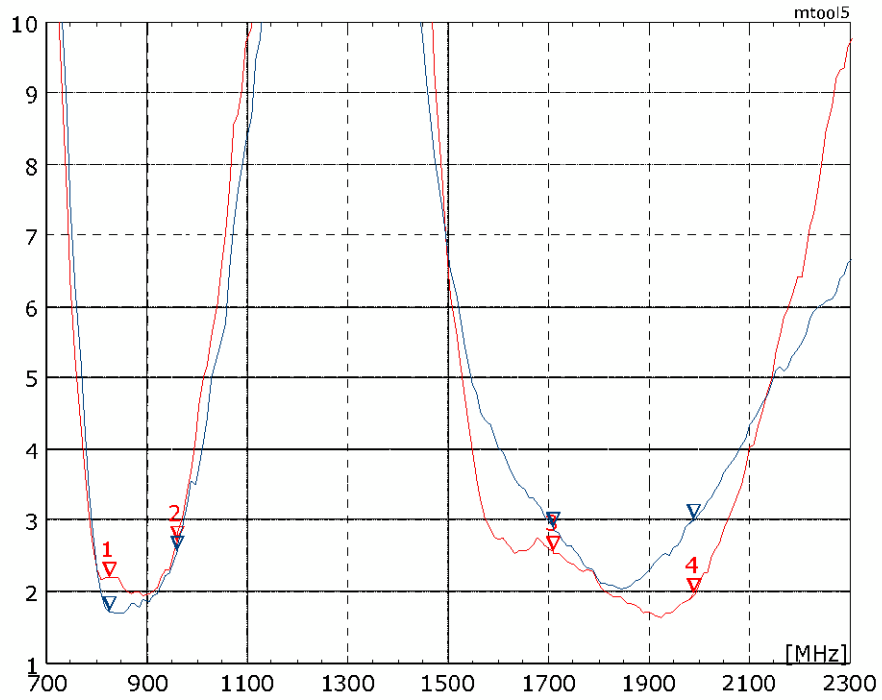

Figure 3: Left and Right positions – no module



MARKERS:	MHz	MHz
Left Corner - With Module		
— (Red)	1: 824	2.18
	2: 960	2.69
Right Corner - With Module		
— (Blue)	1: 824	1.72
	2: 960	2.55
	3: 1710	2.89
	4: 1990	3.00

Figure 4 Left and Right positions - with typical SMT GSM Module

### 7-3 Antenna efficiency

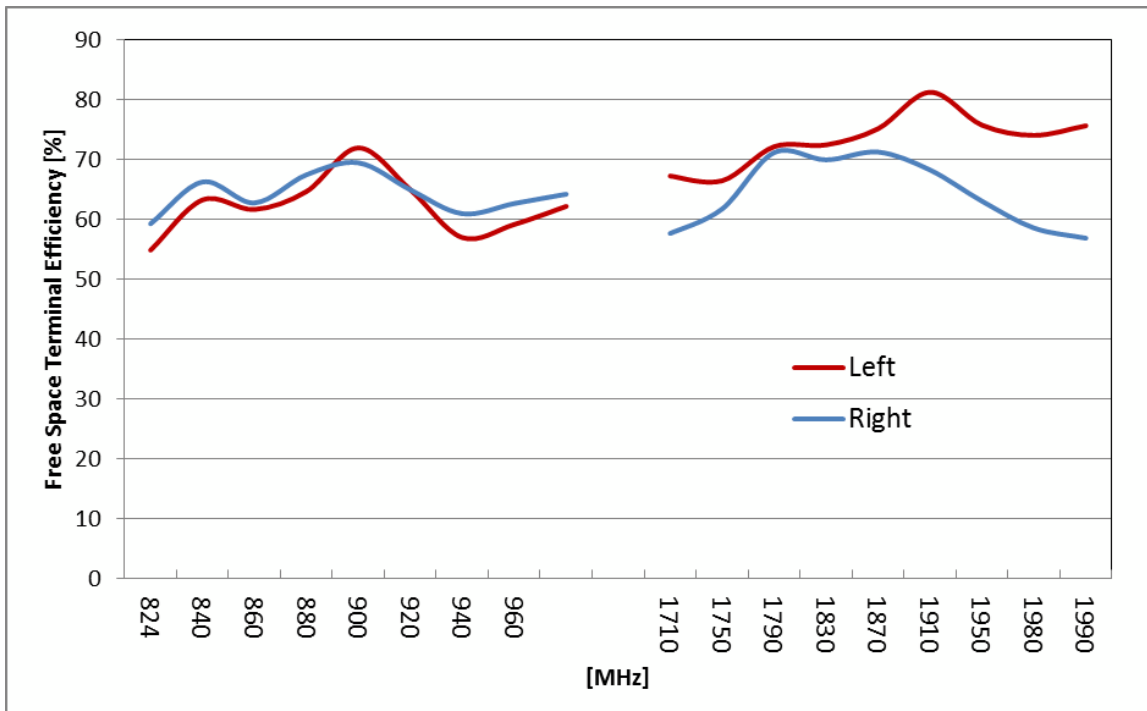

Figure 5: Left and Right positions - No module

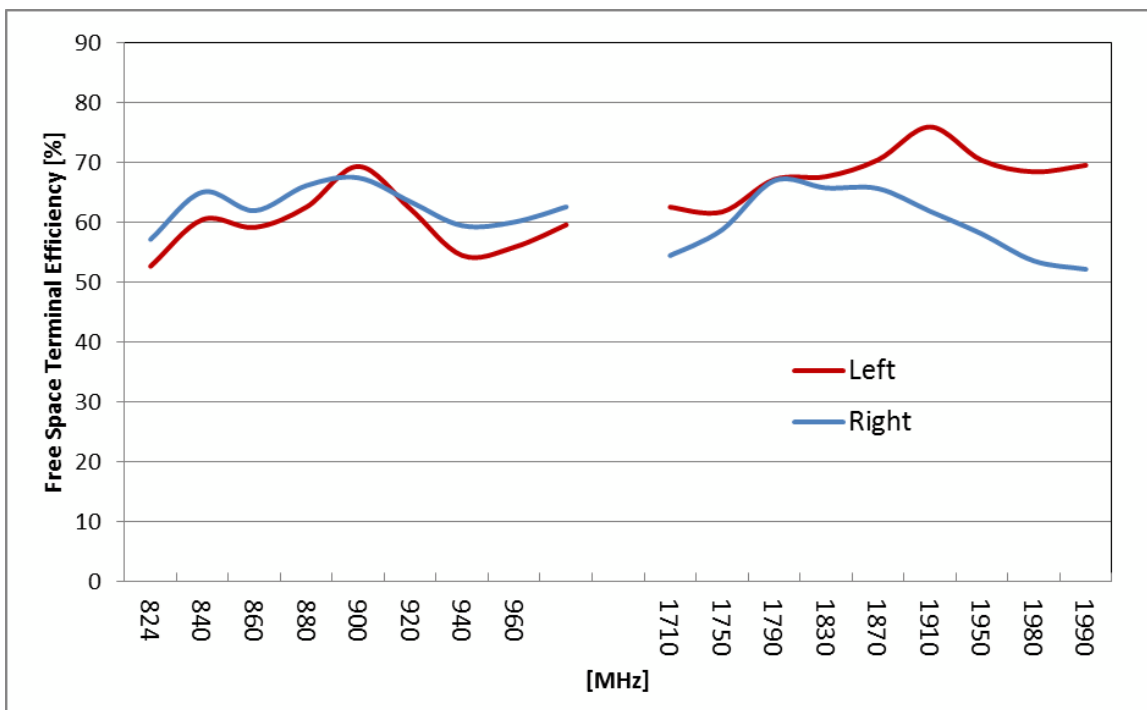
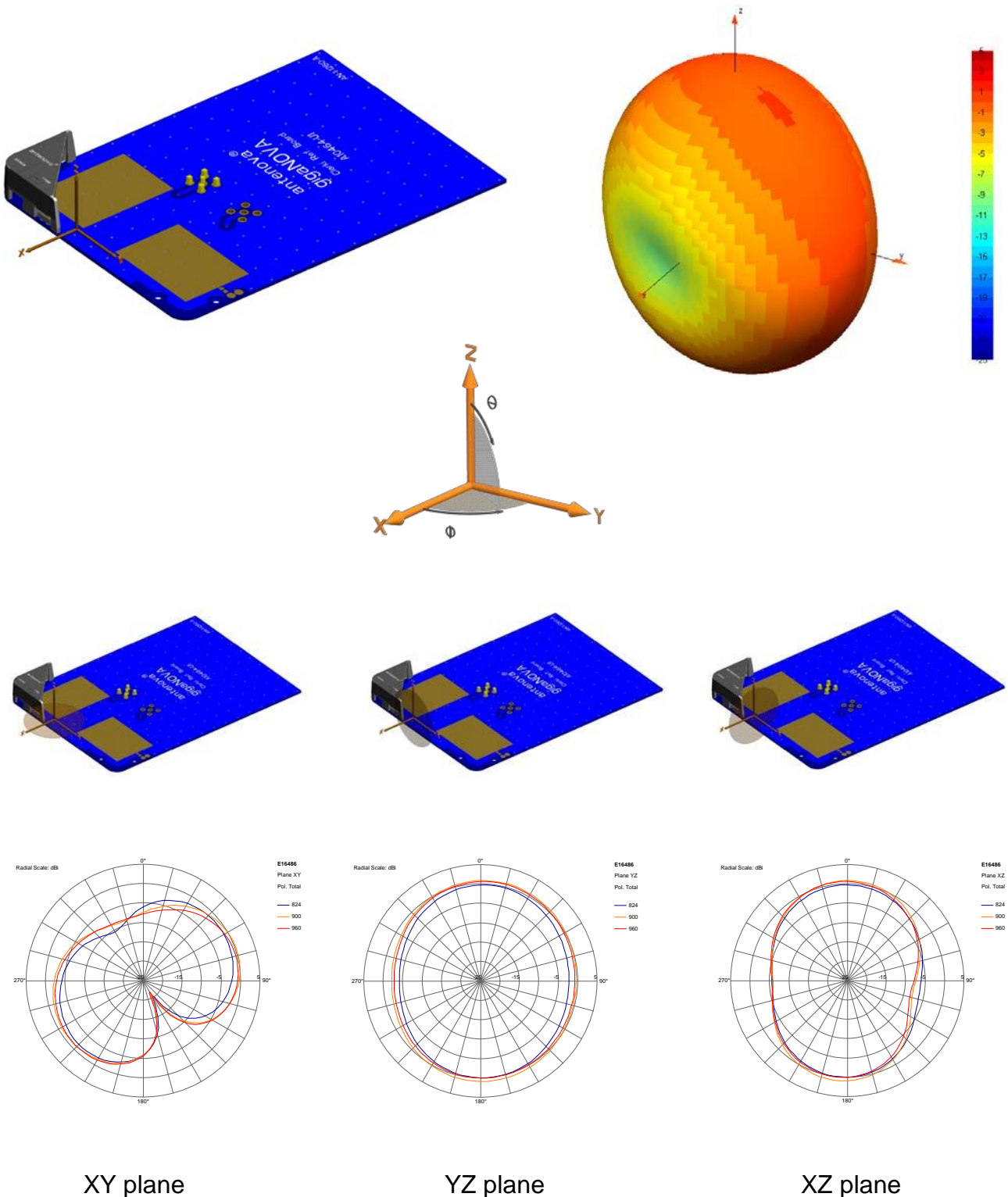

Figure 6: Left and Right positions - with typical SMT GSM Module



## 7-4 Antenna patterns (Right mount) 824-960 MHz



Patterns show combined polarisations measured on reference board A10464-U1. 3D Pattern measured at 890 MHz

## 7-5 Antenna patterns (Left mount) 824-960 MHz

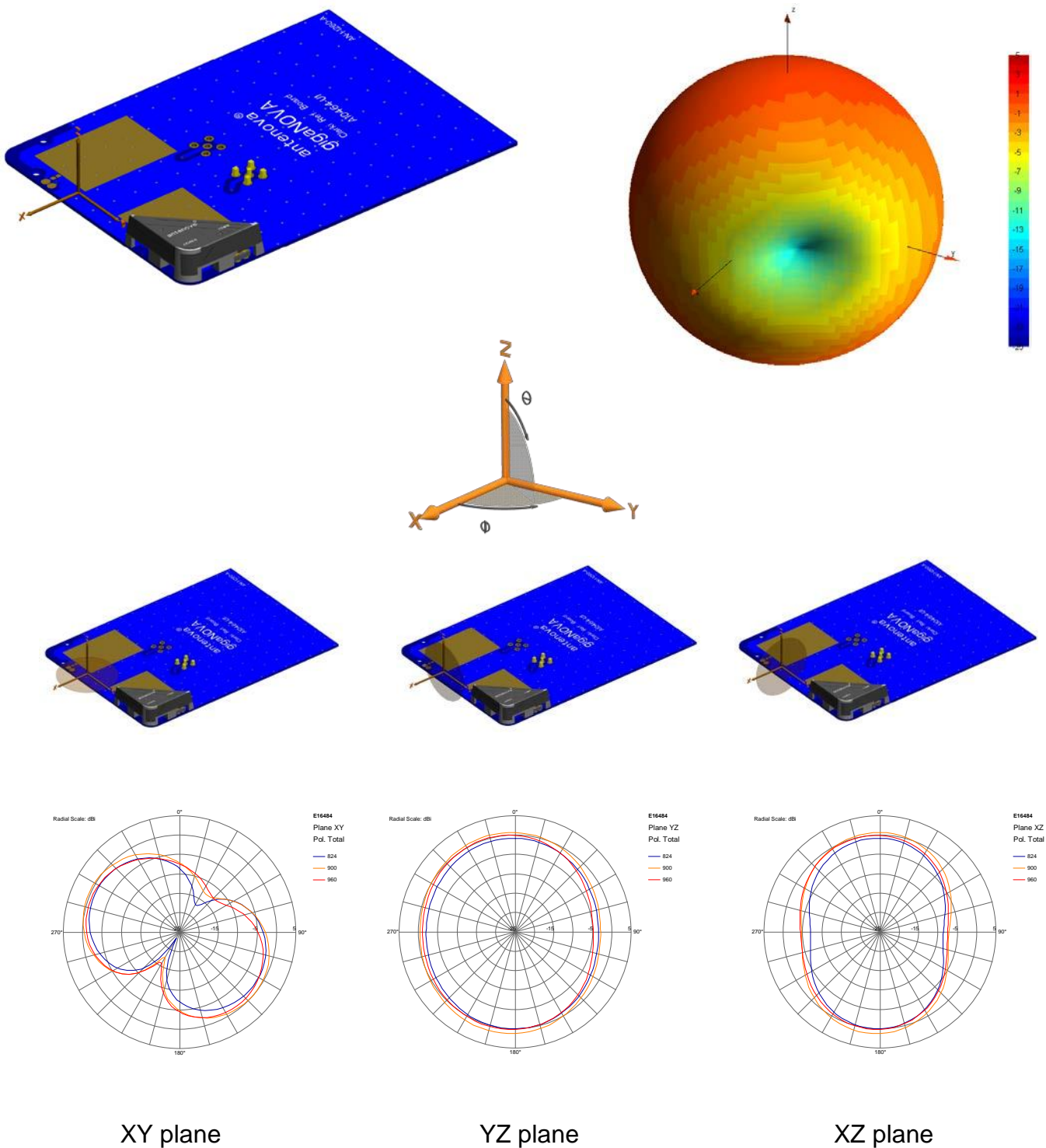

Patterns show combined polarisations measured on reference board A10464-U1. 3D Pattern measured at 890 MHz

## 7-6 Antenna patterns (Right mount) 1710 - 1990 MHz

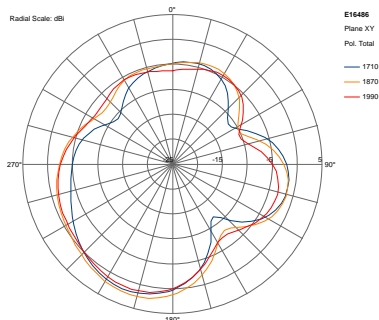
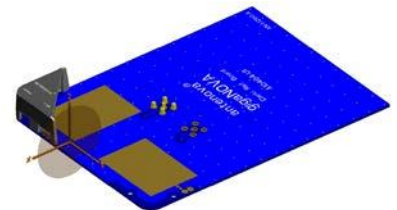
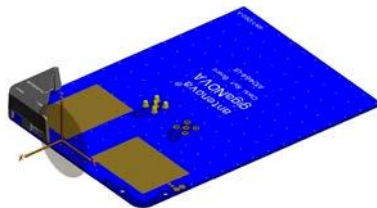
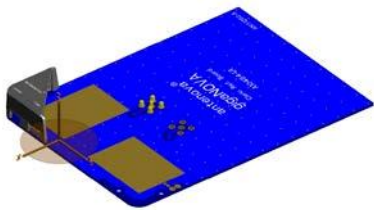
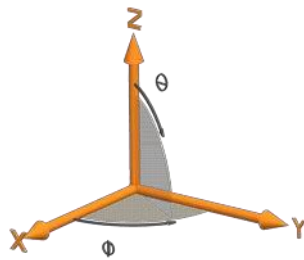
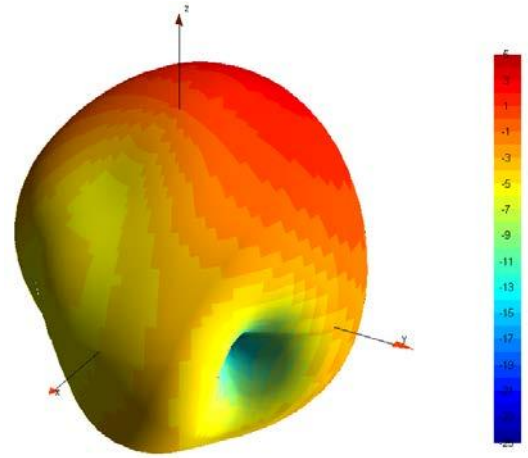
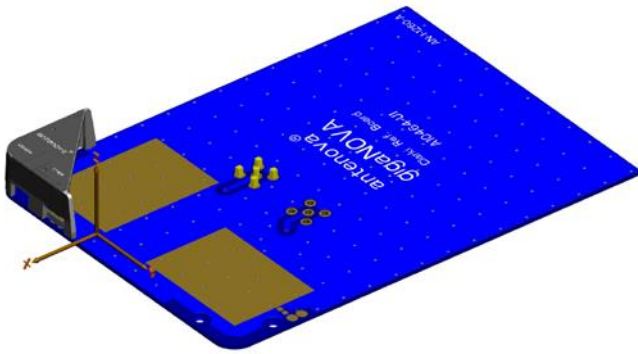

XY plane

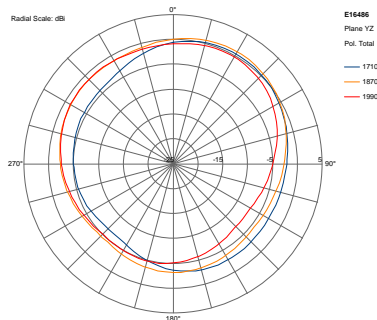

YZ plane

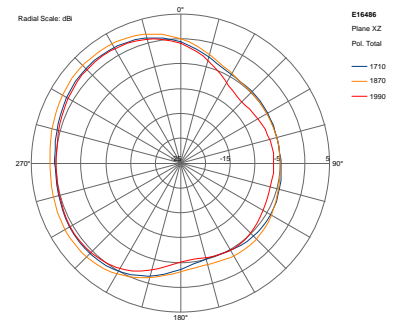

XZ plane

Patterns show combined polarisations measured on reference board A10464-U1. 3D Pattern measured at 1870 MHz

## 7-7 Antenna patterns (Left mount) 1710 – 1990 MHz

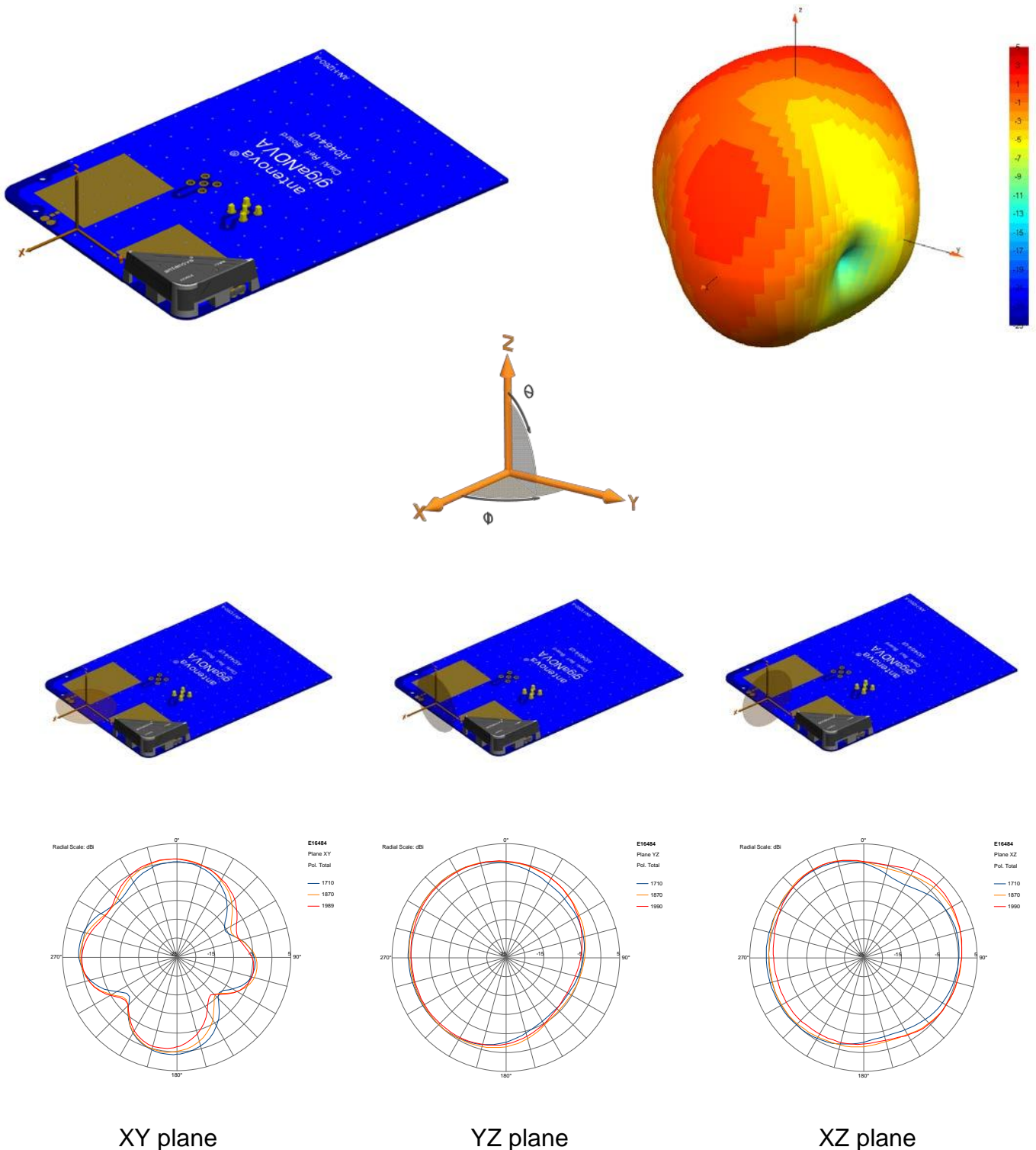

Patterns show combined polarisations measured on reference board A10464-U1. 3D Pattern measured at 1870 MHz

# Antennas for Wireless M2M Applications

## 8 Antenna dimensions

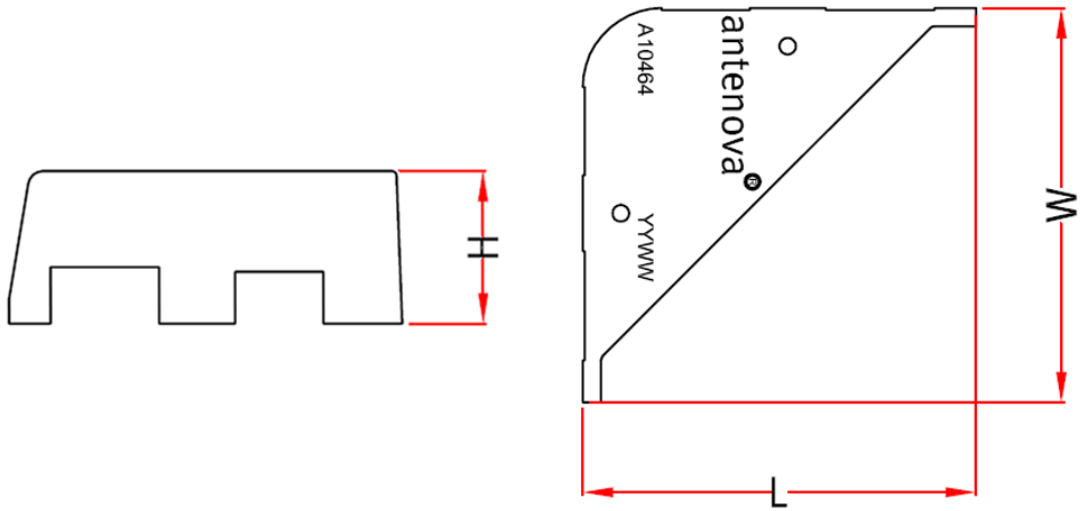

Top View

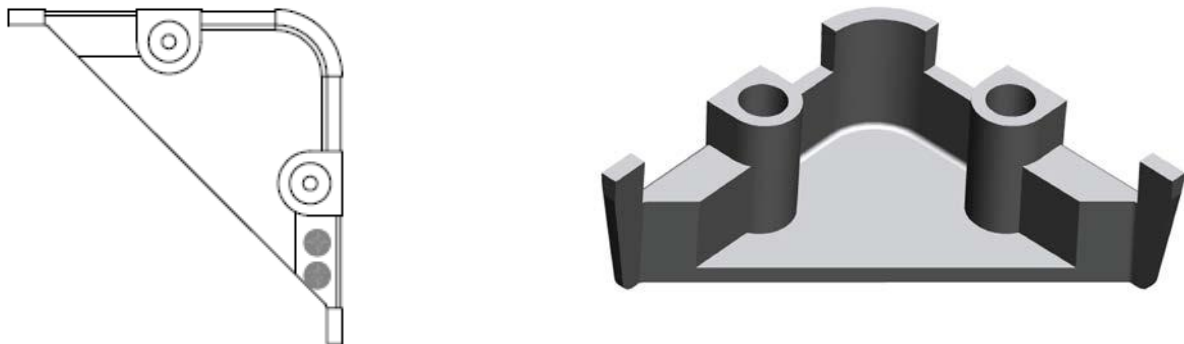

Bottom View

L	W	H
Length	Width	Height
26.10 +/- 0.2	26.10 +/-0.2	10.15 +/- 0.15

Dimensions in mm

### Clarki GSM (Part No: A10464) antenna dimensions

3D model of the antenna is available from Antenova M2M on request. Please contact [sales@antenova-m2m.com](mailto:sales@antenova-m2m.com) for further details.

## 9 Antenna footprint

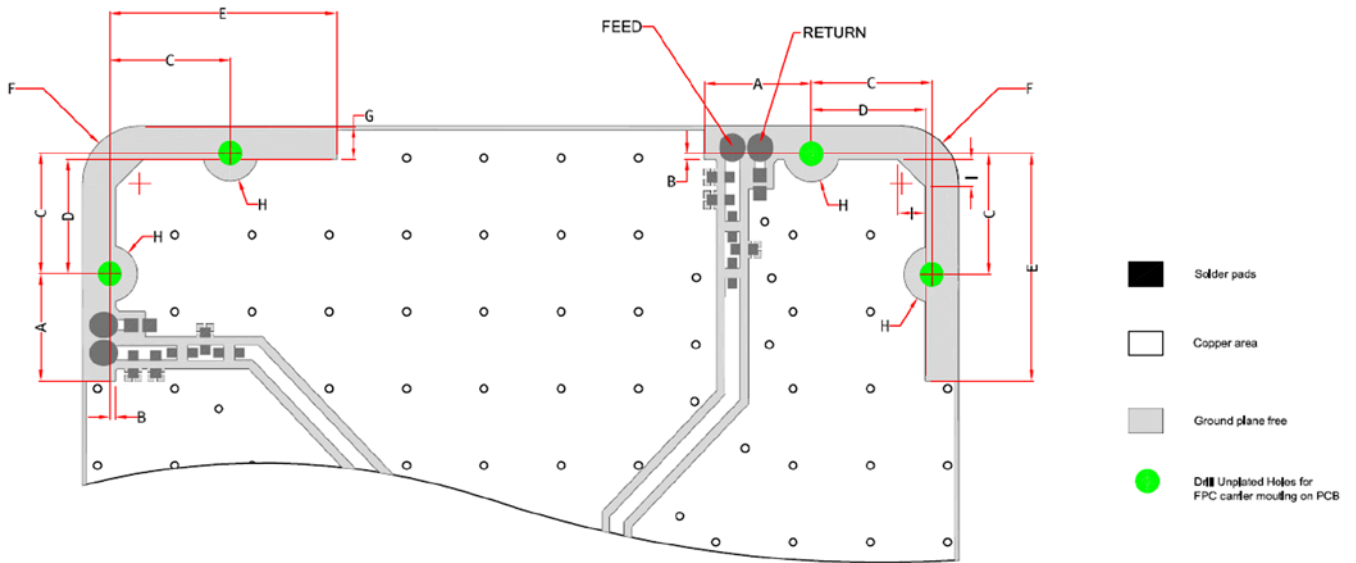

### Clarki GSM (Part No: A10464) Placement on PCB

CAD files of the antenna footprint are available from Antenova M2M on request. Please contact [sales@antenova-m2m.com](mailto:sales@antenova-m2m.com) for further details.

A	B	C	D	E	F	G	H	I
9.78 ±0.15	0.5 ±0.15	11.0 ±0.15	10.42 ±0.15	20.70 ±0.15	10.40 ±0.15	2.98 ±0.15	5.00 DIA ±0.15	2.50 ±0.15

Dimensions in millimeters

## 10 Electrical interface

### 10-1 Transmission lines

The antenna should be connected using an RF transmission line.

All transmission lines should be designed to have a characteristic impedance of  $50\ \Omega$ . The length of the transmission lines should be kept to a minimum. Any other parts of the RF system like transceivers, power amplifiers, etc, should also be designed to have an impedance of  $50\ \Omega$ .

Once the material for the PCB has been chosen (PCB thickness and dielectric constant), a co-planar transmission line can easily be designed using any of the commercial software packages for transmission line design. For the chosen PCB thickness, copper thickness and substrate dielectric constant, the program will calculate the appropriate transmission line width and gaps on either side of the track so the characteristic impedance of the co-planar transmission line is  $50\ \Omega$ .

Please contact Antenova M2M ([sales@antenova-m2m.com](mailto:sales@antenova-m2m.com)) if assistance is required.

### 10-2 Matching circuit

The A10464 antenna requires an impedance matching circuit that must be optimized for each customer's product. The matching circuit will typically require 3 matching components, and up to five components depending on the impedance of the antenna when situated in the device. It is recommended that all the components in the reference schematic (Fig 7) are included in the layout. Moreover, the antenna requires an additional inductor L1 on the return pin, which is used to adjust the resonant frequency in the low band (see below).

**Important:** The position of the antenna feed and return pads are fixed for this product and the positions cannot be swapped over. Please check the reference layout for the relative position.

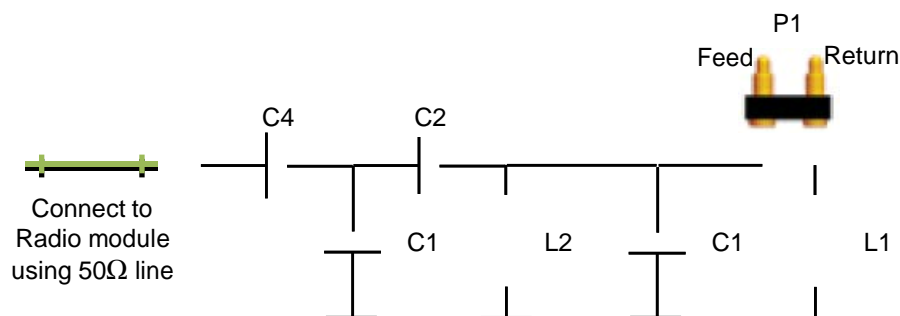

Figure 7: Antenna matching circuit and frequency adjustment

The values of the matching component given in the below table are for the A10464-U1 reference boards and might be different on a customer host board.

Designator	Value	Tolerance	Size	Manufacturer	PN
L1	3.9nH	±0.2nH	0402	Murata	LQW15AN3N9C00
L2	8.2nH	±3%	0402	Murata	LQW15AN8N2H00
C1	-		0402		Not fitted
C2	2.7pF	±0.1pF	0402	AVX	04023U2R7BAT2A
C3	0.5pF	±0.1pF	0402	AVX	04025U0R5BAT2A
C4	33pF	±5%	0402	Any	
P1	See below				

**Note:** The component values for the matching circuit will vary depending on the size of the PCB and surrounding components. The impedance of the antenna should be measured before selecting suitable matching components. Antenova offers a matching service on request. Contact [info@antenova.com](mailto:info@antenova.com) for further information

## Antenna frequency adjustment

The resonant frequency of the antenna can be adjusted to compensate small detuning caused by nearby objects like a plastic case or a large metal component. The adjustment does mostly affect the low-band resonance [824-960MHz], with a smaller effect on the upper frequency band [1710-1990MHz].

The adjustment in the resonant frequency is achieved by changing the value of the inductor on the grounding connection of the antenna:

- Decreasing the value of the inductor increases the resonant frequency, at an approximate rate of 20MHz/nH
- Increasing the value of the inductor increases the resonant frequency, at the same approximate rate of 25MHz/nH

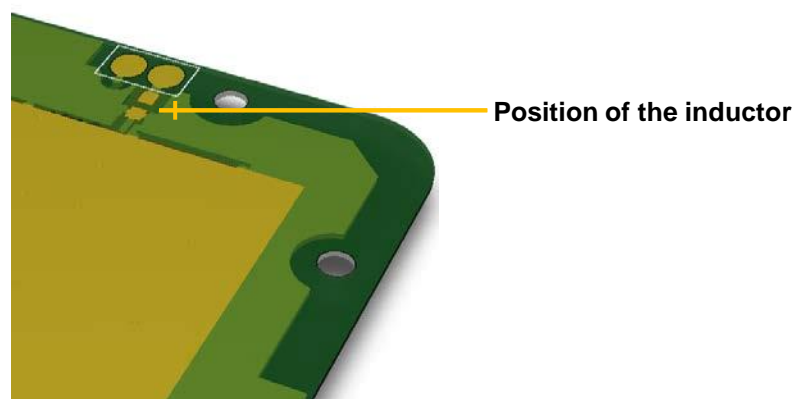
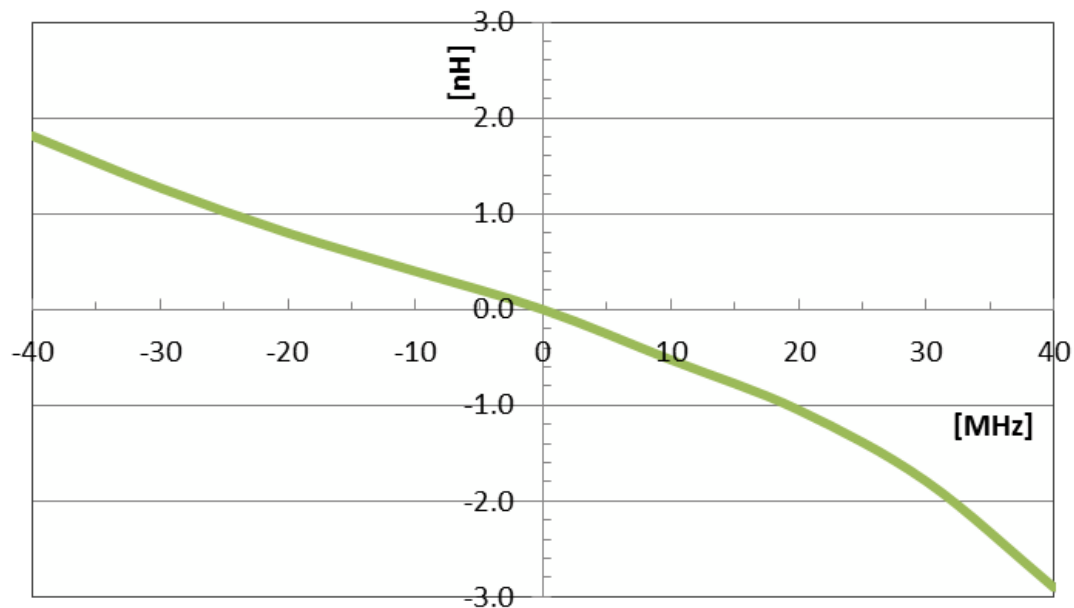



Figure 8 graphically shows the relation between the desired variation in frequency and the corresponding required variation in the inductor value.



**Figure 8 Variation of inductance required for the desired change in the low-band resonant frequency**

The plot is used as in this example:

- If the resonant frequency in the low-band has to be decreased by 25MHz, then the value of the inductor has to be increased by 1nH; to decrease the frequency 40MHz, increase the inductor 1.8nH.
- If the resonant frequency in the low-band has to be increase by 20MHz, then the value of the inductor has to be decrease by 1nH; to increase the frequency 40MHz, decrease the inductor 2.9nH.

### 10-3 Antenna placement

Clarki should be fitted to the device so that power from the antenna can radiate into free space. Antenova strongly recommends placing the antenna in a corner of the board. A low profile (<3.5mm) GSM/GPRS module can be placed under the antenna as shown in Fig.9 below. The placements shown here are for guidance only, as the actual performance differences will depend on each individual device.

Antenova M2M offers a full range of development support to ensure efficient implementation of the antenna into the specific design. To overcome RF design issues, matching circuits, transmission lines, layout and other components, please contact Antenova M2M ([sales@antenova-m2m.com](mailto:sales@antenova-m2m.com)) for design and placement recommendations.

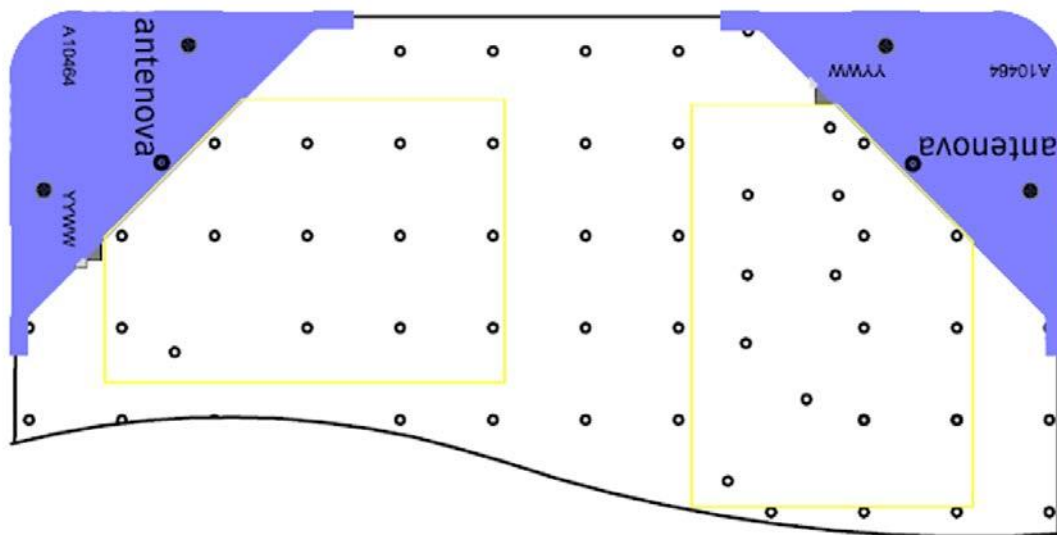
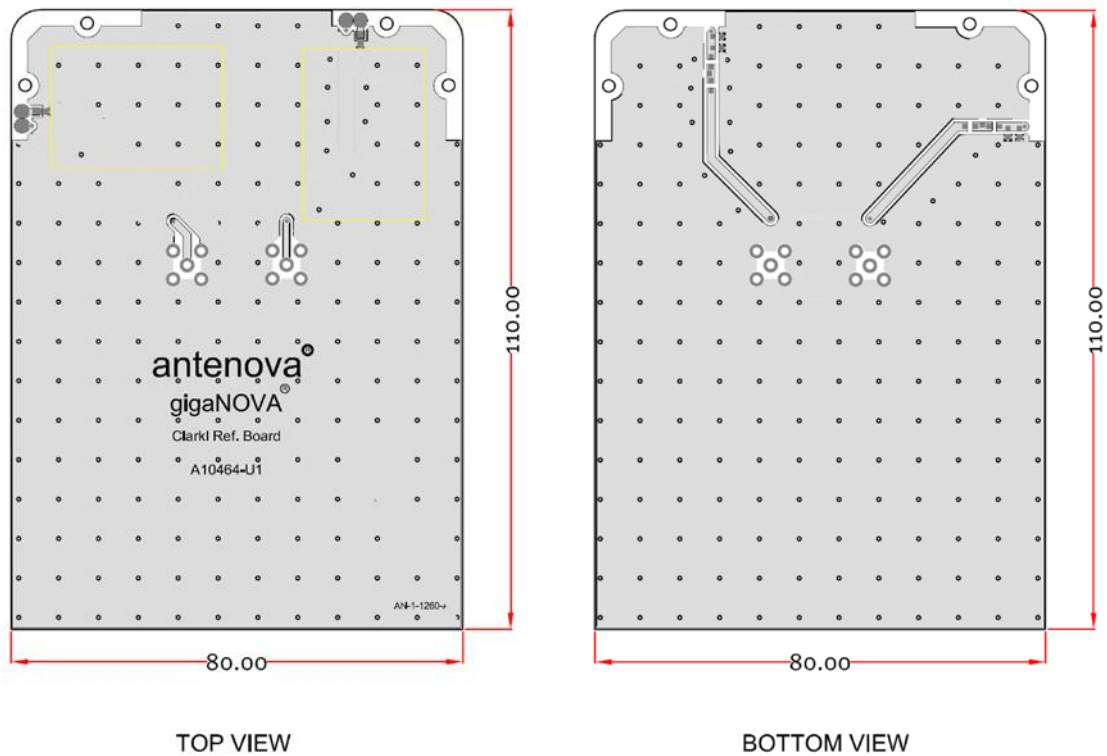

Figure 9: Recommended right or left corner placement of antenna with possible GSM/GPRS module placement outlined in yellow.

## 10-4 Reference boards

The reference board has been designed for evaluation purposes of Clarki GSM antenna and it includes a SMA female connector. The reference board is available with Clarki tuned to cover 4 bands: GSM850/900/1800/1900, Part number: A10464-U1. NB: the matching circuit is on the bottom side of the A10464-U1 reference board.



Dimensions in mm

Note: Other size reference boards are available for typical applications. Contact [sales@antenna-m2m.com](mailto:sales@antenna-m2m.com) for further information or to order a reference board.

## 11 Mounting

This antenna is intended for fixing utilizing two metal M2x4 or M2x4.5 screws.

### 11-1 Connection

For the spring pin (a.k.a. “pogo pins”) P1 in the reference schematic, the recommended parts are:

- C.C.P. F618AA01-02254MR (<http://www.pccp.com.tw/>) [pair]
- C.C.P. N103M1 (<http://www.pccp.com.tw/>) [single]
- C.C.P. N103M5-02B250MR (<http://www.pccp.com.tw/>) [pair]
- Mill-Max 0900-1-00-00-00-00-11-0 (<http://www.mill-max.com>) [single]

## 12 Hazardous material regulation conformance

The antenna has been tested to conform to RoHS requirements.

## 13 Packaging

Clarki to be supplied in trays. Please contact Antenova to discuss your tray requirements.



**[www.antenova-m2m.com](http://www.antenova-m2m.com)**

**Corporate Headquarters**

Antenova Ltd.  
2<sup>nd</sup> Floor Titan Court  
3 Bishop Square  
Hatfield  
AL10 9NA

**North America Headquarters**

Antenova Ltd.  
Rogers Business Park  
2541 Technology Drive Suite 403  
Elgin, IL 60124

**Asia Headquarters**

Antenova Asia Ltd.  
4F, No. 324, Sec. 1, Nei-Hu Road  
Nei-Hu District  
Taipei 11493  
Taiwan, ROC

**Tel:** +44 1223 810600  
**Email:** sales@antenova-m2m.com

**Tel:** +1 (847) 551 9710  
**Email:** sales@antenova-m2m.com

**Tel:** +886 (0) 2 8797 8630  
**Fax:** +886 (0) 2 8797 6890  
**Email:** sales@antenova-m2m.com

**Copyright® Antenova Ltd.** All Rights Reserved. Antenova®, Antenova M2M®, gigaNOVA®, and the Antenova and Antenova M2M logos are trademarks and/or registered trademarks of Antenova Ltd. Any other names and/or trademarks belong to their respective companies.

The materials provided herein are believed to be reliable and correct at the time of print. Antenova does not warrant the accuracy or completeness of the information, text, graphics or other items contained within these information. Antenova further assumes no responsibility for the use of this information, and all such information shall be entirely at the user's risk.



Certificate No: 4598

**Antennas for Wireless M2M Applications**