



## Features

- High-speed performance
- Superior overcurrent protection
- Bidirectional
- Low resistance
- Excellent channel to channel resistance matching
- Small SMT package

- RoHS compliant\* and halogen free\*\*

## Applications

- VDSL and Ethernet ports
- Protection modules and dongles
- Process control equipment
- Test and measurement equipment

# TCS-DL Series - TCS™ Dual Transient Current Suppressors

## General Information

The Bourns® TCS™ DL Series High-Speed Protector products contain dual, well-matched, low resistance, bidirectional, very high-speed Transient Current Suppressors. By limiting the maximum current to a safe level, a Bourns® TCS™ DL device offers superior protection for very high data rate differential lines against faults caused by short circuits, induction and lightning surges.

Bourns® TCS™ High-Speed Protectors are typically used in conjunction with low capacitance TVS devices to form an extremely low let-through energy barrier to excessive voltages and currents during surge events which may cause damage to unprotected high-speed, low voltage driver and receiver components.

The Bourns® TCS™ High-Speed Protector is provided in a space-saving, surface mount DFN package meeting industry standard requirements such as RoHS and Pb Free solder reflow profiles.

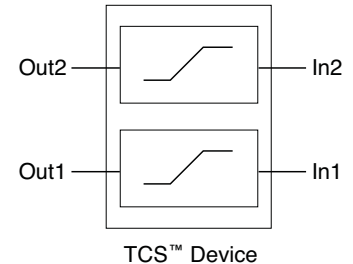

## Absolute Maximum Ratings (@ T<sub>A</sub> = 25 °C Unless Otherwise Noted)

Symbol	Parameter	Value	Unit
V <sub>imp</sub>	Peak impulse voltage withstand with duration less than 1 ms	40	V
T <sub>op</sub>	Operating temperature range	-55 to +125	°C
T <sub>stg</sub>	Storage temperature range	-65 to +150	°C
T <sub>JMAX</sub>	Maximum junction temperature	+125	°C

## Electrical Characteristics (@ T<sub>A</sub> = 25 °C Unless Otherwise Noted)

Symbol	Parameter	Part Number	Min.	Typ.	Max.	Unit
I <sub>trigger</sub>	Current required for the device to go from operating state to protected state	TCS-DL004-250-WH TCS-DL004-500-WH TCS-DL004-750-WH	250 500 750	375 750 1100	500 1000 1500	mA
R <sub>ON</sub>	Series resistance of the TCS™ device	TCS-DL004-250-WH TCS-DL004-500-WH TCS-DL004-750-WH	1.6 1.0 0.7	2.3 1.4 1.0	3.0 1.8 1.3	Ω
ΔRON	Channel to channel resistance match	TCS-DL004-250-WH TCS-DL004-500-WH TCS-DL004-750-WH			±0.05 ±0.03 ±0.02	Ω
t <sub>limit</sub>	Time for the device to go from normal operating state to current limiting state			50		ns
R <sub>θJA</sub>	Junction to air thermal resistance, FR4 PCB. 0.035 sq. in. of copper in addition to solder pads			130		°C/W

**BOURNS®**

**Asia-Pacific:** Tel: +886-2 2562-4117 • Fax: +886-2 2562-4116

**EMEA:** Tel: +36 88 520 390 • Fax: +36 88 520 211

**The Americas:** Tel: +1-951 781-5500 • Fax: +1-951 781-5700

[www.bourns.com](http://www.bourns.com)

\* RoHS Directive 2002/95/EC Jan. 27, 2003 including annex and RoHS Recast 2011/65/EU June 8, 2011.

\*\* Bourns follows the prevailing definition of "halogen free" in the industry. Bourns considers a product to be "halogen free" if (a) the Bromine (Br) content is 900 ppm or less; (b) the Chlorine (Cl) content is 900 ppm or less; and (c) the total Bromine (Br) and Chlorine (Cl) content is 1500 ppm or less.

Specifications are subject to change without notice.

The device characteristics and parameters in this data sheet can and do vary in different applications and actual device performance may vary over time.

Users should verify actual device performance in their specific applications.

## Performance Graphs

Graph 1 below shows a normalized Typical V-I curve for Bourns® TCS™ DL Series High-Speed Protector products under surge conditions. Graphs 2 and 3 show the change in resistance and trip current versus temperature, respectively.

### Normalized V-I Curve Under Surge Conditions

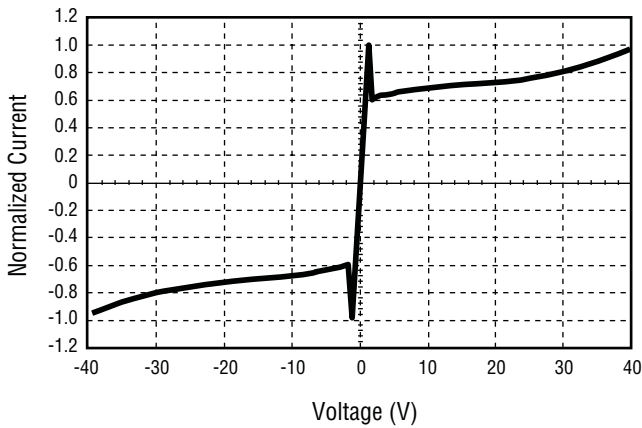

### Resistance Change vs. Temperature

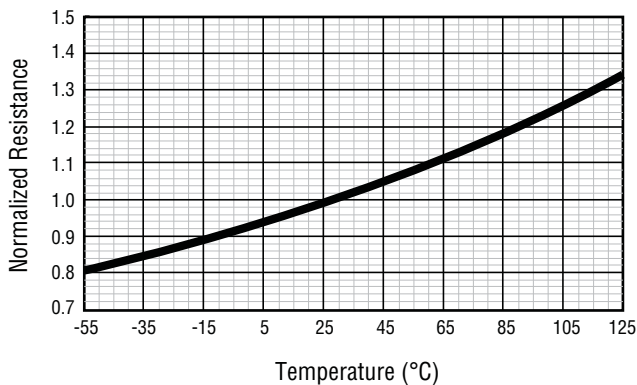

### Trip Current Change vs. Temperature

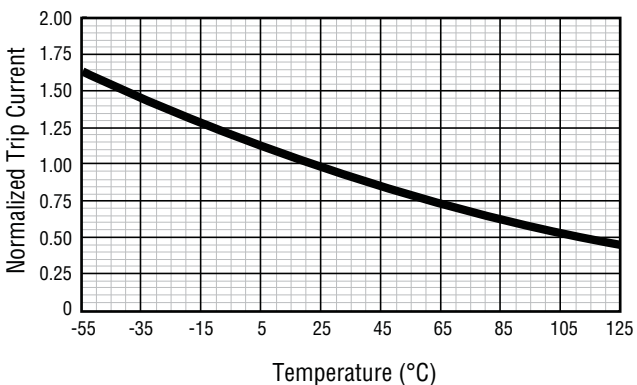

## Basic Device Operation

### SURGE PROTECTION

The Bourns® TCS™ High-Speed Protector is designed to be used in conjunction with a suitable overvoltage limiting device, such as a TVS diode or a TISP® thyristor as shown below, to provide comprehensive current and voltage limiting protection against surges.

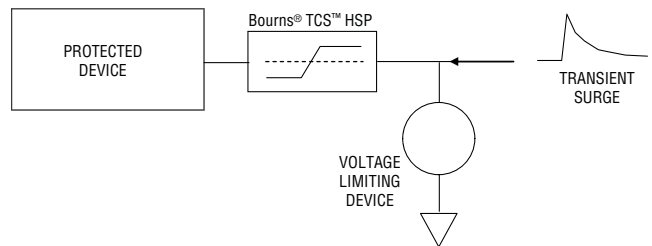

*Coordination of Bourns® TCS™ High-Speed Protector with Overvoltage Limiting Device*

This two-stage protection limits the maximum voltage at the interface to the clamping voltage of the overvoltage device, while also limiting the current into the protected device to the defined limit of the Bourns® TCS™ High-Speed Protector. Designers should choose a Bourns® TCS™ High-Speed Protector with a current limit that the protected device can handle for the duration of the surge event.

The Bourns® TCS™ High-Speed Protector acts like a low value resistor during normal operation. As the Bourns® TCS™ High-Speed Protector has no electrical connection to anything other than the signal line it protects, the capacitance to ground is purely dictated by the capacitance of the device to surrounding components and PCB traces, which with careful layout can be kept to an absolute minimum.

The Bourns® TCS™ High-Speed Protector can block voltages up to 40 V. This enables very low voltage electronics to be protected by a lower capacitance, higher voltage TVS device, thus achieving very low capacitive loading on high-speed signal lines. For example, on a 3.3 V driver, a 12 V rated TVS may be used, having much lower and more linear capacitance than a lower voltage type. Even though a high voltage TVS is used, the maximum stress seen by the protected device is much lower than would be seen by using a low voltage TVS by itself, as the current is limited to within the maximum limits of the Bourns® TCS™ High-Speed Protector.

The Bourns® TCS™ High-Speed Protector is primarily designed to offer superior and cost-effective protection of sensitive electronics against high energy surges that are transient in nature. Unlike the more complex TBU® High-Speed Protector device, the TCS™ Protector does not exhibit a strong foldback

Specifications are subject to change without notice. The device characteristics and parameters in this data sheet can and do vary in different applications and actual device performance may vary over time. Users should verify actual device performance in their specific applications.

**Basic Device Operation (Continued)**

characteristic after reaching the current limit, and therefore doesn't protect against DC and low frequency stresses (typically achieved through the use of a transformer or capacitive coupling). This is analogous to comparing the shunting characteristics of a Transient Voltage Suppressor device to a thyristor type of protector, such as Bourns® TISP® devices. Both the Bourns® TCS™ High-Speed Protector and TVS

device have limited or no foldback characteristic, and therefore have relatively low short term surge energy limits. When used together in a protection circuit, the surge must not exceed the thermal capability of either device. The following three graphs show the maximum surge duration with respect to voltage of the three TCS-DL devices at both +25 °C and +85 °C.

**TCS-DL004-250-WH SOA Single Surge Duration**

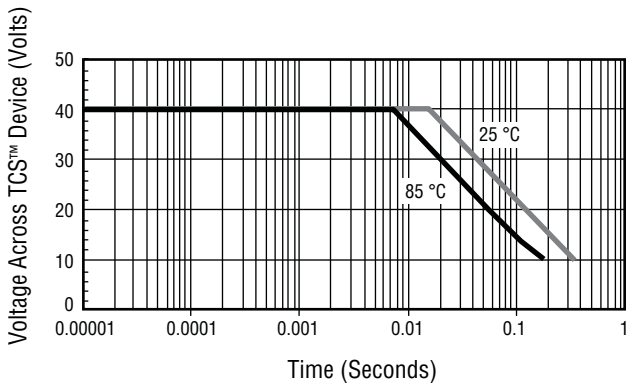

**TCS-DL004-750-WH SOA Single Surge Duration**

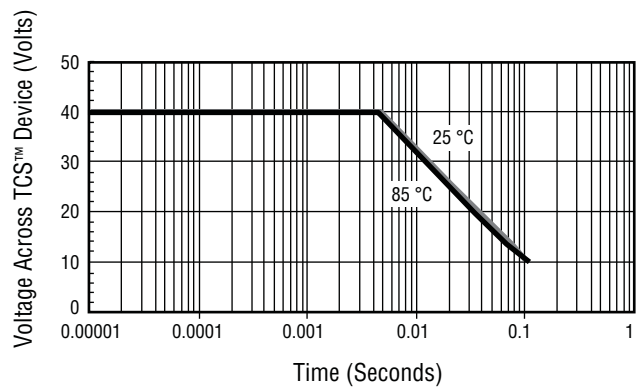

**TCS-DL004-500-WH SOA Single Surge Duration**

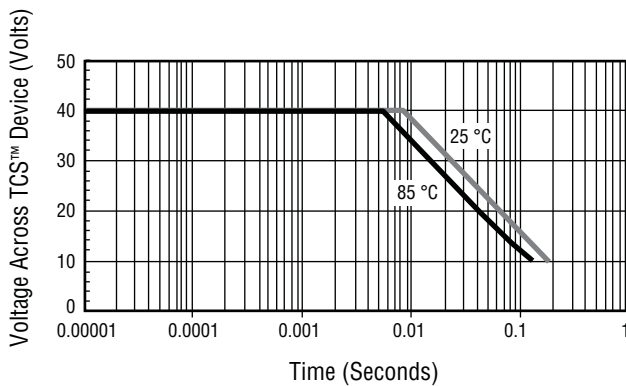

Specifications are subject to change without notice.  
 The device characteristics and parameters in this data sheet can and do vary in different applications and actual device performance may vary over time.  
 Users should verify actual device performance in their specific applications.

## Basic Device Operation (Continued)

### COORDINATION

In all applications, the overvoltage protection device should be chosen to limit the maximum voltage across the Bourns® TCS™ High-Speed Protector to less than the maximum voltage rating of the device. If this maximum voltage limit is exceeded, the Bourns® TCS™ High-Speed Protector may begin to avalanche, and it will cease to effectively block the current into the protected device, which may result in damage.

### USING MULTIPLE TCS-DL DEVICES IN SERIES OR PARALLEL

Bourns® TCS™ High-Speed Protectors may be connected in parallel to achieve even lower on-state resistance. If matching is required, use two Bourns® TCS-DL Series HSPs, and connect one Bourns® TCS™ High-Speed Protector from each DL device in parallel. In addition, because of their ultra-fast response, multiple Bourns® TCS™ High-Speed Protectors may be connected in series to achieve multiples of the breakdown voltage.

## Reference Applications

Two good examples of applications where the combination of a Bourns® TCS™ High-Speed Protector and a voltage limiting device provides exceptional performance are in VDSL

and Ethernet circuits, where the line is driven differentially by a transformer.

### VDSL

In the VDSL application shown below, the transformer provides additional protection against sustained DC faults and the coupling capacitors, C1 and C2, provide protection against DC and mains frequency power faults. The termination resistors

R1 and R2 are reduced in value by the nominal resistance of the Bourns® TCS™ High-Speed Protector to maintain the overall termination resistance.

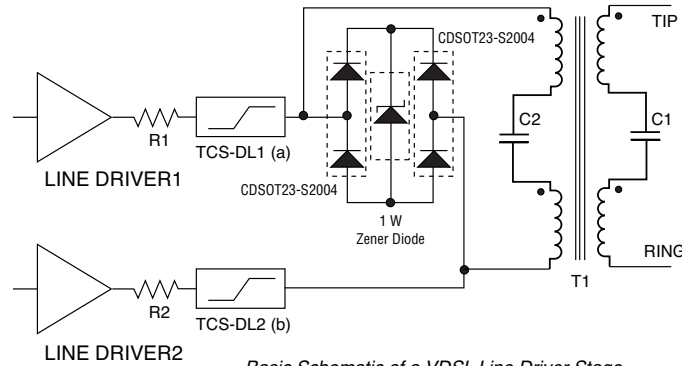

Basic Schematic of a VDSL Line Driver Stage

### GbE

In the Gigabit Ethernet (GbE) application circuit shown below, the transformer provides additional protection against sustained DC faults and provides some isolation from surge conditions such as lightning strikes. The TCS™ device limits the current that the PHY will be subjected to under a surge condition. It also provides voltage isolation so that the peak voltage that the

PHY is subjected to will be lower than the TVS diode clamp voltage. The TVS diode will sink the majority of the transformer secondary current and clamp the voltage to a level that is below the 40 V maximum rating of the TCS™ device.

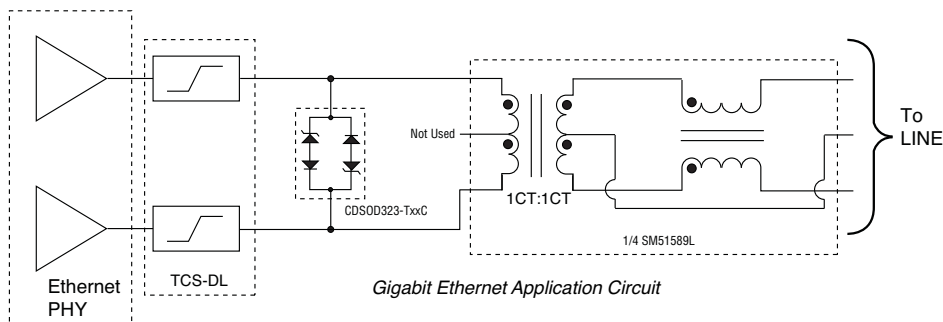

Gigabit Ethernet Application Circuit

# TCS-DL Series - TCS™ Dual Transient Current Suppressors

**BOURNS®**

## Product Dimensions

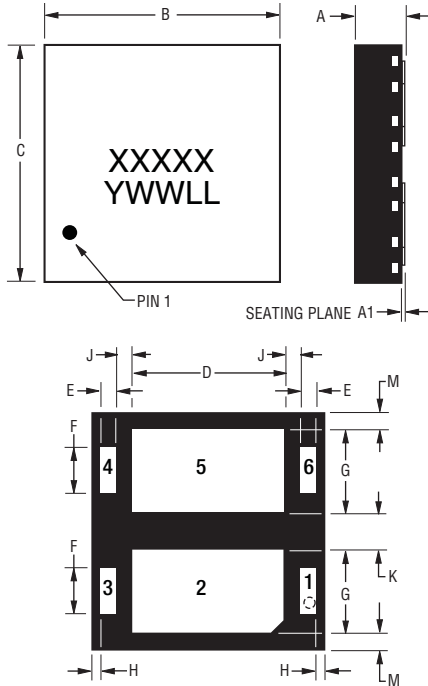

## Recommended Pad Layout

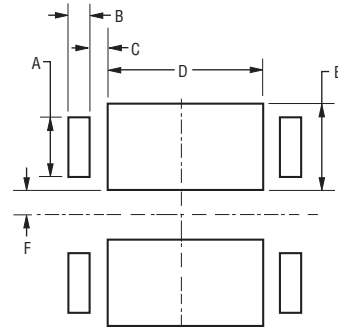

Dim.	TCS-DL004-250-WH	TCS-DL004-500-WH	TCS-DL004-750-WH
A	0.80 (.031)	0.80 (.031)	0.80 (.031)
B	0.25 (.010)	0.25 (.010)	0.25 (.010)
C	0.30 (.012)	0.30 (.012)	0.30 (.012)
D	1.1 (.043)	2.1 (.083)	3.1 (.122)
E	1.45 (.057)	1.45 (.057)	1.45 (.057)
F	0.30 (.012)	0.30 (.012)	0.30 (.012)

Dim.	TCS-DL004-250-WH			TCS-DL004-500-WH			TCS-DL004-750-WH		
	Min.	Typ.	Max.	Min.	Typ.	Max.	Min.	Typ.	Max.
A	0.80 (.031)	0.90 (.035)	1.00 (.039)	0.80 (.031)	0.90 (.035)	1.00 (.039)	0.80 (.031)	0.90 (.035)	1.00 (.039)
A1	0.00 (.000)	0.025 (.001)	0.05 (.002)	0.00 (.000)	0.025 (.001)	0.05 (.002)	0.00 (.000)	0.025 (.001)	0.05 (.002)
B	2.40 (.094)	2.50 (.098)	2.60 (.102)	3.4 (.134)	3.5 (.138)	3.6 (.142)	4.4 (.173)	4.5 (.177)	4.6 (.181)
C	3.90 (.154)	4.00 (.157)	4.10 (.161)	3.90 (.154)	4.00 (.157)	4.10 (.161)	3.90 (.154)	4.00 (.157)	4.10 (.161)
D	1.05 (.041)	1.10 (.043)	1.15 (.045)	2.05 (.081)	2.10 (.083)	2.15 (.085)	3.05 (.120)	3.10 (.122)	3.15 (.124)
E	0.20 (.008)	0.25 (.010)	0.30 (.012)	0.20 (.008)	0.25 (.010)	0.30 (.012)	0.20 (.008)	0.25 (.010)	0.30 (.012)
F	0.75 (.030)	0.8 (.031)	0.85 (.033)	0.75 (.030)	0.8 (.031)	0.85 (.033)	0.75 (.030)	0.8 (.031)	0.85 (.033)
G	1.40 (.055)	1.45 (.057)	1.50 (.059)	1.40 (.055)	1.45 (.057)	1.50 (.059)	1.40 (.055)	1.45 (.057)	1.50 (.059)
H	0.10 (.004)	0.15 (.006)	0.20 (.008)	0.10 (.004)	0.15 (.006)	0.20 (.008)	0.10 (.004)	0.15 (.006)	0.20 (.008)
J	0.25 (.010)	0.30 (.012)	0.35 (.014)	0.25 (.010)	0.30 (.012)	0.35 (.014)	0.25 (.010)	0.30 (.012)	0.35 (.014)
K	0.55 (.022)	0.60 (.024)	0.65 (.026)	0.55 (.022)	0.60 (.024)	0.65 (.026)	0.55 (.022)	0.60 (.024)	0.65 (.026)
M	0.20 (.008)	0.25 (.010)	0.30 (.012)	0.20 (.008)	0.25 (.010)	0.30 (.012)	0.20 (.008)	0.25 (.010)	0.30 (.012)

## Pad Designation

Pad #	Apply	Pad #	Apply
1	In1	4	Out2
2	NC	5	NC
3	Out1	6	In2

NC = Solder to PCB; do not make electrical connection, do not connect to ground.

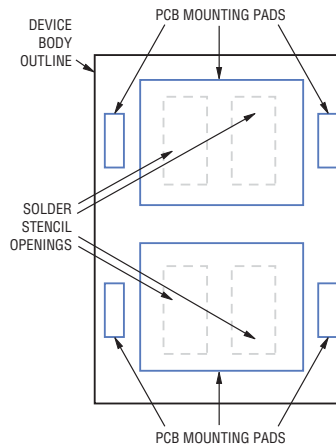

Bourns® TCS™ High-Speed Protectors have a matte-tin termination. The recommended solder stencil thickness is 0.10 to 0.12 mm (0.004 to 0.005 in.). The stencil opening for pins 1,3,4 and 6 should be the same size as the recommended PCB pad size. The stencil openings for pins 2 and 5 of the device should cover 60-70 % of the area of the PCB pad and should be divided into smaller areas as shown in the solder stencil figure.

DIMENSIONS:  $\frac{\text{MM}}{\text{(INCHES)}}$

Specifications are subject to change without notice. The device characteristics and parameters in this data sheet can and do vary in different applications and actual device performance may vary over time. Users should verify actual device performance in their specific applications.

# TCS-DL Series - TCS™ Dual Transient Current Suppressors

**BOURNS®**

## How to Order

**TCS - DL 004 - 500 - WH**

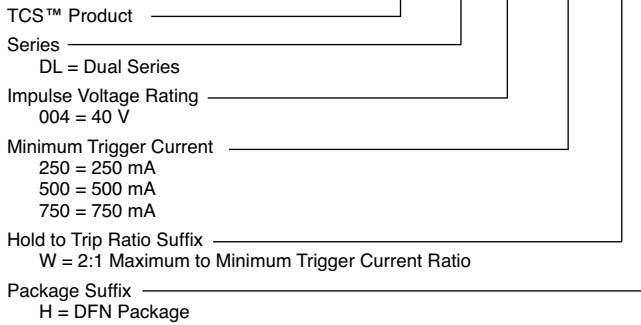

## Typical Part Marking

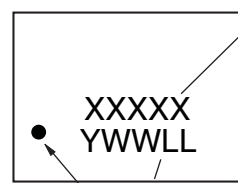

- 5 DIGIT PRODUCT CODE:
- 1ST ALPHA CHARACTER INDICATES PRODUCT FAMILY:  
D = TCS-DL SERIES
  - 2ND & 3RD DIGITS INDICATE IMPULSE VOLTAGE.
  - 4TH & 5TH DIGITS INDICATE TRIGGER CURRENT.

- MANUFACTURING DATE CODE:
- 1ST DIGIT INDICATES THE YEAR.
  - 2ND & 3RD DIGITS INDICATE THE WEEK NUMBER.
  - 4TH & 5TH DIGITS INDICATE LOT CODE.

# TCS-DL Series - TCS™ Dual Transient Current Suppressors



## Packaging Specifications

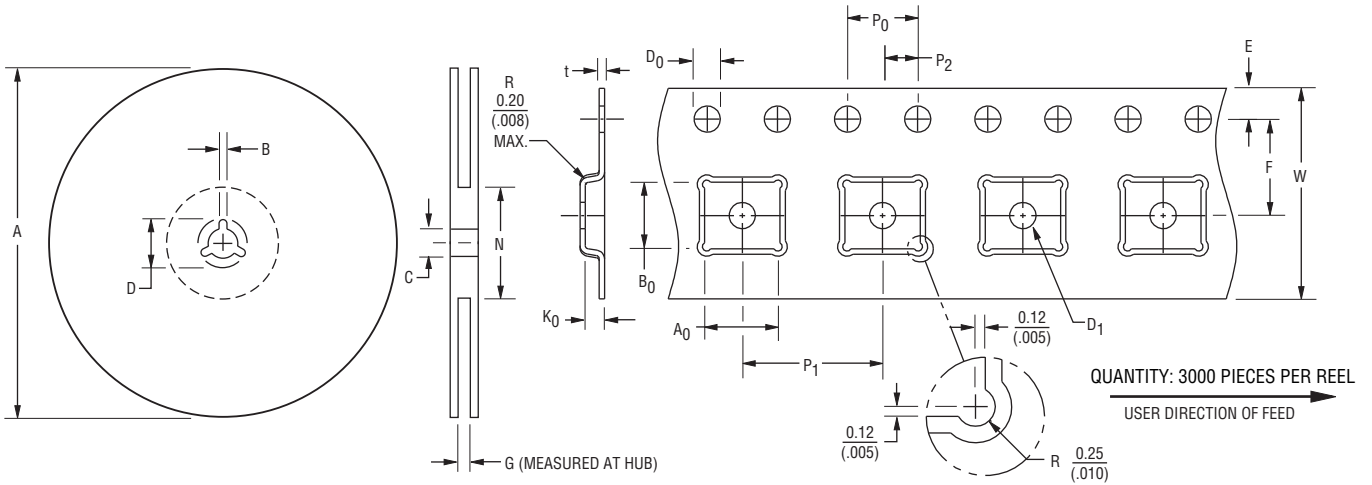

QUANTITY: 3000 PIECES PER REEL  
USER DIRECTION OF FEED

A		B		C		D		G	
Min.	Max.	Min.	Max.	Min.	Max.	Min.	Max.	Min.	Max.
326	330	1.5	2.5	12.8	13.5	20.2	—	12.4	14.4
(12.835)	(13.002)	(.059)	(.098)	(.504)	(.531)	(.795)		(.488)	(.567)

N		A0		D0		D1		E	
Ref.		Min.	Max.	Min.	Max.	Min.	Max.	Min.	Max.
100		4.20	4.40	1.50	1.60	1.50	-	1.65	1.85
(3.937)		(.165)	(.173)	(.059)	(.063)	(.059)		(.065)	(.073)

F		K0		P0		P1		P2	
Min.	Max.	Min.	Max.	Min.	Max.	Min.	Max.	Min.	Max.
5.45	5.55	1.00	1.20	3.90	4.10	7.90	8.10	1.95	2.05
(.215)	(.219)	(.039)	(.047)	(.154)	(.161)	(.311)	(.319)	(.077)	(.081)

t		W	
Min.	Max.	Min.	Max.
0.25	0.35	11.70	12.30
(.010)	(.014)	(.461)	(.484)

DIMENSIONS:  $\frac{\text{MM}}{\text{(INCHES)}}$

TCS-DL004-250-WH		TCS-DL004-500-WH		TCS-DL004-750-WH	
B0					
Min.	Max.	Min.	Max.	Min.	Max.
2.70	2.90	3.70	3.90	4.70	4.90
(.106)	(.114)	(.146)	(.154)	(.185)	(.193)

REV. 12/15

"TBU" is a registered trademark of Bourns, Inc. in the United States and other countries.

"TCS" is a trademark of Bourns, Inc.

"TISP" is a registered trademark of Bourns Ltd., a Bourns Company, in the United States and other countries, except that "TISP" is a registered trademark of Bourns, Inc. in China.

Specifications are subject to change without notice.

The device characteristics and parameters in this data sheet can and do vary in different applications and actual device performance may vary over time.

Users should verify actual device performance in their specific applications.