



# Dual 1.1Gbps Pin Electronics with Integrated PMU and Level-Setting DACs

MAX9979

## General Description

The MAX9979 fully integrated, high-performance, dual-channel pin electronics integrates multiple automatic test equipment (ATE) functions into a single IC, including driver/comparator/load (DCL), parametric measurement unit (PMU), and built-in (16-bit) level-setting digital-to-analog converters (DACs). The device is ideal for memory and SOC tester applications. Each channel includes a four-level pin driver, window comparator, differential comparator, dynamic clamps, a versatile PMU, an active load, a high-voltage (VHH) programmable level, and 14 independent level-setting DACs. The MAX9979 features programmable cable-droop compensation for the driver output and for the comparator input, adjustable driver output resistance that allows optimal performance over typical data-path transmission-line variations, slew-rate adjustment, and a programmable high-voltage driver output.

The MAX9979 driver features a wide 8V (-1.5V to +6.5V) high-speed operating voltage range and a VHH programmable range of up to +13V. Operation modes include high-impedance, active-termination (3rd-level drive) and VHH (4th-level drive) modes. The device is highly linear even at low voltage swings. The driver provides high-speed differential control inputs compatible with most high-speed logic families. The window comparators provide extremely low timing variation over changes in slew rate, pulse width, and overdrive voltage. In high-impedance mode, the MAX9979 features dynamic clamps that dampen high-speed device-under-test (DUT) waveforms. The 20mA active load facilitates fast contact testing when used in conjunction with the comparators, and functions as a pullup/pulldown for open-drain/collector DUT outputs. The PMU offers five current ranges from  $\pm 2\mu\text{A}$  to  $\pm 50\text{mA}$  and can force and measure current or voltage. An SPI™-compatible serial interface configures the MAX9979.

The MAX9979 is available in a small footprint, 68-pin (10mm x 10mm x 1mm) TQFN-EP-IDP package with exposed pad on the top for easy heat removal. Power dissipation is 1.2W per channel (typ) over the full operating voltage range with the active load disabled. The MAX9979 operates over an internal die temperature range of +40°C to +100°C and provides a temperature monitor output.

## Applications

Memory ATE Testers  
SOC ATE Testers

SPI is a trademark of Motorola, Inc.



Maxim Integrated Products 1

For pricing, delivery, and ordering information, please contact Maxim Direct at 1-888-629-4642, or visit Maxim's website at [www.maxim-ic.com](http://www.maxim-ic.com).

## Features

- ◆ High Speed: 1.1Gbps at 1V<sub>p-p</sub>
- ◆ Extremely Low Power Dissipation: 1.2W/Channel (Active Load Disabled)
- ◆ Wide Voltage Range: -1.5V to +6.5V and Up to 13V VHH
- ◆ Wide Voltage Swing Range: 50mV<sub>p-p</sub> to 13V<sub>p-p</sub>
- ◆ Low-Leak Mode: 10nA max
- ◆ Integrated Termination-on-the-Fly (3rd-Level Drive)
- ◆ Integrated VHH High Voltage (4th-Level Drive)
- ◆ Integrated Voltage Clamps
- ◆ Integrated 20mA Active Load
- ◆ Integrated Per-Pin PMU
- ◆ Integrated Level-Setting CALDACs
- ◆ Programmable Cable-Droop Compensation for Both Driver Output and Comparator Input
- ◆ Programmable Driver Output Impedance
- ◆ Four Slew-Rate Settings for Driver Output
- ◆ Analog Measure Bus
- ◆ Very Low Timing Dispersion
- ◆ Minimal External Component Count
- ◆ SPI-Compatible Serial Control Interface
- ◆ 68-Pin Thermally Enhanced TQFN Package with Top-Side Heat Removal

## Ordering Information

PART	TEMP RANGE	PIN-PACKAGE
MAX9979KCTK+	0°C to +70°C	68 TQFN-EP-IDP*

+Denotes a lead(Pb)-free/RoHS-compliant package.

\*EP-IDP = Exposed pad, inverted die pad.

Pin Configuration and Typical Operating Circuit appear at end of data sheet.

# Dual 1.1Gbps Pin Electronics with Integrated PMU and Level-Setting DACs

## ABSOLUTE MAXIMUM RATINGS

V <sub>CC</sub> to GND	-0.3V to +11V
V <sub>EE</sub> to GND	-5.5V to +0.3V
V <sub>CC</sub> to V <sub>EE</sub>	-0.3V to +16.5V
V <sub>DD</sub> to DGND	-0.3V to +5.2V
V <sub>HHP</sub> to GND	-0.3V to +19V
DGND to GND	±0.3V
CTV <sub>-</sub> , BV <sub>-</sub> to GND	-0.3V to +5V
DATA <sub>-</sub> , NDATA <sub>-</sub> , RCV <sub>-</sub> , NRCV <sub>-</sub> to GND	(V <sub>EE</sub> - 0.3V) to (V <sub>BV<sub>-</sub></sub> + 0.3V)
CH <sub>-</sub> , NCH <sub>-</sub> , CL <sub>-</sub> , NCL <sub>-</sub> to GND	-1.5V to (V <sub>CTV<sub>-</sub></sub> + 0.3V)
Current into CH <sub>-</sub> , NCH <sub>-</sub> , CL <sub>-</sub> , NCL <sub>-</sub>	±35mA
DATA <sub>-</sub> to NDATA <sub>-</sub> , RCV <sub>-</sub> to NRCV <sub>-</sub>	±1V
DUT <sub>-</sub> , PMU-F, PMU-S, SENSE <sub>-</sub> to GND (non-V <sub>HHP</sub> mode)	(V <sub>EE</sub> - 0.3V) to (V <sub>CC</sub> + 0.3V)
DUT <sub>-</sub> , PMU-F, PMU-S, SENSE <sub>-</sub> to GND (V <sub>HHP</sub> mode)	-3.5V to +13.5V
SCLK, DIN, CS, RST, LOAD to GND	-0.3V to (V <sub>DD</sub> + 0.3V)
LLEAKP <sub>-</sub> , HIZMEASP <sub>-</sub> , ENVHHP <sub>-</sub> , DUTHI <sub>-</sub> , DUTLO <sub>-</sub> to GND	-0.3V to (V <sub>DD</sub> + 0.3V)

TEMP to GND	0 to V <sub>CC</sub>
MEAS <sub>-</sub> to GND	(V <sub>EE</sub> - 0.3V) to (V <sub>CC</sub> + 0.3V)
REF to GND	-0.3V to (2.6V + V <sub>DGS</sub> )
Current into SCLK, DIN, CS, RST, LOAD	±30mA
Current into LLEAKP <sub>-</sub> , HIZMEASP <sub>-</sub> , ENVHHP <sub>-</sub> , DUTHI <sub>-</sub> , DUTLO <sub>-</sub>	±30mA
PMU-F Continuous Current	±35mA
PMU-F Peak Current	±70mA
PMU-S Continuous Current	±1mA
PMU-S Peak Current	±20mA
DGS to GND	±0.3V
DUT <sub>-</sub> , SENSE <sub>-</sub> Short-Circuit Duration to V <sub>CC</sub> , V <sub>EE</sub>	Continuous
Power Dissipation (T <sub>A</sub> = +70°C)* MAX9979KCTK (derate 125mW/°C above +70°C)	10W
Storage Temperature Range	-65°C to +150°C
Maximum Junction Temperature	+150°C
Lead Temperature (soldering, 10s)	+300°C

\*Dissipation wattage values are based on still air with no heatsink. Actual maximum power dissipation is a function of heat extraction technique and may be substantially higher.

Stresses beyond those listed under "Absolute Maximum Ratings" may cause permanent damage to the device. These are stress ratings only, and functional operation of the device at these or any other conditions beyond those indicated in the operational sections of the specifications is not implied. Exposure to absolute maximum rating conditions for extended periods may affect device reliability.

## PACKAGE THERMAL CHARACTERISTICS\*\*

TQFN

Junction-to-Case Thermal Resistance (θ <sub>JA</sub> )	8.0°C/W
Junction-to-Ambient Thermal Resistance (θ <sub>JC</sub> )	0.3°C/W

\*\*Package thermal resistances were obtained using the method described in JEDEC specification JESD51-7, using a four-layer board. For detailed information on package thermal considerations, refer to [www.maxim-ic.com/thermal-tutorial](http://www.maxim-ic.com/thermal-tutorial).

## ELECTRICAL CHARACTERISTICS

(V<sub>CC</sub> = 9.75V, V<sub>EE</sub> = -4.75V, V<sub>DD</sub> = 3.3V, V<sub>HHP</sub> = 17.5V, V<sub>DHV<sub>-</sub></sub> = 3V, V<sub>DLV<sub>-</sub></sub> = 0V, V<sub>DTV<sub>-</sub></sub> = 1.5V, SC1 = SC0 = 0V, V<sub>C<sub>PHV<sub>-</sub></sub></sub> = 7.2V, V<sub>C<sub>PLV<sub>-</sub></sub></sub> = -2.2V, V<sub>CTV<sub>-</sub></sub> = 1.4V, V<sub>BV<sub>-</sub></sub> = 4V, V<sub>DGS</sub> = V<sub>GND</sub> = 0V, V<sub>CHV<sub>-</sub></sub> = V<sub>I<sub>V</sub>MAX<sub>-</sub></sub> = 2V, V<sub>C<sub>L</sub>V<sub>-</sub></sub> = V<sub>I<sub>V</sub>MIN<sub>-</sub></sub> = 1V, V<sub>COM<sub>-</sub></sub> = 2.5V, V<sub>L<sub>D</sub>HV<sub>-</sub></sub> = 0V, V<sub>L<sub>D</sub>LV<sub>-</sub></sub> = 0V, V<sub>I<sub>N</sub></sub> = 2.5V, V<sub>I<sub>O</sub>S</sub> = 0V, V<sub>I<sub>I</sub>O</sub>S = 2.5V, V<sub>C<sub>L</sub>AMP<sub>H</sub></sub> = 5V, V<sub>C<sub>L</sub>AMP<sub>L</sub></sub> = 0V, V<sub>H<sub>H</sub></sub> = 10V, C<sub>D<sub>R</sub>P</sub> = 0b001, R<sub>O</sub> = 0b1000, H<sub>Y</sub>ST = 0b000, Z<sub>L</sub>OAD = 50Ω, T<sub>J</sub> = +70°C to an accuracy of ±15°C, unless otherwise noted. All temperature coefficients are measured at T<sub>J</sub> = +40°C to +100°C, unless otherwise noted.) (Note 1)

PARAMETER	SYMBOL	CONDITIONS	MIN	TYP	MAX	UNITS
<b>DRIVER</b>						
<b>DC CHARACTERISTICS (R<sub>L</sub> ≥ 10MΩ, unless otherwise noted; includes DAC error)</b>						
Output-Voltage Range	V <sub>DHV</sub>	V <sub>DLV<sub>-</sub></sub> = -1.5V, V <sub>DTV<sub>-</sub></sub> = 1.5V	-1.45 to +6.50		V	
	V <sub>DLV</sub>	V <sub>DHV<sub>-</sub></sub> = 6.5V, V <sub>DTV<sub>-</sub></sub> = 1.5V	-1.50 to +6.45			
	V <sub>DTV</sub>	V <sub>DHV<sub>-</sub></sub> = 6.5V, V <sub>DLV<sub>-</sub></sub> = -1.5V (Note 2)	-1.50	+6.50		
Output Offset Voltage	V <sub>DHV</sub>	V <sub>DHV<sub>-</sub></sub> = 3V, V <sub>DLV<sub>-</sub></sub> = -1.5V, V <sub>DTV<sub>-</sub></sub> = 1.5V	±5		mV	
	V <sub>DLV</sub>	V <sub>DLV<sub>-</sub></sub> = 0V, V <sub>DHV<sub>-</sub></sub> = 6.5V, V <sub>DTV<sub>-</sub></sub> = 1.5V	±5			
	V <sub>DTV</sub>	V <sub>DTV<sub>-</sub></sub> = 1.5V, V <sub>DHV<sub>-</sub></sub> = 6.5V, V <sub>DLV<sub>-</sub></sub> = -1.5V	±5			
Output-Voltage Temperature Coefficient (Notes 3, 4)		DHV <sub>-</sub> , DLV <sub>-</sub> , DTV <sub>-</sub>	±75	±500		μV/°C

# Dual 1.1Gbps Pin Electronics with Integrated PMU and Level-Setting DACs

MAX9979

## ELECTRICAL CHARACTERISTICS (continued)

( $V_{CC} = 9.75V$ ,  $V_{EE} = -4.75V$ ,  $V_{DD} = 3.3V$ ,  $V_{HHP} = 17.5V$ ,  $V_{DHFV} = 3V$ ,  $V_{DLV} = 0V$ ,  $V_{DTV} = 1.5V$ ,  $SC1 = SC0 = 0V$ ,  $V_{CPHV} = 7.2V$ ,  $V_{CPLV} = -2.2V$ ,  $V_{CTV} = 1.4V$ ,  $V_{BV} = 4V$ ,  $V_{DGS} = V_{GND} = 0V$ ,  $V_{CHV} = V_{IVMAX} = 2V$ ,  $V_{CLV} = V_{IVMIN} = 1V$ ,  $V_{COM} = 2.5V$ ,  $V_{LDHFV} = 0V$ ,  $V_{LDLV} = 0V$ ,  $V_{IN} = 2.5V$ ,  $V_{VIOS} = 0V$ ,  $V_{VIOS} = 2.5V$ ,  $V_{CLAMPHI} = 5V$ ,  $V_{CLAMPLO} = 0V$ ,  $V_{HH} = 10V$ ,  $CDRP = 0b001$ ,  $RO = 0b1000$ ,  $HYST = 0b000$ ,  $Z_{LOAD} = 50\Omega$ ,  $T_J = +70^\circ C$  to an accuracy of  $\pm 15^\circ C$ , unless otherwise noted. All temperature coefficients are measured at  $T_J = +40^\circ C$  to  $+100^\circ C$ , unless otherwise noted.) (Note 1)

PARAMETER	SYMBOL	CONDITIONS		MIN	TYP	MAX	UNITS
Gain	ADHV <sub>-</sub>	V <sub>DLV</sub> <sub>-</sub> = -1.5V, V <sub>DTV</sub> <sub>-</sub> = 1.5V, V <sub>DHFV</sub> <sub>-</sub> = 0V and 4.5V		0.998	1	1.002	V/V
	ADLV	V <sub>DHFV</sub> <sub>-</sub> = 6.5V, V <sub>DTV</sub> <sub>-</sub> = 1.5V, V <sub>DLV</sub> <sub>-</sub> = 0V and 4.5V		0.998	1	1.002	
	ADTV	V <sub>DHFV</sub> <sub>-</sub> = 6.5V, V <sub>DLV</sub> <sub>-</sub> = -1.5V, V <sub>DTV</sub> <sub>-</sub> = 0V and 4.5V		0.998	1	1.002	
Linearity Error	0 to 3V relative to calibration points at 0 and 3V		V <sub>DLV</sub> <sub>-</sub> = -1.5V, V <sub>DTV</sub> <sub>-</sub> = 1.5V, V <sub>DHFV</sub> <sub>-</sub> = 0V, 0.75V, 1.5V, 2.25V, 3V			±2	mV
			V <sub>DHFV</sub> <sub>-</sub> = 6.5V, V <sub>DTV</sub> <sub>-</sub> = 1.5V, V <sub>DLV</sub> <sub>-</sub> = 0V, 0.75V, 1.5V, 2.25V, 3V			±2	
			V <sub>DLV</sub> <sub>-</sub> = -1.5V, V <sub>DHFV</sub> <sub>-</sub> = 6.5V, V <sub>DTV</sub> <sub>-</sub> = 0V, 0.75V, 1.5V, 2.25V, 3V			±2	
	-1V to 6V relative to calibration points at 0 and 3V		V <sub>DLV</sub> <sub>-</sub> = -1.5V, V <sub>DTV</sub> <sub>-</sub> = 1.5V, V <sub>DHFV</sub> <sub>-</sub> = -1V and 6V			±4.5	
			V <sub>DHFV</sub> <sub>-</sub> = 6.5V, V <sub>DTV</sub> <sub>-</sub> = 1.5V, V <sub>DLV</sub> <sub>-</sub> = -1V and 6V			±4.5	
			V <sub>DLV</sub> <sub>-</sub> = -1.5V, V <sub>DHFV</sub> <sub>-</sub> = 6.5V, V <sub>DTV</sub> <sub>-</sub> = -1V and 6V			±4.5	
	Full range relative to calibration points at 0 and 3V		V <sub>DLV</sub> <sub>-</sub> = -1.5V, V <sub>DTV</sub> <sub>-</sub> = 1.5V, V <sub>DHFV</sub> <sub>-</sub> = -1.25V and 6.5V			±6	
			V <sub>DHFV</sub> <sub>-</sub> = 6.5V, V <sub>DTV</sub> <sub>-</sub> = 1.5V, V <sub>DLV</sub> <sub>-</sub> = -1.5V and 6.25V			±6	
			V <sub>DLV</sub> <sub>-</sub> = -1.5V, V <sub>DHFV</sub> <sub>-</sub> = 6.5V, V <sub>DTV</sub> <sub>-</sub> = -1.5V and 6.5V			±6	

# Dual 1.1Gbps Pin Electronics with Integrated PMU and Level-Setting DACs

## ELECTRICAL CHARACTERISTICS (continued)

( $V_{CC} = 9.75V$ ,  $V_{EE} = -4.75V$ ,  $V_{DD} = 3.3V$ ,  $V_{HHP} = 17.5V$ ,  $V_{DHFV} = 3V$ ,  $V_{DLV} = 0V$ ,  $V_{DTV} = 1.5V$ ,  $SC1 = SC0 = 0V$ ,  $V_{CPHV} = 7.2V$ ,  $V_{CPLV} = -2.2V$ ,  $V_{CTV} = 1.4V$ ,  $V_{BV} = 4V$ ,  $V_{DGS} = V_{GND} = 0V$ ,  $V_{CHV} = V_{IVMAX} = 2V$ ,  $V_{CLV} = V_{IVMIN} = 1V$ ,  $V_{COM} = 2.5V$ ,  $V_{LDHV} = 0V$ ,  $V_{LDLV} = 0V$ ,  $V_{IN} = 2.5V$ ,  $V_{VIOS} = 0V$ ,  $V_{VIOS} = 2.5V$ ,  $V_{CLAMPHI} = 5V$ ,  $V_{CLAMPLO} = 0V$ ,  $V_{HH} = 10V$ ,  $CDRP = 0b001$ ,  $RO = 0b1000$ ,  $HYST = 0b000$ ,  $Z_{LOAD} = 50\Omega$ ,  $T_J = +70^\circ C$  to an accuracy of  $\pm 15^\circ C$ , unless otherwise noted. All temperature coefficients are measured at  $T_J = +40^\circ C$  to  $+100^\circ C$ , unless otherwise noted.) (Note 1)

PARAMETER	SYMBOL	CONDITIONS	MIN	TYP	MAX	UNITS	
Crosstalk		DHV_ to DLV_	$V_{DLV} = 0V$ , $V_{DTV} = 1.5V$ , $V_{DHFV} = 0.2V$ and $6.5V$			$\pm 7$	mV
		DLV_ to DHV_	$V_{DHFV} = 5V$ , $V_{DTV} = 1.5V$ , $V_{DLV} = -1.5$ and $4.8V$			$\pm 7$	
		DTV_ to DLV_ and DHV_	$V_{DHFV} = 3V$ , $V_{DLV} = 0V$ , $V_{DTV} = -1.5V$ and $6.5V$			$\pm 2$	
		DHV_ to DTV_	$V_{DTV} = 1.5V$ , $V_{DLV} = 0V$ , $V_{DHFV} = 1.6V$ and $3V$			$\pm 3$	
		DLV_ to DTV_	$V_{DTV} = 1.5V$ , $V_{DHFV} = 3V$ , $V_{DLV} = 0$ and $1.4V$			$\pm 3$	
Term Voltage		Dependence on DATA_	$V_{DTV} = 1.5V$ , $V_{DHFV} = 3V$ , $V_{DLV} = 0V$ , DATA_ = 0 and 1			$\pm 2$	mV
DC Power-Supply Rejection (Note 5)		DHV_	$V_{DHFV} = 3V$	40			dB
		DLV_	$V_{DLV} = 0V$	40			
		DTV_	$V_{DTV} = 1.5V$	40			
DC Drive Current Limit		$V_{DHFV} = 6.5V$ , $V_{DLV} = -1.5V$	DATA_ = 1, $V_{DUT} = -1.5V$	+60		+110	mA
			DATA_ = 0, $V_{DUT} = 6.5V$	-110		-60	
DC Output Resistance		(Note 6)	48	50	52	$\Omega$	
DC Output Resistance Variation (Note 7)		DATA_ = 1, $V_{DHFV} = 3V$ , $V_{DLV} = 0V$ , $V_{DTV} = 1.5V$ , $I_{DUT} = 1mA, 8mA, 15mA, 40mA$		1		2	$\Omega$
		DATA_ = 0, $V_{DHFV} = 3V$ , $V_{DLV} = 0V$ , $V_{DTV} = 1.5V$ , $I_{DUT} = -1mA, -8mA, -15mA, -40mA$		1		2	
Adjustable Output Resistance Range		$R_O = 0xF$ vs. $R_O = 0x8$ and $R_O = 0x0$ vs. $R_O = 0x8$ , resolution of $0.36\Omega$ (Note 6)		$\pm 2.5$		$\Omega$	

# Dual 1.1Gbps Pin Electronics with Integrated PMU and Level-Setting DACs

MAX9979

## ELECTRICAL CHARACTERISTICS (continued)

( $V_{CC} = 9.75V$ ,  $V_{EE} = -4.75V$ ,  $V_{DD} = 3.3V$ ,  $V_{HHP} = 17.5V$ ,  $V_{DHFV} = 3V$ ,  $V_{DLV} = 0V$ ,  $V_{DTV} = 1.5V$ ,  $SC1 = SC0 = 0V$ ,  $V_{CPHV} = 7.2V$ ,  $V_{CPLV} = -2.2V$ ,  $V_{CTV} = 1.4V$ ,  $V_{BV} = 4V$ ,  $V_{DGS} = V_{GND} = 0V$ ,  $V_{CHV} = V_{IVMAX} = 2V$ ,  $V_{CLV} = V_{IVMIN} = 1V$ ,  $V_{COM} = 2.5V$ ,  $V_{LDHFV} = 0V$ ,  $V_{LDLV} = 0V$ ,  $V_{IN} = 2.5V$ ,  $V_{VLOS} = 0V$ ,  $V_{VLOS} = 2.5V$ ,  $V_{CLAMPHI} = 5V$ ,  $V_{CLAMPLO} = 0V$ ,  $V_{HH} = 10V$ ,  $CDRP = 0b001$ ,  $RO = 0b1000$ ,  $HYST = 0b000$ ,  $Z_{LOAD} = 50\Omega$ ,  $T_J = +70^\circ C$  to an accuracy of  $\pm 15^\circ C$ , unless otherwise noted. All temperature coefficients are measured at  $T_J = +40^\circ C$  to  $+100^\circ C$ , unless otherwise noted.) (Note 1)

PARAMETER	SYMBOL	CONDITIONS	MIN	TYP	MAX	UNITS	
<b>AC CHARACTERISTICS (<math>R_{DUT} = 50\Omega</math> to Ground) (Note 8)</b>							
Dynamic Drive Current		(Note 9)		$\pm 130$		mA	
Drive-Mode Overshoot		Cable-droop compensation off, $V_{DLV} = 0V$ , $V_{DHFV} = 0.1V$		30		mV	
		Cable-droop compensation off, $V_{DLV} = 0V$ , $V_{DHFV} = 1V$		40			
		Cable-droop compensation off, $V_{DLV} = 0V$ , $V_{DHFV} = 3V$		50			
		Cable-droop compensation off, $V_{DLV} = 0V$ , $V_{DHFV} = 5V$		50			
Cable-Droop Compensation		$V_{DLV} = 0V$ , $V_{DHFV} = 3V$ , $CDRP = 0b000$		0		%	
		$V_{DLV} = 0V$ , $V_{DHFV} = 3V$ , $CDRP = 0b111$		10			
Termination-Mode Overshoot		Cable-droop compensation off (Note 10)		0		mV	
Settling Time (Notes 4, 11)		To within 100mV, $V_{DHFV} = 5V$ , $V_{DLV} = 0V$		0.25	1	ns	
		To within 50mV, $V_{DHFV} = 3V$ , $V_{DLV} = 0V$		0.25	1		
		To within 50mV, $V_{DHFV} = 0.5V$ , $V_{DLV} = 0V$		0.25	1		
<b>TIMING CHARACTERISTICS (Notes 8, 12)</b>							
Propagation Delay		Data to output, $V_{DHFV} = 3V$ , $V_{DLV} = 0V$ (Note 13)		1	1.9	4	ns
		Drive to term, term to drive (Notes 4, 14)		1.7	2.7	3.7	
		Drive to high impedance, high impedance to drive, $V_{DHFV} = 1V$ , $V_{DLV} = -1V$ (Notes 4, 15)		1.4	2.4	3.4	
Propagation-Delay Match		$t_{LH}$ vs. $t_{HL}$ (Note 4)		$\pm 40$	$\pm 80$	ps	
		Drivers within package, same edge		$\pm 40$			
		Drive to high impedance vs. high impedance to drive, $V_{DHFV} = 1V$ , $V_{DLV} = -1V$ (Note 16)		$\pm 0.5$		ns	
		High impedance vs. data		$\pm 0.5$			
		Drive to term vs. term to drive, $V_{DHFV} = 3V$ , $V_{DLV} = 0V$ , $V_{DTV} = 1.5V$ (Note 17)		$\pm 0.3$			
		Terminate vs. data		$\pm 0.8$			
Propagation-Delay Channel Match		Differential mode, $V_{DHFV} = 1V$ , $V_{DLV} = 0V$ , channel 1 inverted, DIFFERENTIAL0 = 1, INVERT1 = 1		$\pm 40$		ps	

# Dual 1.1Gbps Pin Electronics with Integrated PMU and Level-Setting DACs

## ELECTRICAL CHARACTERISTICS (continued)

( $V_{CC} = 9.75V$ ,  $V_{EE} = -4.75V$ ,  $V_{DD} = 3.3V$ ,  $V_{HHP} = 17.5V$ ,  $V_{DHFV} = 3V$ ,  $V_{DLV} = 0V$ ,  $V_{DTV} = 1.5V$ ,  $SC1 = SC0 = 0V$ ,  $V_{CPHV} = 7.2V$ ,  $V_{CPLV} = -2.2V$ ,  $V_{CTV} = 1.4V$ ,  $V_{BV} = 4V$ ,  $V_{DGS} = V_{GND} = 0V$ ,  $V_{CHV} = V_{VIMAX} = 2V$ ,  $V_{CLV} = V_{VIMIN} = 1V$ ,  $V_{COM} = 2.5V$ ,  $V_{LDHFV} = 0V$ ,  $V_{LDLV} = 0V$ ,  $V_{IN} = 2.5V$ ,  $V_{VIOS} = 0V$ ,  $V_{VIOS} = 2.5V$ ,  $V_{CLAMPHI} = 5V$ ,  $V_{CLAMPLO} = 0V$ ,  $V_{HH} = 10V$ ,  $CDRP = 0b001$ ,  $RO = 0b1000$ ,  $HYST = 0b000$ ,  $Z_{LOAD} = 50\Omega$ ,  $T_J = +70^\circ C$  to an accuracy of  $\pm 15^\circ C$ , unless otherwise noted. All temperature coefficients are measured at  $T_J = +40^\circ C$  to  $+100^\circ C$ , unless otherwise noted.) (Note 1)

PARAMETER	SYMBOL	CONDITIONS	MIN	TYP	MAX	UNITS
Propagation-Delay Temperature Coefficient		$V_{DHFV} = 3V$ , $V_{DLV} = 0V$ (Note 4)		3	5	ps/ $^\circ C$
Propagation-Delay Change		$V_{DHFV} = 1V$ , $V_{DLV} = 0V$ , 1ns to 24ns pulse width (Note 4)		$\pm 25$	$\pm 60$	ps
		$V_{DHFV} = 3V$ , $V_{DLV} = 0V$ , 1ns to 24ns pulse width (Note 4)		$\pm 35$	$\pm 60$	
		$V_{DHFV} = 5V$ , $V_{DLV} = 0V$ , 1.5ns to 23.5ns pulse width		$\pm 100$		
		Peak-to-peak change vs. common mode, $V_{DHFV} - V_{DLV} = 1V$ , $V_{DHFV} = 0$ to 6V, using a DC-blocking capacitor (Note 4)		50	60	
Rise-and-Fall Time		0.2V <sub>P-P</sub> programmed, $V_{DHFV} = 0.2V$ , $V_{DLV} = 0V$ , 20% to 80%		275		ps
		1V <sub>P-P</sub> programmed, $V_{DHFV} = 1V$ , $V_{DLV} = 0V$ , 10% to 90%	330	450	550	
		3V <sub>P-P</sub> programmed, $V_{DHFV} = 3V$ , $V_{DLV} = 0V$ , 10% to 90%, trim condition	500	650	800	
		5V <sub>P-P</sub> programmed, $V_{DHFV} = 5V$ , $V_{DLV} = 0V$ , 10% to 90% (Note 4)	800	1000	1200	
Rise-and-Fall Time Matching		0.2V <sub>P-P</sub> programmed, $V_{DHFV} = 0.2V$ , $V_{DLV} = 0V$ , 20% to 80%		$\pm 40$		ps
		1V <sub>P-P</sub> programmed, $V_{DHFV} = 1V$ , $V_{DLV} = 0V$ , 10% to 90%		$\pm 50$	$\pm 130$	
		3V <sub>P-P</sub> programmed, $V_{DHFV} = 3V$ , $V_{DLV} = 0V$ , 10% to 90%		$\pm 50$	$\pm 200$	
		5V <sub>P-P</sub> programmed, $V_{DHFV} = 5V$ , $V_{DLV} = 0V$ , 10% to 90%		$\pm 50$		

# Dual 1.1Gbps Pin Electronics with Integrated PMU and Level-Setting DACs

MAX9979

## ELECTRICAL CHARACTERISTICS (continued)

( $V_{CC} = 9.75V$ ,  $V_{EE} = -4.75V$ ,  $V_{DD} = 3.3V$ ,  $V_{HHP} = 17.5V$ ,  $V_{DHV\_} = 3V$ ,  $V_{DLV\_} = 0V$ ,  $V_{DTV\_} = 1.5V$ ,  $SC1 = SC0 = 0V$ ,  $V_{CPHV\_} = 7.2V$ ,  $V_{CPLV\_} = -2.2V$ ,  $V_{CTV\_} = 1.4V$ ,  $V_{BV\_} = 4V$ ,  $V_{DGS} = V_{GND} = 0V$ ,  $V_{CHV\_} = V_{IVMAX\_} = 2V$ ,  $V_{CLV\_} = V_{IVMIN\_} = 1V$ ,  $V_{COM\_} = 2.5V$ ,  $V_{LDHV\_} = 0V$ ,  $V_{LDLV\_} = 0V$ ,  $V_{IN\_} = 2.5V$ ,  $V_{VIOS} = 0V$ ,  $V_{VIOS} = 2.5V$ ,  $V_{CLAMPHI\_} = 5V$ ,  $V_{CLAMPLO\_} = 0V$ ,  $V_{HH\_} = 10V$ ,  $CDRP = 0b001$ ,  $RO = 0b1000$ ,  $HYST = 0b000$ ,  $Z_{LOAD} = 50\Omega$ ,  $T_J = +70^\circ C$  to an accuracy of  $\pm 15^\circ C$ , unless otherwise noted. All temperature coefficients are measured at  $T_J = +40^\circ C$  to  $+100^\circ C$ , unless otherwise noted.) (Note 1)

PARAMETER	SYMBOL	CONDITIONS		MIN	TYP	MAX	UNITS
Slew Rate		Relative to SC1 = SC0 = 0	SC1 = 0, SC0 = 1, $V_{DHV\_} = 3V$ , $V_{DLV\_} = 0V$ , 20% to 80%		75		%
			SC1 = 1, SC0 = 0, $V_{DHV\_} = 3V$ , $V_{DLV\_} = 0V$ , 20% to 80%		50		
			SC1 = 1, SC0 = 1, $V_{DHV\_} = 3V$ , $V_{DLV\_} = 0V$ , 20% to 80%		25		
Minimum Pulse Width		Positive or negative	0.2V <sub>P-P</sub> programmed, $V_{DHV\_} = 0.2V$ , $V_{DLV\_} = 0V$ (Note 19)		800		ps
			1V <sub>P-P</sub> programmed, $V_{DHV\_} = 1V$ , $V_{DLV\_} = 0V$ (Note 19)		950		
			3V <sub>P-P</sub> programmed, $V_{DHV\_} = 3V$ , $V_{DLV\_} = 0V$ (Notes 4, 19)		1000	1250	
			5V <sub>P-P</sub> programmed, $V_{DHV\_} = 5V$ , $V_{DLV\_} = 0V$ (Note 19)		1300		
Data Rate		To 95% <sub>P-P</sub> (Note 20)	0.2V <sub>P-P</sub> programmed, $V_{DHV\_} = 0.2V$ , $V_{DLV\_} = 0V$		1100		Mbps
			1V <sub>P-P</sub> programmed, $V_{DHV\_} = 1V$ , $V_{DLV\_} = 0V$		900		
			3V <sub>P-P</sub> programmed, $V_{DHV\_} = 3V$ , $V_{DLV\_} = 0V$		800		
			5V <sub>P-P</sub> programmed, $V_{DHV\_} = 5V$ , $V_{DLV\_} = 0V$		680		
		To 90% <sub>P-P</sub> (Note 21)	0.2V <sub>P-P</sub> programmed, $V_{DHV\_} = 0.2V$ , $V_{DLV\_} = 0V$		1200		
			1V <sub>P-P</sub> programmed, $V_{DHV\_} = 1V$ , $V_{DLV\_} = 0V$		1100		
			3V <sub>P-P</sub> programmed, $V_{DHV\_} = 3V$ , $V_{DLV\_} = 0V$		900		
			5V <sub>P-P</sub> programmed, $V_{DHV\_} = 5V$ , $V_{DLV\_} = 0V$		720		

# Dual 1.1Gbps Pin Electronics with Integrated PMU and Level-Setting DACs

## ELECTRICAL CHARACTERISTICS (continued)

( $V_{CC} = 9.75V$ ,  $V_{EE} = -4.75V$ ,  $V_{DD} = 3.3V$ ,  $V_{HHP} = 17.5V$ ,  $V_{DHV\_} = 3V$ ,  $V_{DLV\_} = 0V$ ,  $V_{DTV\_} = 1.5V$ ,  $SC1 = SC0 = 0V$ ,  $V_{CPHV\_} = 7.2V$ ,  $V_{CPLV\_} = -2.2V$ ,  $V_{CTV\_} = 1.4V$ ,  $V_{BV\_} = 4V$ ,  $V_{DGS} = V_{GND} = 0V$ ,  $V_{CHV\_} = V_{IVMAX\_} = 2V$ ,  $V_{CLV\_} = V_{IVMIN\_} = 1V$ ,  $V_{COM\_} = 2.5V$ ,  $V_{LDHV\_} = 0V$ ,  $V_{LDLV\_} = 0V$ ,  $V_{IN\_} = 2.5V$ ,  $V_{VIOS} = 0V$ ,  $V_{VIOS} = 2.5V$ ,  $V_{CLAMPHI\_} = 5V$ ,  $V_{CLAMPLO\_} = 0V$ ,  $V_{HH\_} = 10V$ ,  $CDRP = 0b001$ ,  $RO = 0b1000$ ,  $HYST = 0b000$ ,  $Z_{LOAD} = 50\Omega$ ,  $T_J = +70^\circ C$  to an accuracy of  $\pm 15^\circ C$ , unless otherwise noted. All temperature coefficients are measured at  $T_J = +40^\circ C$  to  $+100^\circ C$ , unless otherwise noted.) (Note 1)

PARAMETER	SYMBOL	CONDITIONS	MIN	TYP	MAX	UNITS
Rise-and-Fall Time		Drive to term, $V_{DHV\_} = 3V$ , $V_{DLV\_} = 0V$ , $V_{DTV\_} = 1.5V$ , measured 10% to 90% of waveform	300	500	1000	ps
		Term to drive, $V_{DHV\_} = 3V$ , $V_{DLV\_} = 0V$ , $V_{DTV\_} = 1.5V$ , measured 10% to 90% of waveform	300	600	850	
<b>HIGH-SPEED COMPARATORS</b>						
<b>DC CHARACTERISTICS</b>						
Input-Voltage Range		(Notes 2, 22)	-1.5		+6.5	V
Differential Input Voltage		$V_{DUT\_} - V_{CHV\_}$ , $V_{DUT\_} - V_{CLV\_}$ (Note 23)			$\pm 8$	V
Input Offset Voltage		$V_{DUT\_} = 1.5V$		$\pm 1$	$\pm 5$	mV
Input-Voltage Temperature Coefficient		(Notes 4, 24)		$\pm 50$	$\pm 175$	$\mu V/^\circ C$
Common-Mode Rejection Ratio	CMRR	$V_{DUT\_} = -1.5V, 6.5V$ (Note 25)	50	55		dB
Linearity Error (Note 26)		0 to 3V, $V_{DUT\_} = 0V, 1.5V, 3V$		$\pm 1$	$\pm 5$	mV
		Full range, $V_{DUT\_} = -1.5V, 0V, 1.5V, 3V, 6.5V$		$\pm 1$	$\pm 10$	
Power-Supply Rejection Ratio	PSRR	$V_{DUT\_} = -1.5$ and $6.5V$ (Notes 5, 27)	50	66		dB
Hysteresis		<b>HYST0</b>				mV
		<b>HYST1</b>				
		<b>HYST2</b>				
		0	0	0	0	
		0	0	1	2	
		0	1	0	4	
		0	1	1	6	
		1	0	0	8	
	1	0	1	10		
	1	1	0	12		
	1	1	1	15		
<b>AC CHARACTERISTICS (Notes 4, 28, 29, 30)</b>						
Minimum Pulse Width		(Note 31)		0.50	0.65	ns
Propagation Delay			0.5	0.9	1.5	ns
Propagation-Delay Temperature Coefficient				1.7		ps/ $^\circ C$
Propagation-Delay Match		High/low vs. low/high, absolute value of delta for each comparator		$\pm 10$	$\pm 25$	ps
Propagation-Delay Dispersion vs. Common-Mode Input		-1.4V to +6.4V (Note 32)		40	55	ps <sub>p-p</sub>
Propagation-Delay Dispersion vs. Duty Cycle		0.6ns to 24.4ns pulse width, relative to 5ns pulse width		$\pm 25$	$\pm 40$	ps
Propagation-Delay Dispersion vs. Slew Rate		1V/ns to 6V/ns, relative to 2V/ns (Note 33)		$\pm 30$	$\pm 55$	ps



# Dual 1.1Gbps Pin Electronics with Integrated PMU and Level-Setting DACs

MAX9979

## ELECTRICAL CHARACTERISTICS (continued)

( $V_{CC} = 9.75V$ ,  $V_{EE} = -4.75V$ ,  $V_{DD} = 3.3V$ ,  $V_{HHP} = 17.5V$ ,  $V_{DHFV} = 3V$ ,  $V_{DLV} = 0V$ ,  $V_{DTV} = 1.5V$ ,  $SC1 = SC0 = 0V$ ,  $V_{CPHV} = 7.2V$ ,  $V_{CPLV} = -2.2V$ ,  $V_{CTV} = 1.4V$ ,  $V_{BV} = 4V$ ,  $V_{DGS} = V_{GND} = 0V$ ,  $V_{CHV} = V_{IVMAX} = 2V$ ,  $V_{CLV} = V_{IVMIN} = 1V$ ,  $V_{COM} = 2.5V$ ,  $V_{LDHFV} = 0V$ ,  $V_{LDLV} = 0V$ ,  $V_{IN} = 2.5V$ ,  $V_{VLOS} = 0V$ ,  $V_{VLOS} = 2.5V$ ,  $V_{CLAMPHI} = 5V$ ,  $V_{CLAMPLO} = 0V$ ,  $V_{HH} = 10V$ ,  $CDRP = 0b001$ ,  $RO = 0b1000$ ,  $HYST = 0b000$ ,  $Z_{LOAD} = 50\Omega$ ,  $T_J = +70^\circ C$  to an accuracy of  $\pm 15^\circ C$ , unless otherwise noted. All temperature coefficients are measured at  $T_J = +40^\circ C$  to  $+100^\circ C$ , unless otherwise noted.) (Note 1)

PARAMETER	SYMBOL	CONDITIONS	MIN	TYP	MAX	UNITS
Equivalent 20–80 Bandwidth		$V_{DTV} = 0.5V$ , driver terminated (Note 34)	1000	1500		MHz
		Driver high impedance		700		
Cable-Droop Compensation, Peaking		1V swing, rise/fall time = 500ps, DRV terminated	CDRP = 0b000		0	%
			CDRP = 0b111		10	
<b>LOGIC OUTPUTS (CH_, NCH_, CL_, NCL_ collector output, <math>R_L = 50\Omega</math> internal pullup to CTV)</b>						
Termination Voltage	CTV_		0		3.5	V
Output High Current				0		mA
Output Low Current				16		mA
Output-Voltage Compliance		Set by $I_{OUT}$ , $R_{TERM}$ and $V_{CTV}$	-0.5		CTV_	V
Differential Rise Time		20% to 80% (Note 4)		200	400	ps
Differential Fall Time		20% to 80% (Note 4)		200	400	ps
Termination Resistor Value		CTV_ to CH_, NCH_, CL_, NCL_	48		52	$\Omega$
Output High Voltage	$V_{OH}$	With output resistors, $R_{TERM}$ to $V_{CTV}$ (Note 56)	CTV_ - 0.1	CTV_ - 0.02	CTV_	V
Output Low Voltage	$V_{OL}$	With output resistors, $R_{TERM}$ to $V_{CTV}$ (Note 56)	CTV_ - 0.55	CTV_ - 0.4	CTV_ - 0.35	V
Output-Voltage Swing		With output resistors, $50\Omega$ nominal trim (Note 56)	350	400	450	mV
<b>DYNAMIC CLAMPS</b>						
CPHV_ Functional Clamp Range		$I_{DUT} = -1mA$ , $V_{CPLV} = -1.5V$ (Note 2)	-0.3		+6.5	V
CPLV_ Functional Clamp Range		$I_{DUT} = 1mA$ , $V_{CPHV} = 6.5V$ (Note 2)	-1.5		+5.3	V
CPHV_ Maximum Programmable Voltage		$I_{DUT} = 0mA$ (Note 23)	7.2	7.5		V
CPLV_ Minimum Programmable Voltage		$I_{DUT} = 0mA$ (Note 23)		-2.5	-2.2	V
Offset Voltage		$I_{DUT} = -1mA$ , $V_{CPHV} = 1.5V$ , $V_{CPLV} = -1.5V$			$\pm 10$	mV
		$I_{DUT} = 1mA$ , $V_{CPLV} = 1.5V$ , $V_{CPHV} = 6.5V$			$\pm 10$	
Offset-Voltage Temperature Coefficient		$V_{CPHV} = V_{CPLV} = 1.5V$		0.5		mV/ $^\circ C$
Power-Supply Rejection Ratio		$I_{DUT} = -1mA$ , $V_{CPHV} = 1.5V$ , $V_{CPLV} = -1.5V$ (Note 5)	40			dB
		$I_{DUT} = +1mA$ , $V_{CPLV} = 1.5V$ , $V_{CPHV} = 6.5V$ (Note 5)	40			
High Clamp Voltage Gain		$V_{CPHV} = -0.3V$ , 6.5V	0.998		1.002	V/V
Low Clamp Voltage Gain		$V_{CPLV} = -1.5V$ , 5.3V	0.998		1.002	V/V
Voltage-Gain Temperature Coefficient				100		ppm/ $^\circ C$

# Dual 1.1Gbps Pin Electronics with Integrated PMU and Level-Setting DACs

## ELECTRICAL CHARACTERISTICS (continued)

( $V_{CC} = 9.75V$ ,  $V_{EE} = -4.75V$ ,  $V_{DD} = 3.3V$ ,  $V_{HHP} = 17.5V$ ,  $V_{DHV\_} = 3V$ ,  $V_{DLV\_} = 0V$ ,  $V_{DTV\_} = 1.5V$ ,  $SC1 = SC0 = 0V$ ,  $V_{CPHV\_} = 7.2V$ ,  $V_{CPLV\_} = -2.2V$ ,  $V_{CTV\_} = 1.4V$ ,  $V_{BV\_} = 4V$ ,  $V_{DGS} = V_{GND} = 0V$ ,  $V_{CHV\_} = V_{IVMAX\_} = 2V$ ,  $V_{CLV\_} = V_{IVMIN\_} = 1V$ ,  $V_{COM\_} = 2.5V$ ,  $V_{LDHV\_} = 0V$ ,  $V_{LDLV\_} = 0V$ ,  $V_{IN\_} = 2.5V$ ,  $V_{VIOS} = 0V$ ,  $V_{VIOS} = 2.5V$ ,  $V_{CLAMPHI\_} = 5V$ ,  $V_{CLAMPLO\_} = 0V$ ,  $V_{HH\_} = 10V$ ,  $CDRP = 0b001$ ,  $RO = 0b1000$ ,  $HYST = 0b000$ ,  $Z_{LOAD} = 50\Omega$ ,  $T_J = +70^\circ C$  to an accuracy of  $\pm 15^\circ C$ , unless otherwise noted. All temperature coefficients are measured at  $T_J = +40^\circ C$  to  $+100^\circ C$ , unless otherwise noted.) (Note 1)

PARAMETER	SYMBOL	CONDITIONS	MIN	TYP	MAX	UNITS
Linearity		$I_{DUT\_} = -1mA$ , $V_{CPHV\_} = -0.3V, 1.5V, 3.25V, 5V, 6.5V$			$\pm 30$	mV
		$I_{DUT\_} = 1mA$ , $V_{CPLV\_} = -1.5V, 0.5V, 2.25V, 4V, 5.3V$			$\pm 30$	
Static Output Current		$V_{CPHV\_} = 0V$ , $V_{CPLV\_} = -1.5V$ , $R_L = 0\Omega$ to $6.5V$	-120		-60	mA
		$V_{CPLV\_} = 5V$ , $V_{CPHV\_} = 6.5V$ , $R_L = 0\Omega$ to $-1.5V$	60		120	
High Clamp Resistance		$V_{CPHV\_} = 0V$ , $V_{CPLV\_} = -1.5V$ , $I_{DUT\_} = -5mA$ and $-15mA$	48		55	$\Omega$
Low Clamp Resistance		$V_{CPHV\_} = 6.5V$ , $V_{CPLV\_} = 0V$ , $I_{DUT\_} = 5mA$ and $15mA$	48		55	$\Omega$
High Clamp-Resistance Variation		$I_{DUT\_} = -20mA$ and $-30mA$ , $V_{CPHV\_} = 2.5V$ , $V_{CPLV\_} = -1.5V$ (Note 35)		$\pm 5$		$\Omega$
Low Clamp-Resistance Variation		$I_{DUT\_} = 20mA$ and $30mA$ , $V_{CPLV\_} = 2.5V$ , $V_{CPHV\_} = 6.5V$ (Note 35)		$\pm 5$		$\Omega$
Overshoot and Undershoot		(Note 36)		700		mV
<b>PARAMETRIC MEASUREMENT UNIT (PMU)</b>						
<b>DC ELECTRICAL CHARACTERISTICS</b>						
<b>FORCE VOLTAGE (<math>R_L \geq 10M\Omega</math>, <math>V_{IN\_} = 2.5V</math>, unless otherwise noted)</b>						
Force-Voltage Output Range (Note 2)	$V_{IN}$	$I_{DUT\_} = 0mA$	-1.5		+6.5	V
		$I_{DUT\_} = +FSR/2$ , range A	-1.5		+4.5	
		$I_{DUT\_} = +FSR/2$ , ranges B-E	-1.5		+6.1	
		$I_{DUT\_} = -FSR/2$ , range A	1.1		6.5	
		$I_{DUT\_} = -FSR/2$ , ranges B-E	-1.1		+6.5	
Force-Voltage Offset Error		$I_{DUT\_} = 0mA$	-5		+5	mV
Force-Voltage PSRR		(Note 5)	-5		+5	mV/V
Force-Voltage Load Regulation		$I_{DUT\_} = +FSR/2$ to $-FSR/2$ using $SENSE\_$ input		$\pm 200$		$\mu V$
Force-Voltage Offset Temperature Coefficient		(Note 37)		$\pm 50$		$\mu V/^\circ C$
Force-Voltage Gain Error		$V_{IN} = -1.5V$ to $+6.5V$ , nominal gain = +1	-0.1		+0.1	%
Force-Voltage Gain Temperature Coefficient				$\pm 10$		ppm/ $^\circ C$
Force-Voltage Linearity Error		$V_{IN} = -1.5V, 0.5V, 2.5V, 4.5V, 6.5V$ (Notes 38, 39)	-0.02		+0.02	%FSR

# Dual 1.1Gbps Pin Electronics with Integrated PMU and Level-Setting DACs

MAX9979

## ELECTRICAL CHARACTERISTICS (continued)

(V<sub>CC</sub> = 9.75V, V<sub>EE</sub> = -4.75V, V<sub>DD</sub> = 3.3V, V<sub>HHP</sub> = 17.5V, V<sub>DHV<sub>-</sub></sub> = 3V, V<sub>DLV<sub>-</sub></sub> = 0V, V<sub>DTV<sub>-</sub></sub> = 1.5V, SC1 = SC0 = 0V, V<sub>CPHV<sub>-</sub></sub> = 7.2V, V<sub>CPLV<sub>-</sub></sub> = -2.2V, V<sub>CTV<sub>-</sub></sub> = 1.4V, V<sub>BV<sub>-</sub></sub> = 4V, V<sub>DGS</sub> = V<sub>GND</sub> = 0V, V<sub>CHV<sub>-</sub></sub> = V<sub>IIVMAX<sub>-</sub></sub> = 2V, V<sub>CLV<sub>-</sub></sub> = V<sub>IIVMIN<sub>-</sub></sub> = 1V, V<sub>COM<sub>-</sub></sub> = 2.5V, V<sub>LDHV<sub>-</sub></sub> = 0V, V<sub>LDLV<sub>-</sub></sub> = 0V, V<sub>IN<sub>-</sub></sub> = 2.5V, V<sub>VIOS</sub> = 0V, V<sub>IIOS</sub> = 2.5V, V<sub>CLAMPHI<sub>-</sub></sub> = 5V, V<sub>CLAMPLO<sub>-</sub></sub> = 0V, V<sub>HH<sub>-</sub></sub> = 10V, CDRP = 0b001, RO = 0b1000, HYST = 0b000, Z<sub>LOAD</sub> = 50Ω, T<sub>J</sub> = +70°C to an accuracy of ±15°C, unless otherwise noted. All temperature coefficients are measured at T<sub>J</sub> = +40°C to +100°C, unless otherwise noted.) (Note 1)

PARAMETER	SYMBOL	CONDITIONS	MIN	TYP	MAX	UNITS
Force-Voltage Range Switching Glitch		From any two adjacent ranges, C <sub>DUT<sub>-</sub></sub> = 100pF, I <sub>DUT<sub>-</sub></sub> = (±0.25 × FSR) of lower current range (Note 4)			0.3	V
<b>MEASURE CURRENT (Measured at MEAS<sub>-</sub> in FIMI mode, V<sub>IN<sub>-</sub></sub> = V<sub>IIOS</sub> = V<sub>DUT<sub>-</sub></sub> = 2.5V)</b>						
Measure-Current Offset	I <sub>MOS</sub>	(Note 38)	-1		+1	%FSR
Measure-Current PSRR		I <sub>DUT<sub>-</sub></sub> = 0mA (Note 5)	-0.05		+0.05	%FSR/V
Measure-Current Offset Temperature Coefficient				±20		ppmFSR/°C
Measure-Current Gain Error	I <sub>MGE</sub>	Ranges A, B, C	-1.0		+1.0	%
		Ranges D, E	-1.1		+1.1	
Measure-Current Gain Temperature Coefficient		Ranges B–E		±20		ppm/°C
		Range A		+100		
Measure-Current Linearity Error (Note 38)	I <sub>MLER</sub>	Ranges B–E, I <sub>DUT<sub>-</sub></sub> = -FSR/2, -FSR/4, 0, FSR/4, FSR/2 relative to end points	-0.02		+0.02	%FSR
		Range A, I <sub>DUT<sub>-</sub></sub> = -30mA, -15mA, 0, 15mA, 30mA, relative to end points	-0.03		+0.03	
		Range A, I <sub>DUT<sub>-</sub></sub> = -FSR/2, -FSR/4, 0, FSR/4, FSR/2 relative to end points	-0.06		+0.06	
+FSR Measure Output Voltage		V <sub>IIOSMIN</sub> = 2V (Note 40)		6		V
		V <sub>IIOSMAX</sub> = 4V (Note 40)		8		
-FSR Measure Output Voltage		V <sub>IIOSMIN</sub> = 2V (Note 40)		-2		V
		V <sub>IIOSMAX</sub> = 4V (Note 40)		0		
Rejection of Output Measure Error Due to Common-Mode Sense Voltage	CMV <sub>R<sub>LER</sub></sub>	I <sub>DUT<sub>-</sub></sub> = 0mA, V <sub>IN<sub>-</sub></sub> = -1.5V to +6.5V, percent FSR change at MEAS <sub>-</sub> per volt change at DUT <sub>-</sub>			0.003	%FSR/V
Measure-Current Range (Note 2)		Range E, R <sub>E</sub> = 500kΩ	-2		+2	μA
		Range D, R <sub>D</sub> = 50kΩ	-20		+20	
		Range C, R <sub>C</sub> = 5kΩ	-200		+200	
		Range B, R <sub>B</sub> = 500Ω	-2		+2	mA
		Range A, R <sub>A</sub> = 20Ω (Note 41)	-50		+50	
<b>FORCE CURRENT (V<sub>DUT<sub>-</sub></sub> = V<sub>IN<sub>-</sub></sub> = V<sub>IIOS</sub> = 2.5V, unless otherwise noted)</b>						
Input-Voltage Range For Setting Force Current to +FSR/2		V <sub>IIOSMIN</sub> = 2V		6		V
		V <sub>IIOSMAX</sub> = 3.5V		7.5		
Input-Voltage Range For Setting Force Current to -FSR/2		V <sub>IIOSMIN</sub> = 2V		-2		V
		V <sub>IIOSMAX</sub> = 3.5V		-0.5		
Current-Sense Amplifier Offset Voltage Input		Relative to V <sub>DGS</sub>	2.0	2.5	3.5	V

# Dual 1.1Gbps Pin Electronics with Integrated PMU and Level-Setting DACs

## ELECTRICAL CHARACTERISTICS (continued)

( $V_{CC} = 9.75V$ ,  $V_{EE} = -4.75V$ ,  $V_{DD} = 3.3V$ ,  $V_{HHP} = 17.5V$ ,  $V_{DHV\_} = 3V$ ,  $V_{DLV\_} = 0V$ ,  $V_{DTV\_} = 1.5V$ ,  $SC1 = SC0 = 0V$ ,  $V_{CPHV\_} = 7.2V$ ,  $V_{CPLV\_} = -2.2V$ ,  $V_{CTV\_} = 1.4V$ ,  $V_{BV\_} = 4V$ ,  $V_{DGS} = V_{GND} = 0V$ ,  $V_{CHV\_} = V_{IVMAX\_} = 2V$ ,  $V_{CLV\_} = V_{IVMIN\_} = 1V$ ,  $V_{COM\_} = 2.5V$ ,  $V_{LDHV\_} = 0V$ ,  $V_{LDLV\_} = 0V$ ,  $V_{IN\_} = 2.5V$ ,  $V_{VIOS} = 0V$ ,  $V_{ILOS} = 2.5V$ ,  $V_{CLAMPHI\_} = 5V$ ,  $V_{CLAMPLO\_} = 0V$ ,  $V_{HH\_} = 10V$ ,  $CDRP = 0b001$ ,  $RO = 0b1000$ ,  $HYST = 0b000$ ,  $Z_{LOAD} = 50\Omega$ ,  $T_J = +70^\circ C$  to an accuracy of  $\pm 15^\circ C$ , unless otherwise noted. All temperature coefficients are measured at  $T_J = +40^\circ C$  to  $+100^\circ C$ , unless otherwise noted.) (Note 1)

PARAMETER	SYMBOL	CONDITIONS	MIN	TYP	MAX	UNITS
Force-Current Offset		(Note 38)	-0.1		+0.1	%FSR
Force-Current Offset PSRR		(Note 5)	-0.2		+0.2	%FSR/V
Force-Current Offset-Temperature Coefficient		(Note 37)		$\pm 20$		ppmFSR/ $^\circ C$
Force-Current Gain Error		$V_{IN\_} = -1.5V$ and $6.5V$	-0.1		+0.1	%
Force-Current Gain-Temperature Coefficient		Ranges B–E		$\pm 20$		ppm/ $^\circ C$
		Range A		-100		
Force-Current Linearity Error (Notes 38, 39)		Ranges B–E, $V_{IN\_} = -1.5V, 0.5V, 2.5V, 4.5V, 6.5V$ relative to end points of $I_{DUT\_}$	-0.025		+0.025	%FSR
		Range A, $I_{DUT\_} \pm 30mA$ , $V_{IN\_} = 0V, 1V, 1.3V, 2.5V, 3.7V, 4.9V$ relative to end points of $I_{DUT\_}$	-0.03		+0.03	
		Range A, $V_{IN\_} = -1.5V, 0.5V, 2.5V, 4.5V, 6.5V$ relative to end points of $I_{DUT\_}$	-0.06		+0.06	
Rejection of Output Error Due to Common-Mode $DUT\_$ Voltage		Percent of FSR change of the force current per volt change in $DUT\_$ , $V_{DUT\_} = -1.5V$ to $6.5V$			0.007	%FSR/V
Force-Current Range (Note 2)		Range E, $R_{E} = 500k\Omega$	-2		+2	$\mu A$
		Range D, $R_{D} = 50k\Omega$	-20		+20	
		Range C, $R_{C} = 5k\Omega$	-200		+200	
		Range B, $R_{B} = 500\Omega$	-2		+2	mA
		Range A, $R_{A} = 20$ , (Note 41)	-50		+50	
<b>MEASURE VOLTAGE (Measured at MEAS_ in FVMV mode, <math>V_{VIOS} = 0</math>, <math>V_{DUT\_} = V_{IN\_} = V_{ILOS} = 2.5V</math>)</b>						
Measure-Voltage Offset			-25		+25	mV
Measure-Voltage PSRR		(Note 5)	-5		+5	mV/V
Measure-Voltage Offset Temperature Coefficient				$\pm 100$		$\mu V/^\circ C$
Measure-Voltage Gain Error		$V_{DUT\_} = -1.5V$ and $6.5V$ , nominal gain = +1	-1		+1	%
Measure-Voltage Gain-Temperature Coefficient				$\pm 10$		ppm/ $^\circ C$
Measure-Voltage Linearity Error		$V_{IN\_} = -1.5V, 0.5V, 2.5V, 4.5V, 6.5V$ relative to end points. (Note 38)	-0.02		+0.02	%FSR
Measure Output Voltage (Note 42)		For $V_{DUT\_} = 6.5V$ , measure voltage input range = $-1.5V$ to $6.5V$ , $V_{VIOS}$ offsets the range at MEAS_		$6.5 + V_{VIOS}$		V
		For $V_{DUT\_} = -1.5V$		$-1.5 + V_{VIOS}$		
Voltage Sense Amp Offset Voltage Input	$V_{IOS}$	Relative to DUT ground (Note 42)	0		1.5	V

# Dual 1.1Gbps Pin Electronics with Integrated PMU and Level-Setting DACs

MAX9979

## ELECTRICAL CHARACTERISTICS (continued)

( $V_{CC} = 9.75V$ ,  $V_{EE} = -4.75V$ ,  $V_{DD} = 3.3V$ ,  $V_{HHP} = 17.5V$ ,  $V_{DHV\_} = 3V$ ,  $V_{DLV\_} = 0V$ ,  $V_{DTV\_} = 1.5V$ ,  $SC1 = SC0 = 0V$ ,  $V_{CPHV\_} = 7.2V$ ,  $V_{CPLV\_} = -2.2V$ ,  $V_{CTV\_} = 1.4V$ ,  $V_{BV\_} = 4V$ ,  $V_{DGS} = V_{GND} = 0V$ ,  $V_{CHV\_} = V_{IVMAX\_} = 2V$ ,  $V_{CLV\_} = V_{IVMIN\_} = 1V$ ,  $V_{COM\_} = 2.5V$ ,  $V_{LDHV\_} = 0V$ ,  $V_{LDLV\_} = 0V$ ,  $V_{IN\_} = 2.5V$ ,  $V_{VIOS} = 0V$ ,  $V_{IIO} = 2.5V$ ,  $V_{CLAMPHI\_} = 5V$ ,  $V_{CLAMPLO\_} = 0V$ ,  $V_{HH\_} = 10V$ ,  $CDRP = 0b001$ ,  $RO = 0b1000$ ,  $HYST = 0b000$ ,  $Z_{LOAD} = 50\Omega$ ,  $T_J = +70^\circ C$  to an accuracy of  $\pm 15^\circ C$ , unless otherwise noted. All temperature coefficients are measured at  $T_J = +40^\circ C$  to  $+100^\circ C$ , unless otherwise noted.) (Note 1)

PARAMETER	SYMBOL	CONDITIONS	MIN	TYP	MAX	UNITS
<b>FORCE OUTPUT</b>						
Short-Circuit Current Limit in FV Mode		Range A, $V_{IN\_} = -1.5V$ , $V_{DUT\_} = 6.5V$ , $CLENABLE = 0$	-100		-55	mA
		Range B, $V_{IN\_} = -1.5V$ , $V_{DUT\_} = 6.5V$ , $CLENABLE = 0$	-8		-3	
		Range A, $V_{IN\_} = 6.5V$ , $V_{DUT\_} = -1.5V$ , $CLENABLE = 0$	55		100	
		Range B, $V_{IN\_} = 6.5V$ , $V_{DUT\_} = -1.5V$ , $CLENABLE = 0$	3		8	
Force-to-Sense Resistor	$R_{FS}$	(Note 4)		10		k
<b>SENSE INPUT</b>						
Input-Voltage Range		All modes except $V_{HHP}$ driver mode	-1.5		+6.5	V
		$V_{HH\_}$ driver-mode compliance, SENSE open (Note 43)	-1.5		+13.0	
Input Bias Current		$V_{SENSE\_} = -1.5V$ and $6.5V$ , sense input enabled	-5		+5	nA
<b>COMPARATOR INPUTS (<math>V_{IN\_} = V_{IIO} = 2.5V</math>, <math>HYSTEN = 0</math>, unless otherwise noted)</b>						
Input-Voltage Range		Maximum at $V_{IIO} = 3.4V$ , MI mode		+7.4		V
		Minimum at $V_{IIO} = 2V$ , MI mode		-2.2		
FIMV Offset Voltage		$V_{DUT\_} = 2.5V$ (Note 44)	-5		+5	mV
FVMI Offset Current		$IV_{MAX\_} = IV_{MIN\_} = 2.5V$ (Note 44)	-0.1		+0.1	%FSR
Hysteresis		$HYSTEN = 1$ , functionally tested in MV mode		$\pm 25$	$\pm 50$	mV
<b>VOLTAGE CLAMPS (FI mode, <math>CLENABLE\_ = 1</math>)</b>						
Clamp Voltage Range		(Note 45)	-1.5		+6.5	V
Linear FI DUT_ Range		FI loop not influenced when $V_{DUT\_} 0.5V$ from voltage clamps	$V_{CLAMPLO\_} + 0.5$		$V_{CLAMPHI\_} - 0.5$	V
Clamp Voltage Accuracy		$V_{CLAMPHI\_} = V_{CLAMPLO\_} = -1.5V, 0V, 1.5V, 2.5V, 4V, 5V, 6.5V$	-20		+20	mV
<b>CURRENT CLAMPS (FV mode, <math>CLENABLE\_ = 1</math>)</b>						
Input Control Voltage Range	$V_{CLAMPHI\_MAX}$	Clamp current = $I_{CLAMPHI\_} = (V_{CLAMPHI\_} - V_{IIO})/R_{RANGE}$ (sourcing)		$V_{IIO} + 1.3V$		V
	$V_{CLAMPLO\_MIN}$	Clamp current = $I_{CLAMPLO\_} = (V_{CLAMPLO\_} - V_{IIO})/R_{RANGE}$ (sinking)		$V_{IIO} - 1.3V$		

# Dual 1.1Gbps Pin Electronics with Integrated PMU and Level-Setting DACs

## ELECTRICAL CHARACTERISTICS (continued)

( $V_{CC} = 9.75V$ ,  $V_{EE} = -4.75V$ ,  $V_{DD} = 3.3V$ ,  $V_{HHP} = 17.5V$ ,  $V_{DHV\_} = 3V$ ,  $V_{DLV\_} = 0V$ ,  $V_{DTV\_} = 1.5V$ ,  $SC1 = SC0 = 0V$ ,  $V_{CPHV\_} = 7.2V$ ,  $V_{CPLV\_} = -2.2V$ ,  $V_{CTV\_} = 1.4V$ ,  $V_{BV\_} = 4V$ ,  $V_{DGS} = V_{GND} = 0V$ ,  $V_{CHV\_} = V_{IVMAX\_} = 2V$ ,  $V_{CLV\_} = V_{IVMIN\_} = 1V$ ,  $V_{COM\_} = 2.5V$ ,  $V_{LDHV\_} = 0V$ ,  $V_{LDLV\_} = 0V$ ,  $V_{IN\_} = 2.5V$ ,  $V_{VIOS} = 0V$ ,  $V_{VIOS} = 2.5V$ ,  $V_{CLAMPHI\_} = 5V$ ,  $V_{CLAMPLO\_} = 0V$ ,  $V_{HH\_} = 10V$ ,  $CDRP = 0b001$ ,  $RO = 0b1000$ ,  $HYST = 0b000$ ,  $Z_{LOAD} = 50\Omega$ ,  $T_J = +70^\circ C$  to an accuracy of  $\pm 15^\circ C$ , unless otherwise noted. All temperature coefficients are measured at  $T_J = +40^\circ C$  to  $+100^\circ C$ , unless otherwise noted.) (Note 1)

PARAMETER	SYMBOL	CONDITIONS	MIN	TYP	MAX	UNITS
Clamp Current Range (Note 45)		Range E, $R_E = 500k\Omega$	-2.2		+2.2	$\mu A$
		Range D, $R_D = 50k\Omega$	-22		+22	
		Range C, $R_C = 5k\Omega$	-220		+220	
		Range B, $R_B = 500\Omega$	-2.2		+2.2	mA
		Range A, $R_A = 20\Omega$	-55		+55	
Linear FV $I_{DUT\_}$ Range		FV loop not influenced when $I_{DUT\_} \geq 10\%$ FSR from current clamps	$I_{CLAMPLO\_} + 10\%FSR$		$I_{CLAMPHI\_} - 10\%FSR$	A
Clamp Current Accuracy		$ I_{CLAMPHI\_}  =  I_{CLAMPLO\_}  = 0$ , (0.25 x FSR), (0.50 x FSR) and (0.55 x FSR), calibrated at 0 and (0.50 x FSR)	-0.5		+0.5	%FSR
<b>COMPARATOR OUTPUTS (Note 46)</b>						
Output High Voltage		$R_{PULLUP} = 1k\Omega$ to $V_{DD}$	$V_{DD} - 0.2$			V
Output Low Voltage		$R_{PULLUP} = 1k\Omega$ to $V_{DD}$			0.4	V
High-Impedance State Leakage Current				$\pm 1$		$\mu A$
High-Impedance State Output Capacitance				6		pF
<b>AC ELECTRICAL CHARACTERISTICS (<math>V_{VIOS} = 0V</math>, <math>V_{VIOS} = 2.5V</math>, <math>C_{DUT\_} = C_{MEAS\_} = 100pF</math>, <math>R_{DUT\_} = 4 \times R_{RANGE}</math> to 2.5V, unless otherwise noted; setting times are to 0.1%FSR)</b>						
<b>FORCE VOLTAGE</b>						
Settling Time		$V_{IN\_} = -1.5V, 6.5V$	Range E, $R_E = 500k\Omega$	140		$\mu s$
			Range D, $R_D = 50k\Omega$	30		
			Range C, $R_C = 5k\Omega$	20	30	
			Range B, $R_B = 500\Omega$	20		
		$V_{IN\_} = -1V$ to $+6.5V$	Range A, $R_A = 20\Omega$ , $R_{DUT\_} = 200\Omega$ to 2.5V (Note 41)	20		
Maximum Stable Load Capacitance				2500		pF
<b>FORCE VOLTAGE/MEASURE CURRENT</b>						
Settling Time		Range E, $R_E = 500k\Omega$		300		$\mu s$
		Range D, $R_D = 50k\Omega$		40		
		Range C, $R_C = 5k\Omega$		20	35	
		Range B, $R_B = 500\Omega$		20		
		Range A, $R_A = 20\Omega$ , $R_{DUT\_} = 200\Omega$ to 2.5V (Note 41)		20		

# Dual 1.1Gbps Pin Electronics with Integrated PMU and Level-Setting DACs

MAX9979

## ELECTRICAL CHARACTERISTICS (continued)

( $V_{CC} = 9.75V$ ,  $V_{EE} = -4.75V$ ,  $V_{DD} = 3.3V$ ,  $V_{HHP} = 17.5V$ ,  $V_{DHV} = 3V$ ,  $V_{DLV} = 0V$ ,  $V_{DTV} = 1.5V$ ,  $SC1 = SC0 = 0V$ ,  $V_{CPHV} = 7.2V$ ,  $V_{CPLV} = -2.2V$ ,  $V_{CTV} = 1.4V$ ,  $V_{BV} = 4V$ ,  $V_{DGS} = V_{GND} = 0V$ ,  $V_{CHV} = V_{IVMAX} = 2V$ ,  $V_{CLV} = V_{IVMIN} = 1V$ ,  $V_{COM} = 2.5V$ ,  $V_{LDHV} = 0V$ ,  $V_{LDLV} = 0V$ ,  $V_{IN} = 2.5V$ ,  $V_{VIOS} = 0V$ ,  $V_{IIOS} = 2.5V$ ,  $V_{CLAMPHI} = 5V$ ,  $V_{CLAMPLO} = 0V$ ,  $V_{HH} = 10V$ ,  $CDRP = 0b001$ ,  $RO = 0b1000$ ,  $HYST = 0b000$ ,  $Z_{LOAD} = 50\Omega$ ,  $T_J = +70^\circ C$  to an accuracy of  $\pm 15^\circ C$ , unless otherwise noted. All temperature coefficients are measured at  $T_J = +40^\circ C$  to  $+100^\circ C$ , unless otherwise noted.) (Note 1)

PARAMETER	SYMBOL	CONDITIONS	MIN	TYP	MAX	UNITS
Range-Change Switching		In addition to force-voltage and measure-current settling times, range A to range B (Note 47)		20		$\mu s$
<b>FORCE CURRENT (Measured at MEAS_ in FIMI Mode)</b>						
Settling Time	$V_{IN} = -1.5V$ , $+6.5V$	Range E, $R_E = 500k\Omega$		500		$\mu s$
		Range D, $R_D = 50k\Omega$		100		
		Range C, $R_C = 5k\Omega$		25	35	
		Range B, $R_B = 500\Omega$		20		
	$V_{IN} = -1.1V$ to $+4.1V$	Range A, $R_A = 20\Omega$ $R_{DUT} = 200\Omega$ to $2.5V$ (Note 41)		20		
<b>FORCE CURRENT/MEASURE VOLTAGE (Note 48)</b>						
Settling Time		Range E, $R_E = 500k\Omega$		1900		$\mu s$
		Range D, $R_D = 50k\Omega$		200		
		Range C, $R_C = 5k\Omega$		30	40	
		Range B, $R_B = 500\Omega$		20		
		Range A, $R_A = 20\Omega$ , $R_{DUT} = 200\Omega$ to $2.5V$ (Note 41)		20		
Range-Change Switching		In addition to force-current/measure-voltage settling times, range A to range B. (Note 47)		20		$\mu s$
<b>SENSE INPUT TO MEASURE OUTPUT PATH (Note 49)</b>						
Propagation Delay		Measured at 90% of output, SENSE input slew rate $\leq 2V/\mu s$		0.07		$\mu s$
<b>MEASURE OUTPUT</b>						
High-Impedance Leakage Current		$V_{MEAS} = -1.5V, 2.5V, 6.5V$	-10		+10	nA
HIZMEASP_ True to High-Impedance Time		$R_{MEAS} = 5k\Omega$ to GND, $V_{SENSE} = 2.5V$ , measured from the 50% point of $\overline{HIZMEASP}_$ to 90% of output		80		ns
$\overline{HIZMEASP}_$ False to Active Time		$R_{MEAS} = 5k\Omega$ to GND, $V_{SENSE} = 2.5V$ , measured from the 50% point of $\overline{HIZMEASP}_$ to 10% of output		40		ns
Maximum Stable Load Capacitance				1000		pF
<b>FORCE OUTPUT</b>						
$\overline{LLEAKP}_$ True to Low-Leak Time		$V_{IN} = 1V$ , $R_{DUT} = R_{RANGE}$ to GND, FVMI mode, measured from the 50% point of $\overline{LLEAKP}_$ to 90% of output		0.3		$\mu s$

# Dual 1.1Gbps Pin Electronics with Integrated PMU and Level-Setting DACs

## ELECTRICAL CHARACTERISTICS (continued)

( $V_{CC} = 9.75V$ ,  $V_{EE} = -4.75V$ ,  $V_{DD} = 3.3V$ ,  $V_{HHP} = 17.5V$ ,  $V_{DHV} = 3V$ ,  $V_{DLV} = 0V$ ,  $V_{DTV} = 1.5V$ ,  $SC1 = SC0 = 0V$ ,  $V_{CPHV} = 7.2V$ ,  $V_{CPLV} = -2.2V$ ,  $V_{CTV} = 1.4V$ ,  $V_{BV} = 4V$ ,  $V_{DGS} = V_{GND} = 0V$ ,  $V_{CHV} = V_{IVMAX} = 2V$ ,  $V_{CLV} = V_{IVMIN} = 1V$ ,  $V_{COM} = 2.5V$ ,  $V_{LDHV} = 0V$ ,  $V_{LDLV} = 0V$ ,  $V_{IN} = 2.5V$ ,  $V_{VIOS} = 0V$ ,  $V_{VIOS} = 2.5V$ ,  $V_{CLAMPHI} = 5V$ ,  $V_{CLAMPLO} = 0V$ ,  $V_{HH} = 10V$ ,  $CDRP = 0b001$ ,  $RO = 0b1000$ ,  $HYST = 0b000$ ,  $Z_{LOAD} = 50\Omega$ ,  $T_J = +70^\circ C$  to an accuracy of  $\pm 15^\circ C$ , unless otherwise noted. All temperature coefficients are measured at  $T_J = +40^\circ C$  to  $+100^\circ C$ , unless otherwise noted.) (Note 1)

PARAMETER	SYMBOL	CONDITIONS	MIN	TYP	MAX	UNITS
$\overline{LLEAKP}_-$ False to Active Time		$V_{IN} = 1V$ , $R_{DUT} = R_{RANGE}$ to GND, FVMI mode, measured from the 50% point of $\overline{LLEAKP}_-$ to 10% of output		0.3		$\mu s$
<b>COMPARATORS (<math>C_{CMP} = 20PF</math>, <math>R_{PULLUP} = 1k\Omega</math> to <math>V_{DD}</math>)</b>						
Rise Time		20% to 80%		35		ns
Fall Time		80% to 20%		1.5		ns
Disable True to High Impedance		Measured from the 50% point of $\overline{CS}$ (or $\overline{LOAD}$ ) to 10% of the output		25		ns
Disable False to Active		Measured from the 50% point of $\overline{CS}$ (or $\overline{LOAD}$ ) to 90% of the output		20		ns
<b>ACTIVE LOAD</b>						
<b>DC CHARACTERISTICS (<math>V_{COM} = 2.5V</math>, <math>V_{DHV} = V_{DLV} = 6V</math>, unless otherwise noted)</b>						
$V_{COM}$ Voltage Range	$V_{COM}$		-1.5		+6.5	V
$V_{COM}$ Offset Voltage		$I_{DUT} = 0mA$			$\pm 5$	mV
Differential Voltage Range		$V_{DUT} - V_{COM}$	-8		+8	V
Offset Voltage-Temperature Coefficient				100		$\mu V/^\circ C$
$V_{COM}$ Voltage Gain		$V_{COM} = 0, 4.5V$	0.998	1	1.002	V/V
$V_{COM}$ Voltage-Gain Temperature Coefficient				-10		ppm/ $^\circ C$
$V_{COM}$ Linearity Error		$V_{COM} = -1.5V, 0V, 1.5V, 3V, 4.5V, 6.5V$ relative to end points		$\pm 3$	$\pm 15$	mV
$V_{COM}$ Output-Voltage Power-Supply Rejection Ratio		(Note 5)	40			dB
Sink or Source Output Resistance		$V_{DUT} = 3V, 6.5V$ with $V_{COM} = -1.5V$ or $V_{DUT} = -1.5V, 2V$ with $V_{COM} = 6.5V$	$I_{SOURCE} = I_{SINK} = 20mA$	30		k $\Omega$
			$I_{SOURCE} = I_{SINK} = 1mA$	250		
Linear Region Output Resistance		$I_{DUT} = \pm 10mA$		12	18	$\Omega$
Dead-Band		$I_{SOURCE} = I_{SINK} = 10mA$ , 80% commutation		400		mV
			95% $I_{SOURCE}$ to 95% $I_{SINK}$ , $I_{SOURCE} = I_{SINK} = 20mA$	700	900	



# Dual 1.1Gbps Pin Electronics with Integrated PMU and Level-Setting DACs

MAX9979

## ELECTRICAL CHARACTERISTICS (continued)

( $V_{CC} = 9.75V$ ,  $V_{EE} = -4.75V$ ,  $V_{DD} = 3.3V$ ,  $V_{HHP} = 17.5V$ ,  $V_{DHV\_} = 3V$ ,  $V_{DLV\_} = 0V$ ,  $V_{DTV\_} = 1.5V$ ,  $SC1 = SC0 = 0V$ ,  $V_{CPHV\_} = 7.2V$ ,  $V_{CPLV\_} = -2.2V$ ,  $V_{CTV\_} = 1.4V$ ,  $V_{BV\_} = 4V$ ,  $V_{DGS} = V_{GND} = 0V$ ,  $V_{CHV\_} = V_{IVMAX\_} = 2V$ ,  $V_{CLV\_} = V_{IVMIN\_} = 1V$ ,  $V_{COM\_} = 2.5V$ ,  $V_{LDHV\_} = 0V$ ,  $V_{LDLV\_} = 0V$ ,  $V_{IN\_} = 2.5V$ ,  $V_{VIOS} = 0V$ ,  $V_{IIOS} = 2.5V$ ,  $V_{CLAMPHI\_} = 5V$ ,  $V_{CLAMPLO\_} = 0V$ ,  $V_{HH\_} = 10V$ ,  $CDRP = 0b001$ ,  $RO = 0b1000$ ,  $HYST = 0b000$ ,  $Z_{LOAD} = 50\Omega$ ,  $T_J = +70^\circ C$  to an accuracy of  $\pm 15^\circ C$ , unless otherwise noted. All temperature coefficients are measured at  $T_J = +40^\circ C$  to  $+100^\circ C$ , unless otherwise noted.) (Note 1)

PARAMETER	SYMBOL	CONDITIONS	MIN	TYP	MAX	UNITS
<b>SOURCE CURRENT (<math>V_{DUT\_} = -1V</math>, <math>V_{VCOM\_} = 6V</math>, <math>V_{VLDL\_} = 0V</math>, <math>V_{VLDH\_} = 6V</math>, unless otherwise noted)</b>						
Source Current Output Range		$V_{VLDH\_} = 0$ to $6V$ (Note 2)	0		20	mA
Source Current Offset		$V_{VLDH\_} = 300mV$ (1mA)	-20		+20	$\mu A$
Source Current Programming Gain		$V_{VLDH\_} = 0.3V, 5.4V$ (1mA, 18mA)	3.326	3.333	3.340	mA/V
Source Current Temperature Coefficient				-10		$\mu A/^\circ C$
Source Current Power-Supply Rejection Ratio		(Note 5)			$\pm 60$	$\mu A/V$
Source Current Linearity		$V_{VLDH\_} = 0V, 0.1V, 0.3V, 1.5V, 3V, 5.4V, 6V$ , relative to $0.3V$ and $5.4V$			$\pm 80$	$\mu A$
<b>SINK CURRENT (<math>V_{DUT\_} = 6V</math>, <math>V_{VCOM\_} = -1V</math>, <math>V_{VLDL\_} = 6V</math>, <math>V_{VLDH\_} = 0V</math>, unless otherwise noted)</b>						
Sink Current Output Range		$V_{VLDL\_} = 0$ to $6V$ (Note 2)	0		20	mA
Sink Current Offset		$V_{VLDL\_} = 300mV$ (1mA)	-20		+20	$\mu A$
Sink Current Programming Gain		$V_{VLDL\_} = 0.3V, 5.4V$ (1mA, 18mA)	3.326	3.333	3.340	mA/V
Sink Current Temperature Coefficient				10		$\mu A/^\circ C$
Sink Current Power-Supply Rejection Ratio	PSRR	(Note 5)			$\pm 60$	$\mu A/V$
Sink Current Linearity		$V_{VLDL\_} = 0V, 0.1V, 0.3V, 1.5V, 3V, 5.4V, 6V$ , relative to $0.3V$ and $5.4V$			$\pm 80$	$\mu A$
<b>AC CHARACTERISTICS (<math>Z_L = 50\Omega</math> to GND, <math>V_{VLDH\_} = V_{VLDL\_} = 6V</math>, <math>TMSEL\_ = LDDIS\_ = LDCAL\_ = 0</math>)</b>						
Transition Time to/from Inhibit via RCV/NRCV	$t_{EN}$	Measured from 50% crossing of RCV/NRVC to 10% level of output waveform; $V_{VCOM\_} = -1.5V$ and $1.5V$		2		ns
Spike During Enable/Disable Transition		$V_{VCOM\_} = 0V$ (Note 4)		200	300	mV
<b>TEMPERATURE MONITOR</b>						
Nominal Voltage		$T_J = +70^\circ C$ , $R_L \geq 10M\Omega$		3.43		V
Temperature Coefficient				10		$mV/^\circ C$
Output Resistance				15		$k\Omega$
<b>DIGITAL I/O</b>						
<b>DIFFERENTIAL CONTROL INPUTS (<math>DATA\_</math>, <math>NDATA\_</math>, <math>RCV\_</math>, <math>NRCV\_</math>)</b>						
Input High Voltage			-1.6		+3.5	V
Input Low Voltage			-2.0		+3.1	V
Differential Input Voltage			$\pm 0.15$		$\pm 1.0$	V

# Dual 1.1Gbps Pin Electronics with Integrated PMU and Level-Setting DACs

## ELECTRICAL CHARACTERISTICS (continued)

( $V_{CC} = 9.75V$ ,  $V_{EE} = -4.75V$ ,  $V_{DD} = 3.3V$ ,  $V_{HHP} = 17.5V$ ,  $V_{DHV\_} = 3V$ ,  $V_{DLV\_} = 0V$ ,  $V_{DTV\_} = 1.5V$ ,  $SC1 = SC0 = 0V$ ,  $V_{CPHV\_} = 7.2V$ ,  $V_{CPLV\_} = -2.2V$ ,  $V_{CTV\_} = 1.4V$ ,  $V_{BV\_} = 4V$ ,  $V_{DGS} = V_{GND} = 0V$ ,  $V_{CHV\_} = V_{IVMAX\_} = 2V$ ,  $V_{CLV\_} = V_{IVMIN\_} = 1V$ ,  $V_{COM\_} = 2.5V$ ,  $V_{LDHV\_} = 0V$ ,  $V_{LDLV\_} = 0V$ ,  $V_{IN\_} = 2.5V$ ,  $V_{VIOS} = 0V$ ,  $V_{VIOS} = 2.5V$ ,  $V_{CLAMPHI\_} = 5V$ ,  $V_{CLAMPLO\_} = 0V$ ,  $V_{HH\_} = 10V$ ,  $CDRP = 0b001$ ,  $RO = 0b1000$ ,  $HYST = 0b000$ ,  $Z_{LOAD} = 50\Omega$ ,  $T_J = +70^\circ C$  to an accuracy of  $\pm 15^\circ C$ , unless otherwise noted. All temperature coefficients are measured at  $T_J = +40^\circ C$  to  $+100^\circ C$ , unless otherwise noted.) (Note 1)

PARAMETER	SYMBOL	CONDITIONS	MIN	TYP	MAX	UNITS
Differential Termination Resistance		Between RCV and NRCV, DATA, and NDATA, tested at $I_{RCV\_}/I_{NRCV\_} = \pm 4mA$ (Note 50)	96		104	$\Omega$
<b>SINGLE-ENDED CONTROL INPUTS (<math>\overline{CS}</math>, SCLK, DIN, <math>\overline{RST}</math>, <math>\overline{LOAD}</math>, <math>\overline{ENVHHP\_}</math>, <math>\overline{LLEAKP\_}</math>, <math>\overline{HIZMEASP\_}</math>)</b>						
Input High			$2/3 \times V_{DD}$		$V_{DD}$	V
Input Low			-0.1		$1/3 \times V_{DD}$	V
Input Bias Current			-25		+25	$\mu A$
<b>SINGLE-ENDED OUTPUT (DOUT)</b>						
Output High		$I_{OH} = 25\mu A$	$V_{DD} - 0.15$			V
Output Low		$I_{OL} = -25\mu A$			DGND + 0.15	V
<b>SERIAL PORT TIMING</b>						
SCLK Frequency	f				50	MHz
SCLK Pulse-Width High	$t_{CH}$		8			ns
SCLK Pulse-Width Low	$t_{CL}$		8			ns
$\overline{CS}$ Low to SCLK High Setup	$t_{CSS0}$		3.5			ns
SCLK High to $\overline{CS}$ Low Hold	$t_{CSH0}$		3.5			ns
$\overline{CS}$ High to SCLK High Setup	$t_{CSS1}$		3.5			ns
SCLK High to $\overline{CS}$ High Hold	$t_{CSH1}$		3.5			ns
DIN to SCLK High Setup	$t_{DS}$		3.5			ns
DIN to SCLK High Hold	$t_{DH}$		3.5			ns
$\overline{CS}$ High Pulse Width	$t_{CSWH}$		40			ns
$\overline{LOAD}$ Low Pulse Width	$t_{LDW}$		20			ns
$\overline{RST}$ Low Pulse Width	$t_{RST}$		20			ns
$\overline{CS}$ High to $\overline{LOAD}$ Low Hold Time	$t_{CSHLD}$		20			ns
SCLK to DOUT Delay	$t_{DO}$				40	ns
<b>COMMON FUNCTIONS</b>						
Operating Voltage Range		(Note 2)	-1.5		+13.0	V
DUT_ High-Impedance Leakage		$V_{DUT\_} = 0V, 1.5V, 3V$	-2		+2	$\mu A$
		$V_{CLV\_} = V_{CHV\_} = 6.5V, V_{DUT\_} = -1.5V$	-5		+5	
		$V_{CLV\_} = V_{CHV\_} = -1.5V, V_{DUT\_} = 6.5V$	-5		+5	

# Dual 1.1Gbps Pin Electronics with Integrated PMU and Level-Setting DACs

MAX9979

## ELECTRICAL CHARACTERISTICS (continued)

( $V_{CC} = 9.75V$ ,  $V_{EE} = -4.75V$ ,  $V_{DD} = 3.3V$ ,  $V_{HHP} = 17.5V$ ,  $V_{DHV\_} = 3V$ ,  $V_{DLV\_} = 0V$ ,  $V_{DTV\_} = 1.5V$ ,  $SC1 = SC0 = 0V$ ,  $V_{CPHV\_} = 7.2V$ ,  $V_{CPLV\_} = -2.2V$ ,  $V_{CTV\_} = 1.4V$ ,  $V_{BV\_} = 4V$ ,  $V_{DGS} = V_{GND} = 0V$ ,  $V_{CHV\_} = V_{IVMAX\_} = 2V$ ,  $V_{CLV\_} = V_{IVMIN\_} = 1V$ ,  $V_{COM\_} = 2.5V$ ,  $V_{LDHV\_} = 0V$ ,  $V_{LDLV\_} = 0V$ ,  $V_{IN\_} = 2.5V$ ,  $V_{VIOS} = 0V$ ,  $V_{VIOS} = 2.5V$ ,  $V_{CLAMPHI\_} = 5V$ ,  $V_{CLAMPLO\_} = 0V$ ,  $V_{HH\_} = 10V$ ,  $CDRP = 0b001$ ,  $RO = 0b1000$ ,  $HYST = 0b000$ ,  $Z_{LOAD} = 50\Omega$ ,  $T_J = +70^\circ C$  to an accuracy of  $\pm 15^\circ C$ , unless otherwise noted. All temperature coefficients are measured at  $T_J = +40^\circ C$  to  $+100^\circ C$ , unless otherwise noted.) (Note 1)

PARAMETER	SYMBOL	CONDITIONS	MIN	TYP	MAX	UNITS
DUT_ Low-Leak Mode Leakage		$V_{DUT\_} = 0V, 1.5V, 3V, T_J < +90^\circ C$	-10		+10	nA
		$V_{CLV\_} = V_{CHV\_} = 6.5V, V_{DUT\_} = -1.5V, T_J < +90^\circ C$	-10		+10	
		$V_{CLV\_} = V_{CHV\_} = -1.5V, V_{DUT\_} = 6.5V, T_J < +90^\circ C$	-10		+10	
DUT_ Combined Capacitance		Driver in terminate mode (Note 4)		3.4	4.3	pF
		Driver in high impedance, PMU in high impedance		8		
Low-Leakage Enable Time		$\overline{LLEAKP\_}$ low to DUT_ = low leak		20		$\mu s$
Low-Leakage Disable Time		$\overline{LLEAKP\_}$ high to normal operation		20		$\mu s$
<b>POWER SUPPLY</b>						
Positive Supply Voltage	$V_{CC}$		9.5	9.75	10.5	V
Negative Supply Voltage	$V_{EE}$		-5.2	-4.75	-4.5	V
Logic Supply Voltage	$V_{DD}$		2.7	3.3	5.0	V
$V_{HHP}$ Supply Voltage	$V_{HHP}$		17	17.5	18	V
Positive Supply Current	$I_{CC}$	(Note 51)		120	135	mA
Negative Supply Current	$I_{EE}$	(Note 51)		245	260	mA
Logic Supply Current	$I_{DD}$	(Note 51)		4.5	7	mA
$V_{HHP}$ Supply Current	$I_H$	(Note 51)		1.5	2.0	mA
		VHH mode, no load		45	50	
Power Dissipation per Channel		Includes CTV power at $V_{CTV1} = V_{CTV2} = 1.4V$ (Note 51)		1.2	1.35	W
<b>ANALOG INPUTS</b>						
<b>DUT GROUND SENSE</b>						
Input Range	$V_{DGS}$	Relative to AGND (Note 52)	-150		+150	mV
Input Bias Current		$V_{DGS} = 0V$	-10		+10	$\mu A$
Gain		DHV_, DLV_, DTV_, CPHV_, CPLV_, VHH_	0.985	0.990	1.005	V/V
		All other levels and MEAS_ output	0.995	1.000	1.005	
<b>2.5V REFERENCE</b>						
Nominal Voltage	$V_{REF}$	(Notes 53, 54)		2.5		V
Input Bias Current			-2		+2	$\mu A$
<b>ANALOG BUS (<math>V_{DUT\_} = -1.5V</math> to <math>+6.5V</math>, PMU-F = PMU-S = <math>-1.5V</math> to <math>+6.5V</math>, unless otherwise noted)</b>						
PMU-F Switch		$I_{SWITCH} = \pm 2.5mA, V_{DUT\_} = -1.25V, 2.50V, 6.25V$			100	$\Omega$
PMU-S Switch		$I_{SWITCH} = \pm 100\mu A, V_{DUT\_} = -1.25V, 2.50V, 6.25V$			2.5	k $\Omega$

# Dual 1.1Gbps Pin Electronics with Integrated PMU and Level-Setting DACs

## ELECTRICAL CHARACTERISTICS (continued)

( $V_{CC} = 9.75V$ ,  $V_{EE} = -4.75V$ ,  $V_{DD} = 3.3V$ ,  $V_{HHP} = 17.5V$ ,  $V_{DHV\_} = 3V$ ,  $V_{DLV\_} = 0V$ ,  $V_{DTV\_} = 1.5V$ ,  $SC1 = SC0 = 0V$ ,  $V_{CPHV\_} = 7.2V$ ,  $V_{CPLV\_} = -2.2V$ ,  $V_{CTV\_} = 1.4V$ ,  $V_{BV\_} = 4V$ ,  $V_{DGS} = V_{GND} = 0V$ ,  $V_{CHV\_} = V_{IVMAX\_} = 2V$ ,  $V_{CLV\_} = V_{IVMIN\_} = 1V$ ,  $V_{COM\_} = 2.5V$ ,  $V_{LDHV\_} = 0V$ ,  $V_{LDLV\_} = 0V$ ,  $V_{IN\_} = 2.5V$ ,  $V_{VIOS} = 0V$ ,  $V_{VIOS} = 2.5V$ ,  $V_{CLAMPHI\_} = 5V$ ,  $V_{CLAMPLO\_} = 0V$ ,  $V_{HH\_} = 10V$ ,  $CDRP = 0b001$ ,  $RO = 0b1000$ ,  $HYST = 0b000$ ,  $Z_{LOAD} = 50\Omega$ ,  $T_J = +70^\circ C$  to an accuracy of  $\pm 15^\circ C$ , unless otherwise noted. All temperature coefficients are measured at  $T_J = +40^\circ C$  to  $+100^\circ C$ , unless otherwise noted.) (Note 1)

PARAMETER	SYMBOL	CONDITIONS	MIN	TYP	MAX	UNITS
PMU-S Switch		$I_{SWITCH} = \pm 10\mu A$ , $V_{DUT\_} = 6.5V$ to $13V$ , $V_{PMU-F} = V_{PMU-S} = 6.5V$ to $13V$ for $V_{HH}$ level calibration			5	$k\Omega$
PMU-F Path Current					$\pm 30$	mA
PMU-F, PMU-S On-Leakage		F and S Independent, other channel switches off	-10	$\pm 5$	+10	nA
PMU-F, PMU-S Off-Leakage			-10	$\pm 1$	+10	nA
<b>DIFFERENTIAL COMPARATOR (DIFFERENTIAL_ = 1)</b>						
<b>DC CHARACTERISTICS (<math>V_{CLV\_} = V_{CHV\_} = 0V</math>, unless otherwise noted)</b>						
Input-Voltage Range	$V_{DUT0}$ , $V_{DUT1}$	(Notes 22, 55)	-1.5		+6.5	V
Differential Threshold Voltage Range	CLV, CHV	Levels may be safely programmed beyond this range	-1		+1	V
Differential Input Voltage		(Notes 22, 23)	-8		+8	V
Offset Error		$V_{DUT\_} = 0V$	-5		+5	mV
Gain		$V_{DUTn} = 0V$ , $V_{DUTm} = -1V, 1V$	0.998	1	1.002	V/V
Linearity Error Relative to Straight Line from -1V to +1V		$V_{DUTn} = 0V$ , $V_{DUTm} = -1V, -0.5V, 0, 0.5V, 1V$	-5		+5	mV
Hysteresis		<b>HYST0</b>	<b>HYST1</b>	<b>HYST2</b>		mV
		0	0	0	0	
		0	0	1	2	
		0	1	0	4	
		0	1	1	6	
		1	0	0	8	
		1	0	1	10	
		1	1	0	12	
1	1	1	15			
Offset Temperature Coefficient		$V_{DUTn} = 0V$ and $V_{DUTm} = -1V, 1V$ (Note 4)	-150		+150	$\mu V/^\circ C$
DC Power-Supply Rejection Ratio		$V_{DUT\_} = 1.5V$ (Note 27)	50	66		dB
Common-Mode Rejection Ratio	CMRR	$V_{DUT\_} = -1.5V$ and $6.5V$ , $V_{CLV\_} = V_{CHV\_} = 0V$ (Note 25)	50	55		dB
<b>AC CHARACTERISTICS (<math>V_{CHV\_} = V_{CLV\_} = 0V</math>, driver terminated, unless otherwise noted) (Note 4)</b>						
Minimum Pulse Width		(Note 31)		0.5	0.65	ns
Propagation Delay			0.5	1	1.5	ns
Propagation-Delay Match H/L vs. L/H, Individual Comparator			-25		+25	ps

# Dual 1.1Gbps Pin Electronics with Integrated PMU and Level-Setting DACs

MAX9979

## ELECTRICAL CHARACTERISTICS (continued)

( $V_{CC} = 9.75V$ ,  $V_{EE} = -4.75V$ ,  $V_{DD} = 3.3V$ ,  $V_{HHP} = 17.5V$ ,  $V_{DHFV} = 3V$ ,  $V_{DLV} = 0V$ ,  $V_{DTV} = 1.5V$ ,  $SC1 = SC0 = 0V$ ,  $V_{CPHV} = 7.2V$ ,  $V_{CPLV} = -2.2V$ ,  $V_{CTV} = 1.4V$ ,  $V_{BV} = 4V$ ,  $V_{DGS} = V_{GND} = 0V$ ,  $V_{CHV} = V_{IVMAX} = 2V$ ,  $V_{CLV} = V_{IVMIN} = 1V$ ,  $V_{COM} = 2.5V$ ,  $V_{LDHFV} = 0V$ ,  $V_{LDLV} = 0V$ ,  $V_{IN} = 2.5V$ ,  $V_{VIOS} = 0V$ ,  $V_{IIOS} = 2.5V$ ,  $V_{CLAMPHI} = 5V$ ,  $V_{CLAMPLO} = 0V$ ,  $V_{HH} = 10V$ ,  $CDRP = 0b001$ ,  $RO = 0b1000$ ,  $HYST = 0b000$ ,  $Z_{LOAD} = 50\Omega$ ,  $T_J = +70^\circ C$  to an accuracy of  $\pm 15^\circ C$ , unless otherwise noted. All temperature coefficients are measured at  $T_J = +40^\circ C$  to  $+100^\circ C$ , unless otherwise noted.) (Note 1)

PARAMETER	SYMBOL	CONDITIONS	MIN	TYP	MAX	UNITS
Change in Propagation Delay vs. Duty Cycle		500mV swing, 250mV overdrive, 2ns to 23ns pulse width, relative to PW = 12.5ns	-45		+45	ps
Propagation Delay vs. Common-Mode Voltage		$V_{SWING} = 200mV$ , 100mV overdrive, common-mode voltage = -1.4V to +6.4V (Note 32)			70	ps <sub>p-p</sub>
Propagation-Delay Temperature Coefficient				$\pm 3$		ps/ $^\circ C$
Propagation Delay vs. Slew Rate		1V/ns to 6V/ns, relative to 2V/ns			$\pm 50$	ps
Cable-Droop Compensation		1V swing, rise/fall time = 500ps	CDRP = 0b000	0		%
			CDRP = 0b111	10		
<b>DRIVER VHH</b>						
<b>DC CHARACTERISTICS</b>						
Output-Voltage Range	VHH		0		13	V
DC Output Current		VHH <sub>-</sub> = 13V, I <sub>DUT</sub> = 10mA, V <sub>DUT</sub> > 12.25V	+10			mA
		VHH <sub>-</sub> = 0V, I <sub>DUT</sub> = -10mA, V <sub>DUT</sub> < 0.75V			-10	
Current Limit		VHH <sub>-</sub> = 13V, V <sub>DUT</sub> = 0V and VHH <sub>-</sub> = 0V, V <sub>DUT</sub> = 13V	$\pm 11$		$\pm 25$	mA
Offset Voltage		VHH <sub>-</sub> = 8V			$\pm 30$	mV
Gain		VHH <sub>-</sub> = 8V, 12V	0.998	1	1.002	V/V
Linearity Relative to 8V, 12V		VHH <sub>-</sub> = 7V, 8V, 10V, 12V, 13V			$\pm 10$	mV
Linearity Relative to 2V, 12V		VHH <sub>-</sub> = 0, 2V, 4V, 8V, 12V, 13V			$\pm 30$	mV
Output Resistance		I <sub>DUT</sub> = $\pm 2mA$ , VHH <sub>-</sub> = 1V			75	$\Omega$
Output-Voltage Temperature Coefficient		VHH <sub>-</sub> = 7V to 13V (Note 4)		$\pm 75$	$\pm 500$	$\mu V/^\circ C$
<b>AC CHARACTERISTICS (R<sub>L</sub> <math>\geq</math> 10M<math>\Omega</math>, C<sub>DUT</sub> = 100pF)</b>						
VHH Rise/Fall Times		V <sub>DHFV</sub> = 3V, VHH <sub>-</sub> = 13V, 10% to 90%			170	ns
VHH Overshoot (Note 4)		V <sub>DHFV</sub> = 3V to VHH <sub>-</sub> = 13V rise			150	mV
		VHH <sub>-</sub> = 13V to V <sub>DHFV</sub> = 3V fall			200	
<b>LEVEL DACs</b>						
Settling Time		Full-scale transition to within 5mV		20		$\mu s$
Differential Nonlinearity		I <sub>SOURCE</sub> (VLDH <sub>-</sub> ), I <sub>SINK</sub> (VLDL <sub>-</sub> )			$\pm 3.5$	$\mu A$
		VHH <sub>-</sub> , IIOS			$\pm 2$	mV
		All other levels			$\pm 1$	mV

# Dual 1.1Gbps Pin Electronics with Integrated PMU and Level-Setting DACs

## ELECTRICAL CHARACTERISTICS (continued)

( $V_{CC} = 9.75V$ ,  $V_{EE} = -4.75V$ ,  $V_{DD} = 3.3V$ ,  $V_{HHP} = 17.5V$ ,  $V_{DHV\_} = 3V$ ,  $V_{DLV\_} = 0V$ ,  $V_{DTV\_} = 1.5V$ ,  $SC1 = SC0 = 0V$ ,  $V_{CPHV\_} = 7.2V$ ,  $V_{CPLV\_} = -2.2V$ ,  $V_{CTV\_} = 1.4V$ ,  $V_{BV\_} = 4V$ ,  $V_{DGS} = V_{GND} = 0V$ ,  $V_{CHV\_} = V_{IVMAX\_} = 2V$ ,  $V_{CLV\_} = V_{IVMIN\_} = 1V$ ,  $V_{COM\_} = 2.5V$ ,  $V_{LDHV\_} = 0V$ ,  $V_{LDLV\_} = 0V$ ,  $V_{IN\_} = 2.5V$ ,  $V_{VIOS} = 0V$ ,  $V_{VIOS} = 2.5V$ ,  $V_{CLAMPHI\_} = 5V$ ,  $V_{CLAMPLO\_} = 0V$ ,  $V_{HH\_} = 10V$ ,  $CDRP = 0b001$ ,  $RO = 0b1000$ ,  $HYST = 0b000$ ,  $Z_{LOAD} = 50\Omega$ ,  $T_J = +70^\circ C$  to an accuracy of  $\pm 15^\circ C$ , unless otherwise noted. All temperature coefficients are measured at  $T_J = +40^\circ C$  to  $+100^\circ C$ , unless otherwise noted.) (Note 1)

- Note 1:** Unless otherwise specified, all minimum and maximum specifications are production tested. All other specification test limits are guaranteed by design. All tests are performed at nominal supply voltages and after gain and offset calibration, unless otherwise specified.
- Note 2:** Guaranteed by the associated linearity test.
- Note 3:** Change in offset at any voltage over the operating range. Specification includes both gain and offset temperature effects. Limits have been simulated over the entire operating range and verified at worst-case conditions ( $V_{DHV\_} - V_{DLV\_} > 200mV$ ).
- Note 4:** Guaranteed by design and characterization.
- Note 5:**  $V_{CC}$  and  $V_{EE}$  independently varied over their full range.
- Note 6:**  $DATA\_ = 1V$ ,  $V_{DHV\_} = 3V$ ,  $V_{DLV\_} = 0V$ ,  $V_{DTV\_} = 1.5V$ ,  $I_{OUT} = \pm 30mA$ . Different values within the range of  $48\Omega$  to  $52\Omega$  are available by custom trimming (contact factory).
- Note 7:** Resistance measurements are made using  $\pm 2.5mA$  current changes in the loading instrument about the noted value. Absolute value of the difference in measured resistance at the specified points, tested separately for each current polarity.
- Note 8:** Rise time, unless otherwise specified for the differential inputs  $DATA\_$  and  $RCV\_$ , is 250ps (10% to 90%) at 40MHz. (These conditions are for bench characterization. Final test conditions may differ from bench.)
- Note 9:**  $\pm 8V$  step into AC-coupled  $10\Omega$  load. Current supplied for a minimum of 10ns. Guaranteed by design to be greater than or equal to DC drive current.
- Note 10:**  $V_{DTV\_} = 1.5V$ ,  $R_S = 50\Omega$ . External signal driven into a transmission line to produce a 0 to 3V edge at the comparator input with a 600ps rise time (10% to 90%). Measurement point is at the comparator input.
- Note 11:** Measured between the 90% point of the driver output (relative to its final value) and the waveform settling to within the specified limit.
- Note 12:** Propagation delays are measured from the crossing point of the differential input signals to the 50% point of expected output swing.
- Note 13:** Average of two measurements for propagation-delay match,  $t_{LH}$  vs.  $t_{HL}$ .
- Note 14:** Four measurements are made:  $DHV\_$  to high impedance,  $DLV\_$  to high impedance, high impedance to  $DHV\_$ , and high impedance to  $DLV\_$ . The worst of the four measurements is reported.
- Note 15:** Average of four measurements of propagation-delay match, drive to high impedance vs. high impedance to drive. Measured from the crossing point of  $RCV/NRCV$  to the 50% point of the output waveform.
- Note 16:** Average of four measurements for propagation-delay match, drive to term vs. term to drive. Measured from the crossing point of  $RCV/NRCV$  to the 50% point of the output waveform.
- Note 17:** Four measurements are made:  $DHV\_$  to  $DTV\_$ ,  $DLV\_$  to  $DTV\_$ ,  $DTV\_$  to  $DHV\_$ , and  $DTV\_$  to  $DLV\_$ . The worst-case difference is reported.
- Note 18:** Propagation-delay change is reported with respect to a 5ns pulse width.
- Note 19:** At this pulse width, the output reaches at least 95% of its nominal (DC) amplitude. The pulse width is measured at  $DATA\_$  and  $NDATA\_$ .
- Note 20:** Maximum data rate in transitions/second. A waveform that reaches at least 95% of its programmed amplitude may be generated at half of this frequency.
- Note 21:** Maximum data rate in transitions/second. A waveform that reaches at least 90% of its programmed amplitude may be generated at half of this frequency.
- Note 22:** The comparators tolerate the  $V_{HH}$  produced by the driver; however, the specifications only apply to the  $-1.5V$  to  $+6.5V$  input range.
- Note 23:** This specification is implicitly tested, by meeting the high-impedance leakage specification.
- Note 24:** Change in offset at any voltage over operating range. Includes both gain (CMRR) and offset temperature effects.
- Note 25:** Change in offset voltage over the input range.
- Note 26:** Relative to straight line between 0 and 3V.
- Note 27:** Change in offset voltage with power supplies independently varied over their full range. Both high and low comparators are tested.
- Note 28:** All propagation delays measured from  $V_{DUT\_}$  crossing calibrated  $CHV\_/CLV\_$  threshold to crossing point of differential outputs.

# Dual 1.1Gbps Pin Electronics with Integrated PMU and Level-Setting DACs

MAX9979

## ELECTRICAL CHARACTERISTICS (continued)

( $V_{CC} = 9.75V$ ,  $V_{EE} = -4.75V$ ,  $V_{DD} = 3.3V$ ,  $V_{HHP} = 17.5V$ ,  $V_{DHV\_} = 3V$ ,  $V_{DLV\_} = 0V$ ,  $V_{DTV\_} = 1.5V$ ,  $SC1 = SC0 = 0V$ ,  $V_{CPHV\_} = 7.2V$ ,  $V_{CPLV\_} = -2.2V$ ,  $V_{CTV\_} = 1.4V$ ,  $V_{BV\_} = 4V$ ,  $V_{DGS} = V_{GND} = 0V$ ,  $V_{CHV\_} = V_{IVMAX\_} = 2V$ ,  $V_{CLV\_} = V_{IVMIN\_} = 1V$ ,  $V_{COM\_} = 2.5V$ ,  $V_{LDHV\_} = 0V$ ,  $V_{LDLV\_} = 0V$ ,  $V_{IN\_} = 2.5V$ ,  $V_{VIOS} = 0V$ ,  $V_{VIOS} = 2.5V$ ,  $V_{CLAMPHI\_} = 5V$ ,  $V_{CLAMPLO\_} = 0V$ ,  $V_{HH\_} = 10V$ ,  $CDRP = 0b001$ ,  $RO = 0b1000$ ,  $HYST = 0b000$ ,  $Z_{LOAD} = 50\Omega$ ,  $T_J = +70^{\circ}C$  to an accuracy of  $\pm 15^{\circ}C$ , unless otherwise noted. All temperature coefficients are measured at  $T_J = +40^{\circ}C$  to  $+100^{\circ}C$ , unless otherwise noted.) (Note 1)

**Note 29:** All delay specifications are measured with  $DUT\_$  (comparator input) as the reference.

**Note 30:** 40MHz, 0 to 1V input to comparator, reference = 0.5V, 50% duty cycle, 250ps rise/fall time,  $Z_S = 50\Omega$ , driver in term mode with  $V_{DTV\_} = 0V$ , and hysteresis disabled, unless otherwise specified.

**Note 31:** At this pulse width, the output reaches at least 90% of its nominal peak-to-peak swing. The pulse width is measured at the crossing points of the differential outputs. 250ps rise/fall time at  $DUT\_$ . Timing dispersion specifications are not guaranteed.

**Note 32:**  $V_{DUT\_} = 200mV_{P-P}$ , rise/fall time = 150ps, overdrive = 100mV,  $V_{DTV\_} = V_{CM}$ . Valid for common-mode ranges where the signal does not exceed the operating range. Specification is worst case (slowest-fastest) over the specified range.

**Note 33:** For any input slew rate up to 6V/ns, no unusual behavior should be exhibited (i.e., glitching, changing polarity, etc.).

**Note 34:** Input to comparator is 40MHz at 0 to 1V, 50% duty cycle, 250ps 10% to 90% rise time. EQ bandwidth =  $0.22/(t_{TCMP}^2 + t_{TINPUT}^2)^{1/2}$  where  $t_{TINPUT}$  and  $t_{TCMP}$  are the 20% to 80% transition time of the comparator input and reconstructed output.

**Note 35:** Resistance measurements are made using  $\pm 2.5mA$  current changes in the loading instrument. Value reported is the absolute value of the difference in measured resistance over the specified range, tested separately for each current polarity.

**Note 36:** Stimulus is 0 to 3V, 2.5V/ns square wave from far end of 3ns transmission line with  $R_S = 25\Omega$ , clamps set to 0 and 3V.

**Note 37:** Change in offset over the entire operating range. Includes both gain and offset temperature effects.

**Note 38:** Interpretation of errors are expressed in terms of %FSR (percent of full-scale range) as a percentage of the end-point-to-end-point range (i.e., for the  $\pm 2mA$  range, the full-scale range = 4mA and a 1% error = 40 $\mu A$ ).

**Note 39:** With clamps enabled, the linear  $DUT\_$  current range for force voltage is defined by the clamp-current-range specification, and the linear  $DUT\_$  voltage range for force current is defined by the linear  $FI_{DUT\_}$  range specification.

**Note 40:** For currents greater than  $+FSR/2$ ,  $V_{MEAS}$  is greater than  $V_{VIOS} + 4V$  and for currents less than  $-FSR/2$ ,  $V_{MEAS}$  is less than  $V_{VIOS} - 4V$ .

**Note 41:** This current is supplied by the driver.

**Note 42:**  $V_{VIOS}$  may be programmed to greater than 1.5V to a maximum value of 2.5V; however, the maximum valid  $V_{DUT\_}$  value must be reduced below 6.5V, as the maximum MEAS output is limited to 8V. Because  $V_{MEAS} = V_{DUT\_} + V_{VIOS}$ , then  $V_{DUT\_MAX} = 8V - V_{VIOS}$  when  $V_{VIOS} > 1.5V$ .

**Note 43:** Guaranteed by driver  $V_{HH\_}$  and  $DLV\_$  linearity tests.

**Note 44:**  $IV_{MAX}$  and  $IV_{MIN}$  do not have separate calibration registers for MI and MV modes. Specifications apply with calibration for each mode.

**Note 45:** Guaranteed by the associated accuracy test.

**Note 46:** The digital interface is compatible with  $2.7V \leq V_{DD} \leq 5V$  CMOS logic.

**Note 47:** See the *Typical Operating Characteristics* section.

**Note 48:** FIMV settling times are a function of  $CDUT\_$  and  $RRANGE$ . Increased  $DUT\_$  capacitance will increase settling time.

**Note 49:** The propagation delay time is guaranteed only over the force-voltage output range. Propagation delay is measured by holding  $V_{SENSE\_}$  steady and transitioning  $IV_{MAX\_}$  or  $IV_{MIN\_}$ .

**Note 50:** Default configuration has internal 100 $\Omega$  resistors between DATA and NDATA, RCV and NRCV. Resistor terminations from DATA, NDATA, RCV, and NRCV to a separate pin are available by special request.

**Note 51:** At nominal supply voltages. Total current for dual device.  $R_L \geq 10M\Omega$ .

**Note 52:** Increasing DGS beyond 0V requires a proportional increase in the minimum supply levels. Specified ranges for all DAC output levels are defined with respect to DGS.

**Note 53:** The error of the external 2.5V reference impacts the accuracy of the DAC levels; a 1% error in the 2.5V reference will translate to a 1% error in the DAC level gain. Use a precision voltage reference, such as the MAX6225.

**Note 54:** Generate the 2.5V external reference with respect to DGS ( $DUT$  ground sense).

**Note 55:** Guaranteed by associated  $CMRR\_$  test.

**Note 56:** The comparator outputs are normally source side-terminated with 50 $\Omega$  on-die to  $CTV\_$  and at the receive side of the transmission path. The comparator outputs are tested with the 50 $\Omega$  on-die source resistors only with limits relative to  $CTV\_$  twice the values indicated.

# Dual 1.1Gbps Pin Electronics with Integrated PMU and Level-Setting DACs

## Typical Operating Characteristics

( $V_{CC} = 9.75V$ ,  $V_{EE} = -4.75V$ ,  $V_{DD} = 3.3V$ ,  $V_{HHP} = 17.5V$ ,  $V_{DHV\_} = 3V$ ,  $V_{DLV\_} = 0V$ ,  $V_{DTV\_} = 1.5V$ ,  $SC1 = SC0 = 0$ ,  $V_{CPHV\_} = 7.2V$ ,  $V_{CPLV\_} = -2.2V$ ,  $R_T = 50\Omega \parallel 1pF$ ,  $C_L = 100pF$ ,  $CTV\_ = 1.4V$ ,  $T_J = +70^\circ C$ , unless otherwise specified. All temperature coefficients are measured at  $T_J = +40^\circ C$  to  $+100^\circ C$ .)

**DRIVER SMALL-SIGNAL RESPONSE**

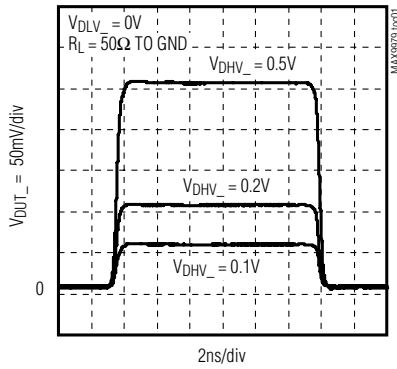

**DRIVER LARGE-SIGNAL RESPONSE**

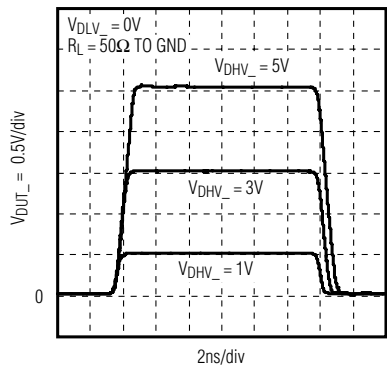

**DRIVER TRAILING-EDGE TIMING ERROR vs. PULSE WIDTH**

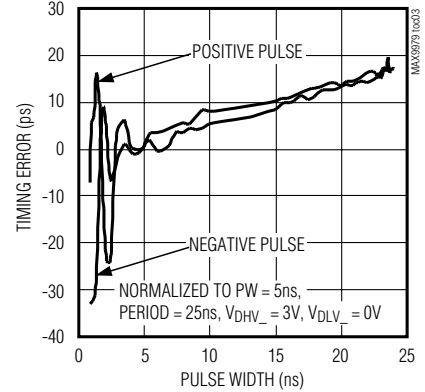

**DRIVER TIME DELAY vs. COMMON-MODE VOLTAGE**

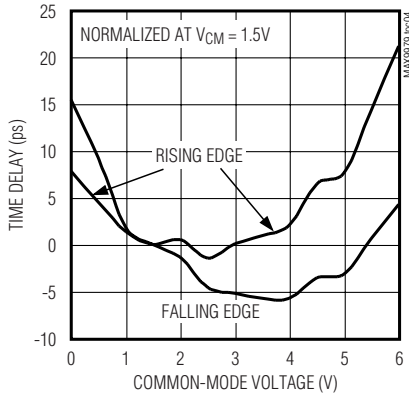

**DRIVER-TO-TERM TRANSITION**

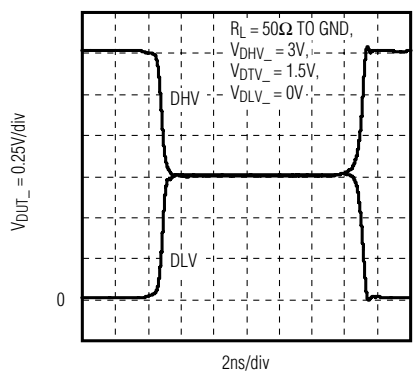

**DRIVER TO HIGH-IMPEDANCE TRANSITION**

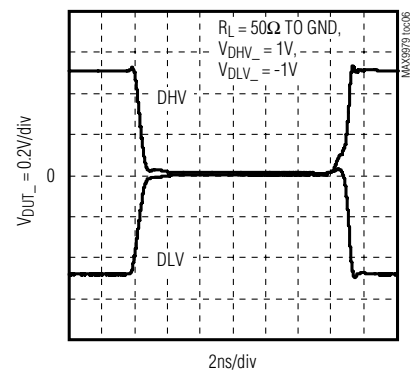

**DRIVER LINEARITY ERROR vs. OUTPUT VOLTAGE**

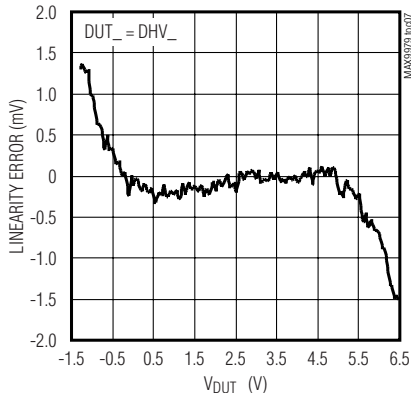

**DRIVER LINEARITY ERROR vs. OUTPUT VOLTAGE**

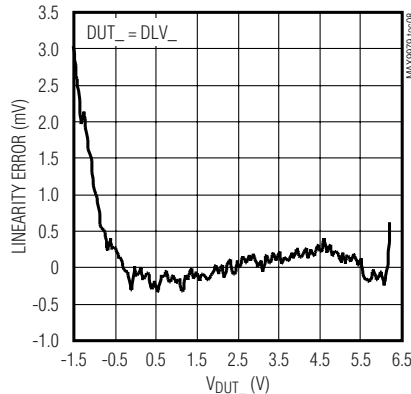



# Dual 1.1Gbps Pin Electronics with Integrated PMU and Level-Setting DACs

MAX9979

## Typical Operating Characteristics (continued)

( $V_{CC} = 9.75V$ ,  $V_{EE} = -4.75V$ ,  $V_{DD} = 3.3V$ ,  $V_{HHP} = 17.5V$ ,  $V_{DHV\_} = 3V$ ,  $V_{DLV\_} = 0V$ ,  $V_{DTV\_} = 1.5V$ ,  $SC1 = SC0 = 0$ ,  $V_{CPHV\_} = 7.2V$ ,  $V_{CPLV\_} = -2.2V$ ,  $R_T = 50\Omega \parallel 1pF$ ,  $C_L = 100pF$ ,  $CTV\_ = 1.4V$ ,  $T_J = +70^\circ C$ , unless otherwise specified. All temperature coefficients are measured at  $T_J = +40^\circ C$  to  $+100^\circ C$ .)

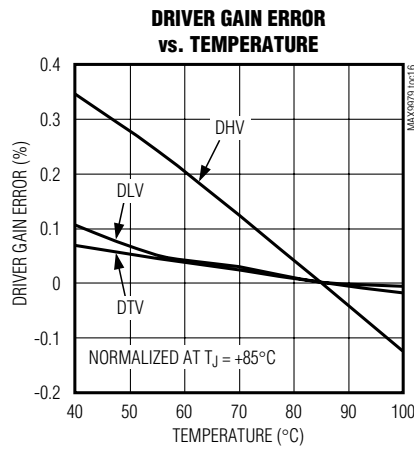
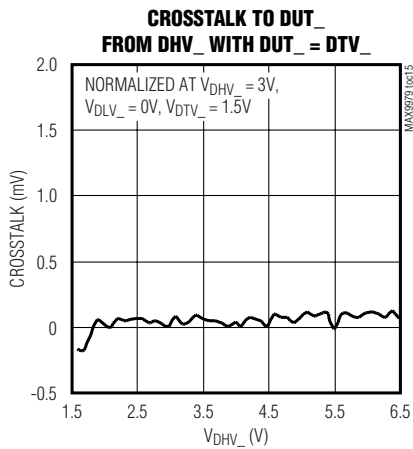
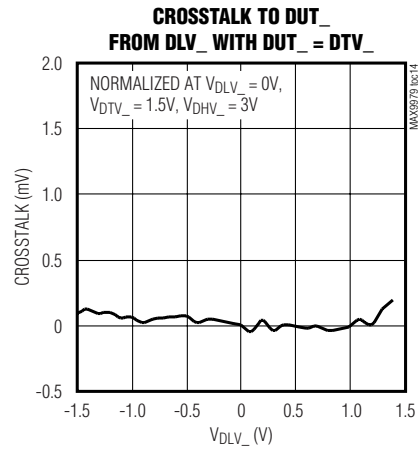
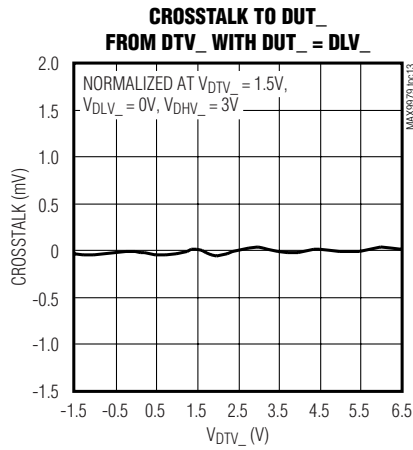
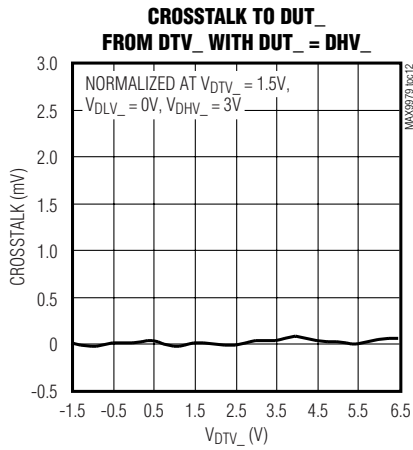
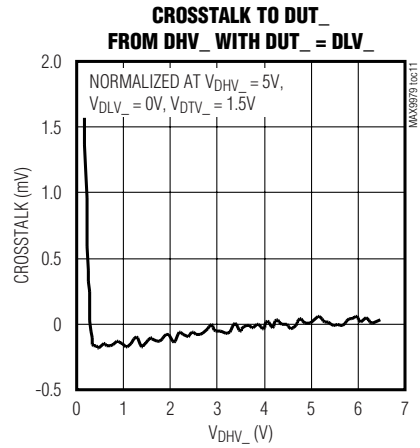
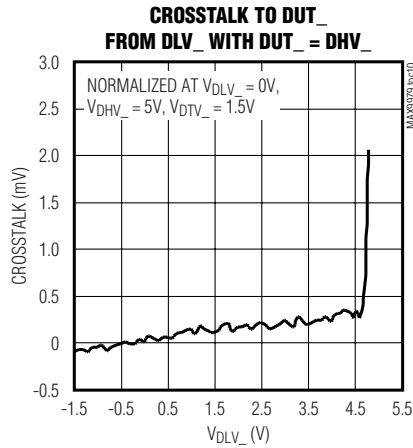
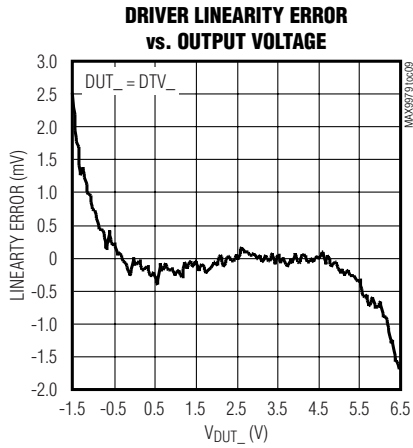

# Dual 1.1Gbps Pin Electronics with Integrated PMU and Level-Setting DACs

## Typical Operating Characteristics (continued)

( $V_{CC} = 9.75V$ ,  $V_{EE} = -4.75V$ ,  $V_{DD} = 3.3V$ ,  $V_{HHP} = 17.5V$ ,  $V_{DHV\_} = 3V$ ,  $V_{DLV\_} = 0V$ ,  $V_{DTV\_} = 1.5V$ ,  $SC1 = SC0 = 0$ ,  $V_{CPHV\_} = 7.2V$ ,  $V_{CPLV\_} = -2.2V$ ,  $R_T = 50\Omega \parallel 1pF$ ,  $C_L = 100pF$ ,  $CTV\_ = 1.4V$ ,  $T_J = +70^\circ C$ , unless otherwise specified. All temperature coefficients are measured at  $T_J = +40^\circ C$  to  $+100^\circ C$ .)

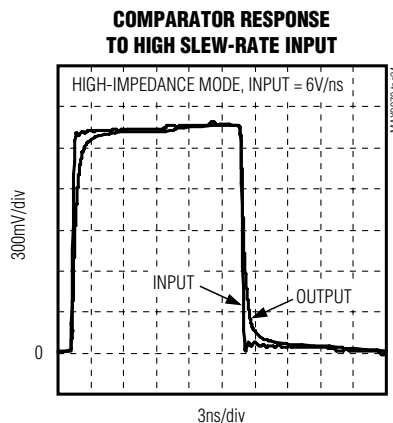
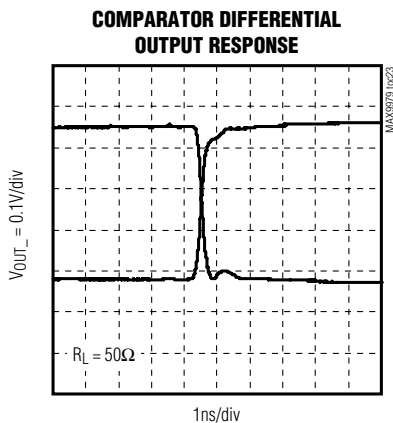
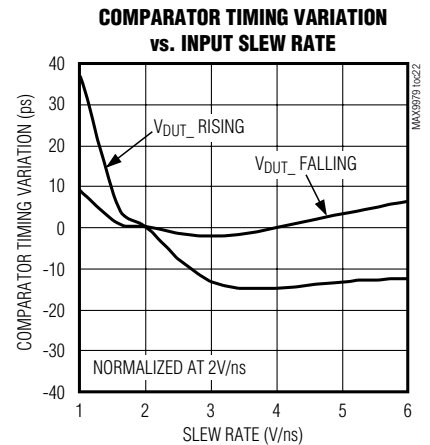
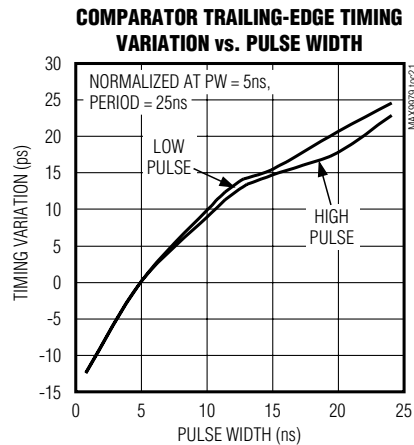
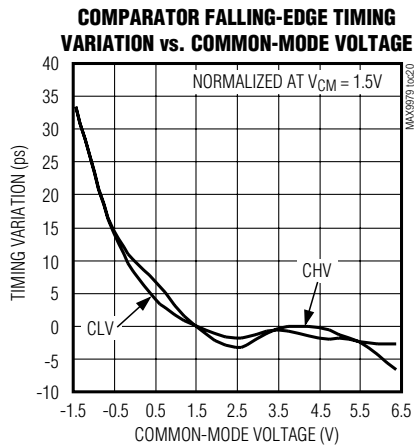
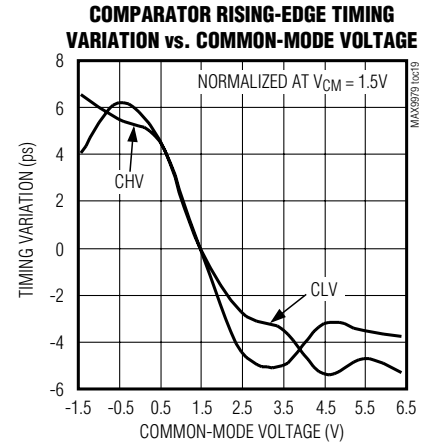
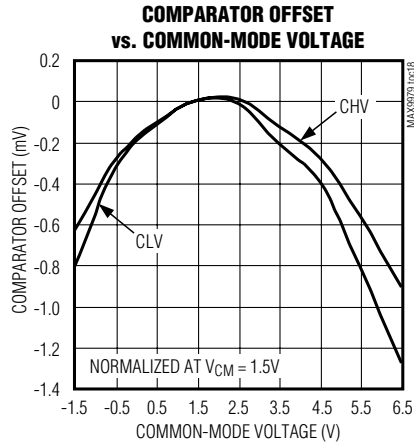
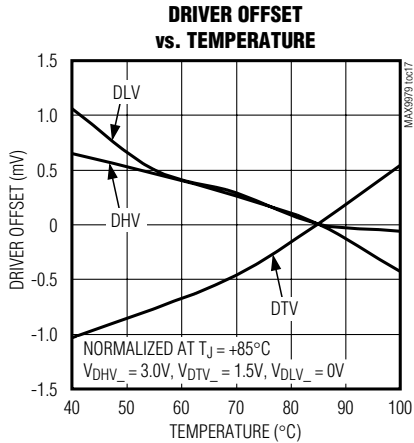

# Dual 1.1Gbps Pin Electronics with Integrated PMU and Level-Setting DACs

MAX9979

## Typical Operating Characteristics (continued)

( $V_{CC} = 9.75V$ ,  $V_{EE} = -4.75V$ ,  $V_{DD} = 3.3V$ ,  $V_{HHP} = 17.5V$ ,  $V_{DHV\_} = 3V$ ,  $V_{DLV\_} = 0V$ ,  $V_{DTV\_} = 1.5V$ ,  $SC1 = SC0 = 0$ ,  $V_{CPHV\_} = 7.2V$ ,  $V_{CPLV\_} = -2.2V$ ,  $R_T = 50\Omega \parallel 1pF$ ,  $C_L = 100pF$ ,  $CTV\_ = 1.4V$ ,  $T_J = +70^\circ C$ , unless otherwise specified. All temperature coefficients are measured at  $T_J = +40^\circ C$  to  $+100^\circ C$ .)

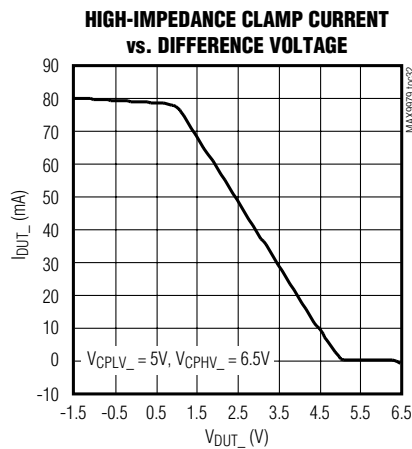
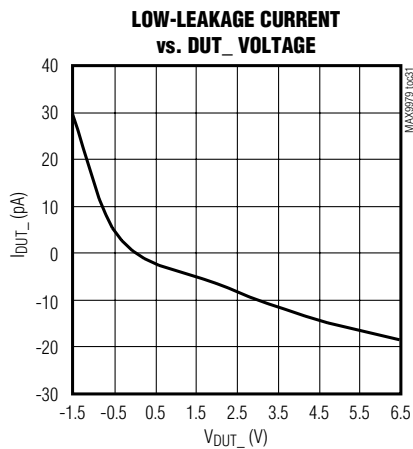
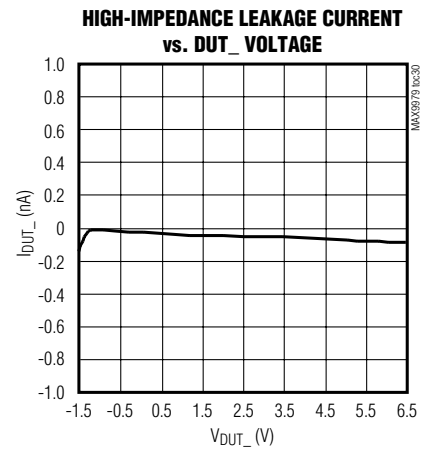
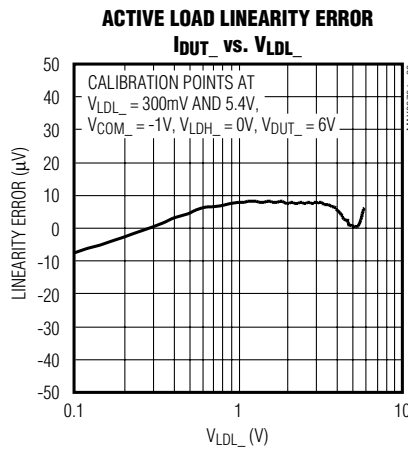
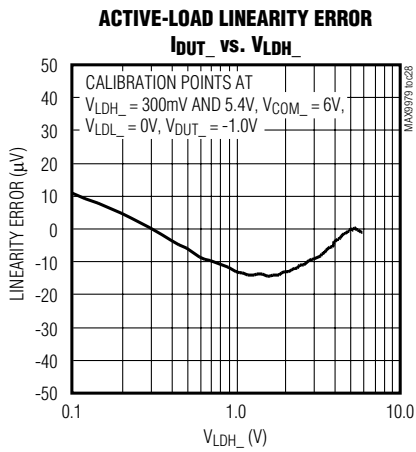
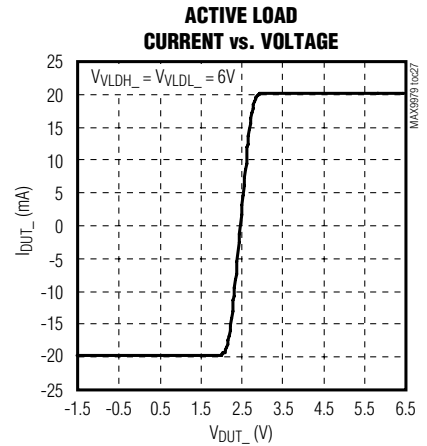
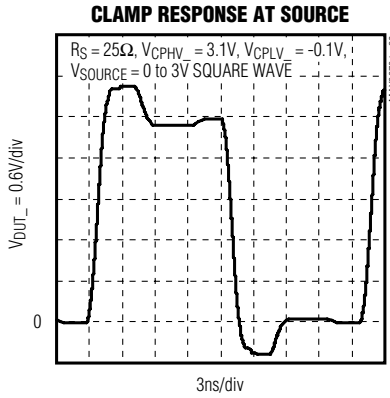
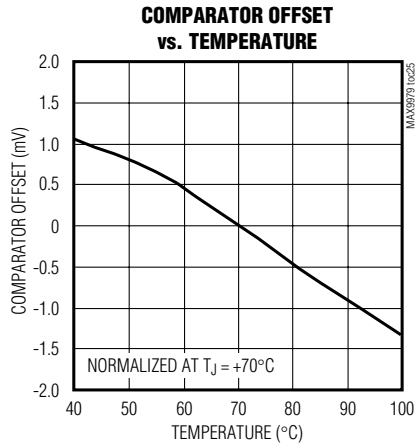

# Dual 1.1Gbps Pin Electronics with Integrated PMU and Level-Setting DACs

## Typical Operating Characteristics (continued)

( $V_{CC} = 9.75V$ ,  $V_{EE} = -4.75V$ ,  $V_{DD} = 3.3V$ ,  $V_{HHP} = 17.5V$ ,  $V_{DHV\_} = 3V$ ,  $V_{DLV\_} = 0V$ ,  $V_{DTV\_} = 1.5V$ ,  $SC1 = SC0 = 0$ ,  $V_{CPHV\_} = 7.2V$ ,  $V_{CPLV\_} = -2.2V$ ,  $R_T = 50\Omega \parallel 1pF$ ,  $C_L = 100pF$ ,  $CTV\_ = 1.4V$ ,  $T_J = +70^\circ C$ , unless otherwise specified. All temperature coefficients are measured at  $T_J = +40^\circ C$  to  $+100^\circ C$ .)

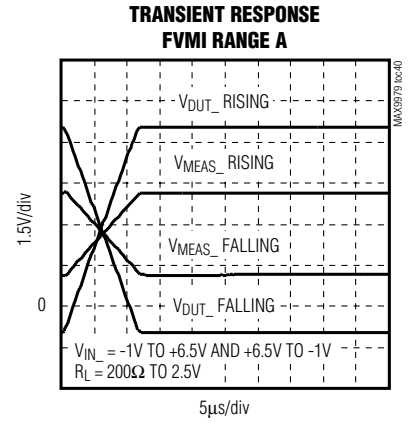
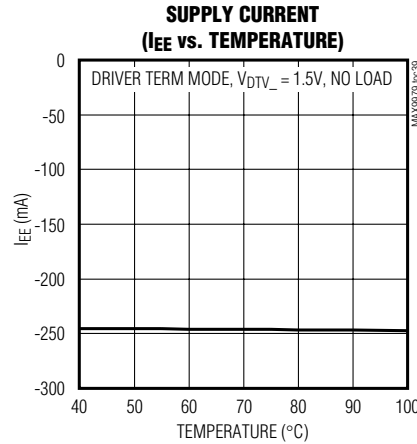
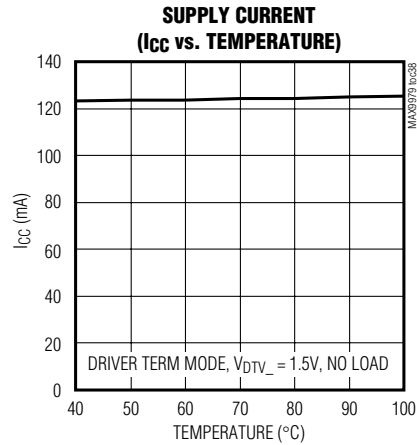
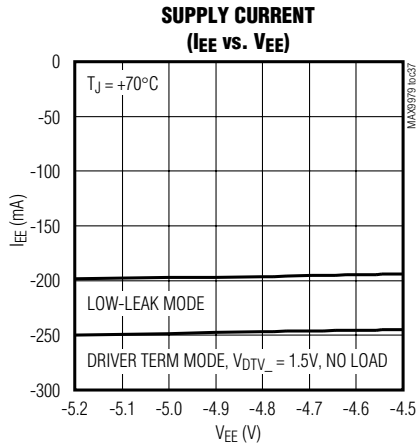
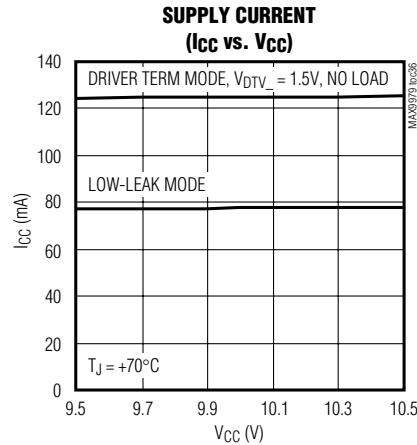
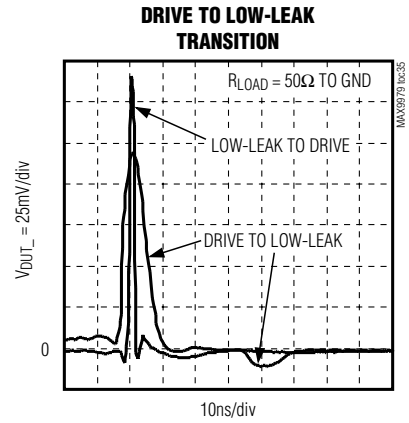
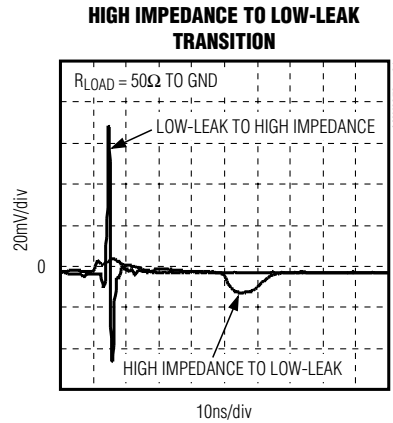
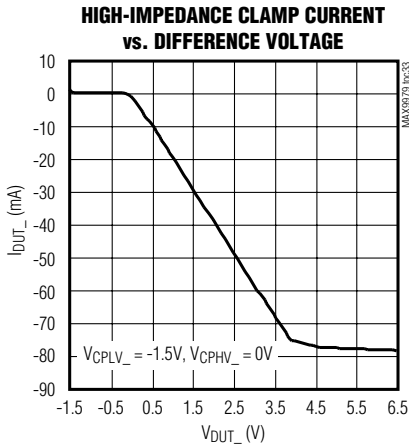

# Dual 1.1Gbps Pin Electronics with Integrated PMU and Level-Setting DACs

MAX9979

## Typical Operating Characteristics (continued)

( $V_{CC} = 9.75V$ ,  $V_{EE} = -4.75V$ ,  $V_{DD} = 3.3V$ ,  $V_{HHP} = 17.5V$ ,  $V_{DHV\_} = 3V$ ,  $V_{DLV\_} = 0V$ ,  $V_{DTV\_} = 1.5V$ ,  $SC1 = SC0 = 0$ ,  $V_{CPHV\_} = 7.2V$ ,  $V_{CPLV\_} = -2.2V$ ,  $R_T = 50\Omega \parallel 1pF$ ,  $C_L = 100pF$ ,  $CTV\_ = 1.4V$ ,  $T_J = +70^\circ C$ , unless otherwise specified. All temperature coefficients are measured at  $T_J = +40^\circ C$  to  $+100^\circ C$ .)

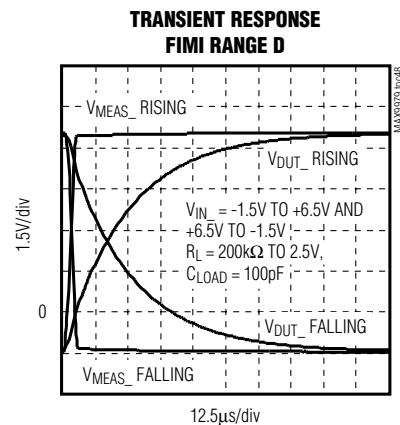
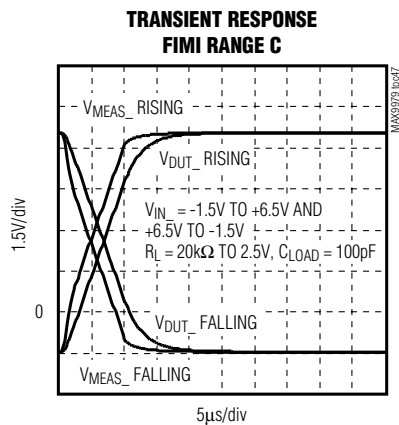
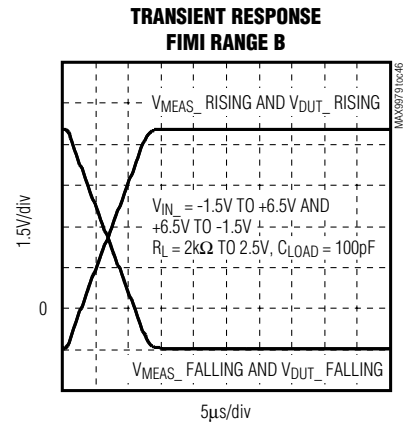
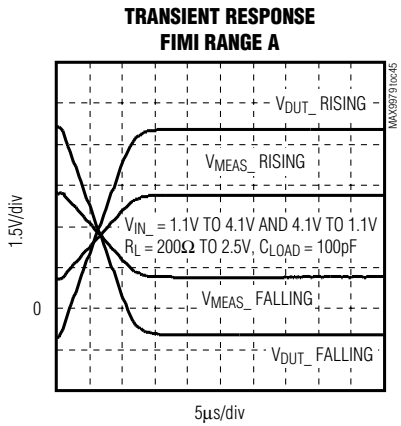
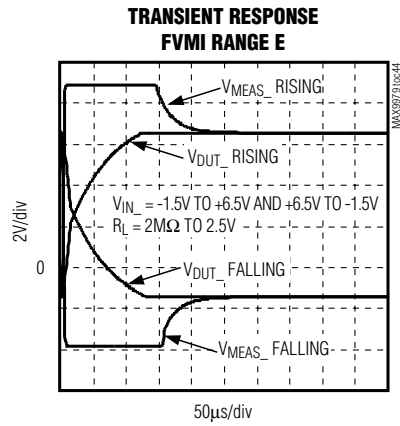
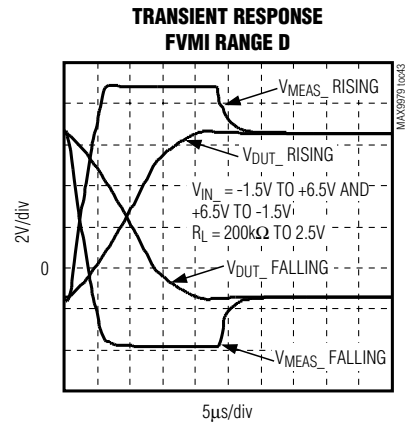
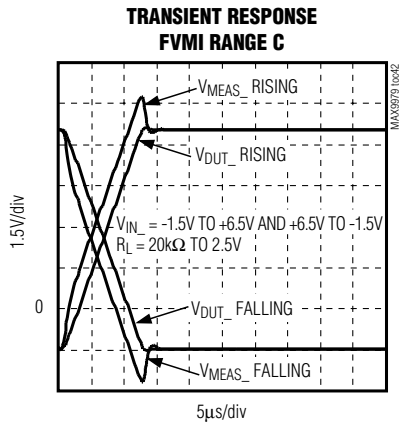
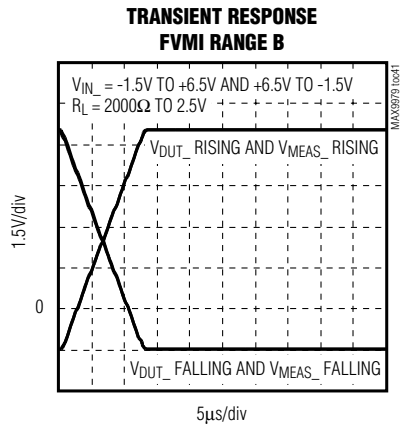

# Dual 1.1Gbps Pin Electronics with Integrated PMU and Level-Setting DACs

## Typical Operating Characteristics (continued)

( $V_{CC} = 9.75V$ ,  $V_{EE} = -4.75V$ ,  $V_{DD} = 3.3V$ ,  $V_{HHP} = 17.5V$ ,  $V_{DHV\_} = 3V$ ,  $V_{DLV\_} = 0V$ ,  $V_{DTV\_} = 1.5V$ ,  $SC1 = SC0 = 0$ ,  $V_{CPHV\_} = 7.2V$ ,  $V_{CPLV\_} = -2.2V$ ,  $R_T = 50\Omega \parallel 1pF$ ,  $C_L = 100pF$ ,  $CTV\_ = 1.4V$ ,  $T_J = +70^\circ C$ , unless otherwise specified. All temperature coefficients are measured at  $T_J = +40^\circ C$  to  $+100^\circ C$ .)

**TRANSIENT RESPONSE  
FIMI RANGE E**

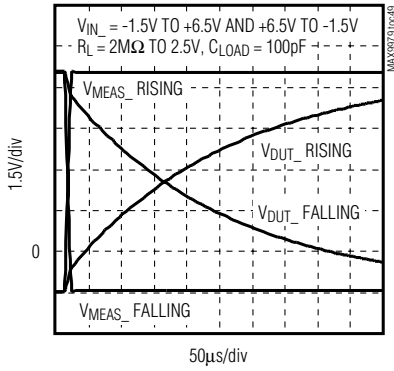

**TRANSIENT RESPONSE  
FIMV RANGE C**

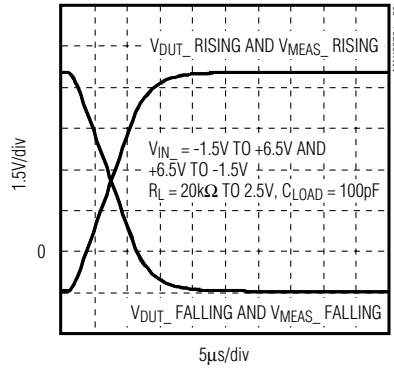

**TRANSIENT RESPONSE  
VHH**

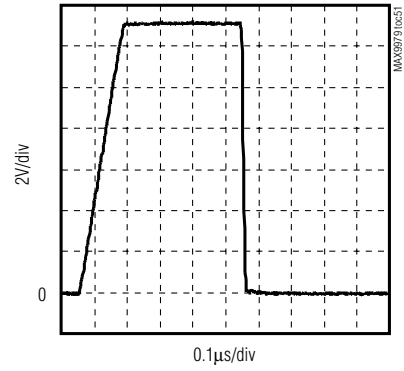

**DRIVER  
CABLE-DROOP COMPENSATION**

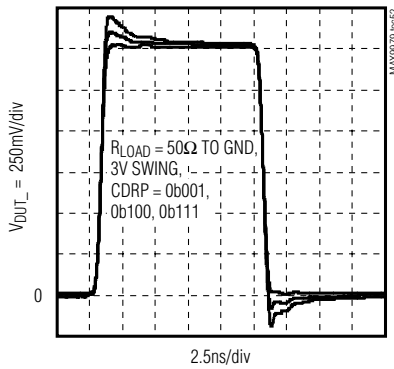

**DRIVER  
1.2Gbps TOGGLE RATE, 1V**

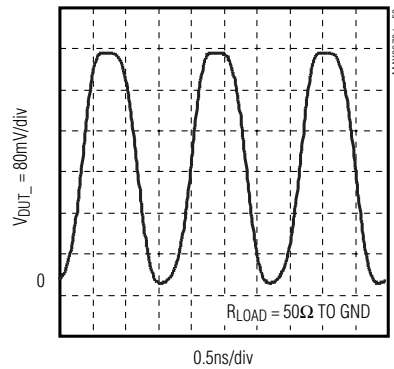

**DRIVER  
900Mbps TOGGLE RATE, 3V**

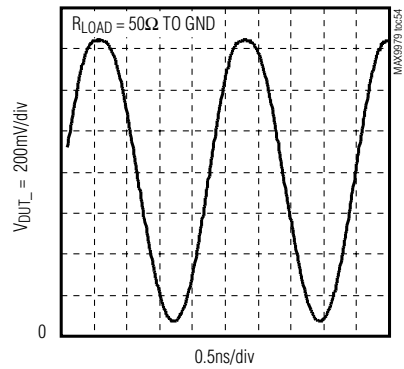

**PMU  
RANGE CHANGE A TO B**

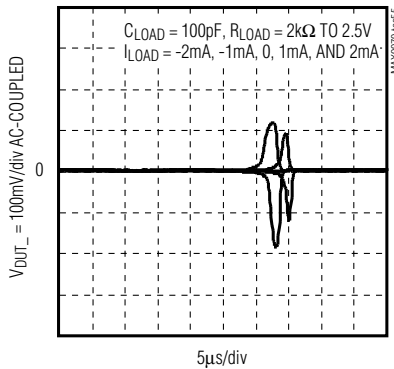

**PMU  
RANGE CHANGE B TO A**

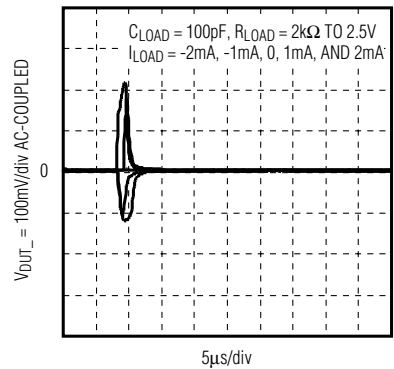

# Dual 1.1Gbps Pin Electronics with Integrated PMU and Level-Setting DACs

MAX9979

## Typical Operating Characteristics (continued)

( $V_{CC} = 9.75V$ ,  $V_{EE} = -4.75V$ ,  $V_{DD} = 3.3V$ ,  $V_{HHP} = 17.5V$ ,  $V_{DHV\_} = 3V$ ,  $V_{DLV\_} = 0V$ ,  $V_{DTV\_} = 1.5V$ ,  $SC1 = SC0 = 0$ ,  $V_{CPHV\_} = 7.2V$ ,  $V_{CPLV\_} = -2.2V$ ,  $R_T = 50\Omega$  ||  $1pF$ ,  $C_L = 100pF$ ,  $CTV\_ = 1.4V$ ,  $T_J = +70^\circ C$ , unless otherwise specified. All temperature coefficients are measured at  $T_J = +40^\circ C$  to  $+100^\circ C$ .)

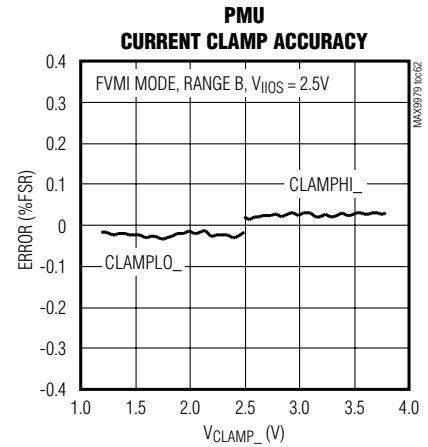
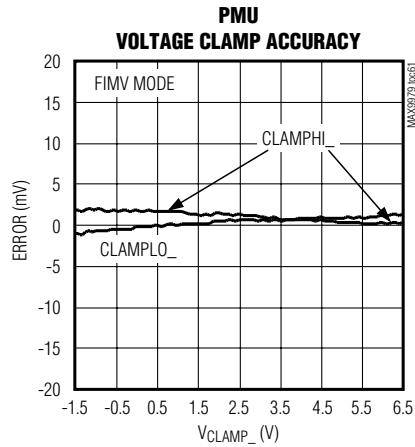
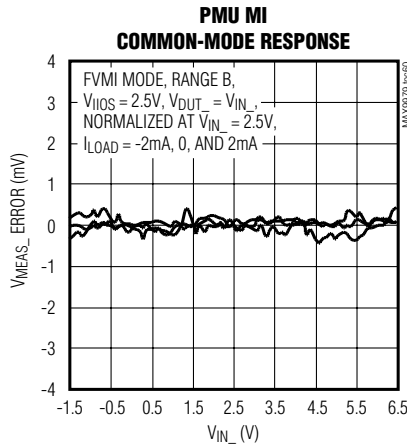
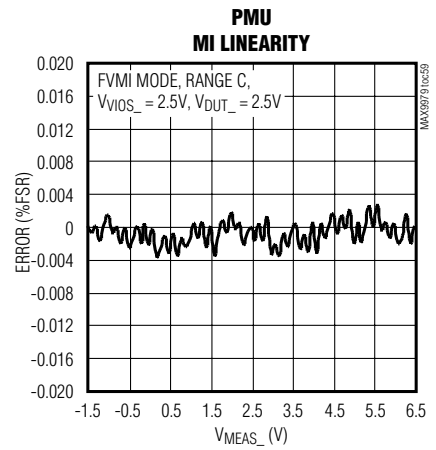
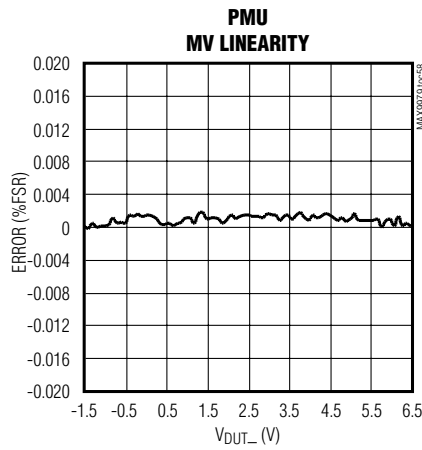
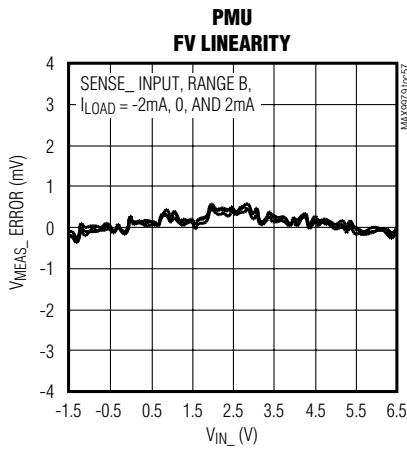

# Dual 1.1Gbps Pin Electronics with Integrated PMU and Level-Setting DACs

## Pin Description

PIN	NAME	DESCRIPTION
1	MEAS0	Channel 0 Measure Output
2	DUTHI0	Channel 0 PMU High Comparator Output
3	DUTLO0	Channel 0 PMU Low Comparator Output
4	REF	DAC Reference Input
5	DGS	DUT Ground Sense Input
6, 35, 51	GND	Analog Ground
7	DOUT	Data Output. Serial-interface data output.
8	DGND	Digital Ground
9	$\overline{\text{CS}}$	Chip-Select Input
10	SCLK	Serial-Clock Input
11	DIN	Data Input. Serial-interface data input.
12	V <sub>DD</sub>	Digital Power Supply
13	$\overline{\text{LOAD}}$	Load Input. Serial-interface asynchronous load control.
14	$\overline{\text{RST}}$	Reset Input. Serial-interface reset.
15	DUTLO1	Channel 1 PMU Low Comparator Output
16	DUTHI1	Channel 1 PMU High Comparator Output
17	MEAS1	Channel 1 Measure Output
18, 37, 40, 46, 49, 68	V <sub>CC</sub>	Positive Power Supply
19, 36, 39, 47, 50, 67	V <sub>EE</sub>	Negative Power Supply
20	$\overline{\text{HIZMEASP1}}$	Channel 1 High-Impedance Enable Input for PMU Measure Output
21	$\overline{\text{LLEAKP1}}$	Channel 1 Low-Leak Enable Input
22	NRCV1	Channel 1 Negative Receive Multiplexer Control Input
23	RCV1	Channel 1 Positive Receive Multiplexer Control Input
24	BV1	Channel 1 Bias Voltage Input
25	NDATA1	Channel 1 Negative Data Multiplexer Control Input
26	DATA1	Channel 1 Positive Data Multiplexer Control Input
27	$\overline{\text{ENVHHP1}}$	Channel 1 High-Voltage Mode Enable Input
28	NCL1	Channel 1 Negative Low Comparator Output
29	CL1	Channel 1 Positive Low Comparator Output
30	CTV1	Channel 1 Comparator Termination Voltage
31	NCH1	Channel 1 Negative High Comparator Output
32	CH1	Channel 1 Positive High Comparator Output
33	SENSE1	Channel 1 PMU Sense Input
34, 42, 52	N.C.	No Connection. Not internally connected.
38	DUT1	Channel 1 DUT Connection



# Dual 1.1Gbps Pin Electronics with Integrated PMU and Level-Setting DACs

MAX9979

## Pin Description (continued)

PIN	NAME	DESCRIPTION
41	TEMP	Temperature Output
43	V <sub>HHP</sub>	High-Voltage Power Supply
44	PMU-F	PMU External Force Connection
45	PMU-S	PMU External Sense Connection
48	DUT <sub>0</sub>	Channel 0 DUT Connection
53	SENSE <sub>0</sub>	Channel 0 PMU Sense Input
54	CH <sub>0</sub>	Channel 0 Positive High Comparator Output
55	NCH <sub>0</sub>	Channel 0 Negative High Comparator Output
56	CTV <sub>0</sub>	Channel 0 Comparator Termination Voltage
57	CL <sub>0</sub>	Channel 0 Positive Low Comparator Output
58	NCL <sub>0</sub>	Channel 0 Negative Low Comparator Output
59	$\overline{\text{ENVHHP}}_0$	Channel 0 High-Voltage Mode Enable Input
60	DATA <sub>0</sub>	Channel 0 Positive Data Multiplexer Control Input
61	N <sub>DATA</sub> <sub>0</sub>	Channel 0 Negative Data Multiplexer Control Input
62	BV <sub>0</sub>	Channel 0 Bias Voltage Input
63	RCV <sub>0</sub>	Channel 0 Positive Receive Multiplexer Control Input
64	N <sub>RCV</sub> <sub>0</sub>	Channel 0 Negative Receive Multiplexer Control Input
65	$\overline{\text{LLEAKP}}_0$	Channel 0 Low-Leak Enable Input
66	$\overline{\text{HIZMEASP}}_0$	Channel 0 High-Impedance Enable Input For PMU Measure Output
—	EP	Exposed Pad. Internally connected to ground. Connect to a large open copper PCB plane or heatsink to maximize thermal performance. Not intended as an electrical connection point.

## Detailed Description

The MAX9979 dual-channel pin electronics DCL/PMU integrates multiple pin-electronics functions into a single IC. Each channel includes a four-level pin driver, a window comparator, a differential comparator, dynamic clamps, a versatile PMU, an active load, and 14 independent 16-bit level-setting DACs. Additionally, each channel of the MAX9979 features programmable cable-droop compensation for the driver output and for the comparator input, adjustable driver output resistance, and driver slew-rate adjustment.

The MAX9979 driver features a wide -1.5V to +6.5V high-speed operating range, high-impedance and active-termination (3rd-level drive) modes, and is highly linear even at low voltage swings. The MAX9979 also features a built-in super voltage (V<sub>HHP</sub>) level up to 13V. The driver provides high-speed differential control inputs compatible with most high-speed logic families. The window

comparators provide extremely low timing variation over changes in slew rate, pulse width, or overdrive voltage, and have 50Ω source outputs internally terminated to an applied voltage at CTV<sub>-</sub>. When high-impedance mode is selected, the programmable dynamic clamps provide damping of high-speed DUT waveforms. The 20mA active load facilitates fast contact testing when used in conjunction with the comparators, and functions as a pullup for open-drain/collector DUT outputs. The PMU offers five current ranges from ±2μA to ±50mA and can force and measure current or voltage. Placing the MAX9979 DUT<sub>-</sub> output into its very low-leakage state disables the DCL functions and the PMU force function. This feature is convenient for making IDDQ measurements without the need for an output disconnect relay. Low-leakage control is independent for each channel. An SPI-compatible serial interface and external inputs configure the MAX9979.

# Dual 1.1Gbps Pin Electronics with Integrated PMU and Level-Setting DACs

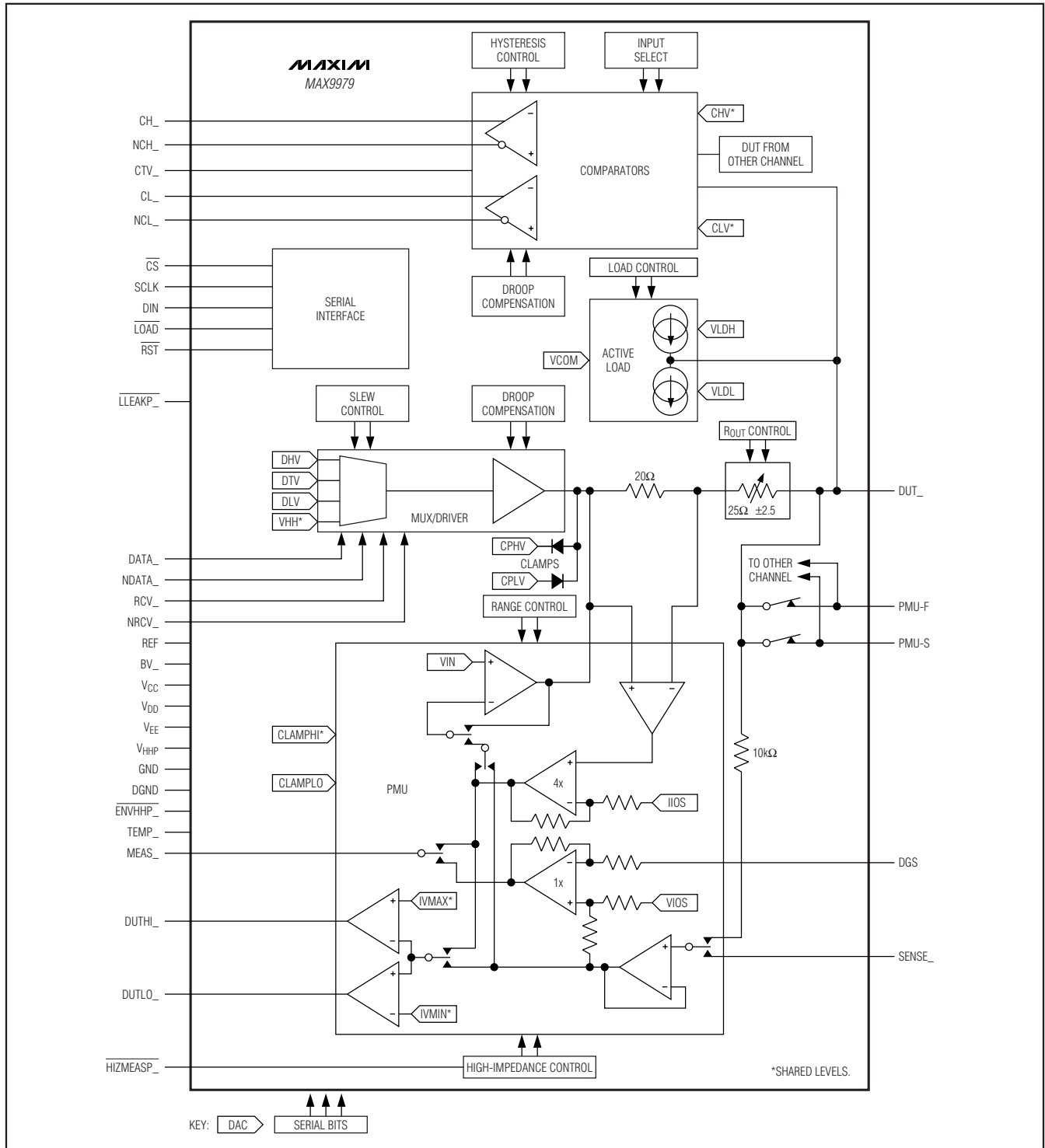

Figure 1. Simplified Block Diagram. Only one of two channels is shown. The PMU is shown in high range. The single serial interface controls both channels.

# Dual 1.1Gbps Pin Electronics with Integrated PMU and Level-Setting DACs

The integration of DCL and PMU functions in the MAX9979 requires defined states to manage the interaction of these resources. The PMU controls supersede those of the DCL, as described below and shown in Table 1. Important details to keep in mind are:

- Normal high-speed DCL operation is intended only when the PMU is in the FNMN state and the DCL is available, as indicated by Note B in Table 1.
- Forcing  $\overline{\text{LLEAKP}} = 0$  immediately places the DCL into low-leak mode, and the PMU into its high-impedance state independent of any other programmed control bit or external control inputs. Forcing  $\overline{\text{LLEAKP}} = 1$  is required to allow any other mode of operation.
- Forcing  $\overline{\text{HIZFORCE}} = 1$  enables the PMU and simultaneously forces the DCL into low-leak mode.
- Additional PMU settings such as the force and measure modes, current range, the measure output, comparators, and the clamp features are controlled as described later in this document.
- The MAX9979 provides calibration modes under which both the DCL and the PMU are simultaneously active. Forcing  $\overline{\text{HIZFORCE}} = 0$  ordinarily disables the PMU, however, when  $\overline{\text{LLEAKS}}$  is not asserted, the  $\text{FMODE}_$  and  $\text{MMODE}_$  bits select these calibra-

tion modes. While in a calibration mode, the DCL states are still selected by the controls normally associated with those functions. When in a calibration mode, the PMU range A is not available. The PMU range defaults to range B if the serial-interface bit  $\text{RS2}_ = 1$ .

## Driver

The driver uses a high-speed multiplexer to select one of three DAC voltages ( $\text{DHV}_$ ,  $\text{DLV}_$ , and  $\text{DTV}_$ ), or to select high-impedance mode. Multiplexer switching is controlled by high-speed differential inputs  $\text{DATA}_/\text{NDATA}_$  and  $\text{RCV}_/\text{NRCV}_$  and mode-control bit  $\text{TMSEL}_$  (see Table 2). The multiplexer output is buffered to drive  $\text{DUT}_$ . A programmable slew-rate circuit controls the slew rate of the buffer input.

In high-impedance mode, the clamps and comparators remain connected to  $\text{DUT}_$ , the  $\text{DUT}_$  bias current is less than  $\pm 2\mu\text{A}$ , and the node continues to track high-speed signals. In low-leakage mode, the bias current at  $\text{DUT}_$  is further reduced to less than  $\pm 10\text{nA}$ , yet signal tracking slows.

The nominal driver output resistance is  $50\Omega$  and features an adjustment range of  $\pm 2.5\Omega$  through the serial interface in  $360\text{m}\Omega$  increments. Contact the factory for different output resistance values.

**Table 1. MAX9979 Mode Selection**

MODES	DRIVER	COMPARATOR	LOAD	PMU	$\text{FMODE}_$	$\text{MMODE}_$	$\overline{\text{LLEAKP}}_$	$\overline{\text{HIZFORCE}}_$	NOTE
PMU	Low leak	Low leak	Low leak	FVMI	0	0	1	1	—
	Low leak	Low leak	Low leak	FVMV	0	1	1	1	—
	Low leak	Low leak	Low leak	FIMI	1	0	1	1	—
	Low leak	Low leak	Low leak	FIMV	1	1	1	1	—
DCL	Low leak	Available	Available	FVMI	0	0	1	0	A
	Available	Available	Available	FIMV	0	1	1	0	A
	Available	Available	Available	FNMN	1	0	1	0	B
	Available	Available	Available	FNMV	1	1	1	0	A
FNMx	Low leak	Low leak	Low leak	FNMN	X	0	0	X	—
	Low leak	Low leak	Low leak	FNMV	X	1	0	X	—

A = Calibration modes.

B = Normal high-speed DCL operation mode.

# Dual 1.1Gbps Pin Electronics with Integrated PMU and Level-Setting DACs

Table 2. Driver Control

SERIAL-INTERFACE BITS			DIGITAL INPUTS				DRIVER OUTPUT
LLEAKS_	ENVHHS_	TMSEL_	LLEAKP_	ENVHHP_	RCV_	DATA_	
0	X*	X	1	1	0	0	Drive to DLV
0	X*	X	1	1	0	1	Drive to DHV
0	0	0	1	1	1	X	High-impedance receive
0	0	1	1	1	1	X	Drive to DTV
0	1	X	1	X	1	X	Drive to VHH**
0	0	X	1	0	X	X	Drive to VHH**
X	X	X	0	X	X	X	Low leak
1	X	X	X	X	X	X	Low leak

\*Specified DHV, DLV transition times are not altered by the state of ENVHHS\_.

\*\*PMU and active load must be disabled to drive to VHH\_ ( $\overline{HIZFORCE_} = 0$ ,  $FMODE_ = 1$ ,  $MMODE_ = 0$ ,  $LDDIS_ = 1$ ).

Table 3. Driver Slew Control

SC1_	SC0_	DRIVER SLEW RATE (%)
0	0	100*
0	1	75
1	0	50
1	1	25

\*The power-on-reset and RST default value.

### Driver Slew Control

A slew-rate circuit controls the slew rate of the buffer input. Select one of four possible slew rates according to Table 3. The speed of the internal multiplexer sets the 100% driver slew rate (see the *Driver Large-Signal Response* graph in the *Typical Operating Characteristics* section). SC1 and SC0 are set to 0 at power-up or when  $\overline{RST}$  is forced low.

### VHH Function

VHH allows DUT\_ to drive voltages up to 13V. The VHH\_ DAC, which doubles as the PMU's CLAMPHI\_ DAC, adjusts from 0 to +13V. Table 2 indicates the control settings required to set DUT\_ to VHH\_. Table 23 shows the transfer function for the VHH\_ DAC.

### Driver Cable-Droop Compensation

The driver incorporates active cable-droop compensation. At high frequencies, transmission-line effects from the DUT\_ output, across the tester signal delivery path to the device under test, can degrade the output waveform fidelity, resulting in a highly degraded or unusable signal. The compensation circuit counters this degradation by adding a double time-constant decaying wave-

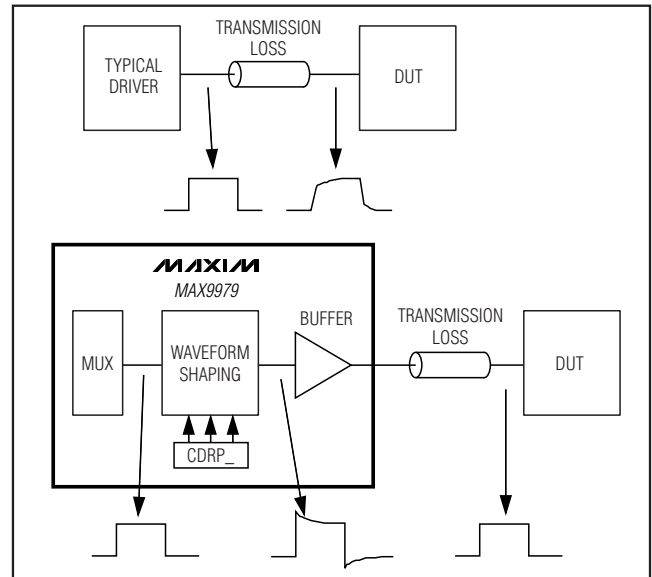

Figure 2. Cable-Droop Compensation

form to the nominal output waveform (pre-emphasis). Figure 2 depicts a comparison between a typical driver and the MAX9979, and shows how droop compensation counters signal degradation. Control bits CDRP0, CDRP1, and CDRP2 vary the amplitude of the compensation signal. Table 4 shows the percent compensation as a function of control bit settings. The power-on-reset and RST values for CDRP0, CDRP1, and CDRP2 are 0. The specified default value is CDRP0 = 1 for *Electrical Characteristics* table data.

# Dual 1.1Gbps Pin Electronics with Integrated PMU and Level-Setting DACs

**Table 4. Cable-Droop Compensation Control**

SERIAL-INTERFACE BITS			DROOP COMPENSATION (%)
CDRP2_	CDRP1_	CDRP0_	
0	0	0	0*
0	0	1	1.5**
0	1	0	3
0	1	1	4.5
1	0	0	6
1	0	1	7.5
1	1	0	9
1	1	1	10.5

\*The power-on-reset and  $\overline{RST}$  default value.

\*\*Specified default value for Electrical Characteristics table data.

### Adjustable Driver Output Impedance ( $\Delta R_O$ )

The MAX9979's nominal 50 $\Omega$  driver output resistance is adjustable by  $\pm 2.5\Omega$  with a 360m $\Omega$  resolution. The RO bits in the DCL calibration register set the resistance

value. Table 5 presents the output resistance control logic. The output resistance is set to  $R_O + 0.0\Omega$  (0b1000) at power-up or when  $\overline{RST}$  is forced low.

**Table 5. Output Resistance Control**

SERIAL-INTERFACE BITS				DRIVER OUTPUT RESISTANCE ( $\Omega$ )
RO3_	RO2_	RO1_	RO0_	
0	0	0	0	$R_O - 2.88$
0	0	0	1	$R_O - 2.52$
0	0	1	0	$R_O - 2.16$
0	0	1	1	$R_O - 1.80$
0	1	0	0	$R_O - 1.44$
0	1	0	1	$R_O - 1.08$
0	1	1	0	$R_O - 0.72$
0	1	1	1	$R_O - 0.36$
1	0	0	0	$R_O + 0^*$
1	0	0	1	$R_O + 0.36$
1	0	1	0	$R_O + 0.72$
1	0	1	1	$R_O + 1.08$
1	1	0	0	$R_O + 1.44$
1	1	0	1	$R_O + 1.80$
1	1	1	0	$R_O + 2.16$
1	1	1	1	$R_O + 2.52$

\*Power-on-reset and  $\overline{RST}$  default value.

# Dual 1.1Gbps Pin Electronics with Integrated PMU and Level-Setting DACs

## Driver DATA Invert Mode

The DATA\_/NDATA\_ signals for a driver channel are internally inverted when the INVERT\_ bit in the DCL register is asserted. The INVERT\_ bit is set to 0 at power-up or when RST is forced low.

## Driver Differential Data Mode

The MAX9979 allows the drivers to be configured for control of both channels from the channel 0 DATA0/NDATA0 inputs. This feature allows the two channels to drive DUT nodes in parallel, providing a 25Ω driver at twice the nominal drive current. Enable this feature by setting the DIFFERENTIAL0 bit in the DCL register. The DIFFERENTIAL0 bit is set to 0 at power-up or when RST is forced low.

## Driver Invert + Differential Data Mode

Combining the differential and the invert modes allows the two channels to produce complementary outputs at DUT0 and DUT1 from a single digital data stream at DATA0/NDATA0. The driver block diagram (Figure 3) shows the logic of the differential and inverted modes.

## Bias Voltage Input (BV\_)

Apply a voltage to BV\_ that is  $\geq$  the  $V_{IH}$  voltage used for the DATA\_ and RCV\_ inputs ( $V_{IH}$  (DATA\_, RCV\_)  $<$   $V_{BV}$   $<$  3.5V, because there are ESD-protection diodes between BV\_ and the high-speed inputs. Failure to do this turns on the protection diodes, degrading the DATA\_ and RCV\_ signals. Input bias current for BV\_ is less than 1μA.

## Driver Voltage Clamps

The voltage clamps (high and low) limit the voltage at DUT\_ and suppress reflections when the channel is configured as a high-impedance receiver. The clamps behave as diodes connected to the outputs of high-current buffers (Figure 1). Internal circuitry compensates for the diode drop at 1mA clamp current. Set the clamp voltages using the level-setting DACs (CPHV\_ and CPLV\_). The clamps are enabled only when the driver is in the high-impedance mode. For transient suppression, set the clamp voltages to approximately the minimum and maximum expected DUT\_ voltage range. The optimal clamp voltages are application-specific and must be empirically determined. Set the clamp

voltages at least 0.7V outside the expected DUT\_ voltage range when not using the clamps. Overvoltage protection then remains active without loading DUT\_. Driver clamps are always and only enabled in driver high-impedance mode.

## High-Speed Comparators

The MAX9979 provides two independent high-speed comparators for each channel. Each comparator has one input connected internally to DUT\_ and the other input connected to either CHV\_ or CLV\_ (Figure 4). Cable-droop compensation is present on both channels. Comparator outputs are a logical result of the input conditions.

This configuration switches a 16mA current source between the two outputs, and each output has an internal termination resistor connected to CTV\_. These resistors are typically 50Ω. Use alternate configurations to terminate different path impedance provided that the absolute maximum ratings are not exceeded. Note that the resistor value also sets the voltage swing. The output provides a nominal 400mV<sub>p-p</sub> swing with a 50Ω load termination, and a 50Ω source termination. See the *Electrical Characteristics* section titled *High-Speed Comparators, Logic Outputs* for definition of the  $V_{OH}$  voltage.

## Single-Ended Window Comparator

Set the DIFFERENTIAL1 bit = 0 in the channel 1 DCL register to enable the high-speed window comparator. DAC voltages CHV\_ and CLV\_ control the comparator thresholds. Table 6 shows the truth table for the comparators. Figure 4 shows the comparator block diagram.

**Table 6. Single-Ended Window Comparator Truth Table**

CONDITION		CH_	CL_
$V_{DUT\_} < V_{CHV\_}$	$V_{DUT\_} < V_{CLV\_}$	0	0
$V_{DUT\_} < V_{CHV\_}$	$V_{DUT\_} > V_{CLV\_}$	0	1
$V_{DUT\_} > V_{CHV\_}$	$V_{DUT\_} < V_{CLV\_}$	1	0
$V_{DUT\_} > V_{CHV\_}$	$V_{DUT\_} > V_{CLV\_}$	1	1

# Dual 1.1Gbps Pin Electronics with Integrated PMU and Level-Setting DACs

MAX9979

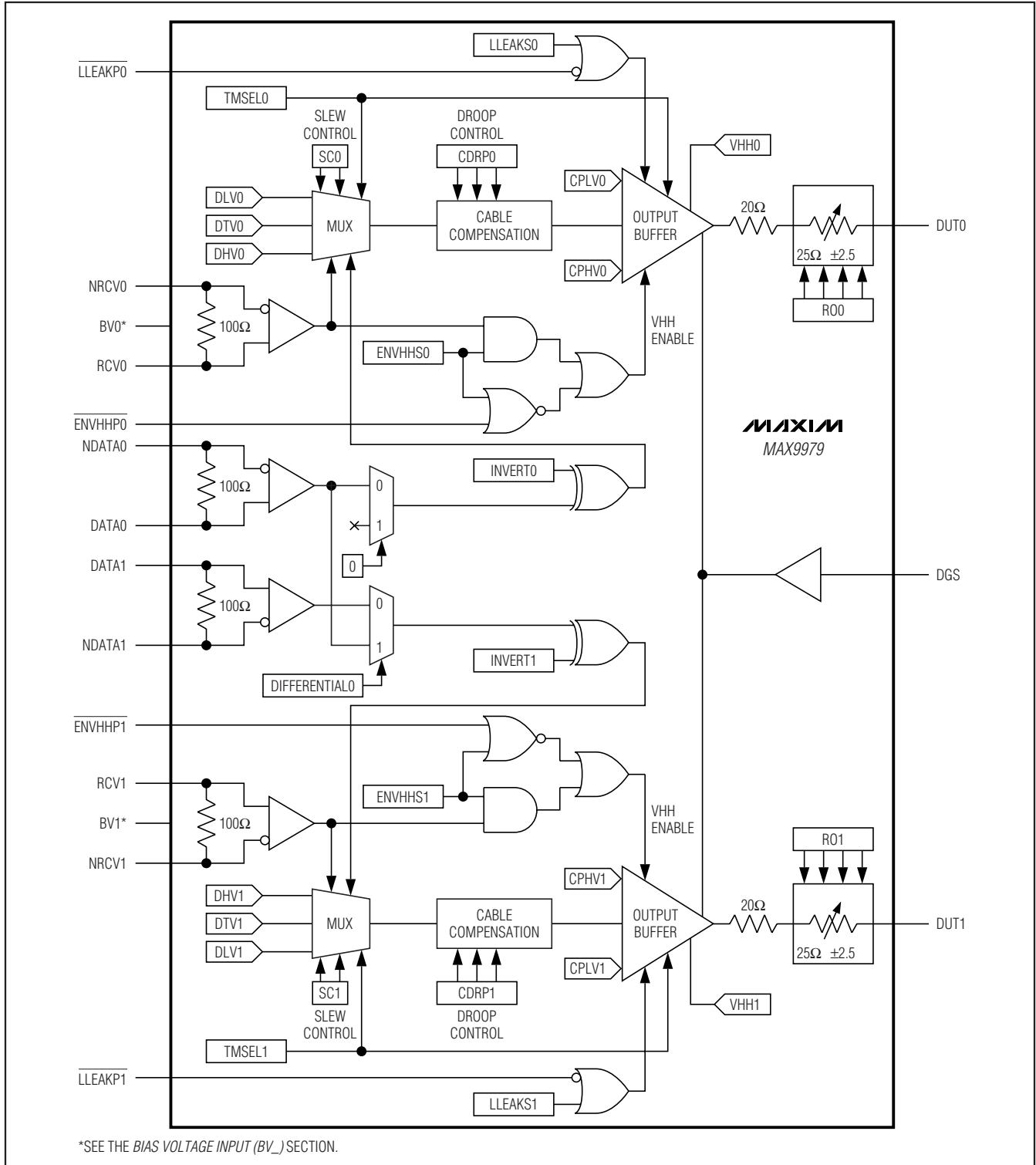

Figure 3. Driver Block Diagram

# Dual 1.1Gbps Pin Electronics with Integrated PMU and Level-Setting DACs

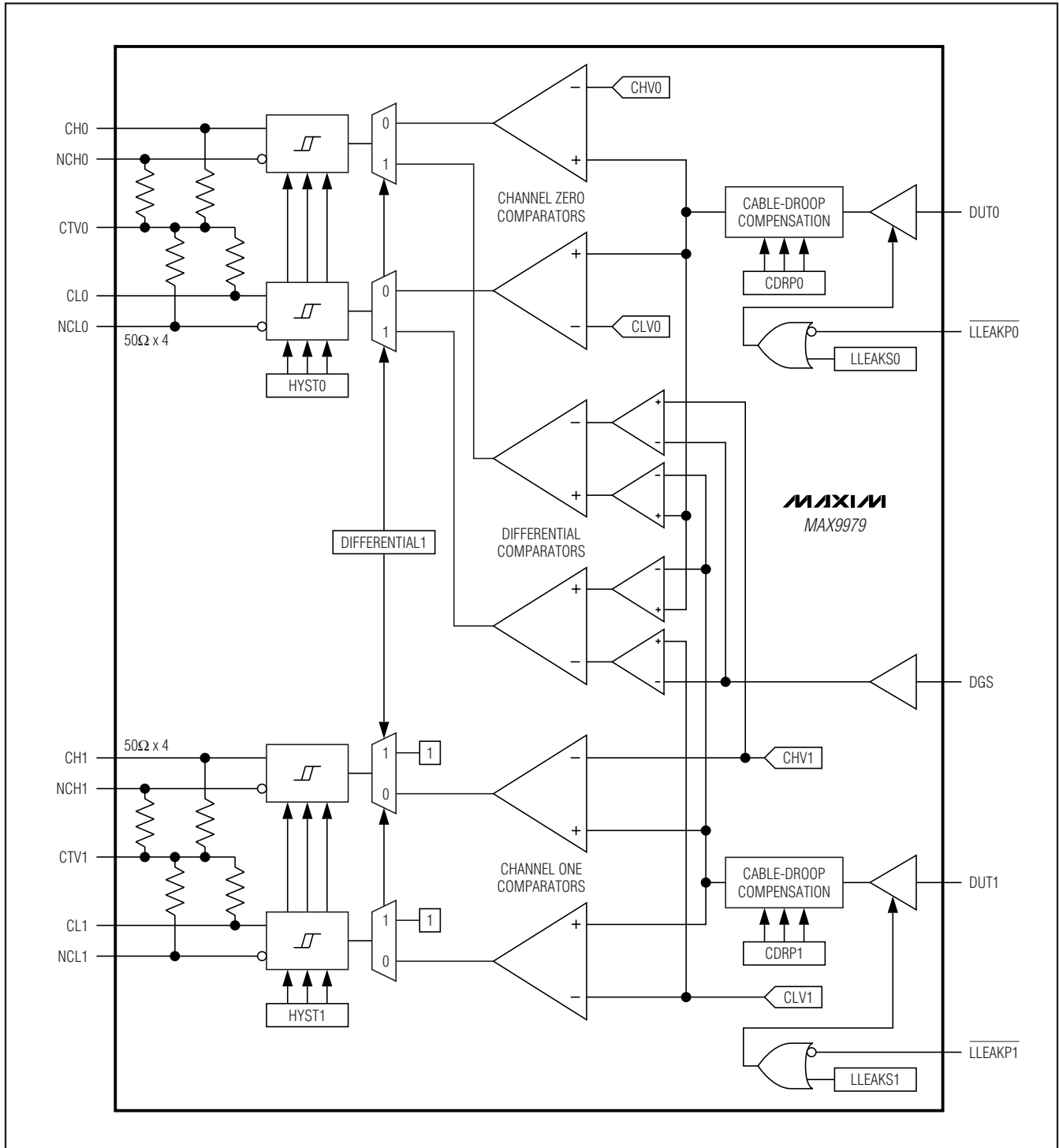

Figure 4. High-Speed Comparators Block Diagram



# Dual 1.1Gbps Pin Electronics with Integrated PMU and Level-Setting DACs

**Table 7. Differential Window Comparator Truth Table**

CONDITION		CH0	CL0
$V_{DUT0} - V_{DUT1} < V_{CHV1} - V_{DGS}$	$V_{DUT0} - V_{DUT1} < V_{CLV1} - V_{DGS}$	0	0
$V_{DUT0} - V_{DUT1} < V_{CHV1} - V_{DGS}$	$V_{DUT0} - V_{DUT1} > V_{CLV1} - V_{DGS}$	0	1
$V_{DUT0} - V_{DUT1} > V_{CHV1} - V_{DGS}$	$V_{DUT0} - V_{DUT1} < V_{CLV1} - V_{DGS}$	1	0
$V_{DUT0} - V_{DUT1} > V_{CHV1} - V_{DGS}$	$V_{DUT0} - V_{DUT1} > V_{CLV1} - V_{DGS}$	1	1

**Differential Window Comparator**

Set the DIFFERENTIAL1 bit = 1 in the channel 1 DCL register to enable the high-speed differential window comparator. CHV1 and CLV1 control the differential comparator thresholds. CHV0 and CLV0 are not used when differential comparison is active. The valid voltage range for CHV1 and CLV1 in differential comparison mode is  $\pm 1V$ . Setting levels outside  $\pm 1V$  does not damage the device, but performance is not guaranteed. Differential comparator outputs are multiplexed to the channel 0 comparator outputs. The channel 1 comparator outputs are both forced to a high state. Figure 4 shows the operation of the comparators. Table 7 shows the truth table for the differential comparator. Figure 4 shows the comparator block diagram.

**Comparator Hysteresis**

The DCL calibration register controls the high-speed comparator hysteresis. The HYST bits of that register

select one of eight values (0, 2mV, 4mV, 6mV, 8mV, 10mV, 12mV, or 15mV). Hysteresis control affects both single-ended and differential comparators. The HYST bits are set to 0b000 at power-up or when  $\overline{RST}$  is forced low. Table 8 shows the HYST bit functions.

**Table 8. Hysteresis Logic**

SERIAL-INTERFACE BITS			COMPARATOR HYSTERESIS (mV)
HYST1 <sub>-</sub>	HYST1 <sub>-</sub>	HYST0 <sub>-</sub>	
0	0	0	0
0	0	1	2
0	1	0	4
0	1	1	6
1	0	0	8
1	0	1	10
1	1	0	12
1	1	1	15

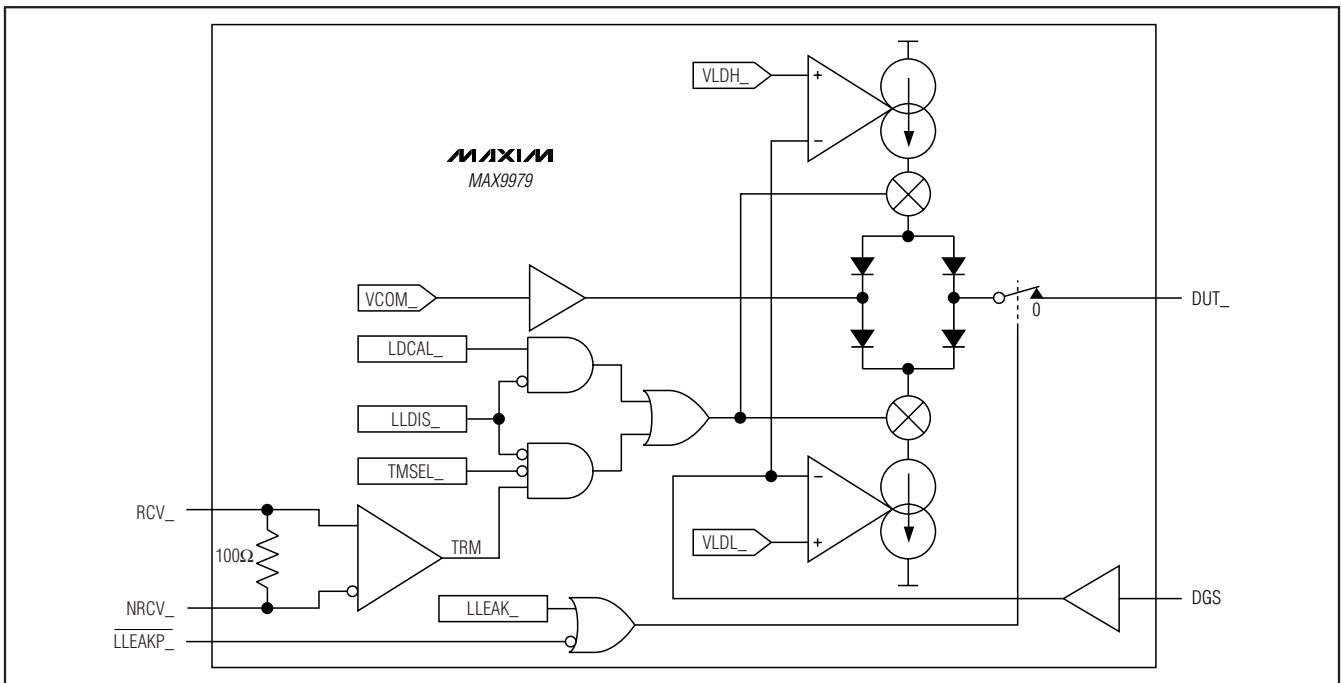

Figure 5. Active Load Block Diagram (One Channel Shown)

# Dual 1.1Gbps Pin Electronics with Integrated PMU and Level-Setting DACs

## Comparator Cable-Droop Compensation

Control comparator cable-droop compensation using the same serial bits used for the driver droop compensation, CDRP\_. Cable-droop compensation is active for both the single-ended and the differential comparators.

## Active Load

The active load is a linearly programmable current source and sink, a commutation buffer, and a diode bridge (Figure 5). Level-setting DACs VLDH\_ and VLDL\_ set the sink and source currents from 0 to 20mA. Level-setting DAC VCOM\_ sets the commutation buffer output voltage. The source and sink naming convention is referenced to the MAX9979, so current out of the MAX9979 constitutes source current and current into the MAX9979 constitutes sink current.

The programmed source current loads the device under test when  $V_{DUT\_} < V_{COM\_}$ . The programmed sink current loads the device under test when  $V_{DUT\_} > V_{COM\_}$ . The high-speed differential inputs (RCV\_/NRCV\_) and three bits of the control word (LDDIS\_, LDCAL\_, and TMSEL\_) control the load. LLEAKP\_ and LLEAK\_ place the load into low-leakage mode. The low-leakage controls override other controls. Table 9 details load control logic.

**Table 9. Load Control Logic**

RCV_	TMSEL_	LDDIS_	LDCAL_	LLEAKS_	LLEAKP_	LOAD STATE
X	X	X	X	1	X	Low leak
X	X	X	X	X	0	Low leak
0	X	0	0	0	1	Off
X	X	1	X	0	1	Off
1	1	0	0	0	1	Off
1	0	0	0	0	1	On
X	X	0	1	0	1	On

**Table 10. PMU Current-Range Control**

DIGITAL INPUT	SERIAL-INTERFACE BITS				RANGE
	LLEAKP_	HIZFORCE_	RS2_	RS1_	
X	X	0	0	0	E
X	X	0	0	1	D
X	X	0	1	0	C
X	X	0	1	1	B
X	0	1	X	X	B*
0	1	1	X	X	B*
1	1	1	X	X	A

\*Range A operation is not allowed for PMU high-impedance modes—PMU defaults to range B.

## Load Calibration Enable (LDCAL\_)

LDCAL\_ allows the load and driver to be simultaneously enabled for diagnostic purposes. LDDIS\_ overrides LDCAL\_.

## Parametric Measurement Unit (PMU)

The MAX9979 PMU forces and measures voltages from -1.5V to 6.5V, and currents up to  $\pm 50\text{mA}$ . The lowest full-scale current range is  $\pm 2\mu\text{A}$ . Available PMU modes are force-voltage/measure voltage (FVMV), force-voltage/measure current (FVMI), force-current/measure current (FIMI), force-current/measure voltage (FIMV), force-nothing/measure voltage (FNMV), and force-nothing/measure nothing (FNMN). Figure 6 presents a block diagram on the PMU.

## PMU Current-Range Selection

Three bits from the control word (RS0, RS1, and RS2) control the full-scale current range for both force-current (FI) and measure-current (MI) modes. The PMU ranges are independent of the programmed PMU mode, except range A, which is not allowed in any calibration mode. In these modes range A defaults to range B (see Table 1). Table 10 presents the PMU current-range control logic.

# Dual 1.1Gbps Pin Electronics with Integrated PMU and Level-Setting DACs

MAX9979

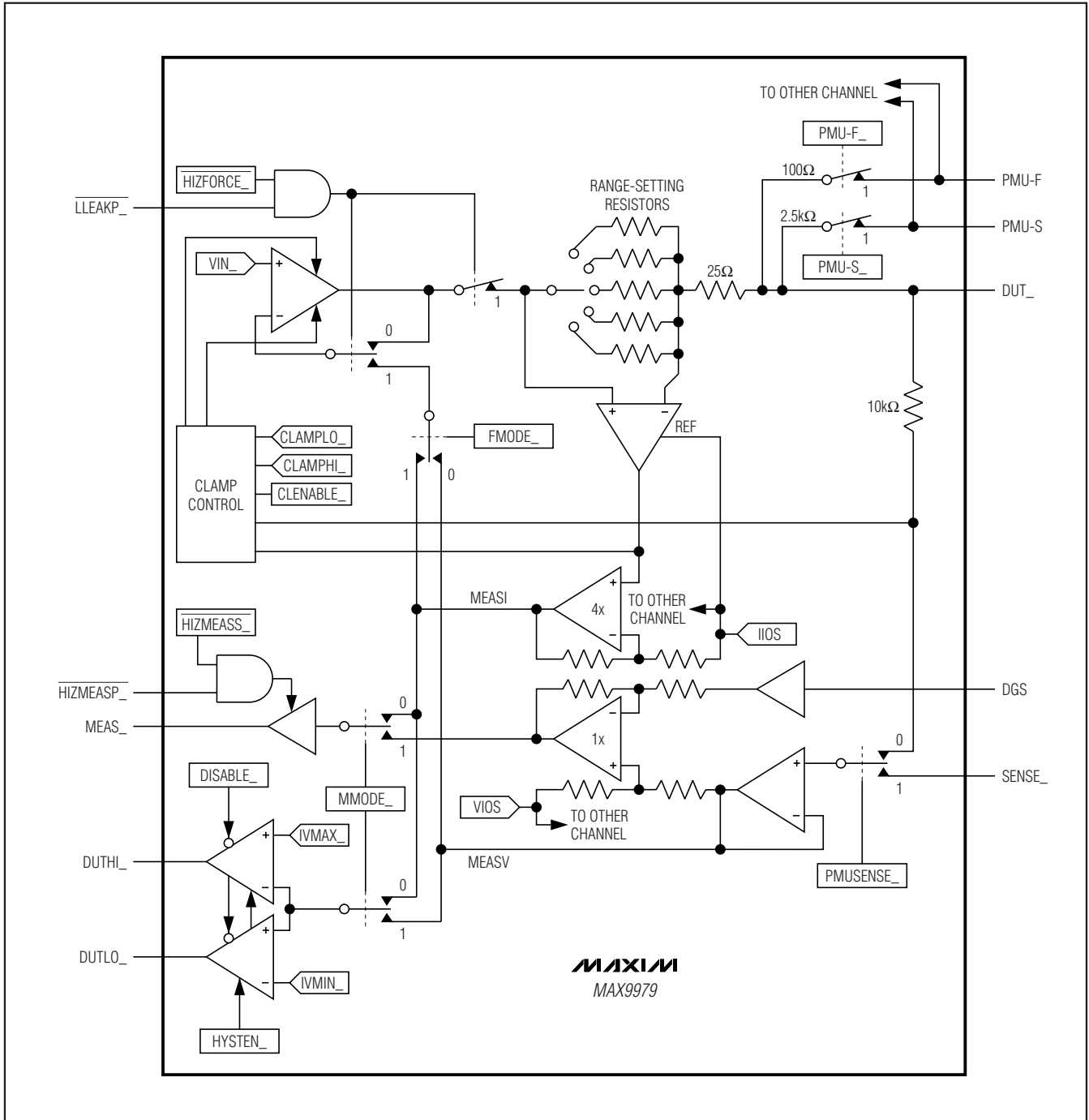

Figure 6. PMU Block Diagram (One Channel Shown)

# Dual 1.1Gbps Pin Electronics with Integrated PMU and Level-Setting DACs

## PMU Comparators

Two comparators, configured as a window comparator, monitor the MEASV\_ and MEASI\_ signals (Figure 6). Level-setting DACs IVMAX\_ and IVMIN\_ set the high and low thresholds that determine the window (DAC IVMAX\_ shares duties with VHH\_). Both PMU window comparator outputs are open-drain and share a single serial disable bit ( $\overline{\text{DISABLE\_}}$ ) that puts the outputs in a high-impedance, low-leakage state. MEAS\_ includes the influence of VIOS, while the comparator outputs do not. Table 11 presents the PMU comparator output logic.

## PMU Measure Output (MEAS\_)

The MEAS\_ output presents a voltage proportional to the measured voltage or current. Force logic input HIZMEASP\_ or bit HIZMEASS\_ low to place MEAS\_ in a low-leakage, high-impedance state.

## VIOS Offset Level for PMU Measure Voltage MEAS\_ Output

In MV mode, use the VIOS level-setting DAC to offset the MEAS\_ output voltage. The valid range of VIOS is 0 to 1.5V, but the VIOS DAC is programmable from -1.25V to +3.75V. The single VIOS DAC is shared by both channels. VIOS allows level shifting the MEAS\_ output, useful when MEAS\_ is read by a unipolar ADC. The nominal 0x0000 to 0xFFFF code range for VIOS equates to -1.25V to +3.75V. The power-on-reset and  $\overline{\text{RST}}$  state of VIOS is 0x4000, or 0V, the level for normal operation. The MEAS\_ output tracks DGS. The VIOS DAC range is programmable outside the valid operational range of the VIOS signal, but doing so will not harm the device. Table 23 presents the VIOS DAC transfer function.

## IIOS Reference Level for PMU Measure Current

### MEAS\_ Output

In MI mode, adjust the MEAS\_ output around the  $\text{IDUT}_ = 0$  center reference using the IIOS level-setting DAC. IIOS is programmable from 0 to 5V, but levels outside of the 2V to 4V range are invalid. The single IIOS DAC is shared by both channels. IIOS allows level shifting the  $\pm 4\text{V}$  MI output range to fully above ground at the MEAS\_ output, useful when MEAS\_ is read by a unipolar ADC. The nominal 0x0000 to 0xFFFF code range for IIOS equates to 0 to 5V. The power-on-reset and  $\overline{\text{RST}}$  state of IIOS is 0x4000, or 1.25V. For normal operation, the level of IIOS is 2.5V for a -1.5V to +6.5V MI MEAS\_ output. The IIOS DAC range is programmable outside the valid operational range of the IIOS signal, but doing so will not harm the device. Table 23 presents the IIOS DAC transfer function.

The MI MEAS\_ output is a buffered version of an internal node that is used to close the force-current loop. The sourcing range of forced current is limited for IIOS levels above 3.5V by the  $V_{\text{IN}}$  upper limit of approximately 7.5V.

## PMU Sense

Control bit PMUSENSE\_ determines which of two inputs reaches the PMU sense amplifier (Figure 6). One input is from DUT\_ through an internal 10k $\Omega$  resistor, the other input is from external input SENSE\_. Not shown in Figure 6 is a third input to the sense amplifier (GND), which is used in VHH and FNMN modes to isolate and protect the amplifier from potential overvoltage and glitches. GND is connected automatically based on mode setting and no discrete control is required. Table 12 presents the PMU sense control logic.

**Table 11. PMU Comparator Output Logic**

$\overline{\text{DISABLE\_}} \text{ BIT}$	CONDITION	COMPARATOR OUTPUTS	
		DUTHI_	DUTLO_
0	X	High impedance	High impedance
1	$V_{\text{MEASURE}} > V_{\text{IVMAX}}$ and $V_{\text{IVMIN}}$	0	1
1	$V_{\text{IVMAX}} > V_{\text{MEASURE}} > V_{\text{IVMIN}}$	1	1
1	$V_{\text{IVMAX}}$ and $V_{\text{IVMIN}} > V_{\text{MEASURE}}$	1	0
1	$V_{\text{IVMIN}} > V_{\text{MEASURE}} > V_{\text{IVMAX}}^*$	0	0

\*Normal operation is with  $V_{\text{IVMAX}} > V_{\text{IVMIN}}$ . This condition has  $V_{\text{IVMIN}} > V_{\text{IVMAX}}$ . This does not cause any problems with the operation of the comparators.

# Dual 1.1Gbps Pin Electronics with Integrated PMU and Level-Setting DACs

**Table 12. PMU Sense Control Logic**

DIGITAL INPUT	SERIAL-INTERFACE BITS				PMU MODE	SENSE PATH
	LLEAKP_	HIZFORCE_	FMODE_	MMODE_		
1	1	X	X	0	FyMy*	Internal
1	1	X	X	1	FyMy*	External
1	0	0	X	0	FVMy* (calibration)	Internal
1	0	0	X	1	FVMy* (calibration)	External
1	0	1	0	X	FNMN	GND
1	0	1	1	0	FNMV (calibration)	Internal
1	0	1	1	1	FNMV (calibration)	External
0	X	X	0	X	FNMN	GND
0	X	X	1	0	FNMV (calibration)	Internal
0	X	X	1	1	FNMV (calibration)	External

\*y = V or I.

### PMU Analog Signal Polarities

In FV mode, DUT\_ voltage is proportional to level-setting DAC voltage  $V_{IN\_}$ . In FI mode, the current flowing out of DUT\_ is equal to:

$$\frac{(V_{IN} - V_{IIOs})}{4 \times R_{RANGE}}$$

Positive current is defined as flowing out of the PMU. In FN mode, the PMU output is high impedance. Table 13 presents the range resistor values. Table 23 presents the DAC transfer functions.

### PMU Voltage Clamps

Voltage clamps are available on the PMU output only in the FI mode. Program the clamps with level-setting DACs CLAMPLO\_ and CLAMPHI\_. The PMU voltage clamps handle the full  $\pm 50\text{mA}$  and are triggered by the voltage at DUT\_ independent of the voltage at SENSE\_. The voltage clamps override the PMU only, and do not limit the voltage of external sources. If an external

source drives DUT\_ beyond a voltage clamp level, the PMU will current limit safely. When a PMU voltage clamp is active and at its limit, the MV and MI functions remain valid. Do not let external voltage levels at DUT\_ exceed the absolute maximum rating limits.

### PMU Current Clamps

Current clamps are available on the PMU output only in the FV mode. Program the clamps with level-setting DACs CLAMPLO\_ and CLAMPHI\_. The PMU current clamps handle the full current range ( $\pm 50\text{mA}$  for range A,  $\pm 2\text{mA}$  for range B, etc.). If the clamp currents are exceeded, the PMU enters a constant-voltage mode. The current clamp circuits override the PMU only, and do not limit external sources. When a PMU current clamp is active, the MV and MI functions are still valid.

### PMU Clamp Enable

The CLENABLE\_ bit in the PMU register enable the voltage and current clamps. Table 14 presents the clamp enable control logic.

**Table 13. Range Resistor Values**

RANGE	RESISTOR VALUE ( $\Omega$ )
A	20
B	500
C	5k
D	50k
E	500k

**Table 14. Clamp Enable Control Logic**

CLENABLE_ BIT	MODE
1	Clamps enabled
0	Clamps disabled

# Dual 1.1Gbps Pin Electronics with Integrated PMU and Level-Setting DACs

## PMU Voltage/Current-Limit Flags

The PMU features two comparators, arranged as a window comparator, to flag current or voltage levels, allowing fast go/no-go testing. The comparators monitor the load current or voltage, and compare it to level-setting DACs IVMAX and IVMIN. The MMODE\_ bit selects whether the window comparator monitors MEASV\_ or MEASI\_ (Figure 6). If MMODE\_ selects MEASV\_ then the PMUSENSE\_ bit selects either the SENSE\_ input or DUT\_ (Figure 6).

## Independent Control of PMU Feedback Switch and Measure Switch

Two single-pole/double-throw (SPDT) switches determine the mode of operation of the PMU. One switch determines whether the sensed DUT\_ current or DUT\_ voltage is fed back to the input, and thus determines which of these parameters is forced. The other switch determines whether the sensed DUT\_ current or DUT\_ voltage is presented at MEAS\_. Independent control of these switches and the force high-impedance state allow for flexible modes of operation beyond the traditional force-voltage/measure-current (FVMI) and force-current/measure-voltage (FIMV) modes. The modes supported are:

- FVMI: Force-voltage/measure-current mode
- FIMV: Force-current/measure-voltage mode
- FVMV: Force-voltage/measure-voltage mode
- FIMI: Force-current/measure-current mode
- FNMV: Force-nothing/measure-voltage mode
- FNMN: Force-nothing/measure-nothing mode

## PMU Measure Output High-Impedance Control

The MEAS\_ output features a low-leakage, high-impedance state. To activate this state, either place the HIZMEASS\_ bit low or force the HIZMEASP\_ logic input low. The two controls are logically ANDed together (Figure 6). The HIZMEASP\_ input allows multiplexing between PMU measure outputs without the use of the serial interface. At power-up, HIZMEASS\_ defaults low, placing MEAS\_ in a high-impedance state. Table 15 presents the high-impedance control logic for the MEAS\_ output.

## PMU Low-Leakage Mode

The PMU output features a low-leakage, high-impedance state. To activate this state, either place the HIZFORCE\_ bit low or force the LLEAKP\_ logic input low. The two controls are logically ANDed together (Figure 6). At power-up, HIZFORCE\_ defaults low, placing

**Table 15. Measure Output High-Impedance Control Logic**

HIZMEASS_ BIT	HIZMEASP_ INPUT	MEAS_ STATE
1	1	Measure output enabled
1	0	High impedance
0	1	High impedance
0	0	High impedance

the PMU in a low-leakage state. Table 1 presents the low-leakage logic for the PMU output.

## PMU DUT Ground Sense (DGS)

All the DAC and MEAS\_ outputs track with respect to the DUT ground sense input (DGS). Connect DGS to the ground of the device under test.

## PMU DUT\_ Node Force and Sense Switches

The MAX9979 features additional PMU force (PMU-F) and PMU sense (PMU-S) connections, through serial-controlled switches, that are shared between channels (Figure 6) and can be used to connect an external PMU. The force switch is maximum 100Ω, and the sense switch is maximum 2.5kΩ.

## PMU DUT\_ Voltage Swing vs. DUT\_ Current and Power-Supply Voltages

Two issues limit the DUT\_ voltage that the PMU delivers. The first issue is the headroom required by the amplifiers and other on-chip circuitry at zero output current. The second issue is the headroom required with sense resistor and additional circuit voltage drops at full-scale current. When the PMU is sourcing or sinking DUT\_ current, the voltage range is reduced linearly. This compliance curve applies to both FV and FI modes and is independent of VDGS. Because the forced DUT\_ voltage in FV mode is = DGS + VIN, VDUT\_ is further limited by the VDGS and the -2.5V to +7.5V VIN range. Force output capabilities of the PMU are presented in Figure 7.

These limitations are based on the guaranteed performance of the MAX9979. Operating the DUT node outside these limits will not harm the MAX9979, as long as the absolute maximum rating limits are observed. With the above considerations, it is possible to extend the range of the DUT swing beyond the limits of Figure 7. However, some specifications, such as linearity, will begin to degrade. Performance while operating outside the limits shown in Figure 7 is not guaranteed.

# Dual 1.1Gbps Pin Electronics with Integrated PMU and Level-Setting DACs

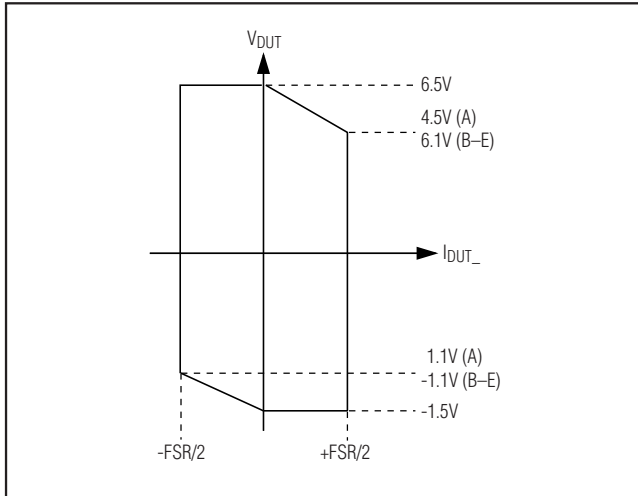

Figure 7. Output-Voltage Range

clock speeds up to 50MHz and includes the signals  $\overline{CS}$ , SCLK, DIN,  $\overline{RST}$ ,  $\overline{LOAD}$ , and DOUT. Serial-interface timing is shown in Figure 9 and timing specifications are detailed in the *Electrical Characteristics* section.

### Loading Data into the MAX9979

Load data into the 24-bit shift register from DIN on the rising edge of SCLK, while  $\overline{CS}$  is low (Figure 8). The MAX9979 is updated when the control and level-setting data are latched into the control and level-setting registers. The control and level-setting registers are separated from the shift register by the input and channel-select registers. Two methods allow data to transfer from the shift register to the control and level-setting registers, depending on the state of external digital input  $\overline{LOAD}$ .

Holding  $\overline{LOAD}$  high during the rising edge of  $\overline{CS}$  allows the shift register data to transfer only into the input and channel-select registers. Force  $\overline{LOAD}$  low to transfer the data into the control and level-setting registers. Changes update on the falling edge of  $\overline{LOAD}$ , which allows preloading of data and facilitates synchronizing updates across multiple devices.

### Serial Interface

An SPI-compatible serial interface and the logic-controlled inputs shown in Table 1 control the MAX9979. The serial interface, detailed in Figure 8, operates with

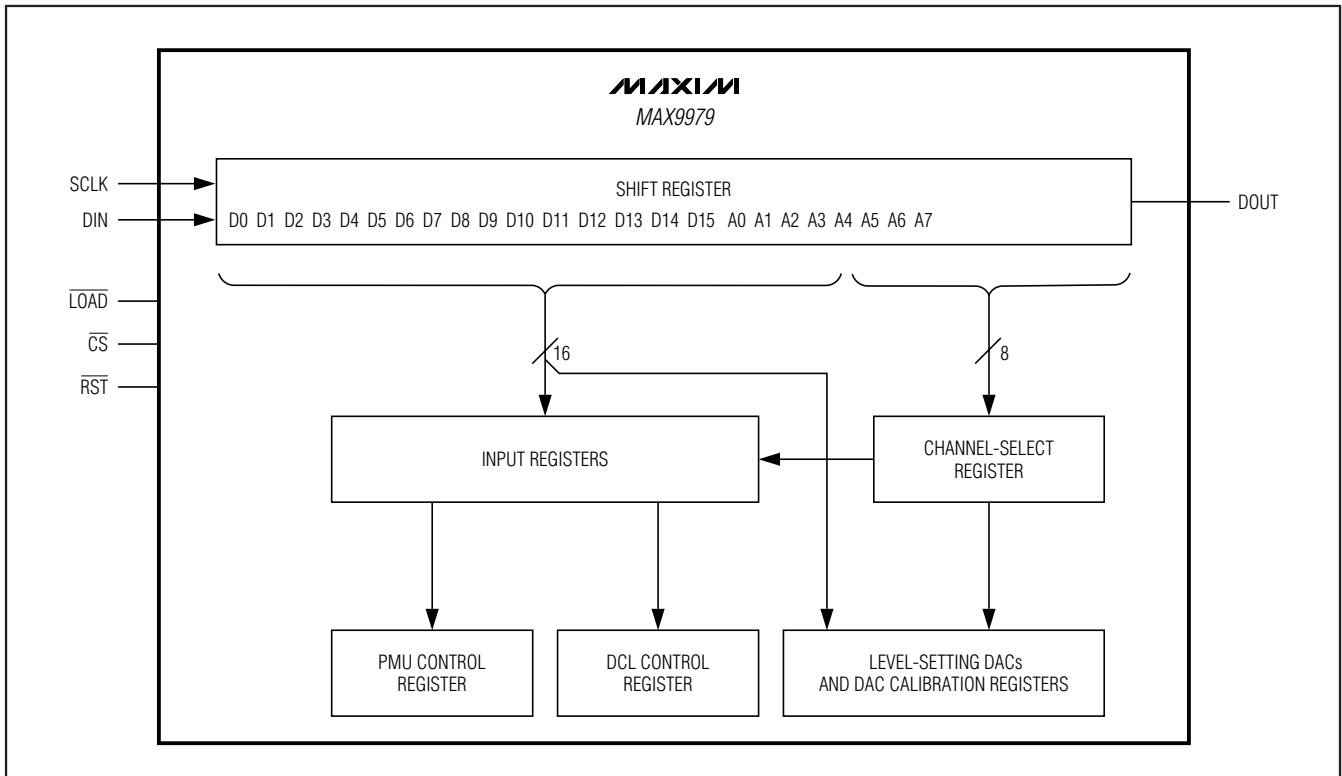

Figure 8. Serial-Interface Block Diagram

# Dual 1.1Gbps Pin Electronics with Integrated PMU and Level-Setting DACs

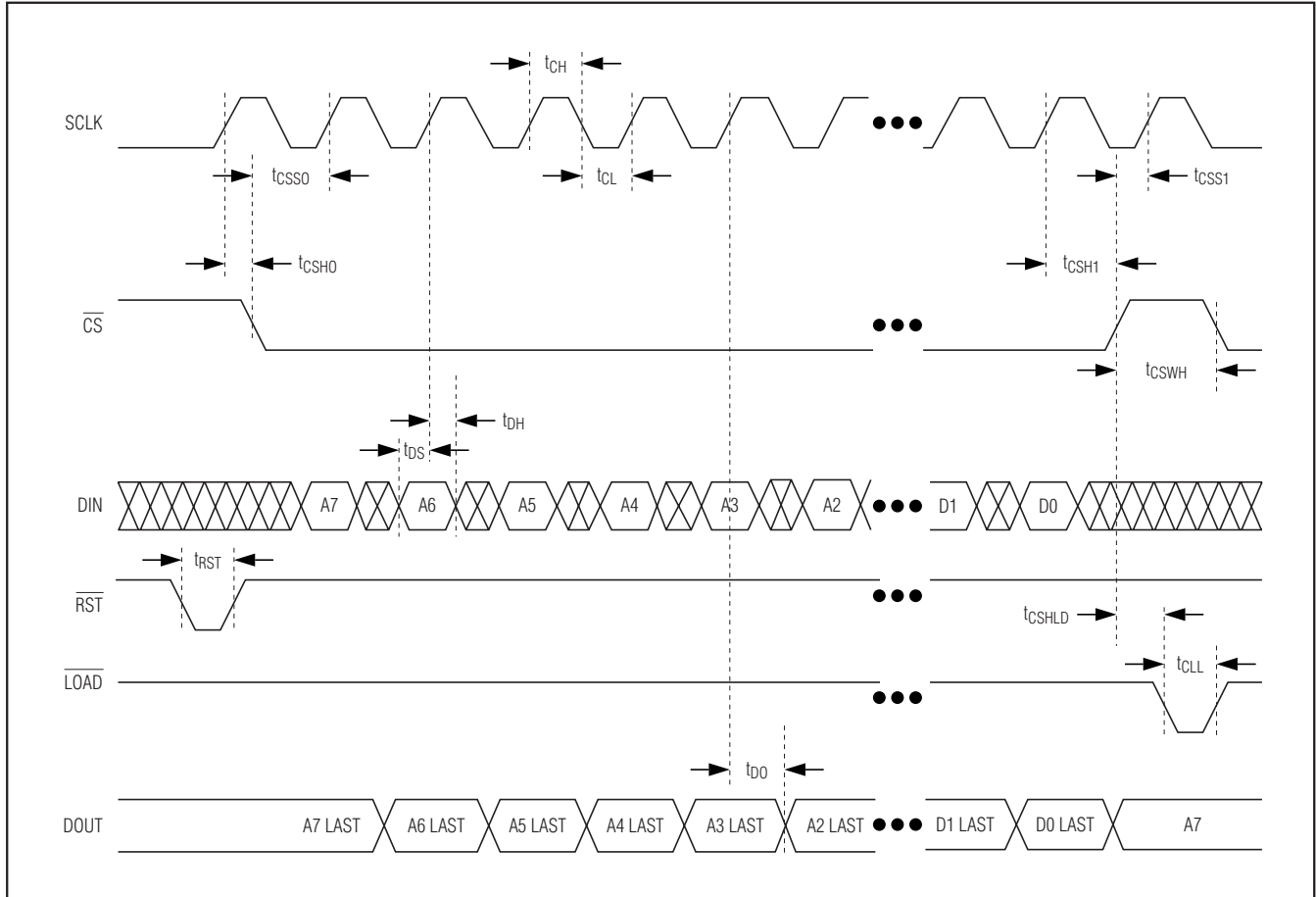

Figure 9. Serial-Interface Timing

Holding  $\overline{\text{LOAD}}$  low during the rising edge of  $\overline{\text{CS}}$  forces the input and channel-select registers to become transparent and all data transfers through these registers directly to the control and level-setting registers. Changes update on the rising edge of  $\overline{\text{CS}}$ . Figures 10 and 11 show how  $\overline{\text{LOAD}}$  and  $\overline{\text{CS}}$  function, and also the data configuration of SCLK, DIN, and DOUT.

The calibration registers change on the rising edge of  $\overline{\text{CS}}$ , regardless of the state of  $\overline{\text{LOAD}}$ .

## DOUT

DOUT is a buffered version of the last bit in the serial-interface shift register. The complete contents of the shift register can be read at DOUT during the next write cycle. To shift data out without modifying any registers, perform a write with address bits A4 and A5 set to 0. Use DOUT to daisy chain multiple devices, and/or to

verify that data were properly shifted in during the previous communication.

## Controlling the MAX9979

Control and level-setting registers are selected to receive data based on the channel and mode-select bits (A0–A7). Table 16 presents the control register bits and their functions. Level-setting DAC data and control-register data are contained in the 16 data bits D0–D16. Tables 15, 16, and 17 detail the bit functions. Clock in bit A7 first, and bit D0 last, as shown in Figure 8.

Bit A6 allows access to the DAC calibration registers. Use the calibration registers to adjust the gain and offset of each DAC. Set bit A6 to write to the calibration registers (Table 18). See the *Level-Setting DACs* section for more information.



# Dual 1.1Gbps Pin Electronics with Integrated PMU and Level-Setting DACs

MAX9979

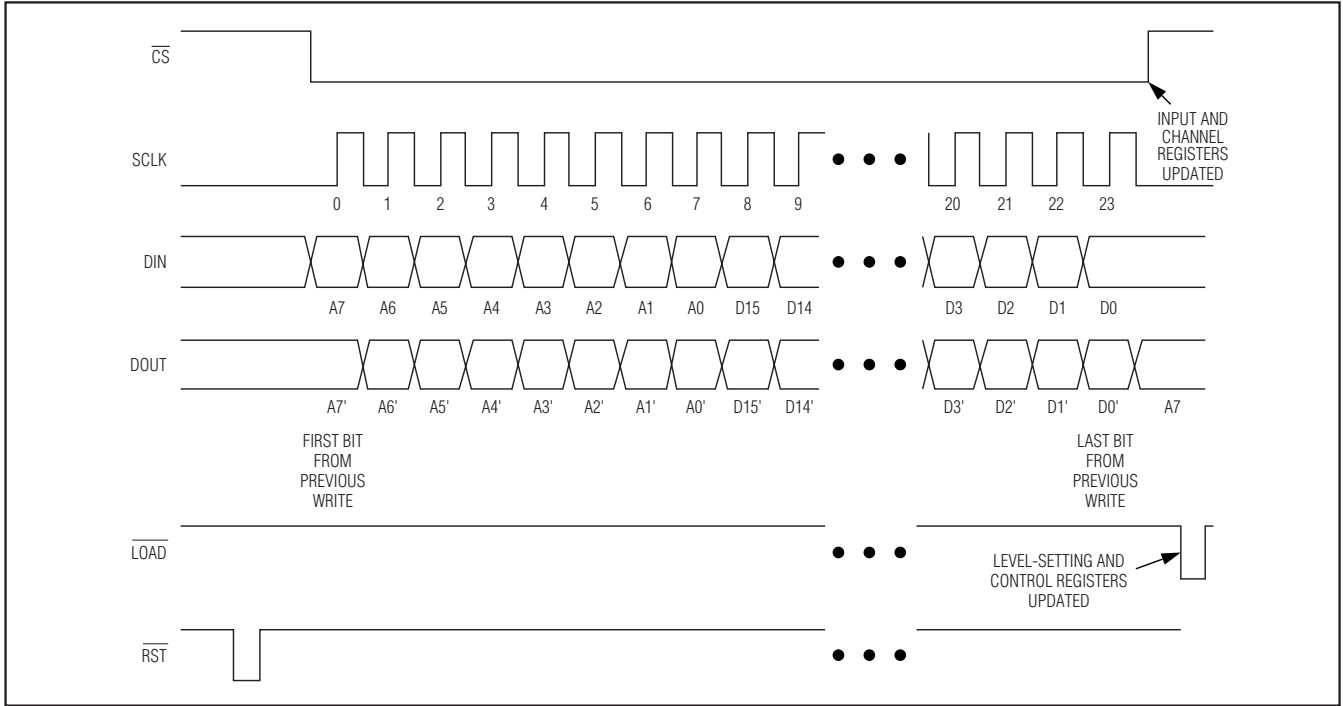

Figure 10. Using  $\overline{LOAD}$  to Update the Level-Setting and Control Registers

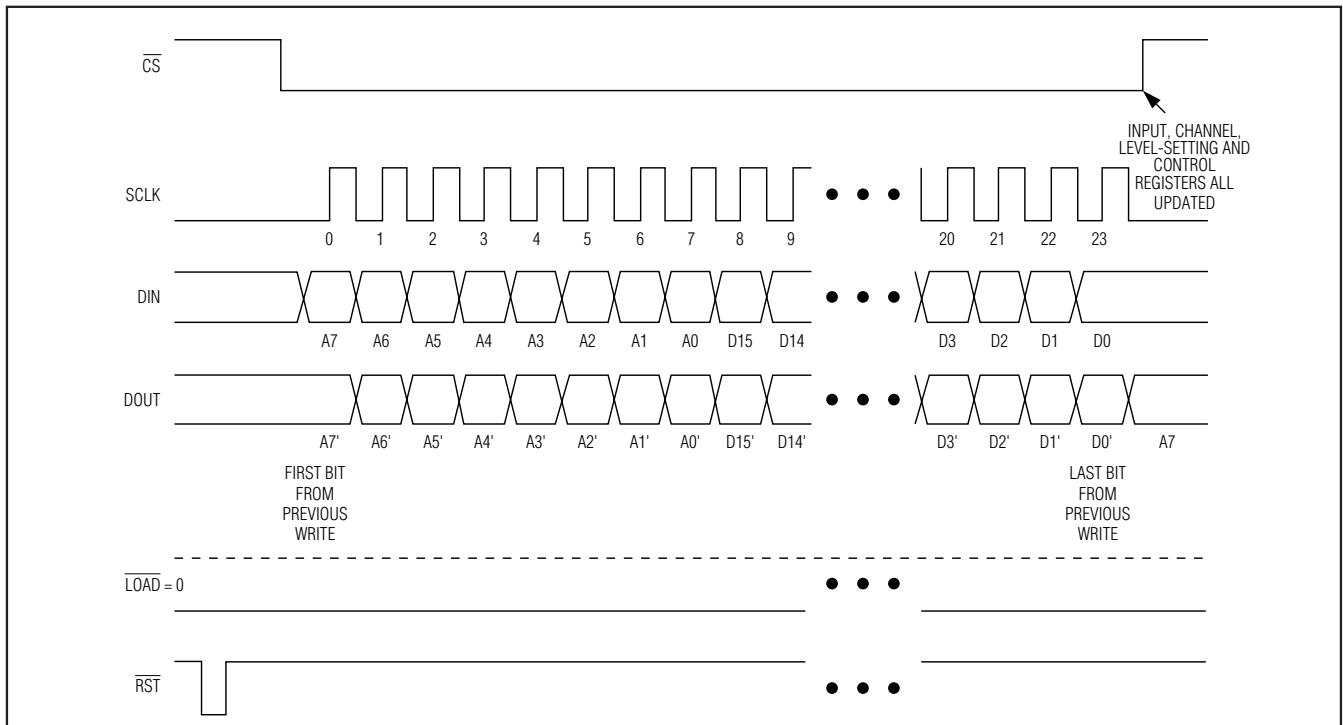

Figure 11. Using  $\overline{CS}$  to Update the Level-Setting and Control Registers ( $\overline{LOAD}$  Held Low)

# Dual 1.1Gbps Pin Electronics with Integrated PMU and Level-Setting DACs

**Table 16. MAX9979 Control and Calibration Register Bits**

REGISTER	FUNCTION
CDRP_	Driver and comparator cable-droop compensation
CLENABLE_	PMU clamp enable
DIFFERENTIAL0	Select DATA1/NDATA1 as data control for both channels 1 and 2 (Figure 3)
DIFFERENTIAL1	Enable differential comparator outputs (Figure 4)
DISABLE_	PMU comparator output disable
ENVHHS_	VHH_ mode enable
FMODE_	PMU force-mode control
GCAL_	DAC gain calibration
HIZFORCE_	PMU DUT_ high-impedance control
HIZMEASS_	PMU measure output high-impedance control
HYST_	High-speed comparator hysteresis select
HYSTEN_	PMU comparator hysteresis enable
INVERT_	DATA_/NDATA_ polarity control
LDCAL_	Load calibration enable
LDDIS_	Load disable
LLEAKS_	DCL low-leak enable
MMODE_	PMU measure-mode control
OCAL_	DAC offset calibration
PMU-F_	Force switch enable (Figure 6)
PMU-S_	Sense switch enable (Figure 6)
PMUSENSE_	PMU MEASV input control
RO_	Driver output resistance select
RS_	PMU current range select
SC_	Driver slew-rate control
TMSEL_	Driver terminate select control
TMUX_	Factory use only. Program to 0.

**Table 17. Serial-Input Data Overview**

BIT	FUNCTION
A7	Not used. Write 0 or 1
A6	Calibration register write enable
A5	Channel 1 write enable
A4	Channel 0 write enable
A3–A0	Register address (see Table 18)
D15–D0	Register data (see Table 19)

# Dual 1.1Gbps Pin Electronics with Integrated PMU and Level-Setting DACs

**Table 18. Register Address Bits**

BITS				REGISTER	
A3	A2	A1	A0	A6 = 0	A6 = 1
0	0	0	0	DCL control	DCL calibration
0	0	0	1	DHV level	DHV calibration
0	0	1	0	DLV level	DLV calibration
0	0	1	1	DTV level	DTV calibration
0	1	0	0	CHV level/PMU IVMAX	CHV calibration
0	1	0	1	CLV level/PMU IVMIN	CLV calibration
0	1	1	0	CPHV level	CPHV calibration
0	1	1	1	CPLV level	CPLV calibration
1	0	0	0	PMU control	—
1	0	0	1	VIN level	VIN calibration
1	0	1	0	VCOM level	VCOM calibration
1	0	1	1	VLDH level	VLDH calibration
1	1	0	0	VLDL level	VLDL calibration
1	1	0	1	VIOS/IIOS* level	VIOS/IIOS* calibration
1	1	1	0	CLAMPHI/VHH level	CLAMPHI/VHH calibration
1	1	1	1	CLAMPLO level	CLAMPLO calibration

\*Channel 0 register programs the VIOS level; channel 1 register programs the IIOS level. Select channels with bits A4 and A5.

**Table 19. Data Bit Assignments\***

BIT	DCL CONTROL REGISTER**	DCL CALIBRATION REGISTER**	PMU CONTROL REGISTER**	LEVEL-SETTER REGISTER	DAC GAIN AND OFFSET CALIBRATION REGISTERS	
					VIN	ALL OTHERS
D0	SC0	RO0	FMODE_	Bit 0 (LSB)	OCAL0	OCAL0
D1	SC1	RO1	MMODE_	Bit 1	OCAL1	OCAL1
D2	LLEAKS	RO2	RS0_	Bit 2	OCAL2	OCAL2
D3	TMSEL	RO3	RS1_	Bit 3	OCAL3	OCAL3
D4	LDDIS	HYST0	RS2_	Bit 4	OCAL4	OCAL4
D5	INVERT	HYST1	CLENABLE_	Bit 5	OCAL5	OCAL5
D6	DIFFERENTIAL	HYST2	HIZFORCE_	Bit 6	OCAL6	OCAL6
D7	LDCAL	CDRP0	HIZMEASS_	Bit 7	OCAL7	OCAL7
D8	ENVHHS	CDRP1	DISABLE_	Bit 8	GCAL0	GCAL0
D9	TMUX0 = 0	CDRP2	PMUSENSE_	Bit 9	GCAL1	GCAL1
D10	TMUX1 = 0	—	HYSTEN_	Bit 10	GCAL2	GCAL2

\*The data bits enter the shift register in the order, MSB to LSB.

\*\*The DCL control, DCL calibration, and PMU control registers default to 0x0004, 0x0008, and 0x0003 respectively at power-up.

# Dual 1.1Gbps Pin Electronics with Integrated PMU and Level-Setting DACs

Table 19. Data Bit Assignments\* (continued)

BIT	FUNCTION					
	DCL CONTROL REGISTER**	DCL CALIBRATION REGISTER**	PMU CONTROL REGISTER**	LEVEL-SETTER REGISTER	DAC GAIN AND OFFSET CALIBRATION REGISTERS	
					VIN	ALL OTHERS
D11	TMUX2 = 0	—	PMU-F	Bit 11	GCAL3	GCAL3
D12	TMUX3 = 0	—	PMU-S	Bit 12	GCAL4	GCAL4
D13	—	—	—	Bit 13	GCAL5	GCAL5
D14	—	—	—	Bit 14	GCAL6	—
D15	—	—	—	Bit 15 (MSB)	—	—

\*The data bits enter the shift register in the order, MSB to LSB.

\*\*The DCL control, DCL calibration, and PMU control registers default to 0x0004, 0x0008, and 0x0003 respectively at power-up.

## Level-Setting DACs

The MAX9979 includes 28 level-setting DACs that provide the DC voltage levels for the various control and monitor circuits of the 2-channel MAX9979. Some of the DACs are shared between the MAX9979 channels, and some perform dual functions within a channel (Figure 12). Important details about the operation of shared DACs are:

- VIOS share a common DAC level for both channels. VIOS DAC simultaneously updates the VIOS1 and VIOS2 levels.
- IIOS share a common DAC level for both channels. The IIOS DAC simultaneously updates the IIOS1 and IIOS2 levels.
- CLAMPHI\_ and VHH\_ share a common DAC level. The CLAMPHI\_/VHH\_ DAC simultaneously updates the CLAMPHI\_ and VHH\_ levels. Note that the VHH\_ output is 0 to +13V. If CLAMPHI\_ is set to a negative value and the VHH\_ mode is selected, the VHH\_ output limits close to 0V.
- CHV\_ and IVMAX\_ share a common DAC level. The CHV\_/IVMAX\_ DAC simultaneously updates the CHV\_ and IVMAX\_ levels.
- CLV\_ and IVMIN\_ share a common DAC level. The CLV\_/IVMIN\_ DAC simultaneously updates the CLV\_ and IVMIN\_ levels.

A 16-bit code that varies between 0x0000 and 0xFFFF sets all DAC levels. Table 20 presents a list of the DACs and their default values.

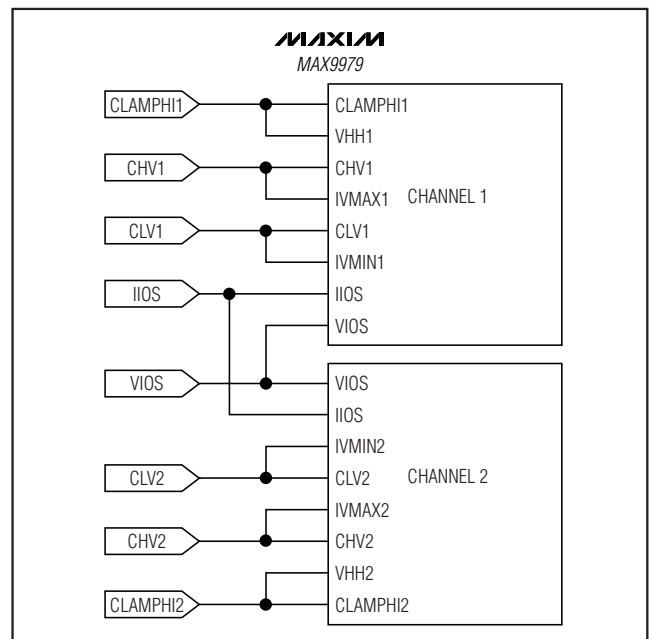

Figure 12. Arrangement of Shared DACs

## Calibrating DAC Gain and Offset

DAC calibration registers adjust the gain and offset of each DAC. Each DAC has at least one calibration register. All DAC calibration registers are programmed with a 14-bit code, except VIN\_, which uses a 15-bit code (Table 19). The codes are divided into two fields, one field each for gain (GCAL\_) and offset (OCAL\_). VIN\_ has a 7-bit field for gain and an 8-bit field for offset. All other DACs have a 6-bit field for gain and an 8-bit field for offset.

## Dual 1.1Gbps Pin Electronics with Integrated PMU and Level-Setting DACs

The VCH\_, VCL\_, and VIN\_ DACs have duplicate calibration registers that are selected and addressed as a function of the selected DCL/PMU modes. The VCH\_ and VCL\_ registers each have three separate calibration registers that are used by the window comparator, the differential comparator, and the PMU comparator, respectively. The VIN\_ register features six duplicate calibration registers that are selected as a function of the PMU force mode. These registers are individually addressed by first selecting the appropriate mode, then

performing the register write. After the calibration registers are programmed, the appropriate register is automatically switched in as a function of the operating mode.

Table 20 presents a list of the DAC registers and their default values. Calibration registers are programmed to default values only during a power-on reset. Asserting  $\overline{RST}$  does not force the calibration registers to their default values. Table 21 summarizes the DAC register addresses. Figure 13 shows how the calibration registers affect the DAC outputs.

**Table 20. DAC Power-Up and Reset Default Values**

DAC	DESCRIPTION	LEVEL-SETTING REGISTER POWER-UP AND $\overline{RST}$ VALUE	CALIBRATION REGISTER POWER-UP VALUE*
DHV_	Driver high	0x4000	0x2080
DLV_	Driver low	0x4000	0x2080
DTV_	Driver term	0x4000	0x2080
CHV_/IVMAX_	High comparator/PMU high comparator	0x4000	0x2080
CLV_/IVMIN_	Low comparator/PMU low comparator	0x4000	0x2080
CPHV_	High high-impedance clamp	0x4000	0x2080
CPLV_	Low high-impedance clamp	0x4000	0x2080
VIN_	PMU force value	0x4000	0x4080
VCOM_	Load commutation voltage	0x4000	0x2080
VLDH_	Load source current	0x4000	0x2080
VLDL_	Load sink current	0x4000	0x2080
VIOS	PMU measure voltage offset	0x4000	0x2080
IIOS	PMU force/measure current offset	0x4000	0x2080
CLAMPHI_/VHH_	PMU high clamp/driver super voltage	0x4000	0x2080
CLAMPLO_	PMU low clamp	0x4000	0x2080

\*Calibration registers not affected by  $\overline{RST}$ .

# Dual 1.1Gbps Pin Electronics with Integrated PMU and Level-Setting DACs

Table 21. DAC Level-Setting and Calibration Register Addresses

DAC	DESCRIPTION	LEVEL-SETTING REGISTER ADDRESS			CALIBRATION REGISTER ADDRESS			NOTES
		Ch 0	Ch 1	Both	Ch 0	Ch 1	Both	
DHV_	Driver high	0x11	0x21	0x31	0x51	0x61	0x71	—
DLV_	Driver low	0x12	0x22	0x32	0x52	0x62	0x72	—
DTV_	Driver term	0x13	0x23	0x33	0x53	0x63	0x73	—
CHV_/IVMAX_	High comparator/PMU high comparator	0x14	0x24	0x34	0x54	0x64	0x74	1, 3
CLV_/IVMIN_	Low comparator/PMU low comparator	0x15	0x25	0x35	0x55	0x65	0x75	2, 3
CPHV_	High high-impedance clamp	0x16	0x26	0x36	0x56	0x66	0x76	—
CPLV_	Low high-impedance clamp	0x17	0x27	0x37	0x57	0x67	0x77	—
VIN_	PMU force value	0x19	0x29	0x39	0x59	0x69	0x79	3
VCOM_	Load commutation voltage	0x1A	0x2A	0x3A	0x5A	0x6A	0x7A	—
VLDH_	Load source current	0x1B	0x2B	0x3B	0x5B	0x6B	0x7B	—
VLDL_	Load sink current	0x1C	0x2C	0x3C	0x5C	0x6C	0x7C	—
VIOS	PMU measure voltage offset	0x1D	—	—	0x5D	-	—	4
IIOS	PMU force/measure current offset	—	0x2D	—	—	0x6D	—	5
CLAMPHI_/VHH_	PMU high clamp/driver super voltage	0x1E	0x2E	0x3E	0x5E	0x6E	0x7E	3, 6
CLAMPLO_	PMU low clamp	0x1F	0x2F	0x3F	0x5F	0x6F	0x7F	—

**Note 1:** A common DAC is used for both the CHV\_ and IVMAX\_ levels.

**Note 2:** A common DAC is used for both the CLV\_ and IVMIN\_ levels.

**Note 3:** The CHV\_ and CLV\_ levels each have a pair of calibration registers. One is active when using the window comparator; the other is active when using the differential comparator. The VIN\_ level has six calibration registers corresponding to the force voltage and the five ranges of force current modes of the PMU. The CLAMPHI\_, VHH\_, IVMAX\_, and IVMIN\_ levels each have their own dedicated calibration register. Addressing any of these calibration registers requires device mode settings (Table 22) as well as the register's address.

**Note 4:** The VIOS level is common to both channels. A channel 0 DAC is used to generate VIOS.

**Note 5:** The IIOS level is common to both channels. A channel 1 DAC is used to generate IIOS.

**Note 6:** A common DAC is used for both the CLAMPHI\_ and VHH\_ levels.

# Dual 1.1Gbps Pin Electronics with Integrated PMU and Level-Setting DACs

MAX9979

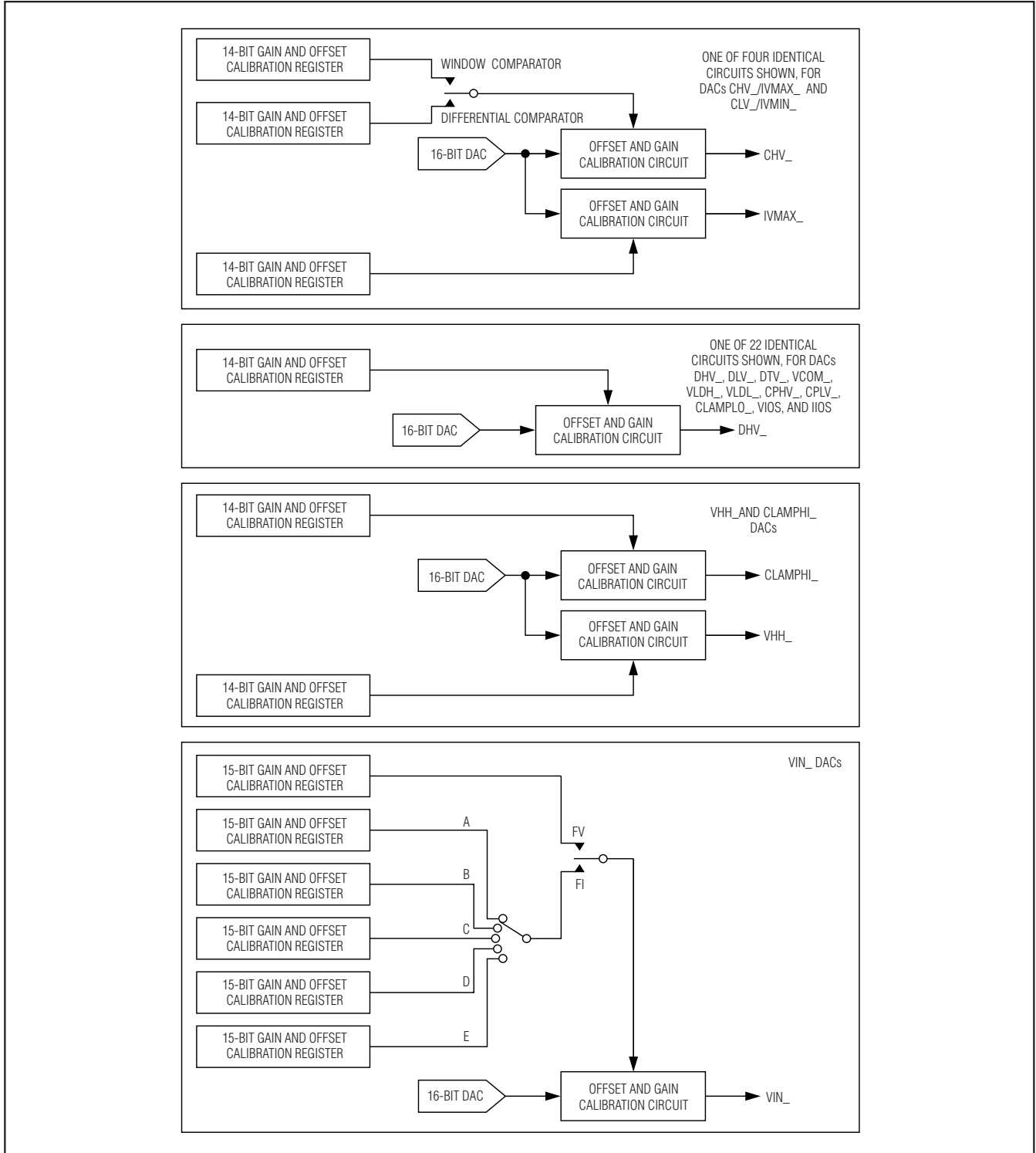

Figure 13. DAC Calibration Registers

# Dual 1.1Gbps Pin Electronics with Integrated PMU and Level-Setting DACs

An example calibration sequence follows:

- 1) Power up the MAX9979. This sets the level-setting DACs to their default 0V values, and the gain and offset calibration registers to their default midscale values (Table 20).
- 2) Gain calibration (gain must be calibrated before calibrating offset).
  - a. Program a level-setting DAC to its minimum value and measure the output voltage ( $V_{OUT\_MIN}$ ). Then, reprogram the DAC to its maximum value and again measure the output voltage ( $V_{OUT\_MAX}$ ). Calculate the gain using the following equation:

$$GAIN = \frac{V_{OUT\_MAX} - V_{OUT\_MIN}}{V_{SET\_MAX} - V_{SET\_MIN}}$$

where  $V_{SET\_MAX}$  and  $V_{SET\_MIN}$  are the desired gain calibration points.

- b. Set the DACs gain calibration register until the gain is as close to 1 as possible. This calibrates the gain for the DAC. Record the gain calibration register value for later use.

- 3) Offset calibration (must be done after the gain calibration).
      - a. Set the level of the DAC to the desired offset calibration point (e.g., midscale).
      - b. Measure  $V_{OUT\_}$  and compare it to the expected output.
      - c. Adjust the offset calibration register until  $V_{OUT\_}$  is as close as possible to the expected voltage. Record the value of the offset calibration register for later use.
    - 4) Repeat the above procedure for all DACs that need calibration, recording each of the gain and offset calibration register settings for later use.

The prior procedure only needs to be done once. Each time the power is cycled, simply reprogram the gain and offset registers using the recorded values.

Table 22 presents the mode settings required to access the calibration registers of the shared DACs. In some cases there is more than one way to access the register.

**Table 22. Mode-Control Settings to Access Calibration Registers of Shared DACs**

CALIBRATION REGISTER		SERIAL-INTERFACE BITS						
DAC	MODE	$\overline{HIZFORCE\_}$	DIFFERENTIAL1	FMODE_	MMODE_	RS_BIT		
						2	1	0
CLV_, CHV_	Window	0	0	X	X	X	X	X
	Differential	0	1	X	X	X	X	X
IVMAX_, IVMIN_	—	1	X	X	X	X	X	X
CLAMPHI_	—	1	X	X	X	X	X	X
VHH_	—	0	X	X	X	X	X	X
VIN_	FV*	0	X	X	0	X	X	X
		1	X	0	X			
	FI Range A	1	X	1	X	1	X	X
		0	X	X	1	1	X	X
	FI Range B*	0	X	X	1	0	1	1
		1	X	1	X			
	FI Range C*	0	X	X	1	0	1	0
		1	X	1	X			
	FI Range D*	0	X	X	1	0	0	1
		1	X	1	X			
	FI Range E*	0	X	X	1	0	0	0
		1	X	1	X			

\*Any of these conditions allow access to the calibration register.



# Dual 1.1Gbps Pin Electronics with Integrated PMU and Level-Setting DACs

## DAC Output Level Transfer Functions

Each of the MAX9979 analog DAC levels is set with a transfer function that includes the 16-bit DAC code setting, the gain code setting, and the offset code setting. The  $V_{DAC}$  and  $V_{INDAC}$  expressions below present the basic DAC transfer functions. Each DAC has a voltage output range of -2.5V to +7.5V (typ). Thirteen of these DACs are identical and generate a potential according to the following equation:

$$V_{DAC} = \left( \left( \frac{DAC_{CODE} - 1}{16384} \right) \times (V_{REF} - V_{DGS}) + ((OFFSET_{CODE} \times 0.001) - 0.128) \right) \times \left( 0.98 + 0.02 \times \left( \frac{GAIN_{CODE}}{32} \right) \right) + V_{DGS}$$

A separate DAC ( $V_{IN\_}$ ) is used for the PMU force value. This DAC has a finer gain adjustment resolution and follows the equation:

$$V_{INDAC} = \left( \left( \frac{DAC_{CODE} - 1}{16384} \right) \times (V_{REF} - V_{DGS}) + ((OFFSET_{CODE} \times 0.001) - 0.128) \right) \times \left( 0.98 + 0.02 \times \left( \frac{GAIN_{CODE}}{64} \right) \right) + V_{DGS}$$

For all DACs, the offset code is an integer value between 0 and 255. The  $V_{IN\_DAC}$  gain code is an integer value between 0 and 127, and for all other DACs the gain code is an integer value between 0 and 63. Offset and gain codes are based on the calibration register settings.

**Table 23. DAC Transfer Functions**

LEVEL	LEVEL TRANSFER FUNCTION
DHV_	$V_{DAC} \times DHV\_gain + DHV\_offset$
DLV_	$V_{DAC} \times DLV\_gain + DLV\_offset$
DTV_	$V_{DAC} \times DTV\_gain + DTV\_offset$
CHV_	$V_{DAC} \times CHV\_gain + CHV\_offset$
IVMAX_	$V_{DAC} \times IVMAX\_gain + IVMAX\_offset$
CLV_	$V_{DAC} \times CLV\_gain + CLV\_offset$
IVMIN_	$V_{DAC} \times IVMIN\_gain + IVMIN\_offset$
CPHV_	$V_{DAC} \times CPHV\_gain + CPHV\_offset$
CPLV_	$V_{DAC} \times CPLV\_gain + CPLV\_offset$
VIN_ (FVMI)	$V_{INDAC} \times PMU\_FV\_gain + PMU\_FV\_offset$
VIN_ (FIMV 50mA)	$(V_{INDAC} - V_{IIOs}) \times (50mA/4V) \times PMU\_FI\_gain + PMU\_FI\_offset$
VIN_ (FIMV 2mA)	$(V_{INDAC} - V_{IIOs}) \times (2mA/4V) \times PMU\_FI\_gain + PMU\_FI\_offset$
VIN_ (FIMV 200_A)	$(V_{INDAC} - V_{IIOs}) \times (200\_A/4V) \times PMU\_FI\_gain + PMU\_FI\_offset$
VIN_ (FIMV 20_A)	$(V_{INDAC} - V_{IIOs}) \times (20\_A/4V) \times PMU\_FI\_gain + PMU\_FI\_offset$
VIN_ (FIMV 2_A)	$(V_{INDAC} - V_{IIOs}) \times (2\_A/4V) \times PMU\_FI\_gain + PMU\_FI\_offset$
VCOM_	$V_{DAC} \times VCOM\_gain + VCOM\_offset$
VLDH_	$(V_{DAC} - DGS) \times (20mA/6V) \times VLDH\_gain + VLDH\_offset$
VLDL_	$(V_{DAC} - DGS) \times (20mA/6V) \times VLDL\_gain + VLDL\_offset$
VIOS	$((V_{DAC} + DGS)/2) \times VIOS\_gain + VIOS\_offset$
IIOS	$((V_{DAC} + REF)/2) \times IIOS\_gain + IIOS\_offset$
VHH_	$(V_{DAC} - DGS) \times 2 \times VHH\_gain + VHH\_offset + DGS$
CLAMPHI_ (Voltage)	$V_{DAC} \times CLAMPHI\_gain + CLAMPHI\_offset$
CLAMPHI_ (Current)	$(V_{DAC} - V_{IIOs}) \times FSR/2V \times CLAMPHI\_gain + CLAMPHI\_offset$
CLAMPLO_ (Voltage)	$V_{DAC} \times CLAMPLO\_gain + CLAMPLO\_offset$
CLAMPLO_ (Current)	$(V_{DAC} - V_{IIOs}) \times FSR/2V \times CLAMP\_LO\_gain + CLAMPLO\_offset$

- Values for  $PMU\_FI\_gain$  and  $PMU\_FI\_offset$  are different for each PMU current range.
- $VLDH\_$  and  $VLDL\_$  levels less than zero are truncated.
- Full-scale range is dependent upon the PMU current range. Values are 100mA, 4mA, 400µA, 40µA, and 4µA for ranges A–E, respectively.
- Values for  $CLAMPHI\_gain$ ,  $CLAMPLO\_gain$ ,  $CLAMPHI\_offset$ , and  $CLAMPLO\_offset$  vary with PMU force mode and current range.

# Dual 1.1Gbps Pin Electronics with Integrated PMU and Level-Setting DACs

The V<sub>DAC</sub> voltages are then utilized for the various signal paths within the MAX9979 (i.e., driver level DHV<sub>-</sub>). Each of these signal paths have inherent gain and offset errors, denoted as *\_gain* and *\_offset* terms in the Level Transfer Function column in Table 23. These error terms are presented to convey the non-ideal gain and offset of the signal paths—they do not have a specified value. The GAINCODE and OFFSETCODE features of each DAC are designed to correct for these errors to make the level transfer function expressions, and therefore, the final signal path outputs (e.g., DHV<sub>-</sub>) more ideal.

## Applications Information

### Device Power-Up State

Upon power-up, the DCL enters low-leak mode and the PMU enters high-impedance mode. The DCL control, DCL calibration, and PMU control registers default to

0x0004, 0x0008, and 0x0003, respectively. For initial power-up values for the level-setting registers, see Table 20. Power supplies may be powered on in any sequence.

### Power-Supply Considerations

Bypass each supply input to GND and REF to DGS with 0.1μF capacitors (Figure 13). Additionally, use bulk bypassing of at least 10μF where the power-supply connections meet the circuit board.

### Exposed Pad

The exposed pad is internally connected to ground. Connect to a open copper PCB ground plane or heatsink to maximize thermal performance. Not intended as an electrical connection point.

## Pin Configuration

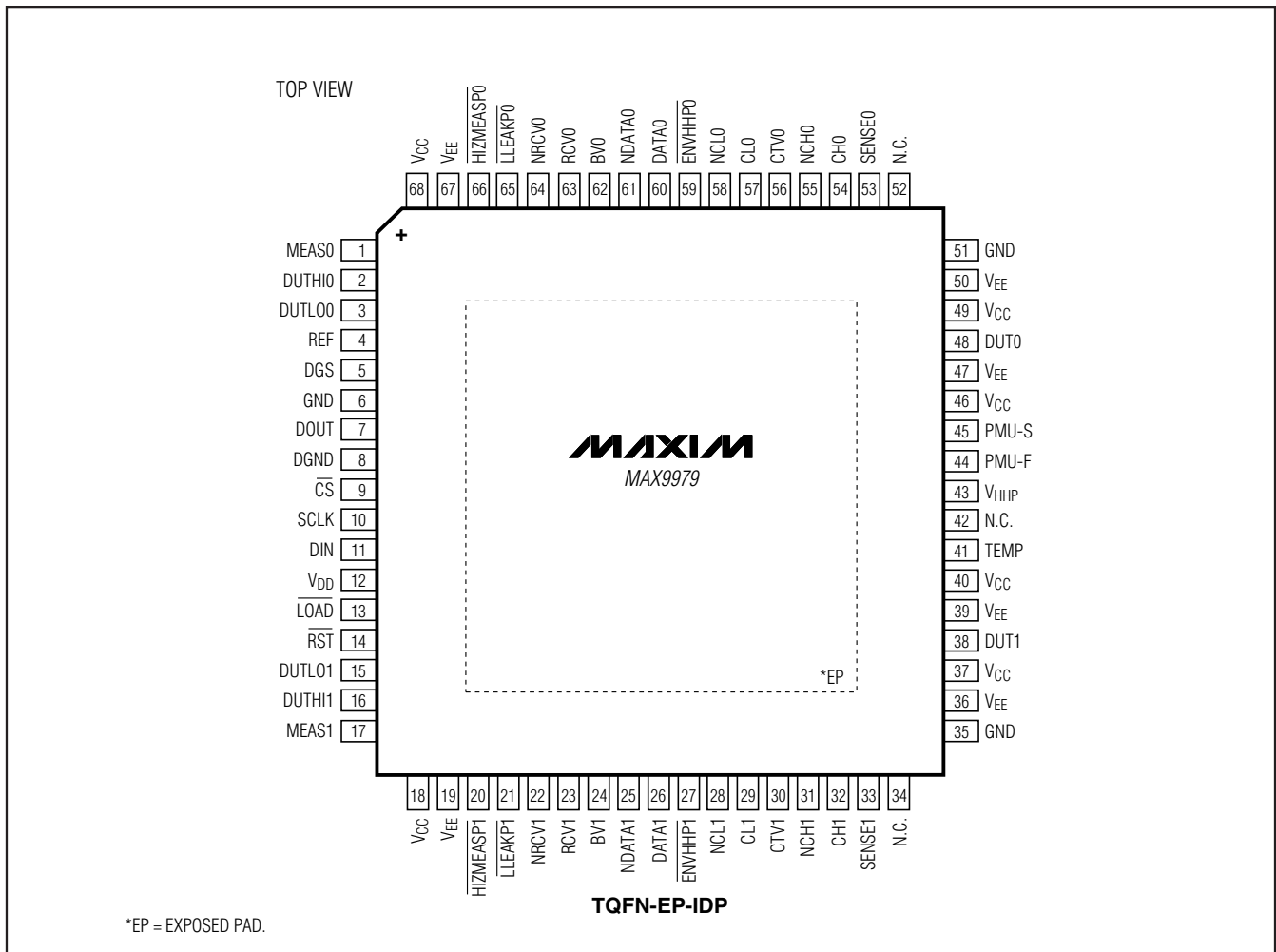

# Dual 1.1Gbps Pin Electronics with Integrated PMU and Level-Setting DACs

## Typical Operating Circuit

MAX9979

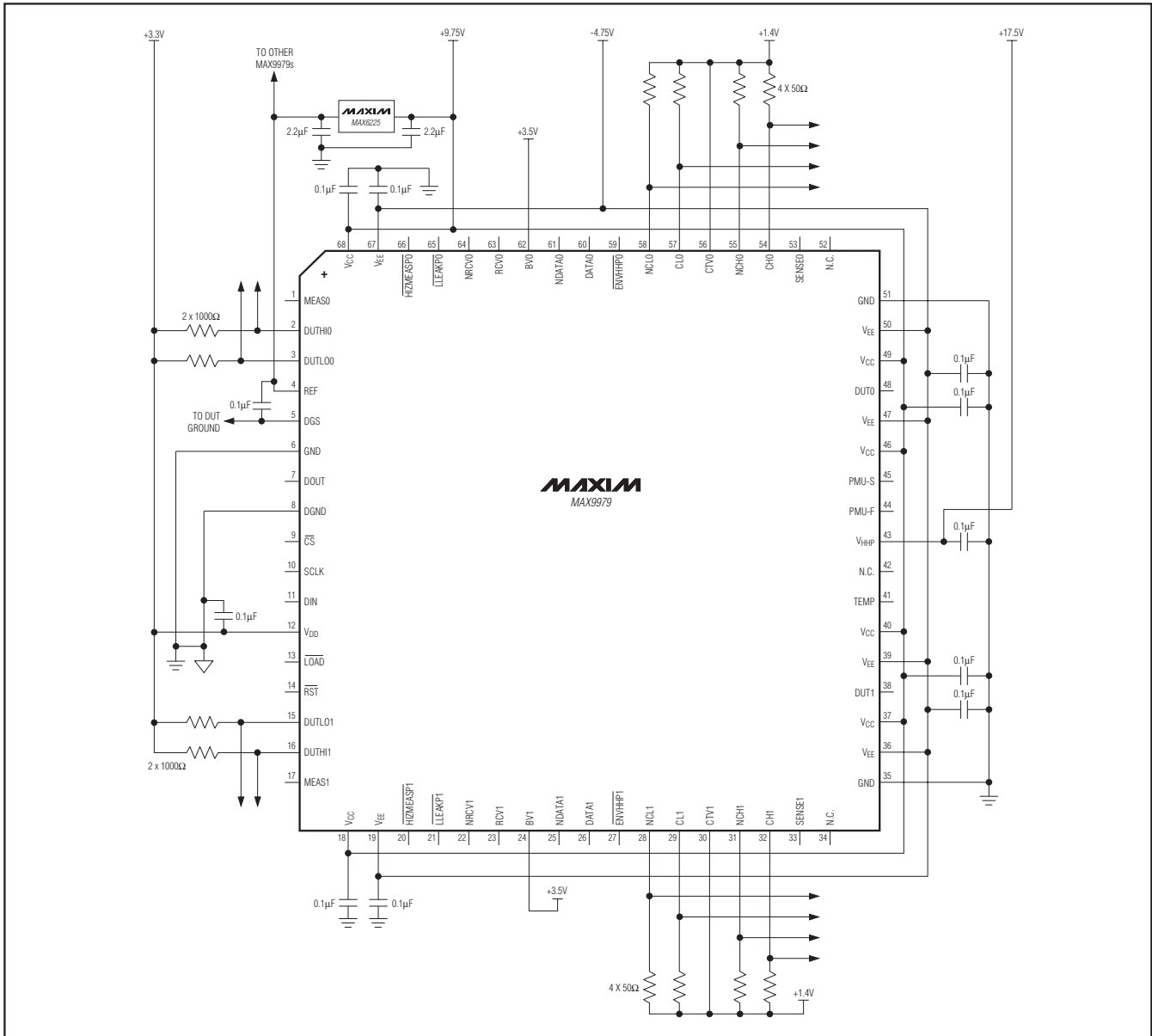

### Chip Information

PROCESS: BiCMOS

### Package Information

For the latest package outline information and land patterns (footprints), go to [www.maxim-ic.com/packages](http://www.maxim-ic.com/packages). Note that a "+", "#", or "-" in the package code indicates RoHS status only. Package drawings may show a different suffix character, but the drawing pertains to the package regardless of RoHS status.

PACKAGE TYPE	PACKAGE CODE	OUTLINE NO.	LAND PATTERN NO.
68 TQFN-EP-IDP	T6800RN+6	<a href="#">21-0192</a>	<a href="#">90-0090</a>

# Dual 1.1Gbps Pin Electronics with Integrated PMU and Level-Setting DACs

## Revision History

REVISION NUMBER	REVISION DATE	DESCRIPTION	PAGES CHANGED
0	6/08	Initial release	—
1	10/08	Corrected error in Table 2 and formula on page 57	36, 57
2	12/08	Added new Tables 6 and 7 and renumbered subsequent tables	37, 38, 41, 42, 44, 45, 46, 48, 50–54, 56, 57, 58
3	4/09	Made spec changes and clarifications	5–8, 20, 57
4	6/09	Corrected <i>Typical Operating Circuit</i>	59
5	1/11	Updated <i>Pin Description</i> , <i>Exposed Pad</i> section, and <i>Package Information</i>	33, 58, 59
6	8/11	Clarified use of exposed die attach pad	33, 58

Maxim cannot assume responsibility for use of any circuitry other than circuitry entirely embodied in a Maxim product. No circuit patent licenses are implied. Maxim reserves the right to change the circuitry and specifications without notice at any time.

60 **Maxim Integrated Products, 120 San Gabriel Drive, Sunnyvale, CA 94086 408-737-7600**

© 2011 Maxim Integrated Products

Maxim is a registered trademark of Maxim Integrated Products, Inc.