



Vincotech

flow PIM 2 3rd

1200 V / 100 A

Features

- 3~rectifier,BRC,Inverter, NTC
- Very Compact housing, easy to route
- IGBT4/ EmCon4 technology for low saturation losses and improved EMC behavior

Target Applications

- Motor Drives
- Power Generation

Types

- V23990-P760-A-PM

flow 2 housing

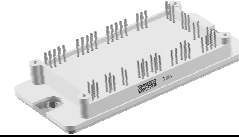

Schematic

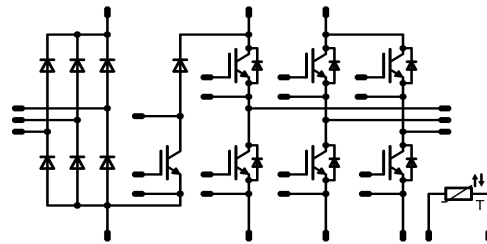

Maximum Ratings

T_j=25°C, unless otherwise specified

Parameter	Symbol	Condition	Value	Unit
-----------	--------	-----------	-------	------

Input Rectifier Diode

Repetitive peak reverse voltage	V _{RRM}		1600	V
Forward current	I _{FAV}	DC current T _h =80°C T _c =80°C	100 100	A
Surge forward current	I _{FSM}	t _p =10ms T _j =25°C	1000	A
I ² t-value	I ² t		5000	A ² s
Power dissipation	P _{tot}	T _j =T _{jmax} T _h =80°C T _c =80°C	114 172	W
Maximum Junction Temperature	T _{jmax}		150	°C

Inverter IGBT

Collector-emitter break down voltage	V _{CE}		1200	V
DC collector current	I _C	T _j =T _{jmax} T _h =80°C T _c =80°C	105 120	A
Repetitive peak collector current	I _{Cpulse}	t _p limited by T _{jmax}	300	A
Power dissipation	P _{tot}	T _j =T _{jmax} T _h =80°C T _c =80°C	263 398	W
Gate-emitter peak voltage	V _{GE}		±20	V
Short circuit ratings	t _{SC} V _{CC}	T _j ≤150°C V _{GE} =15V	10 800	µs V
Maximum Junction Temperature	T _{jmax}		175	°C



Maximum Ratings

T_j=25°C, unless otherwise specified

Parameter	Symbol	Condition	Value	Unit
-----------	--------	-----------	-------	------

Inverter FWD

Peak Repetitive Reverse Voltage	V _{RRM}		1200	V
DC forward current	I _F	T _j =T _{jmax} T _h =80°C T _c =80°C	86 114	A
Repetitive peak forward current	I _{FRM}	t _p limited by T _{jmax}	200	A
Power dissipation	P _{tot}	T _j =T _{jmax} T _h =80°C T _c =80°C	150 230	W
Maximum Junction Temperature	T _{jmax}		175	°C

Brake IGBT

Collector-emitter break down voltage	V _{CE}		1200	V
DC collector current	I _C	T _j =T _{jmax} T _h =80°C T _c =80°C	59 76	A
Repetitive peak collector current	I _{Cpuls}	t _p limited by T _{jmax}	150	A
Power dissipation	P _{tot}	T _j =T _{jmax} T _h =80°C T _c =80°C	159 241	W
Gate-emitter peak voltage	V _{GE}		±20	V
Short circuit ratings	t _{SC} V _{CC}	T _j ≤150°C V _{GE} =15V	10 900	μs V
Maximum Junction Temperature	T _{jmax}		175	°C

Brake Inverse Diode

Peak Repetitive Reverse Voltage	V _{RRM}		1200	V
DC forward current	I _F	T _j =T _{jmax} T _h =80°C T _c =80°C	20 20	A
Repetitive peak forward current	I _{FRM}	t _p limited by T _{jmax}	20	A
Brake Inverse Diode	P _{tot}	T _j =T _{jmax} T _h =80°C T _c =80°C	52 79	W
Maximum Junction Temperature	T _{jmax}		175	°C

Brake FWD

Peak Repetitive Reverse Voltage	V _{RRM}		1200	V
DC forward current	I _F	T _j =T _{jmax} T _h =80°C T _c =80°C	35 40	A
Repetitive peak forward current	I _{FRM}	t _p limited by T _{jmax}	50	A
Power dissipation	P _{tot}	T _j =T _{jmax} T _h =80°C T _c =80°C	75 114	W
Maximum Junction Temperature	T _{jmax}		175	°C



Maximum Ratings

T_j=25°C, unless otherwise specified

Parameter	Symbol	Condition	Value	Unit
Thermal properties				
Storage temperature	T _{stg}		-40...+125	°C
Operation temperature under switching condition	T _{op}		-40...+T _{jmax} -25	°C
Insulation properties				
Insulation voltage	V _{is}	t=1min	4000	V _{DC}
Creepage distance			min 12,7	mm
Clearance			min 12,7	mm

Characteristic Values

Parameter	Symbol	Conditions					Value			Unit
		V_{GE} [V] or V_{GS} [V]	V_r [V] or V_{CE} [V] or V_{DS} [V]	I_c [A] or I_F [A] or I_D [A]	T_j	Min	Typ	Max		

Input Rectifier Diode

Forward voltage	V_F				100	$T_j=25^\circ\text{C}$ $T_j=125^\circ\text{C}$	1,18 1,16	1,9		V
Threshold voltage (for power loss calc. only)	V_{to}				100	$T_j=25^\circ\text{C}$ $T_j=125^\circ\text{C}$	0,88 0,75			V
Slope resistance (for power loss calc. only)	r_t				100	$T_j=25^\circ\text{C}$ $T_j=125^\circ\text{C}$	0,003 0,004			Ω
Reverse current	I_r			1500		$T_j=25^\circ\text{C}$ $T_j=125^\circ\text{C}$		0,05 1,1		mA
Thermal resistance chip to heatsink	R_{thJH}	Thermal grease thickness $\leq 50\mu\text{m}$					0,62			K/W
Thermal resistance chip to case	R_{thJC}	$\lambda = 0,61$					0,41			

Inverter IGBT

Gate emitter threshold voltage	$V_{GE(th)}$	$V_{CE}=V_{GE}$			0,0034	$T_j=25^\circ\text{C}$ $T_j=150^\circ\text{C}$	5	5,8	6,5	V
Collector-emitter saturation voltage	$V_{CE(sat)}$		15		100	$T_j=25^\circ\text{C}$ $T_j=150^\circ\text{C}$		1,9 2,34	2,5	V
Collector-emitter cut-off current incl. Diode	I_{CES}		0	1200		$T_j=25^\circ\text{C}$ $T_j=150^\circ\text{C}$			0,03	mA
Gate-emitter leakage current	I_{GES}		20	0		$T_j=25^\circ\text{C}$ $T_j=150^\circ\text{C}$			700	nA
Integrated Gate resistor	R_{gint}							2		Ω
Turn-on delay time	$t_{d(on)}$	$R_{goff}=4 \Omega$ $R_{gon}=4 \Omega$	± 15	600	100	$T_j=25^\circ\text{C}$ $T_j=150^\circ\text{C}$	126 130		ns	
Rise time	t_r					$T_j=25^\circ\text{C}$ $T_j=150^\circ\text{C}$	17 22			
Turn-off delay time	$t_{d(off)}$					$T_j=25^\circ\text{C}$ $T_j=150^\circ\text{C}$	242 316			
Fall time	t_f					$T_j=25^\circ\text{C}$ $T_j=150^\circ\text{C}$	63 115			
Turn-on energy loss per pulse	E_{on}					$T_j=25^\circ\text{C}$ $T_j=150^\circ\text{C}$	4,07 6,64	mWs		
Turn-off energy loss per pulse	E_{off}					$T_j=25^\circ\text{C}$ $T_j=150^\circ\text{C}$	5,22 8,71			
Input capacitance	C_{ies}						5540		pF	
Output capacitance	C_{oss}	$f=1\text{MHz}$	0	25		$T_j=25^\circ\text{C}$	410			
Reverse transfer capacitance	C_{rss}						320			
Gate charge	Q_{Gate}		± 15			$T_j=25^\circ\text{C}$	580		nC	
Thermal resistance chip to heatsink	R_{thJH}						0,36		K/W	
Thermal resistance chip to case	R_{thJC}	Thermal grease thickness $\leq 50\mu\text{m}$					0,24			
Coupled thermal resistance transistor-transistor	$R_{thJHT-T}$	$\lambda = 0,61 \text{ W/m}\cdot\text{K}$					0,08			
Coupled thermal resistance diode-transistor	$R_{thJHD-T}$						0,08			

Inverter FWD

Diode forward voltage	V_F				100	$T_j=25^\circ\text{C}$ $T_j=150^\circ\text{C}$	1,83 1,86	2,4		V
Peak reverse recovery current	I_{RRM}	$R_{gon}=4 \Omega$	± 15	600	100	$T_j=25^\circ\text{C}$ $T_j=150^\circ\text{C}$	167 191		A	
Reverse recovery time	t_{rr}					$T_j=25^\circ\text{C}$ $T_j=150^\circ\text{C}$	134 293			
Reverse recovered charge	Q_{rr}					$T_j=25^\circ\text{C}$ $T_j=150^\circ\text{C}$	9,39 19,67	μC		
Peak rate of fall of recovery current	$di(rec)_{max}/dt$					$T_j=25^\circ\text{C}$ $T_j=150^\circ\text{C}$	7887 3332			
Reverse recovered energy	E_{rec}					$T_j=25^\circ\text{C}$ $T_j=150^\circ\text{C}$	3,82 8,55	mWs		
Thermal resistance chip to heatsink	R_{thJH}									
Thermal resistance chip to case	R_{thJC}	Thermal grease thickness $\leq 50\mu\text{m}$					0,41			
Coupled thermal resistance diode-diode	$R_{thJHD-D}$	$\lambda = 0,61 \text{ W/m}\cdot\text{K}$								
Coupled thermal resistance transistor-diode	$R_{thJHT-D}$						0,07			

Characteristic Values

Parameter	Symbol	Conditions					Value			Unit
		V_{GE} [V] or V_{GS} [V]	V_r [V] or V_{CE} [V] or V_{DS} [V]	I_c [A] or I_F [A] or I_D [A]	T_j	Min	Typ	Max		
Brake IGBT										
Gate emitter threshold voltage	$V_{GE(th)}$	$V_{CE}=V_{GE}$			0,0017	$T_j=25^\circ\text{C}$ $T_j=150^\circ\text{C}$	5	5,8	6,5	V
Collector-emitter saturation voltage	$V_{CE(sat)}$		15		50	$T_j=25^\circ\text{C}$ $T_j=150^\circ\text{C}$		1,84 2,27	2,3	V
Collector-emitter cut-off incl diode	I_{CES}		0	1200		$T_j=25^\circ\text{C}$ $T_j=150^\circ\text{C}$			0,25	mA
Gate-emitter leakage current	I_{GES}		20	0		$T_j=25^\circ\text{C}$ $T_j=150^\circ\text{C}$			700	nA
Integrated Gate resistor	R_{gint}							4		Ω
Turn-on delay time	$t_{d(on)}$	$R_{goff}=8\ \Omega$ $R_{gon}=8\ \Omega$	± 15	600	50	$T_j=25^\circ\text{C}$		117		ns
Rise time	t_r					$T_j=150^\circ\text{C}$		121		
Turn-off delay time	$t_{d(off)}$					$T_j=25^\circ\text{C}$		18		
Fall time	t_f					$T_j=150^\circ\text{C}$		24		
Turn-on energy loss per pulse	E_{on}					$T_j=25^\circ\text{C}$		249		
Turn-off energy loss per pulse	E_{off}					$T_j=150^\circ\text{C}$		316		
Input capacitance	C_{ies}	$f=1\text{MHz}$	0	25		$T_j=25^\circ\text{C}$		2770		pF
Output capacitance	C_{oss}							205		
Reverse transfer capacitance	C_{rss}							160		
Gate charge	Q_{Gate}		± 15	960		$T_j=25^\circ\text{C}$		290		nC
Thermal resistance chip to heatsink	R_{thJH}	Thermal grease thickness $\leq 50\mu\text{m}$						0,6		K/W
Thermal resistance chip to case	R_{thJC}	$\lambda = 0,61\ \text{W/m}\cdot\text{K}$						0,39		
Brake Inverse Diode										
Diode forward voltage	V_F				10	$T_j=25^\circ\text{C}$ $T_j=150^\circ\text{C}$	1,1	1,84 1,8	2,1	V
Thermal resistance chip to heatsink	R_{thJH}	Thermal grease thickness $\leq 50\mu\text{m}$						1,81		K/W
Thermal resistance chip to case	R_{thJC}	$\lambda = 0,61\ \text{W/m}\cdot\text{K}$						1,20		K/W
Brake FWD										
Diode forward voltage	V_F				25	$T_j=25^\circ\text{C}$ $T_j=150^\circ\text{C}$		1,87 1,83	2,2	V
Reverse leakage current	I_r		± 15	600	50	$T_j=25^\circ\text{C}$ $T_j=150^\circ\text{C}$			10	μA
Peak reverse recovery current	I_{RRM}	$R_{gon}=8\ \Omega$	± 15	600	50	$T_j=25^\circ\text{C}$		54,29		A
Reverse recovery time	t_{rr}					$T_j=150^\circ\text{C}$		78,18		
Reverse recovered charge	Q_{rr}					$T_j=25^\circ\text{C}$		158,7		
Peak rate of fall of recovery current	$\frac{di(rec)_{max}}{dt}$					$T_j=150^\circ\text{C}$		295,4		
Reverse recovery energy	E_{rec}					$T_j=25^\circ\text{C}$		3,21		
						$T_j=150^\circ\text{C}$		6,6		
Thermal resistance chip to heatsink	R_{thJH}	Thermal grease thickness $\leq 50\mu\text{m}$						1,27		K/W
Thermal resistance chip to case	R_{thJC}	$\lambda = 0,61\ \text{W/m}\cdot\text{K}$						0,84		
Thermistor										
Rated resistance	R_{25}	Tol. $\pm 5\%$				$T_j=25^\circ\text{C}$	20,9	22	23,1	k Ω
Deviation of R100	$D_{R/R}$	$R_{100}=1486.1\Omega$				$T_c=100^\circ\text{C}$		2,9		%/K
Power dissipation given Epcos-Typ	P					$T_j=25^\circ\text{C}$		210		mW
B-value	$B_{(25/100)}$	Tol. $\pm 3\%$				$T_j=25^\circ\text{C}$		4000		K



Output Inverter

Figure 1 Output inverter IGBT

Typical output characteristics

$I_C = f(V_{CE})$

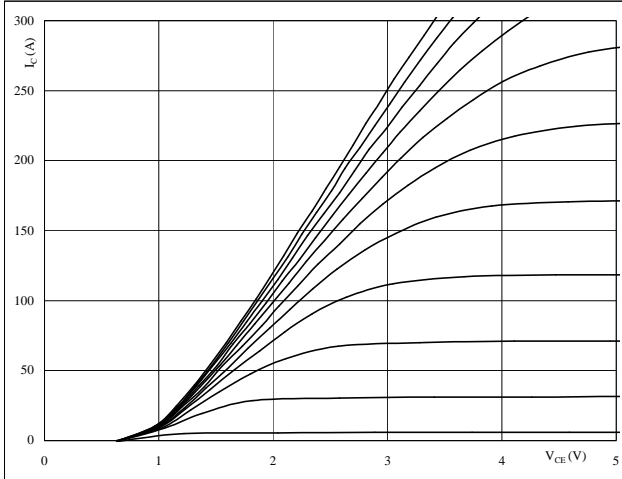

At
 $t_p = 250 \mu s$
 $T_j = 25 \text{ }^\circ C$
VGE from 7 V to 17 V in steps of 1 V

Figure 2 Output inverter IGBT

Typical output characteristics

$I_C = f(V_{CE})$

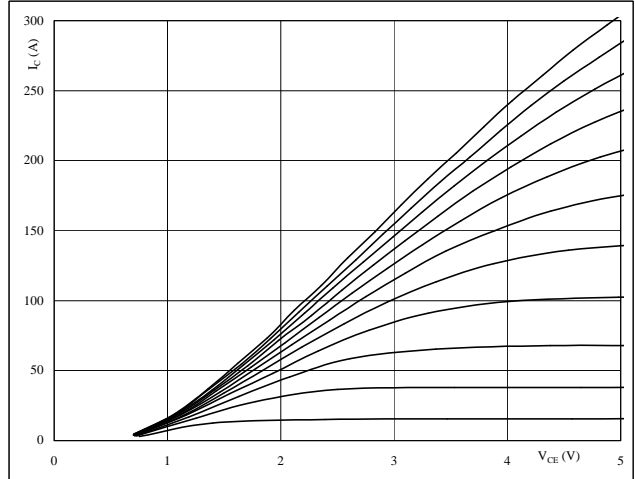

At
 $t_p = 250 \mu s$
 $T_j = 150 \text{ }^\circ C$
VGE from 7 V to 17 V in steps of 1 V

Figure 3 Output inverter IGBT

Typical transfer characteristics

$I_C = f(V_{GE})$

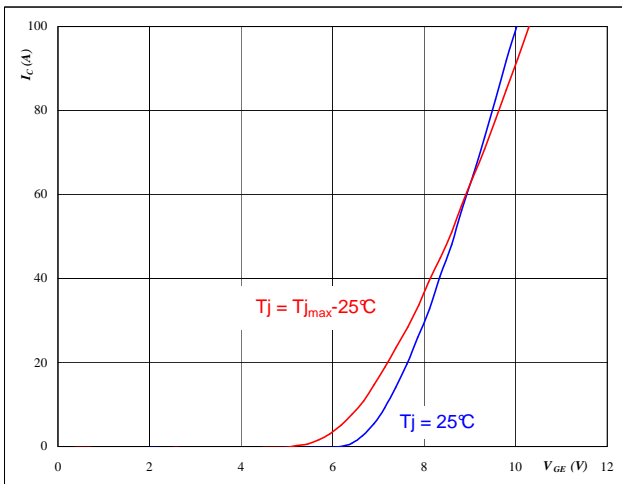

At
 $t_p = 250 \mu s$
 $V_{CE} = 10 V$

Figure 4 Output inverter FWD

Typical diode forward current as a function of forward voltage

$I_F = f(V_F)$

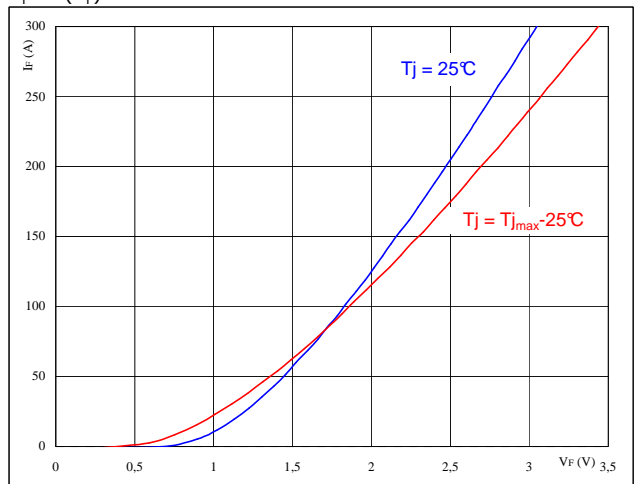

At
 $t_p = 250 \mu s$



Output Inverter

Figure 5 Output inverter IGBT

Typical switching energy losses
as a function of collector current

$E = f(I_C)$

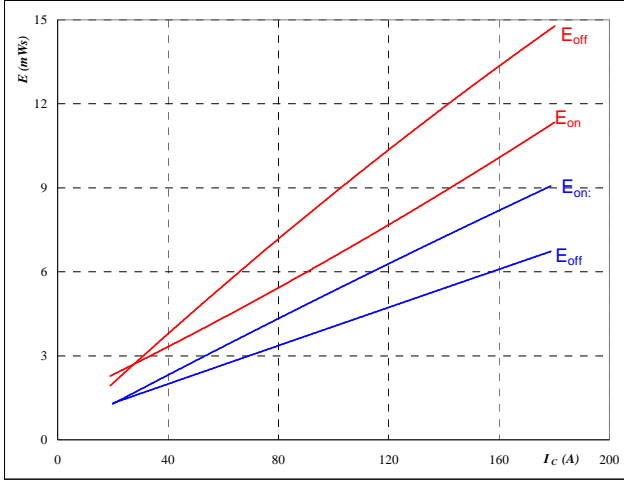

With an inductive load at

- T_j = 25/150 °C
- V_{CE} = 600 V
- V_{GE} = ±15 V
- R_{gon} = 4 Ω
- R_{goff} = 4 Ω

Figure 6 Output inverter IGBT

Typical switching energy losses
as a function of gate resistor

$E = f(R_G)$

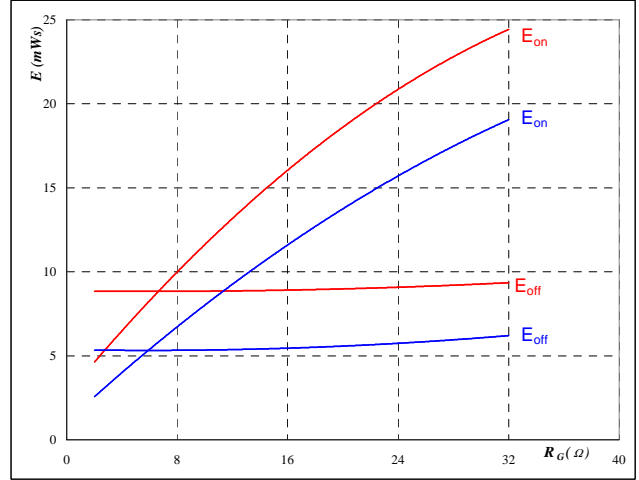

With an inductive load at

- T_j = 25/150 °C
- V_{CE} = 600 V
- V_{GE} = ±15 V
- I_C = 100 A

Figure 7 Output inverter IGBT

Typical reverse recovery energy loss
as a function of collector current

$E_{rec} = f(I_C)$

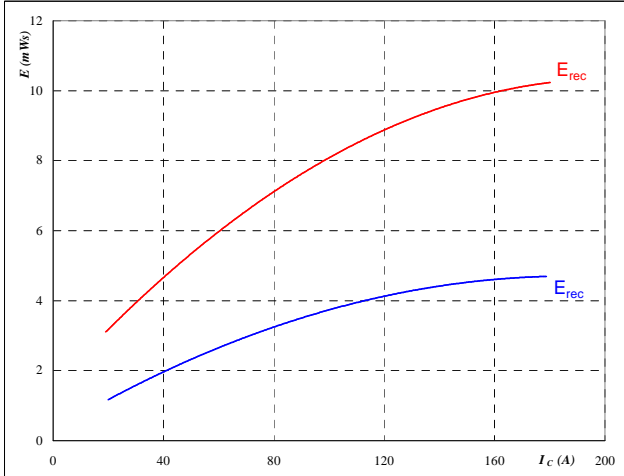

With an inductive load at

- T_j = 25/150 °C
- V_{CE} = 600 V
- V_{GE} = ±15 V
- R_{gon} = 4 Ω

Figure 8 Output inverter IGBT

Typical reverse recovery energy loss
as a function of gate resistor

$E_{rec} = f(R_G)$

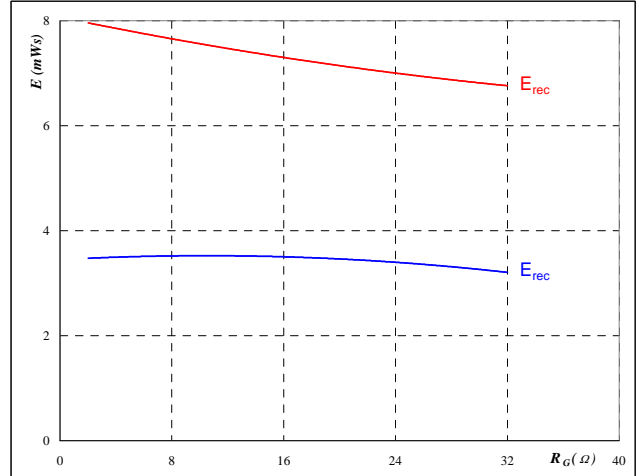

With an inductive load at

- T_j = 25/150 °C
- V_{CE} = 600 V
- V_{GE} = ±15 V
- I_C = 100 A



Output Inverter

Figure 9 Output inverter IGBT

Typical switching times as a function of collector current

$t = f(I_C)$

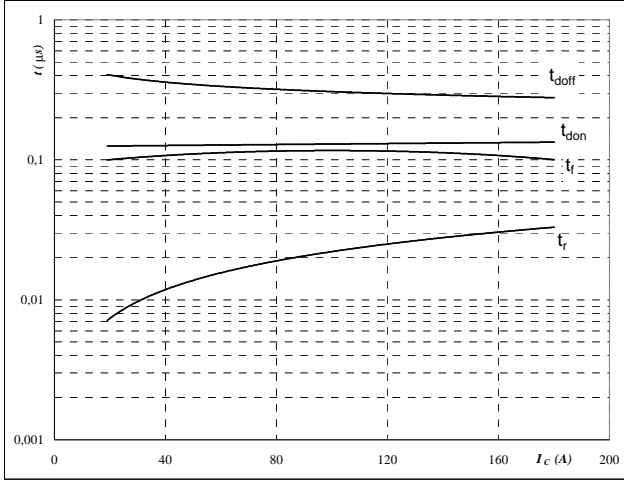

With an inductive load at

- $T_j = 150$ °C
- $V_{CE} = 600$ V
- $V_{GE} = \pm 15$ V
- $R_{gon} = 4$ Ω
- $R_{goff} = 4$ Ω

Figure 10 Output inverter IGBT

Typical switching times as a function of gate resistor

$t = f(R_G)$

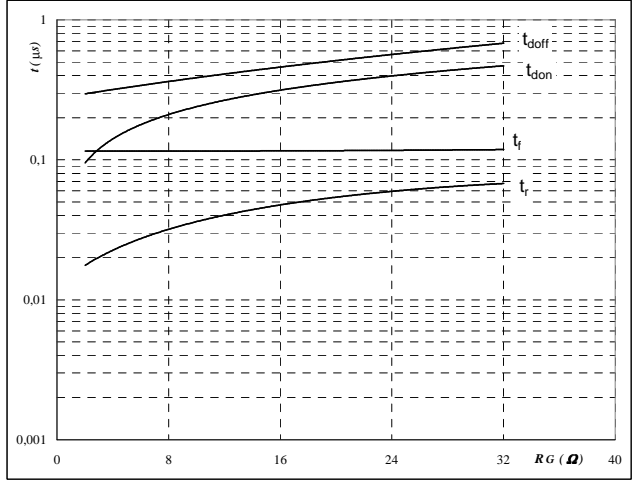

With an inductive load at

- $T_j = 150$ °C
- $V_{CE} = 600$ V
- $V_{GE} = \pm 15$ V
- $I_C = 100$ A

Figure 11 Output inverter FWD

Typical reverse recovery time as a function of collector current

$t_{rr} = f(I_C)$

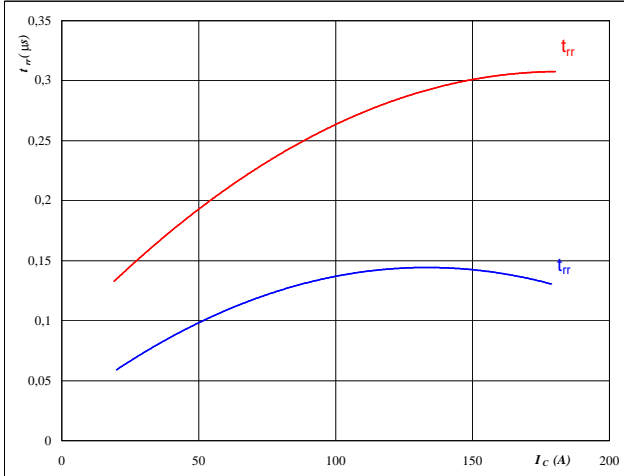

At

- $T_j = 25/150$ °C
- $V_{CE} = 600$ V
- $V_{GE} = \pm 15$ V
- $R_{gon} = 4$ Ω

Figure 12 Output inverter FWD

Typical reverse recovery time as a function of IGBT turn on gate resistor

$t_{rr} = f(R_{gon})$

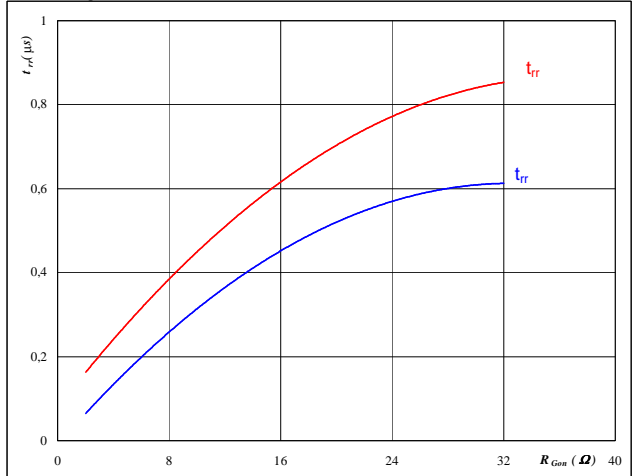

At

- $T_j = 25/150$ °C
- $V_R = 600$ V
- $I_F = 100$ A
- $V_{GE} = \pm 15$ V



Output Inverter

Figure 13 Output inverter FWD

Typical reverse recovery charge as a function of collector current

$Q_{rr} = f(I_c)$

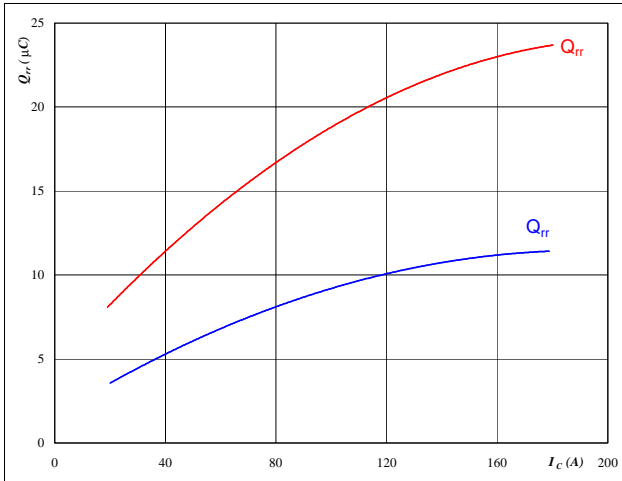

At
 $T_j = 25/150$ °C
 $V_{CE} = 600$ V
 $V_{GE} = \pm 15$ V
 $R_{gon} = 4$ Ω

Figure 14 Output inverter FWD

Typical reverse recovery charge as a function of IGBT turn on gate resistor

$Q_{rr} = f(R_{gon})$

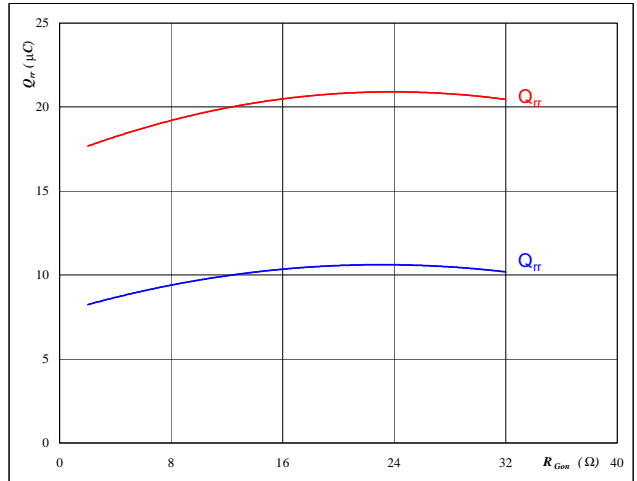

At
 $T_j = 25/150$ °C
 $V_R = 600$ V
 $I_F = 100$ A
 $V_{GE} = \pm 15$ V

Figure 15 Output inverter FWD

Typical reverse recovery current as a function of collector current

$I_{RRM} = f(I_c)$

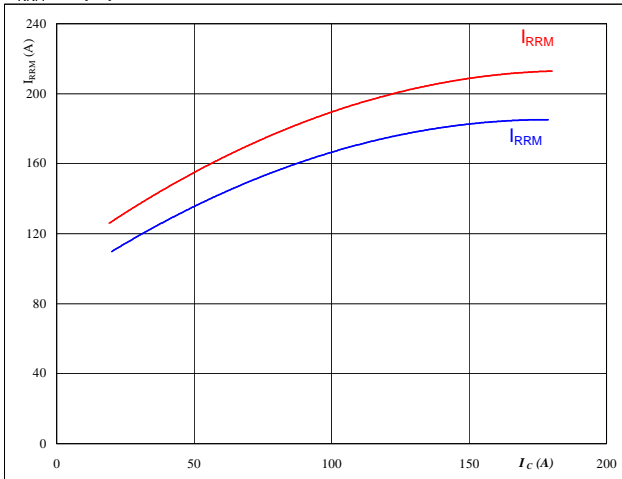

At
 $T_j = 25/150$ °C
 $V_{CE} = 600$ V
 $V_{GE} = \pm 15$ V
 $R_{gon} = 4$ Ω

Figure 16 Output inverter FWD

Typical reverse recovery current as a function of IGBT turn on gate resistor

$I_{RRM} = f(R_{gon})$

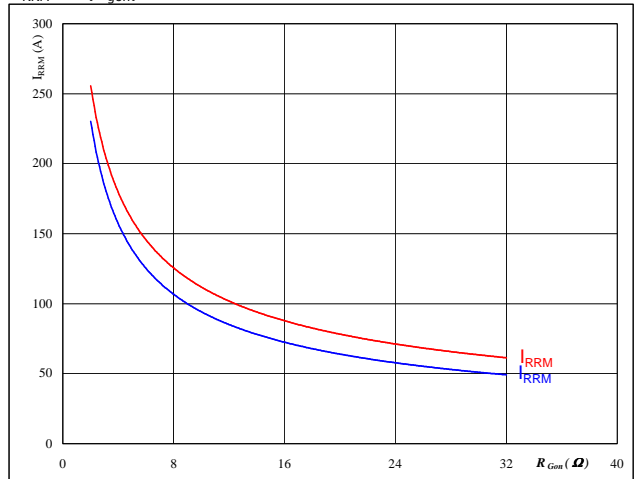

At
 $T_j = 25/150$ °C
 $V_R = 600$ V
 $I_F = 100$ A
 $V_{GE} = \pm 15$ V



Output Inverter

Figure 17 Output inverter FWD

Typical rate of fall of forward and reverse recovery current as a function of collector current

$$dI_0/dt, dI_{rec}/dt = f(I_C)$$

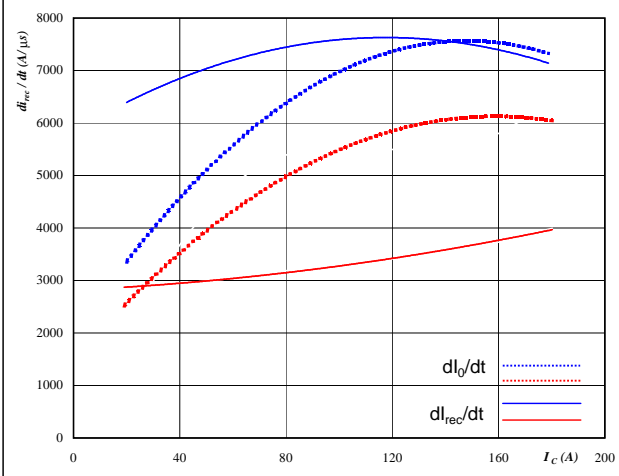

At
 $T_j = 25/150$ °C
 $V_{CE} = 600$ V
 $V_{GE} = \pm 15$ V
 $R_{gon} = 4$ Ω

Figure 18 Output inverter FWD

Typical rate of fall of forward and reverse recovery current as a function of IGBT turn on gate resistor

$$dI_0/dt, dI_{rec}/dt = f(R_{gon})$$

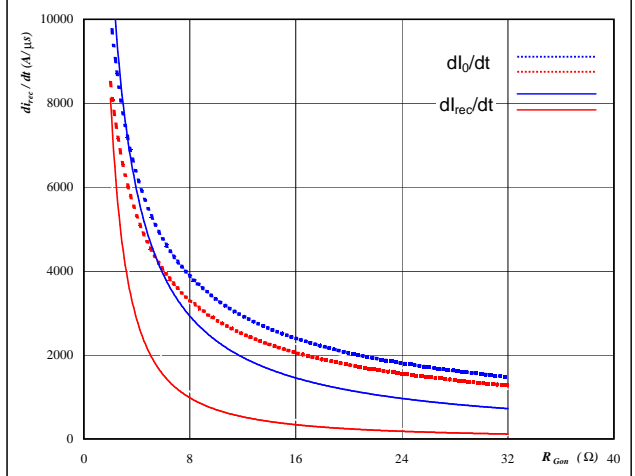

At
 $T_j = 25/150$ °C
 $V_R = 600$ V
 $I_F = 100$ A
 $V_{GE} = \pm 15$ V

Figure 19

IGBT transient thermal impedance as a function of pulse width

$$Z_{thJH} = f(tp)$$

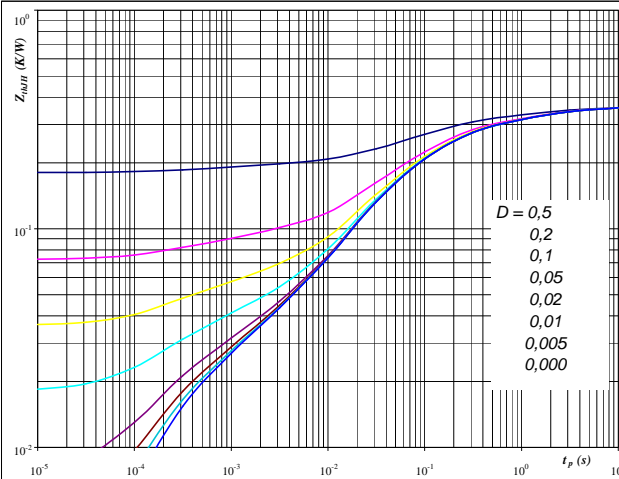

At
 $D = tp / T$
 $R_{thJH} = 0,36$ K/W $R_{thJH} = 0,44$ K/W
 Single device heated All devices heated
 IGBT thermal model values

R (K/W)	Tau (s)	R (K/W)	Tau (s)
0,03	5,4E+00	0,11	5,36
0,06	1,1E+00	0,06	1,05
0,14	1,4E-01	0,14	0,14
0,10	2,6E-02	0,10	0,03
0,02	1,7E-03	0,02	0,00
0,02	2,4E-04	0,02	0,00

Figure 20

FWD transient thermal impedance as a function of pulse width

$$Z_{thJH} = f(tp)$$

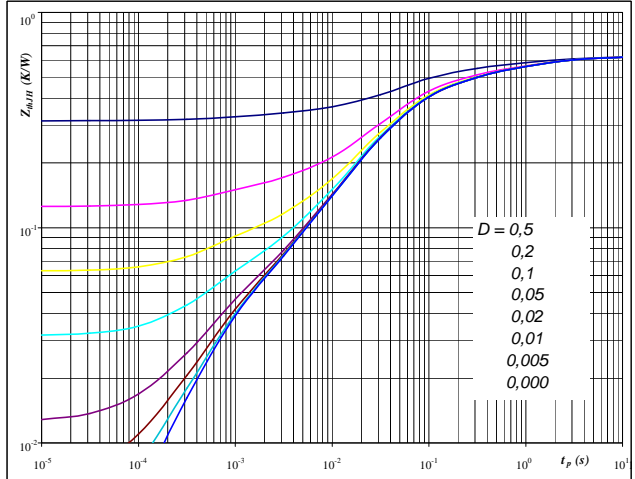

At
 $D = tp / T$
 $R_{thJH} = 0,63$ K/W $R_{thJH} = 0,63$ K/W
 Single device heated All devices heated
 FWD thermal model values

R (K/W)	Tau (s)	R (K/W)	Tau (s)
0,02	9,9E+00	0,02	9,88
0,09	1,4E+00	0,09	1,39
0,13	2,3E-01	0,13	0,23
0,27	4,5E-02	0,27	0,04
0,07	1,1E-02	0,07	0,01
0,04	7,6E-04	0,04	0,00



Output Inverter

Figure 21 Output inverter IGBT

Power dissipation as a function of heatsink temperature

$$P_{tot} = f(T_h)$$

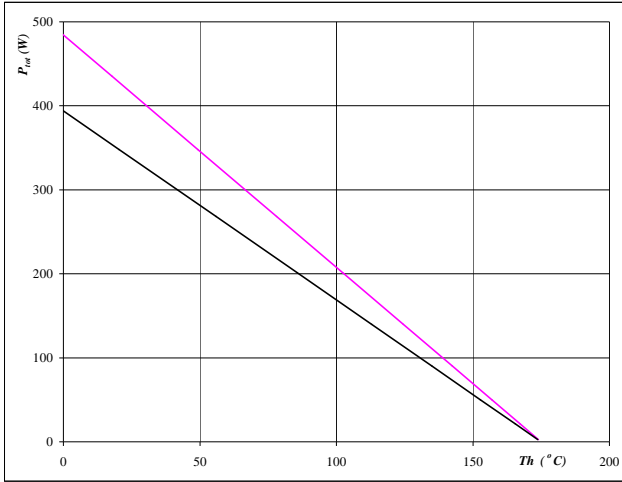

At
T_j = 175 °C
— single heating
— overall heating

Figure 22 Output inverter IGBT

Collector current as a function of heatsink temperature

$$I_C = f(T_h)$$

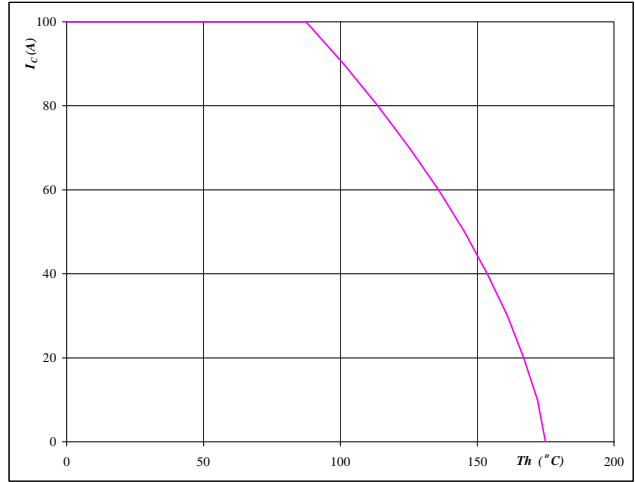

At
T_j = 175 °C
V_{GE} = 15 V

Figure 23 Output inverter FWD

Power dissipation as a function of heatsink temperature

$$P_{tot} = f(T_h)$$



At
T_j = 175 °C

Figure 24 Output inverter FWD

Forward current as a function of heatsink temperature

$$I_F = f(T_h)$$

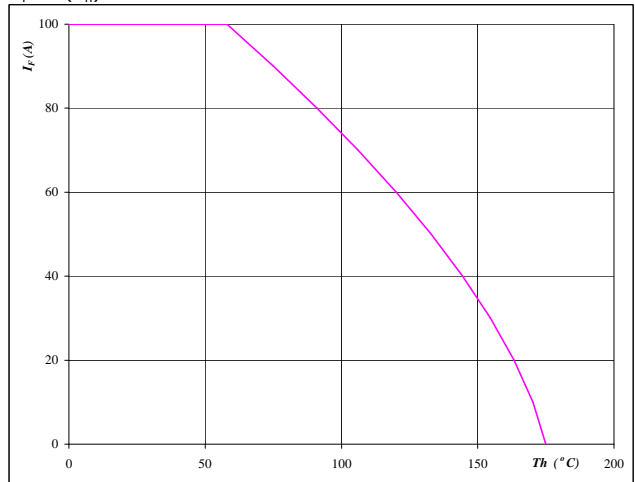

At
T_j = 175 °C



Output Inverter

Figure 25 Output inverter IGBT

Safe operating area as a function of collector-emitter voltage

$I_C = f(V_{CE})$

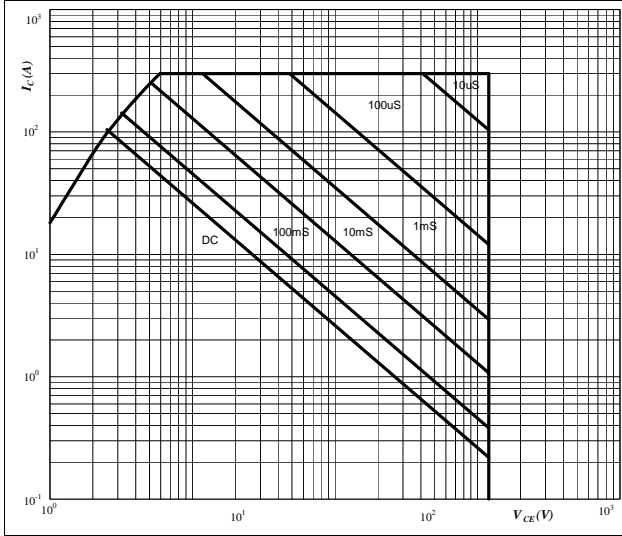

- At**
- D = single pulse
 - Th = 80 °C
 - $V_{GE} = \pm 15$ V
 - Tj = T_{jmax} °C

Figure 26 Output inverter IGBT

Gate voltage vs Gate charge

$V_{GE} = f(Q_g)$

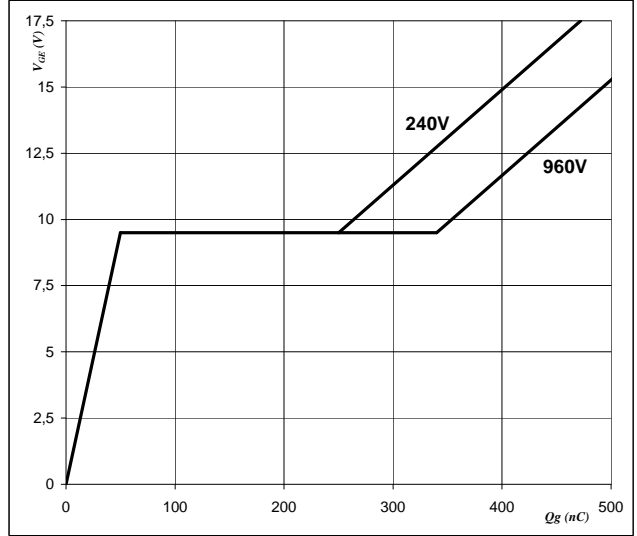

- At**
- $I_C = 100$ A



Brake

Figure 1 Brake IGBT

Typical output characteristics

$I_C = f(V_{CE})$

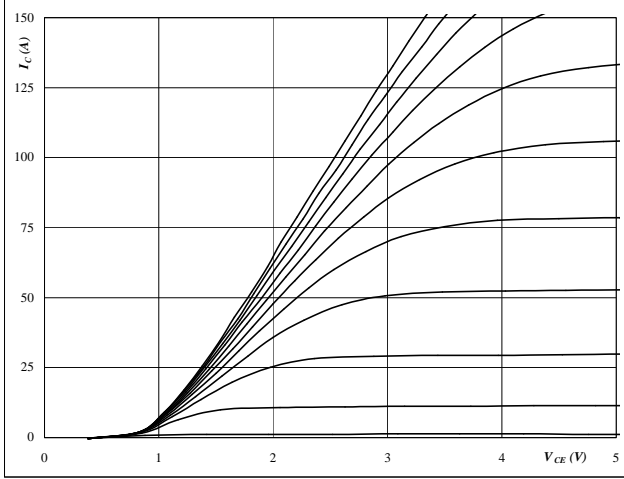

At
 $t_p = 250 \mu s$
 $T_j = 25 \text{ } ^\circ C$
V_{GE} from 7 V to 17 V in steps of 1 V

Figure 2 Brake IGBT

Typical output characteristics

$I_C = f(V_{CE})$

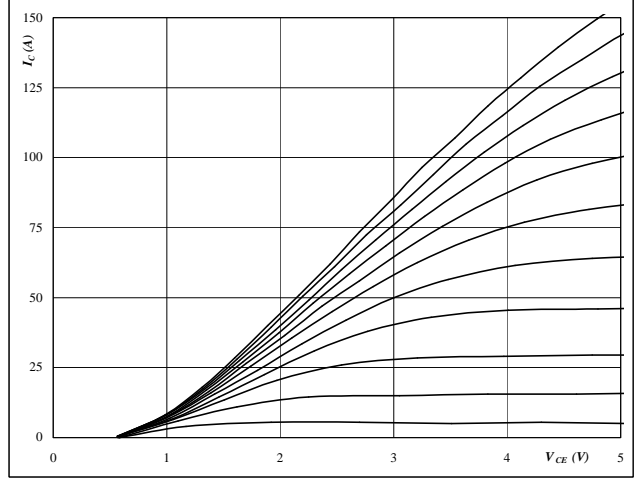

At
 $t_p = 250 \mu s$
 $T_j = 150 \text{ } ^\circ C$
V_{GE} from 7 V to 17 V in steps of 1 V

Figure 3 Brake IGBT

Typical transfer characteristics

$I_C = f(V_{GE})$

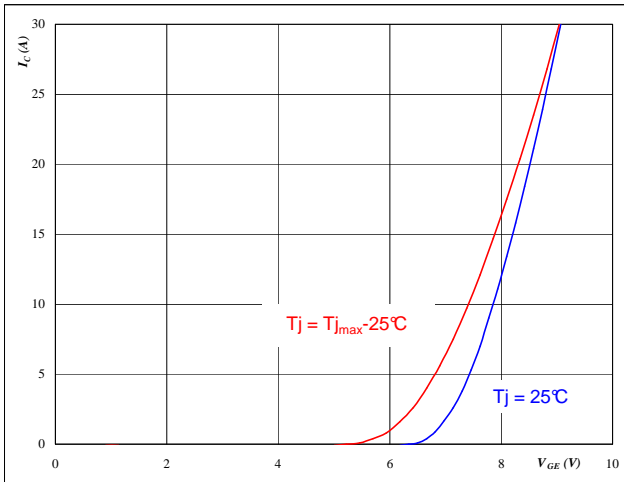

At
 $t_p = 250 \mu s$
 $V_{CE} = 10 V$

Figure 4 Brake FWD

Typical diode forward current as a function of forward voltage

$I_F = f(V_F)$

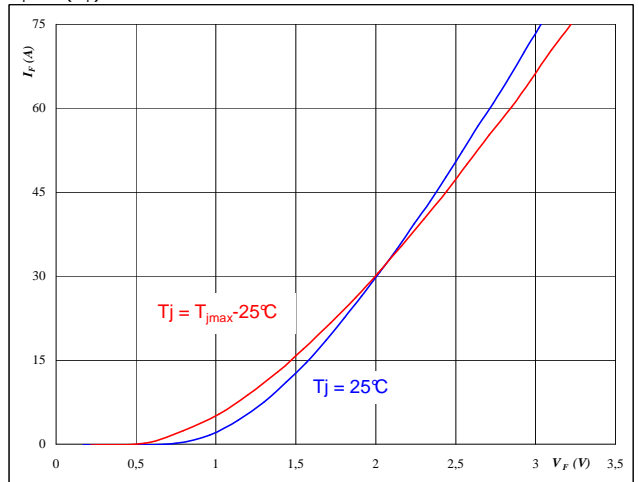

At
 $t_p = 250 \mu s$



Brake

Figure 5 Brake IGBT

Typical switching energy losses
as a function of collector current

$E = f(I_C)$

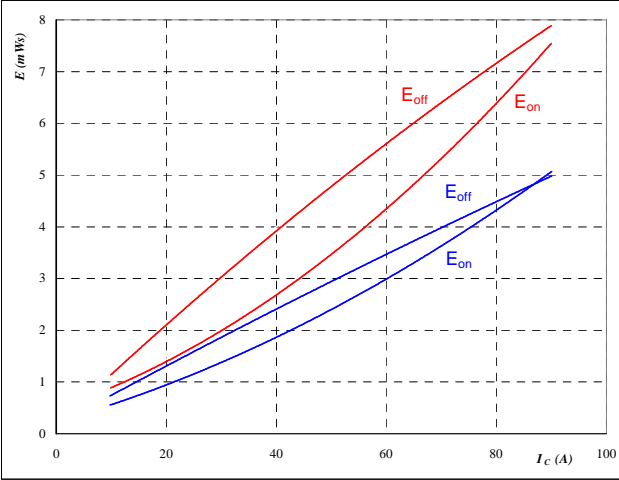

With an inductive load at

- $T_j = 25/150$ °C
- $V_{CE} = 600$ V
- $V_{GE} = \pm 15$ V
- $R_{gon} = 8$ Ω
- $R_{goff} = 8$ Ω

Figure 6 Brake IGBT

Typical switching energy losses
as a function of gate resistor

$E = f(R_G)$

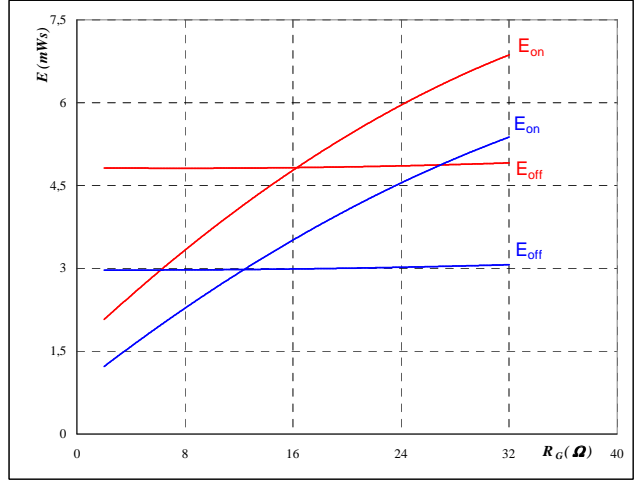

With an inductive load at

- $T_j = 25/150$ °C
- $V_{CE} = 600$ V
- $V_{GE} = \pm 15$ V
- $I_C = 50$ A

Figure 7 Brake IGBT

Typical reverse recovery energy loss
as a function of collector current

$E_{rec} = f(I_C)$

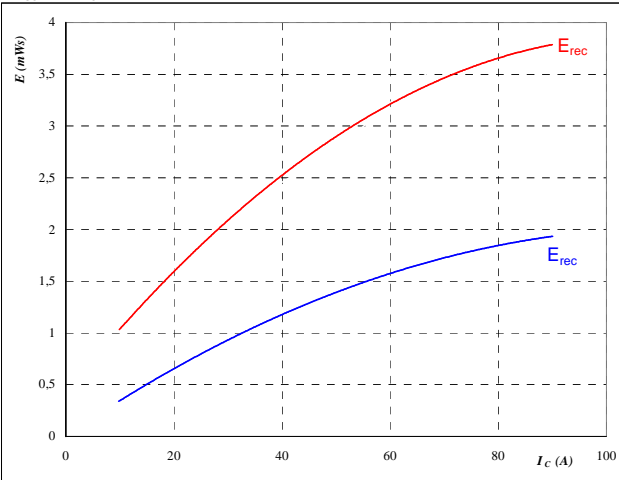

With an inductive load at

- $T_j = 25/150$ °C
- $V_{CE} = 600$ V
- $V_{GE} = \pm 15$ V
- $R_{gon} = 8$ Ω

Figure 8 Brake IGBT

Typical reverse recovery energy loss
as a function of gate resistor

$E_{rec} = f(R_G)$

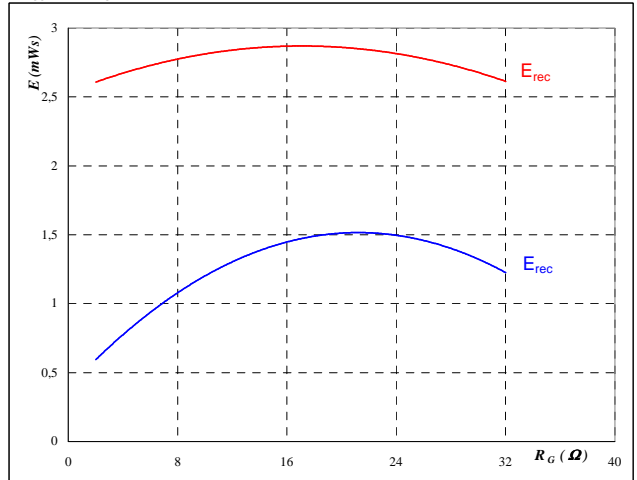

With an inductive load at

- $T_j = 25/150$ °C
- $V_{CE} = 600$ V
- $V_{GE} = \pm 15$ V
- $I_C = 50$ A



Brake

Figure 9 Brake IGBT

Typical switching times as a function of collector current

$t = f(I_C)$

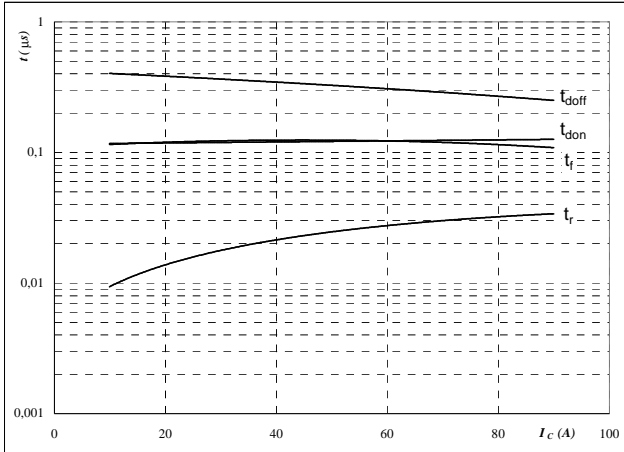

With an inductive load at

- $T_j = 150 \text{ } ^\circ\text{C}$
- $V_{CE} = 600 \text{ V}$
- $V_{GE} = \pm 15 \text{ V}$
- $R_{gon} = 8 \text{ } \Omega$
- $R_{goff} = 8 \text{ } \Omega$

Figure 10 Brake IGBT

Typical switching times as a function of gate resistor

$t = f(R_G)$

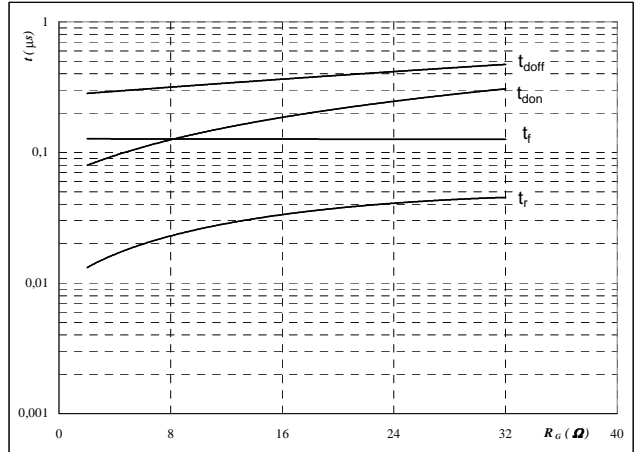

With an inductive load at

- $T_j = 150 \text{ } ^\circ\text{C}$
- $V_{CE} = 600 \text{ V}$
- $V_{GE} = \pm 15 \text{ V}$
- $I_C = 50 \text{ A}$

Figure 11 Brake IGBT

IGBT transient thermal impedance as a function of pulse width

$Z_{thJH} = f(t_p)$

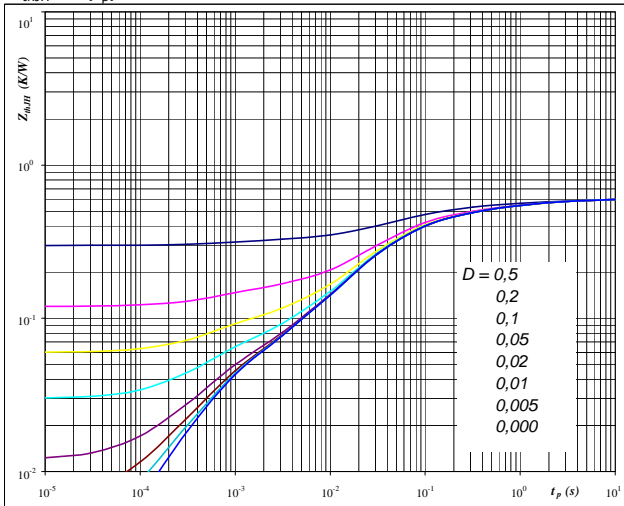

- At**
- $D = t_p / T$
 - $R_{thJH} = 0,60 \text{ K/W}$

Figure 12 Brake FWD

FWD transient thermal impedance as a function of pulse width

$Z_{thJH} = f(t_p)$

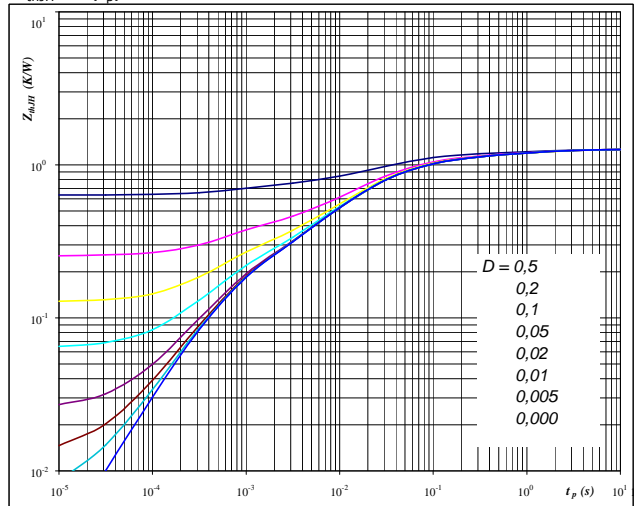

- At**
- $D = t_p / T$
 - $R_{thJH} = 1,27 \text{ K/W}$



Brake

Figure 13 Brake IGBT

Power dissipation as a function of heatsink temperature

$P_{tot} = f(T_h)$

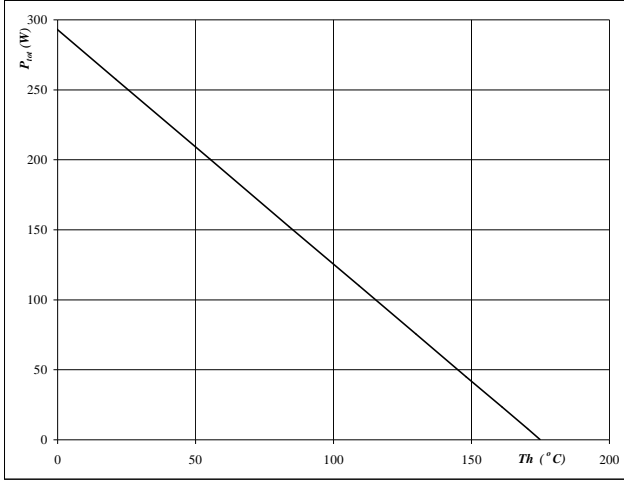

At
 $T_j = 175$ °C

Figure 14 Brake IGBT

Collector current as a function of heatsink temperature

$I_C = f(T_h)$

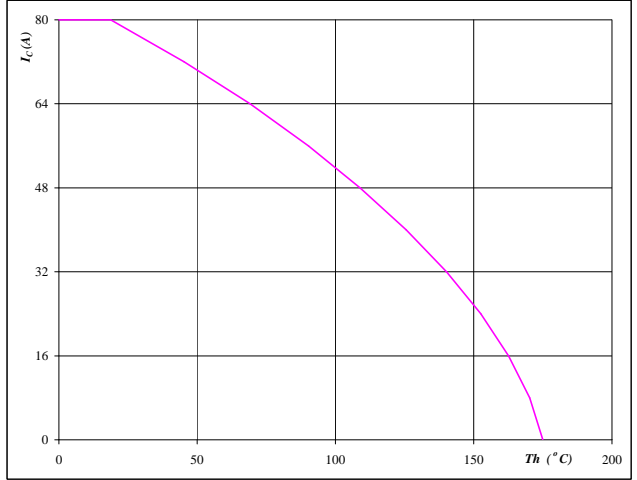

At
 $T_j = 175$ °C
 $V_{GE} = 15$ V

Figure 15 Brake FWD

Power dissipation as a function of heatsink temperature

$P_{tot} = f(T_h)$

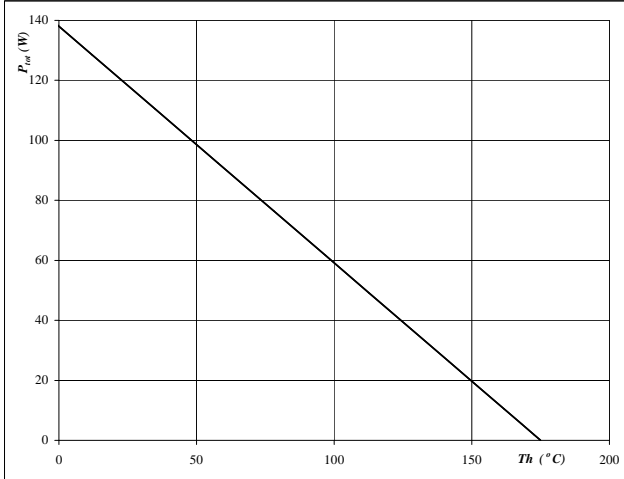

At
 $T_j = 175$ °C

Figure 16 Brake FWD

Forward current as a function of heatsink temperature

$I_F = f(T_h)$

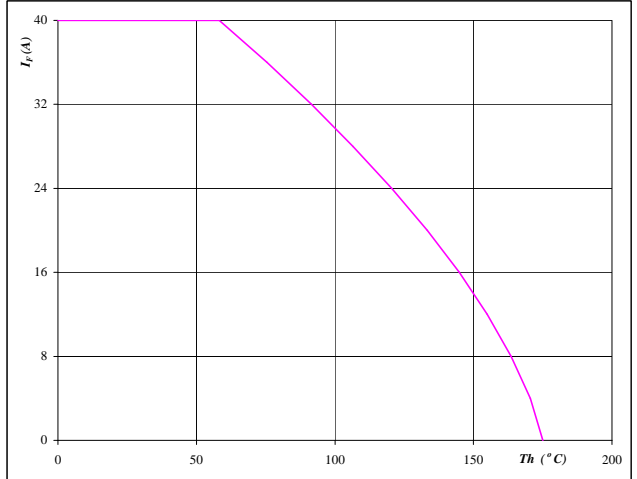

At
 $T_j = 175$ °C



Brake Inverse Diode

Figure 1 Brake inverse diode

Typical diode forward current as a function of forward voltage

$I_F = f(V_F)$

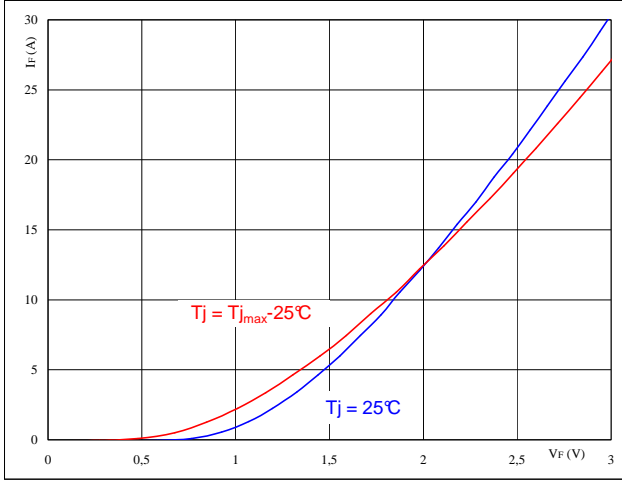

At
 $t_p = 250 \mu\text{s}$

Figure 2 Brake inverse diode

Diode transient thermal impedance as a function of pulse width

$Z_{thJH} = f(t_p)$

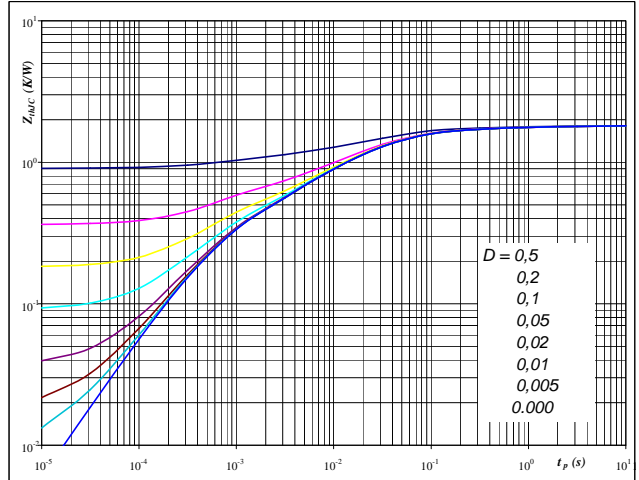

At
 $D = t_p / T$
 $R_{thJH} = 1,81 \text{ K/W}$

Figure 3 Brake inverse diode

Power dissipation as a function of heatsink temperature

$P_{tot} = f(T_h)$

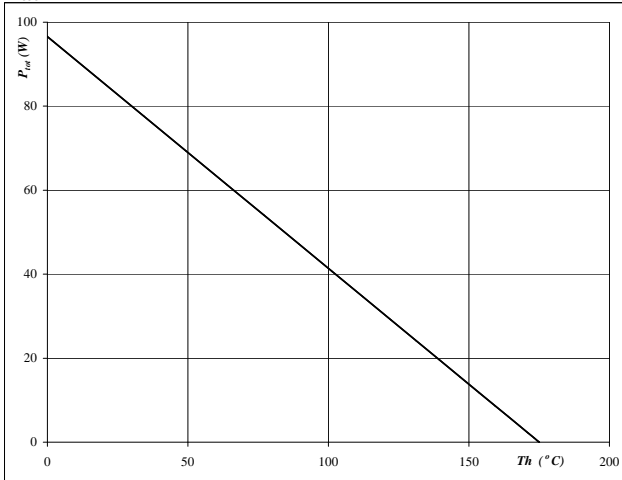

At
 $T_j = 175 \text{ }^\circ\text{C}$

Figure 4 Brake inverse diode

Forward current as a function of heatsink temperature

$I_F = f(T_h)$

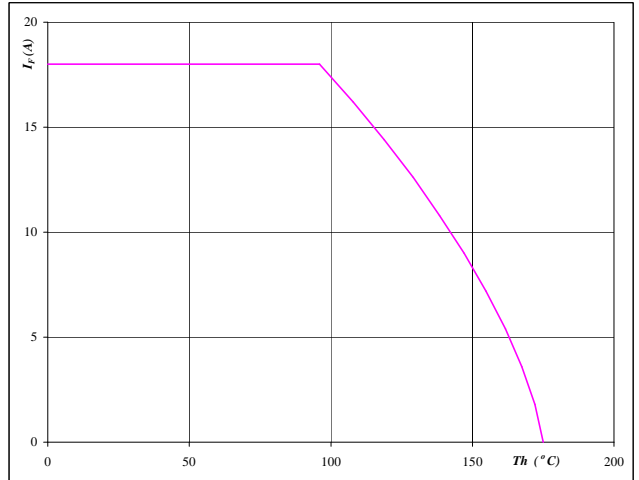

At
 $T_j = 175 \text{ }^\circ\text{C}$



Input Rectifier Bridge

Figure 1 Rectifier diode

Typical diode forward current as a function of forward voltage

$I_F = f(V_F)$

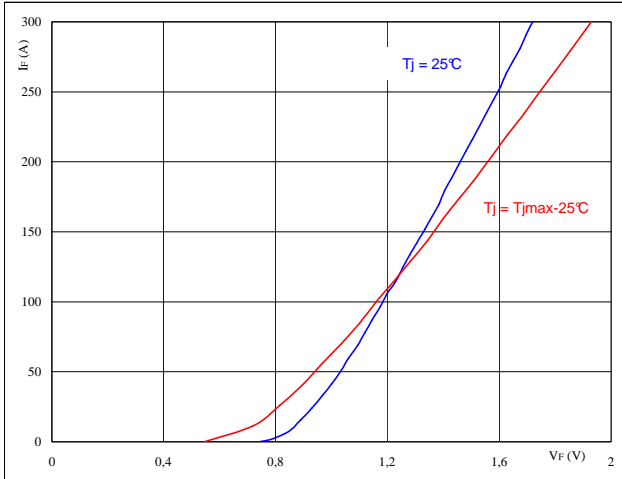

At
 $t_p = 250 \mu s$

Figure 2 Rectifier diode

Diode transient thermal impedance as a function of pulse width

$Z_{thJH} = f(t_p)$

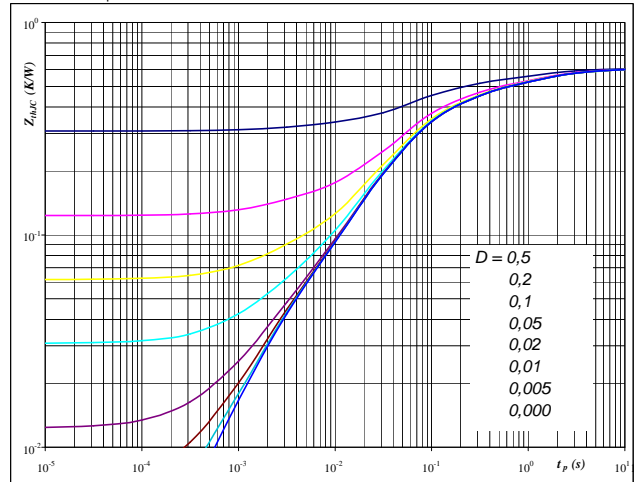

At
 $D = t_p / T$
 $R_{thJH} = 0,62 \text{ K/W}$

Figure 3 Rectifier diode

Power dissipation as a function of heatsink temperature

$P_{tot} = f(T_h)$

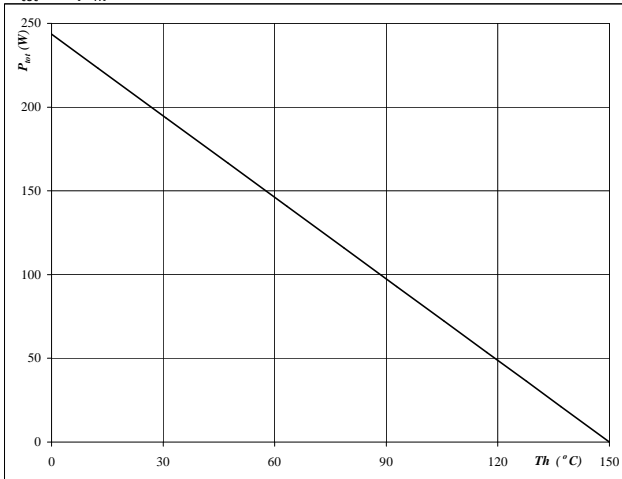

At
 $T_j = 150 \text{ °C}$

Figure 4 Rectifier diode

Forward current as a function of heatsink temperature

$I_F = f(T_h)$

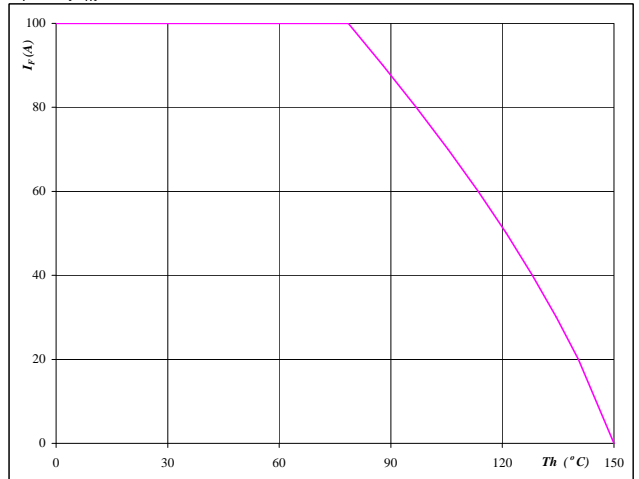

At
 $T_j = 150 \text{ °C}$



Thermistor

Figure 1 Thermistor

Typical NTC characteristic
as a function of temperature

$$R_T = f(T)$$

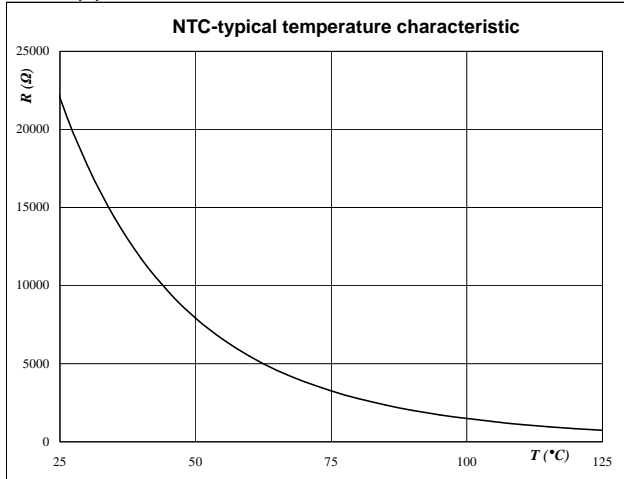



Switching Definitions Output Inverter

General conditions

T_j	=	150 °C
R_{gon}	=	8 Ω
R_{goff}	=	8 Ω

Figure 1 Output inverter IGBT

Turn-off Switching Waveforms & definition of t_{doff} , t_{Eoff}
(t_{Eoff} = integrating time for E_{off})

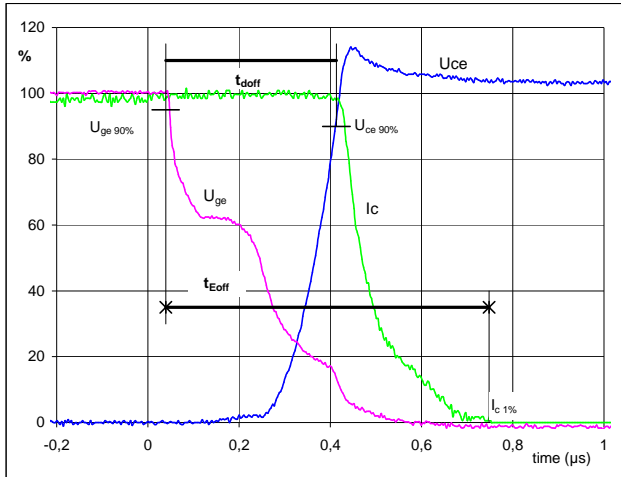

$V_{GE}(0\%)$	=	-15	V
$V_{GE}(100\%)$	=	15	V
$V_C(100\%)$	=	600	V
$I_C(100\%)$	=	100	A
t_{doff}	=	0,36	μ s
t_{Eoff}	=	0,71	μ s

Figure 2 Output inverter IGBT

Turn-on Switching Waveforms & definition of t_{don} , t_{Eon}
(t_{Eon} = integrating time for E_{on})

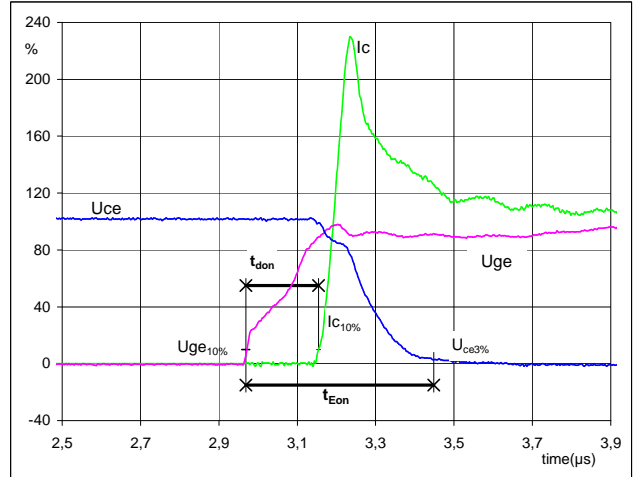

$V_{GE}(0\%)$	=	-15	V
$V_{GE}(100\%)$	=	15	V
$V_C(100\%)$	=	600	V
$I_C(100\%)$	=	100	A
t_{don}	=	0,18	μ s
t_{Eon}	=	0,48	μ s

Figure 3 Output inverter IGBT

Turn-off Switching Waveforms & definition of t_r

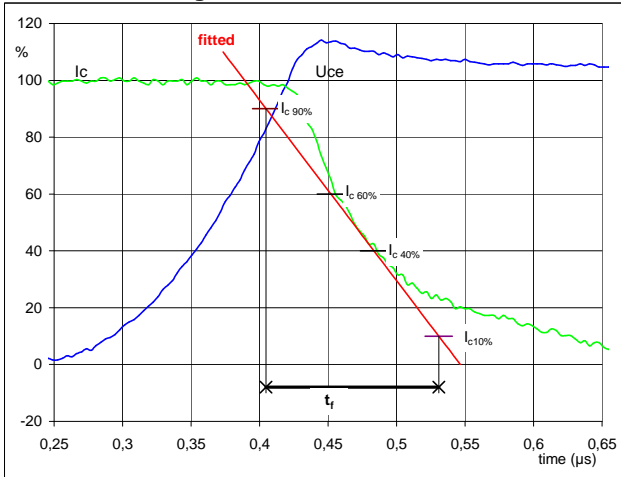

$V_C(100\%)$	=	600	V
$I_C(100\%)$	=	100	A
t_r	=	0,11	μ s

Figure 4 Output inverter IGBT

Turn-on Switching Waveforms & definition of t_r

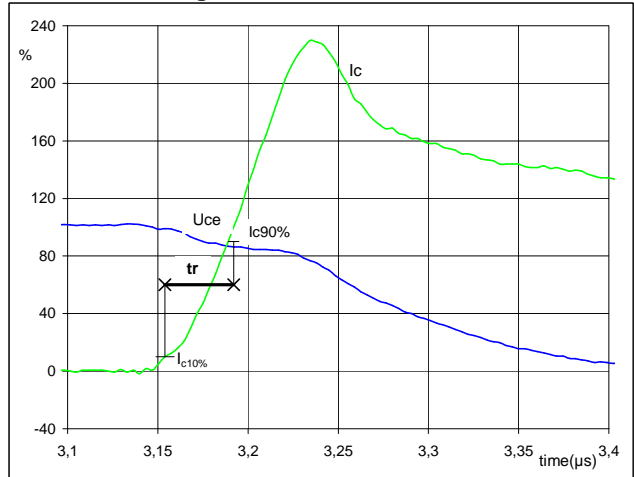

$V_C(100\%)$	=	600	V
$I_C(100\%)$	=	100	A
t_r	=	0,04	μ s



Switching Definitions Output Inverter

Figure 5 Output inverter IGBT
Turn-off Switching Waveforms & definition of t_{Eoff}

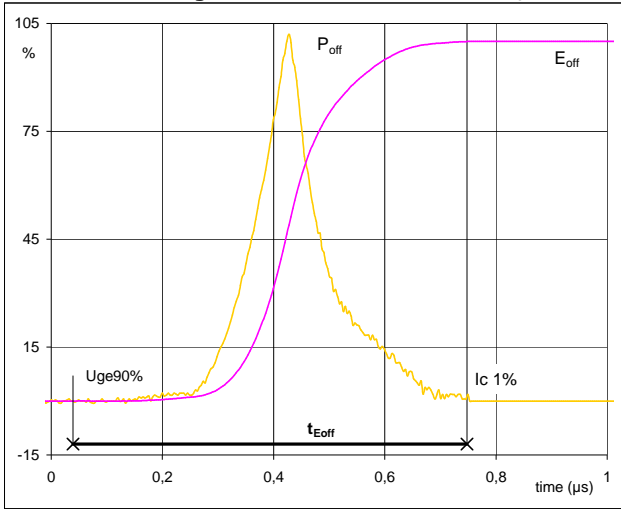

$P_{off} (100\%) =$	59,90	kW
$E_{off} (100\%) =$	8,77	mJ
$t_{Eoff} =$	0,71	μs

Figure 6 Output inverter IGBT
Turn-on Switching Waveforms & definition of t_{Eon}

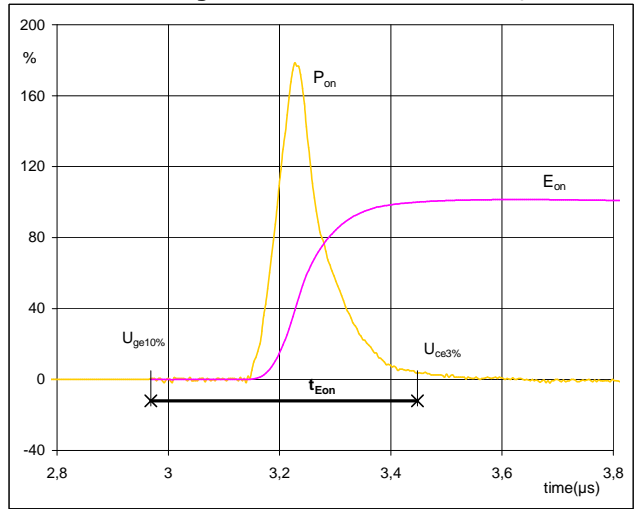

$P_{on} (100\%) =$	59,90	kW
$E_{on} (100\%) =$	10,51	mJ
$t_{Eon} =$	0,48	μs

Figure 7 Output inverter FWD
Turn-off Switching Waveforms & definition of t_{rr}

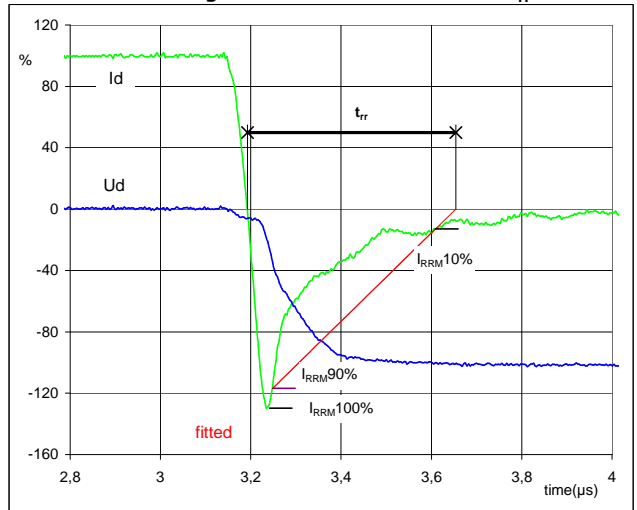

$V_d (100\%) =$	600	V
$I_d (100\%) =$	100	A
$I_{RRM} (100\%) =$	-129	A
$t_{rr} =$	0,34	μs



Switching Definitions Output Inverter

Figure 8 Output inverter FWD
Turn-on Switching Waveforms & definition of t_{Qrr}
(t_{Qrr} = integrating time for Q_{rr})

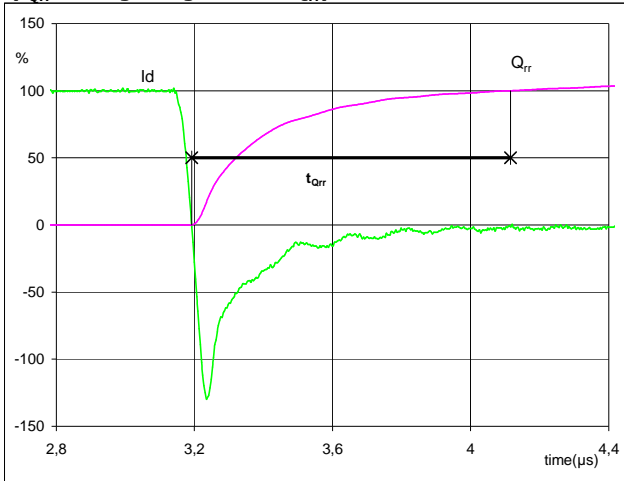

I_d (100%) =	100	A
Q_{rr} (100%) =	19,13	μC
t_{Qint} =	0,92	μs

Figure 9 Output inverter FWD
Turn-on Switching Waveforms & definition of t_{Erec}
(t_{Erec} = integrating time for E_{rec})

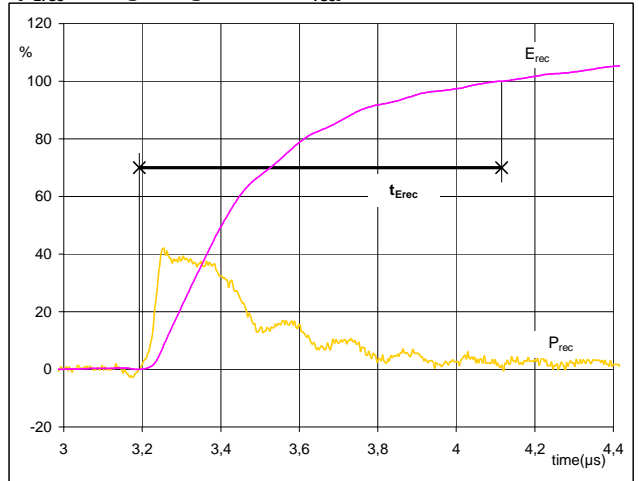

P_{rec} (100%) =	59,90	kW
E_{rec} (100%) =	7,39	mJ
t_{Erec} =	0,92	μs



Ordering Code and Marking - Outline - Pinout

Ordering Code & Marking

Version	Ordering Code	in DataMatrix as	in packaging barcode as
without thermal paste 12mm housing	V23990-P760-A-PM	P760-A	P760-A

Outline

Pin	Pin table						
	X	Y	Pin	Pin			
1	DC-	71,2	0	33	G	10,6	37,2
2	DC-	68,7	0	34	G	18,45	37,2
3	DC-	66,2	0	35	E	21,25	37,2
4	DC-	63,7	0	36	V	24,05	37,2
5	DC+	55,95	0	37	V	26,55	37,2
6	DC+	53,45	0	38	V	29,05	37,2
7	DC+	55,95	2,8	39	W	36,1	37,2
8	DC+	53,45	2,8	40	W	38,6	37,2
9	DC+	48,4	0	41	W	41,1	37,2
10	DC+	45,9	0	42	E	43,9	37,2
11	E	38,9	0	43	G	46,7	37,2
12	DC-	36,1	0	44	L1	53,7	37,2
13	G	38,9	2,8	45	L1	56,2	37,2
14	DC-	36,1	2,8	46	L1	58,7	37,2
15	DC-	31,3	0	47	L2	71,2	37,2
16	E	28,5	0	48	L2	71,2	34,7
17	DC-	31,3	2,8	49	L2	71,2	32,2
18	G	28,5	2,8	50	L3	71,2	25,2
19	R2	19,3	0	51	L3	71,2	22,7
20	R1	19,3	2,8	52	L3	71,2	20,2
21	DC+	12,3	0	53	BrC	71,2	12,8
22	DC+	9,8	0	54	BrC	68,7	12,8
23	DC+	12,3	2,8	55	BrG	71,2	5,6
24	DC+	9,8	2,8	56	BrE	71,2	2,8
25	E	2,8	0				
26	DC-	0	0				
27	G	2,8	2,8				
28	DC-	0	2,8				
29	U	0	37,2				
30	U	2,5	37,2				
31	U	5	37,2				
32	E	7,8	37,2				

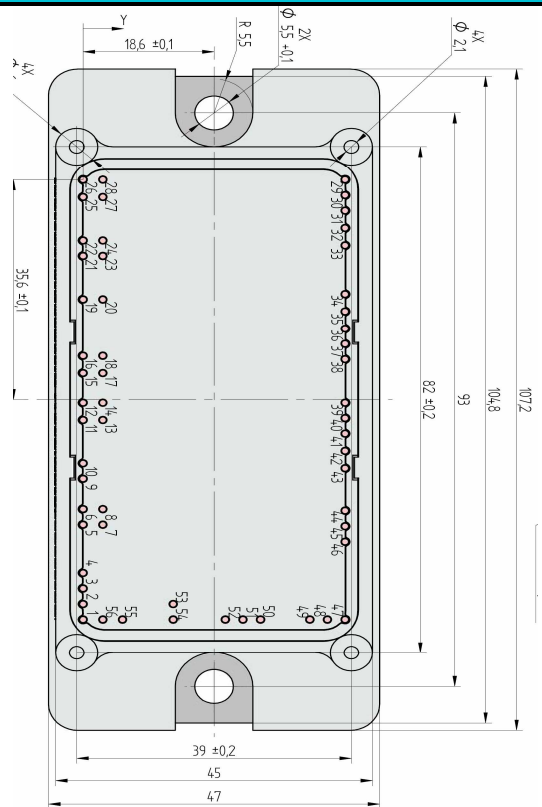

Pinout

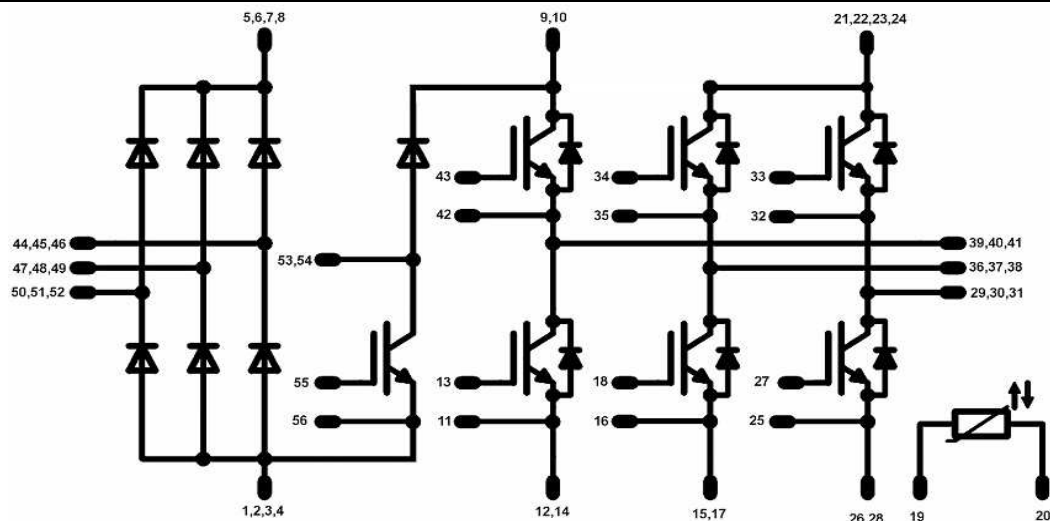



DISCLAIMER

The information given in this datasheet describes the type of component and does not represent assured characteristics. For tested values please contact Vincotech. Vincotech reserves the right to make changes without further notice to any products herein to improve reliability, function or design. Vincotech does not assume any liability arising out of the application or use of any product or circuit described herein; neither does it convey any license under its patent rights, nor the rights of others.

LIFE SUPPORT POLICY

Vincotech products are not authorised for use as critical components in life support devices or systems without the express written approval of Vincotech.

As used herein:

1. Life support devices or systems are devices or systems which, (a) are intended for surgical implant into the body, or (b) support or sustain life, or (c) whose failure to perform when properly used in accordance with instructions for use provided in labelling can be reasonably expected to result in significant injury to the user.
2. A critical component is any component of a life support device or system whose failure to perform can be reasonably expected to cause the failure of the life support device or system, or to affect its safety or effectiveness.