

IRF7807D2PbF

FETKY™ MOSFET / SCHOTTKY DIODE

- Co-Pack N-channel HEXFET® Power MOSFET and Schottky Diode
- Ideal for Synchronous Rectifiers in DC-DC Converters up to 5A Output
- Low Conduction Losses
- Low Switching Losses
- Low Vf Schottky Rectifier
- Lead-Free

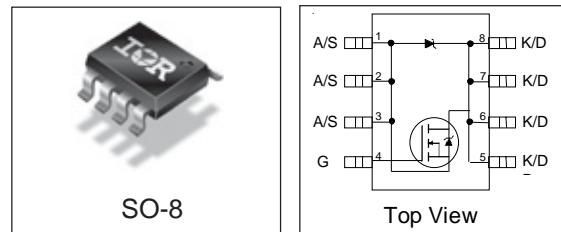

Description

The FETKY™ family of Co-Pack HEXFET® MOSFETs and Schottky diodes offers the designer an innovative, board space saving solution for switching regulator and power management applications. HEXFET power MOSFETs utilize advanced processing techniques to achieve extremely low on-resistance per silicon area. Combining this technology with International Rectifier's low forward drop Schottky rectifiers results in an extremely efficient device suitable for use in a wide variety of portable electronics applications.

The SO-8 has been modified through a customized leadframe for enhanced thermal characteristics. The SO-8 package is designed for vapor phase, infrared or wave soldering techniques.

Device Features (Max Values)

	IRF7807D2
V_{DS}	30V
$R_{DS(on)}$	25mΩ
Q_g	14nC
Q_{SW}	5.2nC
Q_{OSS}	21.6nC

Absolute Maximum Ratings

Parameter	Symbol	Max.	Units
Drain-Source Voltage	V_{DS}	30	V
Gate-Source Voltage	V_{GS}	±12	
Continuous Drain or Source Current ($V_{GS} \geq 4.5V$)	I_D	25°C	8.3
		70°C	6.6
Pulsed Drain Current ^①	I_{DM}	66	A
Power Dissipation	P_D	25°C	2.5
		70°C	1.6
Schottky and Body Diode	$I_F (AV)$	25°C	3.7
Average Forward Current ^②		70°C	2.3
Junction & Storage Temperature Range	T_J, T_{STG}	-55 to 150	°C

Thermal Resistance

Parameter	Symbol	Max.	Units
Maximum Junction-to-Ambient ^③	$R_{\theta JA}$	50	°C/W

www.irf.com

1
10/7/04

Electrical Characteristics

Parameter		Min	Typ	Max	Units	Conditions
Drain-to-Source Breakdown Voltage*	$V_{(BR)DSS}$	30			V	$V_{GS} = 0V, I_D = 250\mu A$
Static Drain-Source on Resistance*	$R_{DS(on)}$		17	25	m Ω	$V_{GS} = 4.5V, I_D = 7A$ ②
Gate Threshold Voltage*	$V_{GS(th)}$	1.0			V	$V_{DS} = V_{GS}, I_D = 250\mu A$
Drain-Source Leakage Current*	I_{DSS}			90	μA	$V_{DS} = 24V, V_{GS} = 0V$
				7.2	mA	$V_{DS} = 24V, V_{GS} = 0V, T_j = 125^\circ C$
Gate-Source Leakage Current*	I_{GSS}			+/- 100	nA	$V_{GS} = +/-12V$
Total Gate Charge Synch FET*	Q_{gsync}		10.5	14	nC	$V_{DS} < 100mV, V_{GS} = 5V, I_D = 7A$
Total Gate Charge Control FET*	Q_{gcont}		12	17		$V_{DS} = 16V, V_{GS} = 5V, I_D = 7A$
Pre-Vth Gate-Source Charge	Q_{gs1}		2.1			$V_{DS} = 16V, I_D = 7A$
Post-Vth Gate-Source Charge	Q_{gs2}		0.76			
Gate to Drain Charge	Q_{gd}		2.9			
Switch Charge* ($Q_{gs2} + Q_{gd}$)	Q_{SW}		3.66	5.2		
Output Charge*	Q_{oss}		17.6	21.6		$V_{DS} = 16V, V_{GS} = 0$
Gate Resistance	R_g		1.2			Ω

Schottky Diode & Body Diode Ratings and Characteristics

Parameter		Min	Typ	Max	Units	Conditions
Diode Forward Voltage	V_{SD}			0.54	V	$T_j = 25^\circ C, I_s = 3A, V_{GS} = 0V$ ②
				0.43		$T_j = 125^\circ C, I_s = 3A, V_{GS} = 0V$ ②
Reverse Recovery Time	t_{rr}		36		ns	$T_j = 25^\circ C, I_s = 7.0A, V_{DS} = 16V$
Reverse Recovery Charge	Q_{rr}		41		nC	$di/dt = 100A/\mu s$
Forward Turn-On Time	t_{on}	Intrinsic turn-on time is negligible (turn-on is dominated by $L_s + L_D$)				

- ① Repetitive rating; pulse width limited by max. junction temperature.
 ② Pulse width $\leq 300 \mu s$; duty cycle $\leq 2\%$.
 ③ When mounted on 1 inch square copper board, $t < 10$ sec.
 ④ 50% Duty Cycle, Rectangular
 * Devices are 100% tested to these parameters.

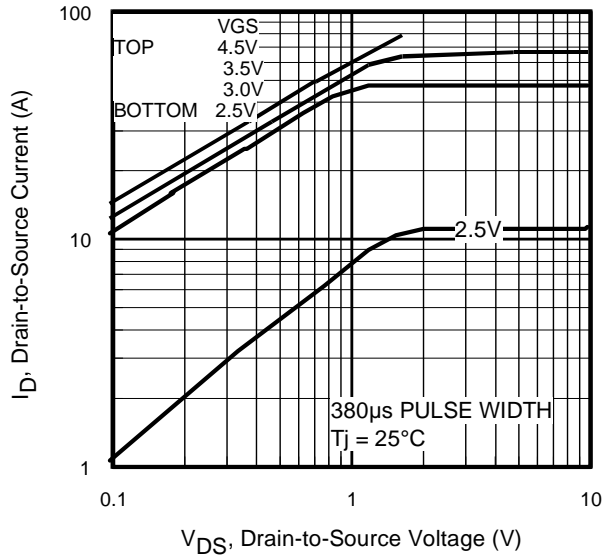

Fig 1. Typical Output Characteristics

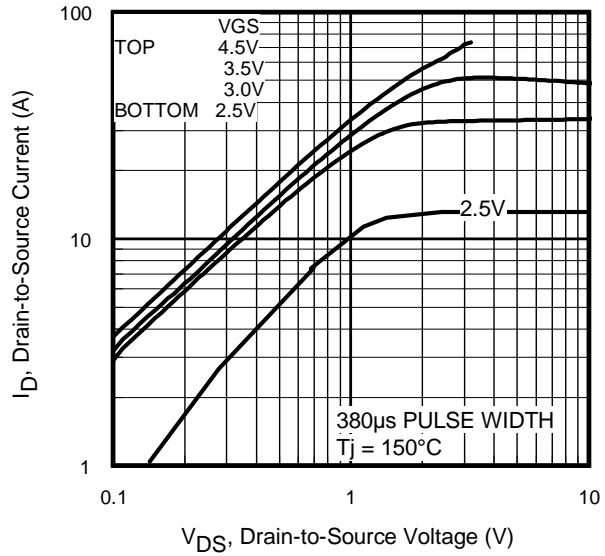

Fig 2. Typical Output Characteristics

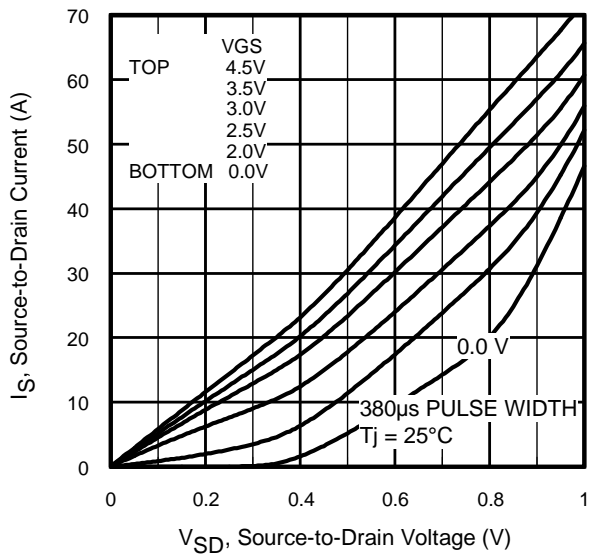

Fig 3. Typical Reverse Output Characteristics

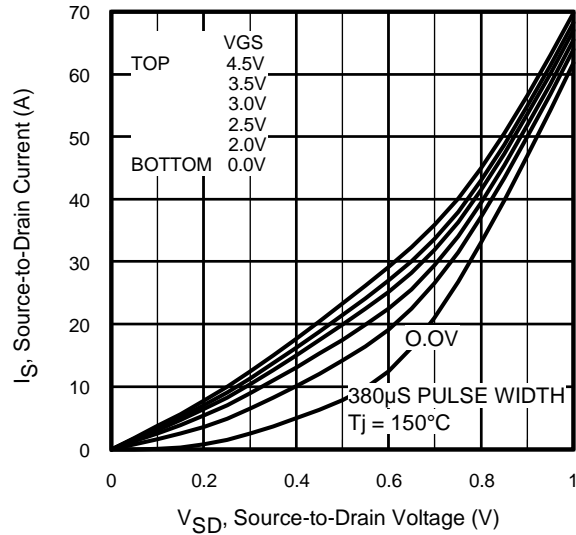

Fig 4. Typical Reverse Output Characteristics

IRF7807D2PbF

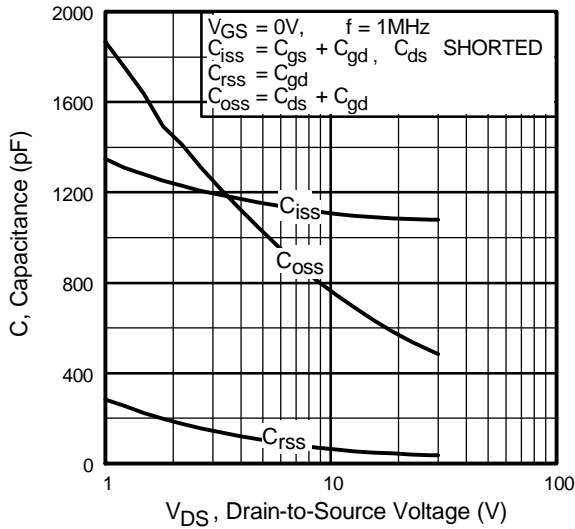

Fig 5. Typical Capacitance Vs. Drain-to-Source Voltage

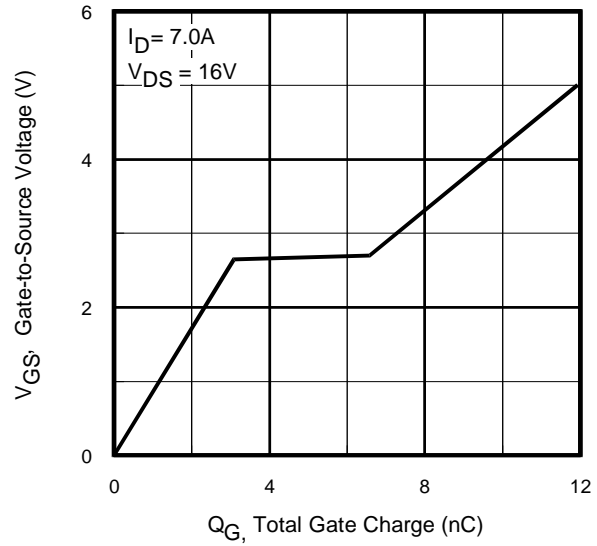

Fig 6. Typical Gate Charge Vs. Gate-to-Source Voltage

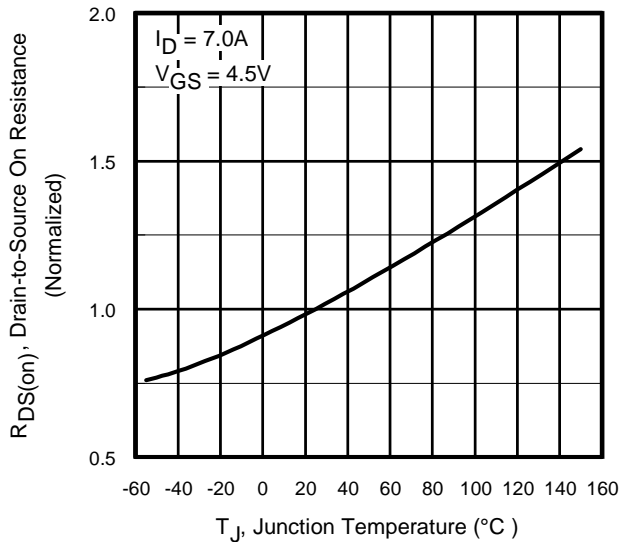

Fig 7. Normalized On-Resistance Vs. Temperature

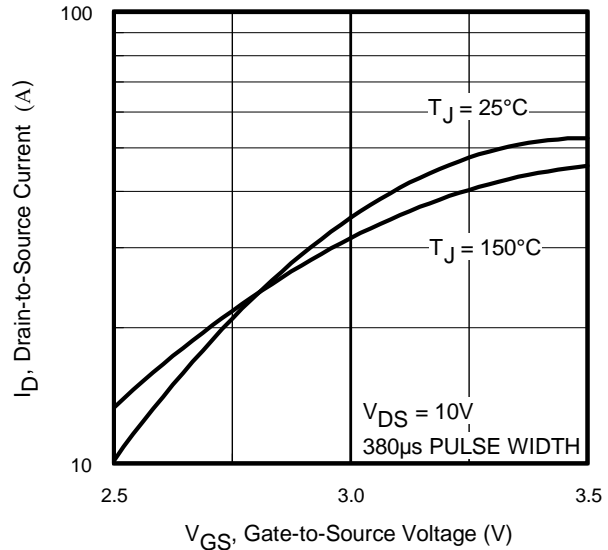

Fig 8. Typical Transfer Characteristics

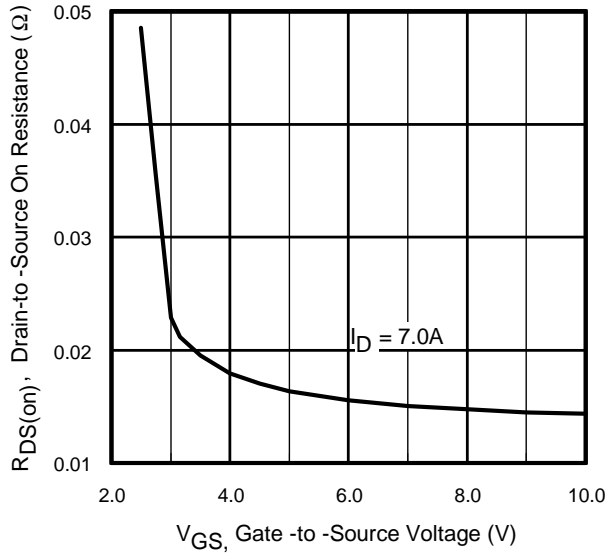

Fig 9. On-Resistance Vs. Gate Voltage

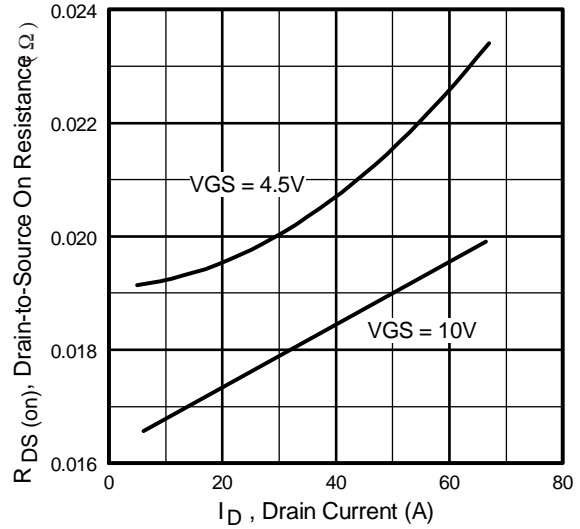

Fig 10. On-Resistance Vs. Drain Current

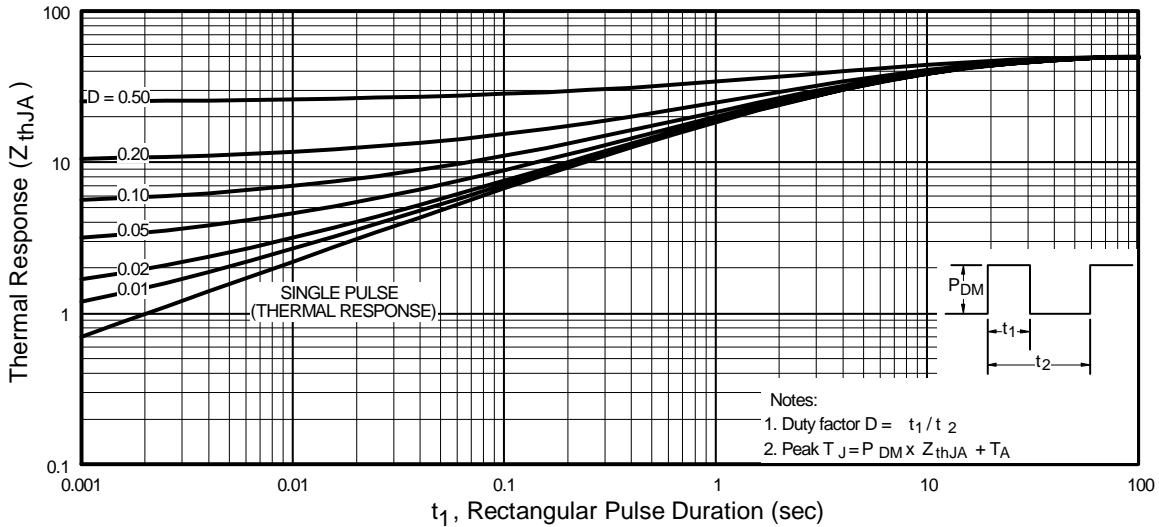

Fig 11. Maximum Effective Transient Thermal Impedance, Junction-to-Ambient (MOSFET)

Mosfet, Body Diode & Schottky Diode Characteristics

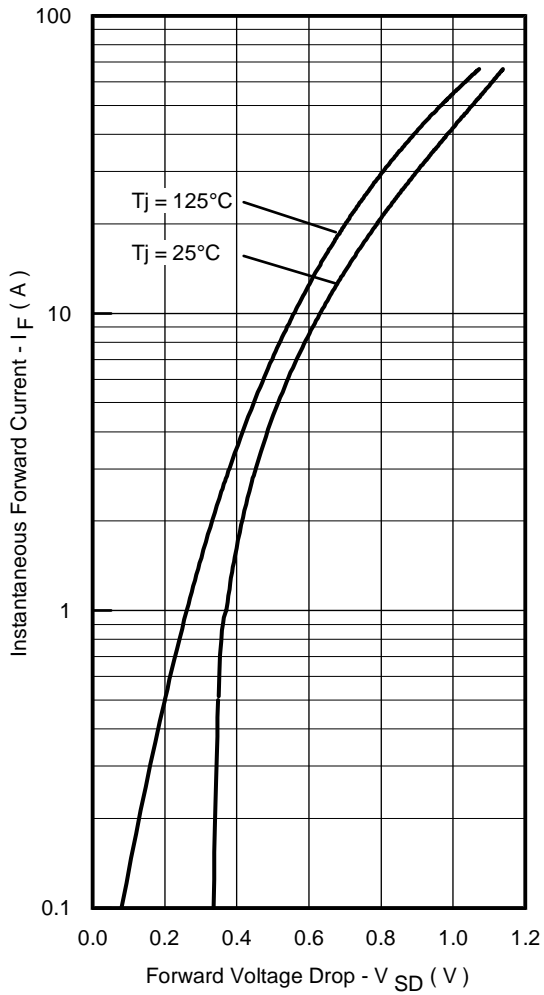

Fig. 12 - Typical Forward Voltage Drop Characteristics

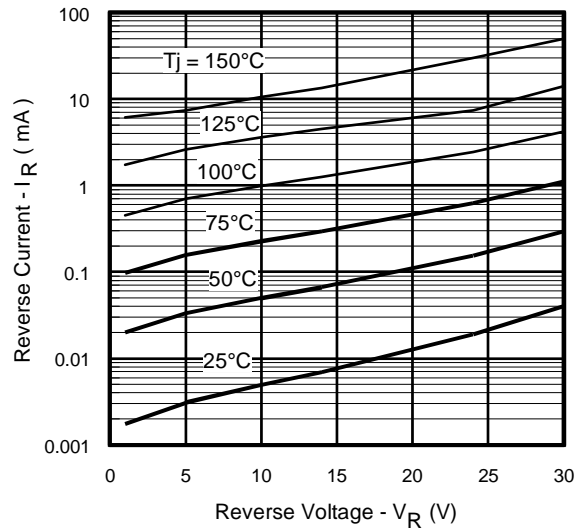
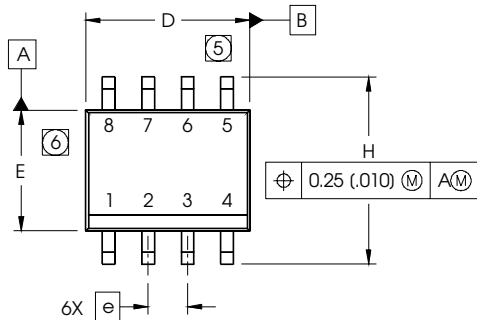

Fig. 13 - Typical Values of Reverse Current Vs. Reverse Voltage

SO-8 (Fetky) Package Outline

Dimensions are shown in millimeters (inches)



DIM	INCHES		MILLIMETERS	
	MIN	MAX	MIN	MAX
A	.0532	.0688	1.35	1.75
A1	.0040	.0098	0.10	0.25
b	.013	.020	0.33	0.51
c	.0075	.0098	0.19	0.25
D	.189	.1968	4.80	5.00
E	.1497	.1574	3.80	4.00
e	.050 BASIC		1.27 BASIC	
e1	.025 BASIC		0.635 BASIC	
H	.2284	.2440	5.80	6.20
K	.0099	.0196	0.25	0.50
L	.016	.050	0.40	1.27
y	0°	8°	0°	8°

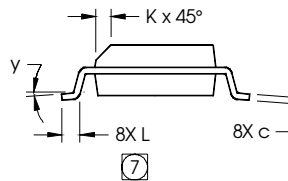
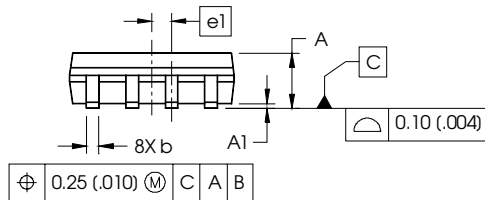

NOTES:

1. DIMENSIONING & TOLERANCING PER ASME Y14.5M-1994.
2. CONTROLLING DIMENSION: MILLIMETER
3. DIMENSIONS ARE SHOWN IN MILLIMETERS (INCHES).
4. OUTLINE CONFORMS TO JEDEC OUTLINE MS-012AA.
- ⑤ DIMENSION DOES NOT INCLUDE MOLD PROTRUSIONS. MOLD PROTRUSIONS NOT TO EXCEED 0.15 (.006).
- ⑥ DIMENSION DOES NOT INCLUDE MOLD PROTRUSIONS. MOLD PROTRUSIONS NOT TO EXCEED 0.25 (.010).
- ⑦ DIMENSION IS THE LENGTH OF LEAD FOR SOLDERING TO A SUBSTRATE.

FOOTPRINT

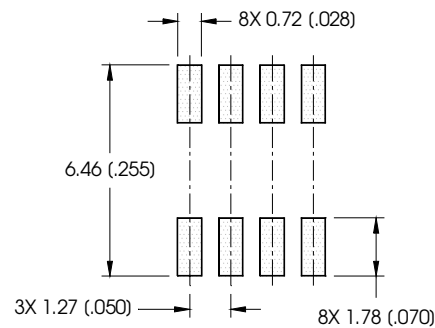

SO-8 (Fetky) Part Marking Information

EXAMPLE: THIS IS AN IRF7807D1 (FETKY)

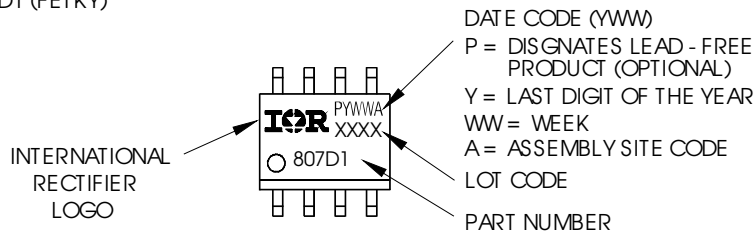

IRF7807D2PbF

International
IR Rectifier

SO-8 (Fetky) Tape and Reel

Dimensions are shown in millimeters (inches)

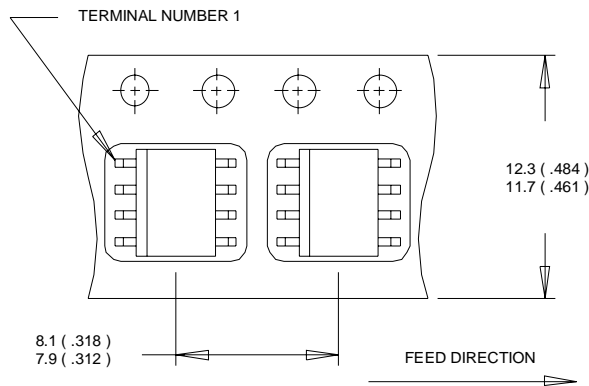

NOTES:

1. CONTROLLING DIMENSION : MILLIMETER.
2. ALL DIMENSIONS ARE SHOWN IN MILLIMETERS(INCHES).
3. OUTLINE CONFORMS TO EIA-481 & EIA-541.

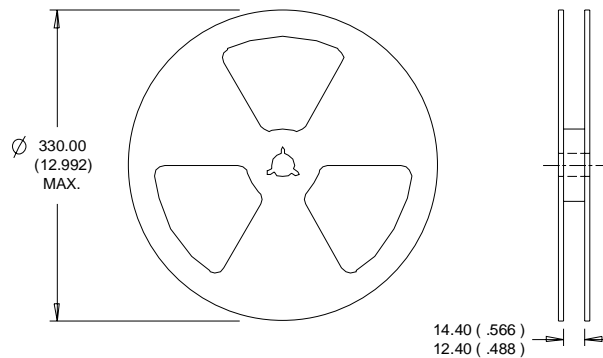

NOTES :

1. CONTROLLING DIMENSION : MILLIMETER.
2. OUTLINE CONFORMS TO EIA-481 & EIA-541.

Data and specifications subject to change without notice.
This product has been designed and qualified for the Consumer market.
Qualifications Standards can be found on IR's Web site.

International
IR Rectifier

IR WORLD HEADQUARTERS: 233 Kansas St., El Segundo, California 90245, USA Tel: (310) 252-7105
TAC Fax: (310) 252-7903

Visit us at www.irf.com for sales contact information.10/04