

CGA3E2X7R2A102K080AA

TDK Item Description : CGA3E2X7R2A102KT****



Equivalent C1608X7R2A102K for Automotive

Application & Main Feature

Automotive Grade (Mid Voltage (100 to 630V))

Series

CGA3(1608) [EIA CC0603]

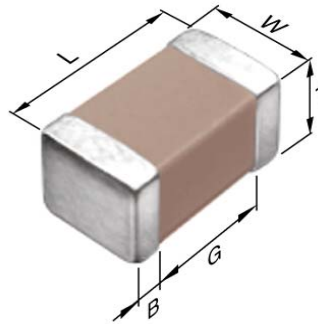

Dimensions

L 1.60mm +/-0.1mm
 W 0.80mm +/-0.1mm
 T 0.80mm +/-0.1mm
 B 0.20mm Min.
 G 0.30mm Min.

Temperature Characteristic

X7R (-55 to 125 degC +/-15%)

Rated Voltage

2A (100Vdc)

Capacitance

1nF

Capacitance Tolerance

K (+/-10%)

Dissipation Factor

3% Max.

Insulation Resistance

10Gohm Min.

AEC-Q200

Yes

DC Bias Characteristic

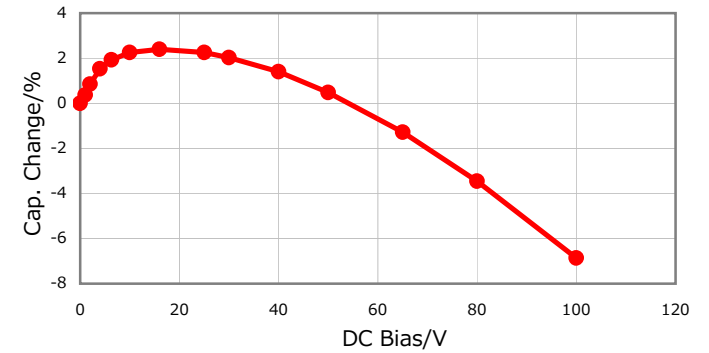

|Z|, ESR vs. Freq. Characteristics

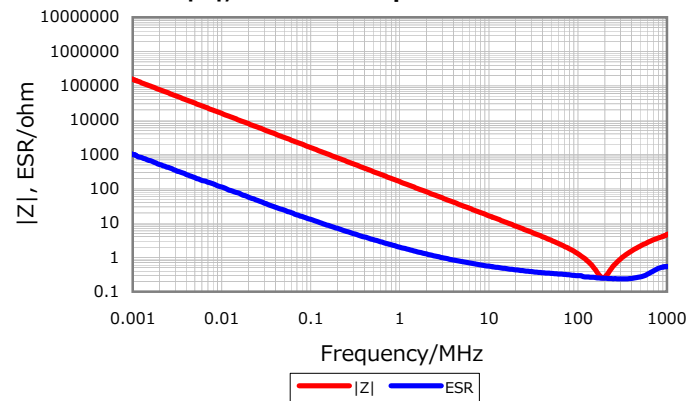

Temperature Characteristics

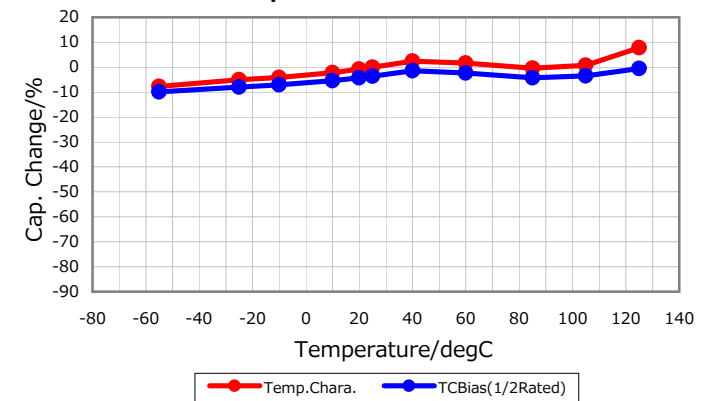

Cap. vs. Freq. Characteristic

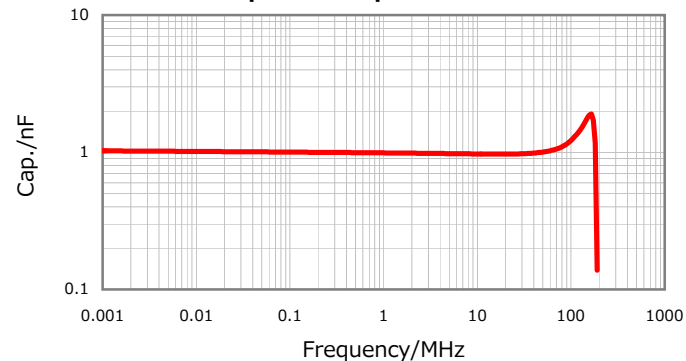

Ripple Temperature Rise Characteristics

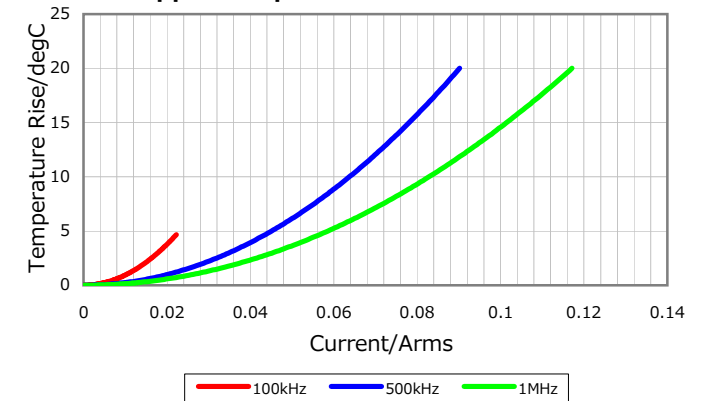

Characterization Sheet (Multilayer Ceramic Chip Capacitors)



All specifications are subject to change without notice.

January 4, 2016