



CLV651-0000

CLV65x

BAR CODE SCANNERS

SICK
Sensor Intelligence.



Ordering information

| Type | Part no. |
|-------------|----------|
| CLV651-0000 | 1046557 |

Other models and accessories → www.sick.com/CLV65x



Detailed technical data

Features

| | |
|---------------------------|---|
| Version | Low Density |
| Connection type | Cable |
| Reading field | Front |
| Scanner design | Line scanner |
| Focus | Auto focus |
| Light source | Visible red light (658 nm) |
| MTBF | 40,000 h |
| Laser class | 2 (EN 60825-1 (A2:2001-03), IEC 60825-1 : 2007-03, Ed. 2.0) |
| Aperture angle | ≤ 50° |
| Scanning frequency | 600 Hz ... 1,000 Hz |
| Code resolution | 0.5 mm |
| Reading distance | 170 mm ... 930 mm ¹⁾ |
| Heating | Optional |

¹⁾ For details see reading field diagram.

Performance

| | |
|---|---|
| Bar code types | All current code types, Code 39, Code 128, Code 93, Codabar, GS1-128 / EAN 128, UPC / GTIN / EAN, Interleaved 2 of 5, Pharmacode, GS1 DataBar, Telepen, MSI/Plessey |
| Print ratio | 2:1 ... 3:1 |
| No. of codes per scan | 1 ... 20 (Standard decoder) 1 ... 6 (SMART decoder) |
| No. of codes per reading interval | 1 ... 50 (auto-discriminating) |
| No. of characters per reading interval | 5,000 500 (for multiplexer function in CAN operation) |
| No. of multiple readings | 1 ... 99 |

Interfaces

| | |
|-----------------|---|
| PROFINET | ✓ |
| Function | PROFINET Dual Port (optional via external connection module CDF600-2) |

| | | |
|-------------------------------|------------------------------|--|
| EtherCAT® | | ✓ |
| | Type of fieldbus integration | Optional over external fieldbus module CDF600 |
| Serial | | ✓, RS-232, RS-422, RS-485 |
| | Function | Host, AUX |
| | Data transmission rate | 2,400 Baud ... 115.2 kBaud, AUX: 57.6 kBaud (RS-232) |
| CAN | | ✓ |
| | Function | SICK CAN sensor network (Master/Slave, Multiplexer/Server) |
| | Data transmission rate | 20 kbit/s ... 1 Mbit/s |
| CANopen | | ✓ |
| | Data transmission rate | 20 kbit/s ... 1 Mbit/s |
| PROFIBUS DP | | ✓ |
| | Type of fieldbus integration | Optional over external fieldbus module CDF600-2 |
| DeviceNet™ | | ✓ |
| | Type of fieldbus integration | Optional via external connection module CDM + CMF |
| Switching inputs | | 4 ("Sensor 1", "Sensor 2", 2 inputs via optional parameter storage CMC600 in CDB620/CDM420) |
| Switching outputs | | 4 ("Result 1", "Result 2", 2 outputs via optional parameter storage CMC600 in CDB620/CDM420) |
| Reading pulse | | Switching input "Sensor 1", non-powered, serial interface, auto pulse, CAN |
| Optical indicators | | 6 LEDs (Ready, Result, laser, Data, CAN, LNK TX, Bar graph for displaying the reading rate percentage (10 LEDs)) |
| Acoustic indicators | | Beeper/buzzer (can be switched off, can be allocated as a result indication function) |
| Operating elements | | 2 buttons (choose and start/stop functions) |
| Configuration software | | SOPAS ET |
| Memory card | | MicroSD memory card (flash card) 512 MB, optional |

Mechanics/electronics

| | |
|-------------------------------|--|
| Electrical connection | 1 x 15-pin D-Sub HD male connector (0.9 m) |
| Operating voltage | 18 V DC ... 30 V DC |
| Power consumption | 8.5 W |
| Housing | Aluminum die cast |
| Housing color | Light blue (RAL 5012) |
| Front screen | Glass |
| Enclosure rating | IP65 (EN 60529) |
| Protection class | III (EN 61140) |
| Weight | 320 g, with connecting cable |
| Dimensions (L x W x H) | 61 mm x 96 mm x 38 mm |

Ambient data

| | |
|--|--|
| Electromagnetic compatibility (EMC) | EN 61000-6-3 (2001-10) / EN 61000-6-2:2005 |
| Vibration resistance | EN 60068-2-6 (1995) |
| Shock resistance | EN 60068-2-27 (1993) |
| Ambient operating temperature | 0 °C ... +40 °C |
| Storage temperature | -20 °C ... +70 °C |
| Permissible relative humidity | 90 %, Non-condensing |

| | |
|--------------------------------------|-----------------------|
| Ambient light immunity | 2,000 lx, on bar code |
| Bar code print contrast (PCS) | ≥ 60 % |

General notes

| | |
|--------------------|--|
| Note on use | For Ethernet connection please use an Ethernet version of CLV6xx |
|--------------------|--|

Classifications

| | |
|-----------------------|----------|
| ECl@ss 5.0 | 27280102 |
| ECl@ss 5.1.4 | 27280102 |
| ECl@ss 6.0 | 27280102 |
| ECl@ss 6.2 | 27280102 |
| ECl@ss 7.0 | 27280102 |
| ECl@ss 8.0 | 27280102 |
| ECl@ss 8.1 | 27280102 |
| ECl@ss 9.0 | 27280102 |
| ETIM 5.0 | EC002550 |
| ETIM 6.0 | EC002550 |
| UNSPSC 16.0901 | 43211701 |

Dimensional drawing (Dimensions in mm (inch))

CLV63x/64x/65x Standard, front

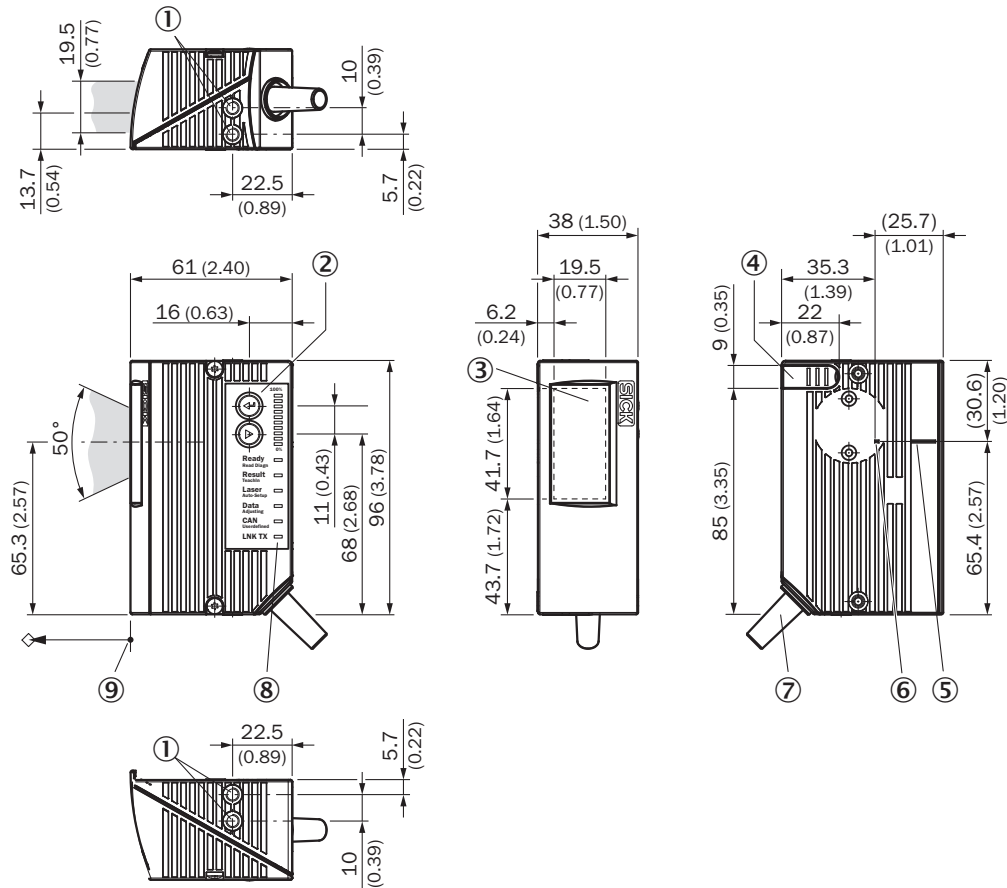

- ① Blind hole thread M5, 5 mm deep (2 x), for mounting
- ② Function button (2 x)
- ③ Reading field
- ④ Cover for the microSD memory card
- ⑤ Central position of the deflected laser beam in the V-shaped aperture angle
- ⑥ Internal impact point: rotation point of the variable direction laser beam
- ⑦ Cable with 15-pin D-sub HD male connector
- ⑧ LED status indicator (6x) and bar graph
- ⑨ Reference point for reading distance (from housing edge to object)



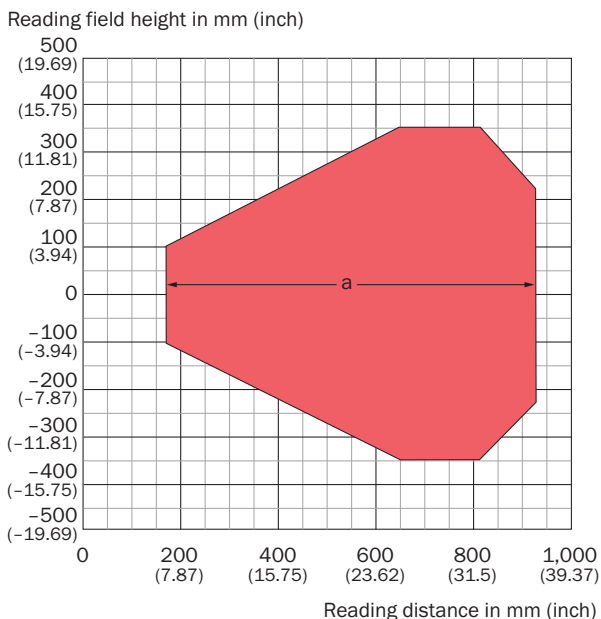



Reading field diagram



Resolution
■ a: 0.50 mm (19.7 mil)

Recommended accessories

Other models and accessories → www.sick.com/CLV65x

| | Brief description | Type | Part no. |
|---|--|------------------|----------|
| Mounting brackets and plates | | | |
|  | Hanger-shaped mounting bracket, thermally isolated for use with heating devices, mounting hardware included | Mounting bracket | 2050705 |
|  | Hanger-shaped mounting bracket, mounting hardware included | Mounting bracket | 2042800 |
| Modules | | | |
|  | Small connection module for one sensor, 4 cable glands, base for CMC600 | CDB620-001 | 1042256 |
|  | Fieldbus proxy/gateway for connecting identification sensors to PROFIBUS-DP networks (PROFIBUS interface: 2 x M12, male connector/female connector, 5-pin) | CDF600-2100 | 1058965 |
|  | Fieldbus proxy/gateway for connecting identification sensors to PROFIBUS-DP networks (PROFIBUS interface: 1 x D-Sub, female connector, 9-pin) | CDF600-2103 | 1058966 |
|  | Modular connection module for one sensor | CDM420-0001 | 1025362 |

SICK AT A GLANCE

SICK is one of the leading manufacturers of intelligent sensors and sensor solutions for industrial applications. A unique range of products and services creates the perfect basis for controlling processes securely and efficiently, protecting individuals from accidents and preventing damage to the environment.

We have extensive experience in a wide range of industries and understand their processes and requirements. With intelligent sensors, we can deliver exactly what our customers need. In application centers in Europe, Asia and North America, system solutions are tested and optimized in accordance with customer specifications. All this makes us a reliable supplier and development partner.

Comprehensive services complete our offering: SICK LifeTime Services provide support throughout the machine life cycle and ensure safety and productivity.

For us, that is “Sensor Intelligence.”

WORLDWIDE PRESENCE:

Contacts and other locations –www.sick.com