

**Full bridge + rectifier bridge
Trench + Field Stop IGBT3
Power Module**

**$V_{CES} = 600V$
 $I_C = 50A @ T_c = 80^\circ C$**

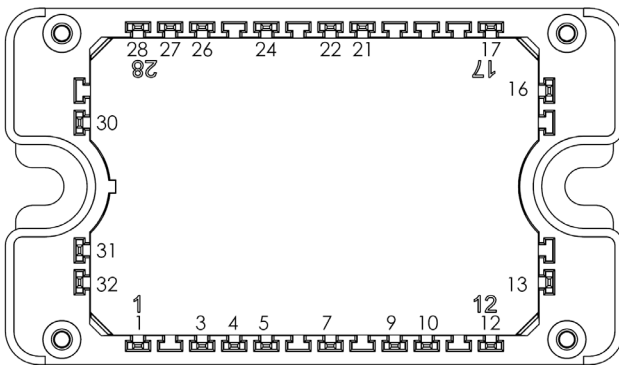
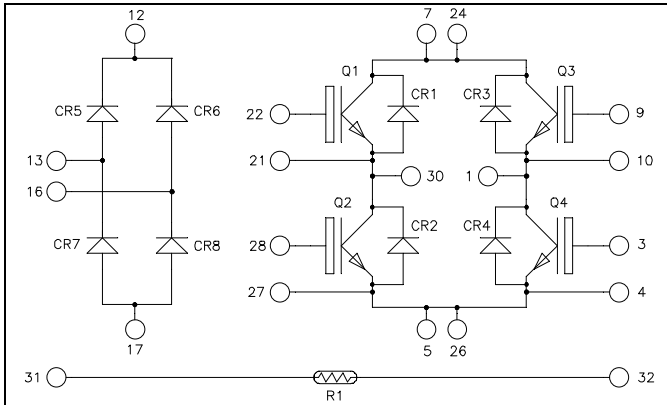

All multiple inputs and outputs must be shorted together
7/24 ; 5/26

Application

- Solar converter

Features

- Trench + Field Stop IGBT3 Technology
 - Low voltage drop
 - Low tail current
 - Switching frequency up to 20 kHz
 - Soft recovery parallel diodes
 - Low diode VF
 - Low leakage current
 - RBSOA and SCSOA rated
- Kelvin emitter for easy drive
- Very low stray inductance
- High level of integration
- Internal thermistor for temperature monitoring

Benefits

- Stable temperature behavior
- Very rugged
- Solderable terminals both for power and signal for easy PCB mounting
- Direct mounting to heatsink (isolated package)
- Low junction to case thermal resistance
- Easy paralleling due to positive TC of V_{CESat}
- Low profile
- RoHS Compliant

All ratings @ $T_j = 25^\circ C$ unless otherwise specified

CAUTION: These Devices are sensitive to Electrostatic Discharge. Proper Handling Procedures Should Be Followed. See application note APT0502 on www.microsemi.com

1. Full bridge
Absolute maximum ratings (per IGBT)

<i>Symbol</i>	<i>Parameter</i>	<i>Max ratings</i>	<i>Unit</i>
V _{CES}	Collector - Emitter Breakdown Voltage	600	V
I _C	Continuous Collector Current	T _C = 25°C	80
		T _C = 80°C	50
I _{CM}	Pulsed Collector Current	T _C = 25°C	100
V _{GE}	Gate - Emitter Voltage	±20	V
P _D	Maximum Power Dissipation	T _C = 25°C	176
RBSOA	Reverse Bias Safe Operating Area	T _J = 150°C	100A @ 550V

Electrical Characteristics (per IGBT)

<i>Symbol</i>	<i>Characteristic</i>	<i>Test Conditions</i>	<i>Min</i>	<i>Typ</i>	<i>Max</i>	<i>Unit</i>
I _{CES}	Zero Gate Voltage Collector Current	V _{GE} = 0V, V _{CE} = 600V			250	μA
V _{CE(sat)}	Collector Emitter Saturation Voltage	V _{GE} = 15V		1.5	1.9	V
		I _C = 50A	T _J = 25°C			
				1.7		
V _{GE(th)}	Gate Threshold Voltage	V _{GE} = V _{CE} , I _C = 600μA	5.0	5.8	6.5	V
I _{GES}	Gate - Emitter Leakage Current	V _{GE} = 20V, V _{CE} = 0V			600	nA

Dynamic Characteristics (per IGBT)

<i>Symbol</i>	<i>Characteristic</i>	<i>Test Conditions</i>	<i>Min</i>	<i>Typ</i>	<i>Max</i>	<i>Unit</i>
C _{ies}	Input Capacitance	V _{GE} = 0V V _{CE} = 25V f = 1MHz		3150		pF
C _{oes}	Output Capacitance			200		
C _{res}	Reverse Transfer Capacitance			95		
Q _G	Gate charge	V _{GE} = ±15V, I _C = 50A V _{CE} = 300V		0.5		μC
T _{d(on)}	Turn-on Delay Time	Inductive Switching (25°C) V _{GE} = ±15V V _{Bus} = 300V I _C = 50A R _G = 8.2Ω		110		ns
T _r	Rise Time			45		
T _{d(off)}	Turn-off Delay Time			200		
T _f	Fall Time			40		
T _{d(on)}	Turn-on Delay Time	Inductive Switching (150°C) V _{GE} = ±15V V _{Bus} = 300V I _C = 50A R _G = 8.2Ω		120		ns
T _r	Rise Time			50		
T _{d(off)}	Turn-off Delay Time			250		
T _f	Fall Time			60		
E _{on}	Turn-on Switching Energy	V _{GE} = ±15V V _{Bus} = 300V I _C = 50A	T _J = 25°C	0.3		mJ
			T _J = 150°C	0.43		
E _{off}	Turn-off Switching Energy	R _G = 8.2Ω	T _J = 25°C	1.35		mJ
			T _J = 150°C	1.75		
I _{sc}	Short Circuit data	V _{GE} ≤ 15V ; V _{Bus} = 360V t _p ≤ 6μs ; T _J = 150°C		250		A
R _{thJC}	Junction to Case Thermal Resistance				0.85	°C/W

Reverse diode ratings and characteristics (per diode)

<i>Symbol</i>	<i>Characteristic</i>	<i>Test Conditions</i>		<i>Min</i>	<i>Typ</i>	<i>Max</i>	<i>Unit</i>
V _{RRM}	Maximum Peak Repetitive Reverse Voltage			600			V
I _{RM}	Maximum Reverse Leakage Current	V _R =600V	T _j = 25°C			250	μA
			T _j = 150°C			500	
I _F	DC Forward Current	T _c = 80°C			50		A
V _F	Diode Forward Voltage	I _F = 50A V _{GE} = 0V	T _j = 25°C		1.6	2	V
			T _j = 150°C		1.5		
t _{rr}	Reverse Recovery Time		T _j = 25°C		100		ns
			T _j = 150°C		150		
Q _{rr}	Reverse Recovery Charge	I _F = 50A V _R = 300V di/dt = 1800A/μs	T _j = 25°C		2.6		μC
			T _j = 150°C		5.4		
E _{rr}	Reverse Recovery Energy		T _j = 25°C		0.6		mJ
			T _j = 150°C		1.2		
R _{thJC}	Junction to Case Thermal Resistance					1.42	°C/W

2. Rectifier bridge
Absolute maximum ratings (per diode)

<i>Symbol</i>	<i>Parameter</i>			<i>Max ratings</i>	<i>Unit</i>
V _R	Maximum DC reverse Voltage			600	V
V _{RRM}	Maximum Peak Repetitive Reverse Voltage				
I _{F(AV)}	Maximum Average Forward Current	Duty cycle = 50%	T _C = 80°C	40	A
I _{FSM}	Non-Repetitive Forward Surge Current	8.3ms	T _J = 45°C	320	

Electrical Characteristics (per diode)

<i>Symbol</i>	<i>Characteristic</i>	<i>Test Conditions</i>		<i>Min</i>	<i>Typ</i>	<i>Max</i>	<i>Unit</i>
V _F	Diode Forward Voltage	I _F = 30A			1.8	2.2	V
		I _F = 60A			2.2		
		I _F = 30A	T _j = 125°C		1.5		
I _{RM}	Maximum Reverse Leakage Current	V _R = 600V	T _j = 25°C			250	μA
			T _j = 125°C			500	

Dynamic Characteristics (per diode)

Symbol	Characteristic	Test Conditions		Min	Typ	Max	Unit
t_{rr}	Reverse Recovery Time	$I_F=1A, V_R=30V$ $di/dt = 100A/\mu s$	$T_j = 25^\circ C$		22		ns
t_{rr}	Reverse Recovery Time	$I_F = 30A$ $V_R = 400V$ $di/dt = 200A/\mu s$	$T_j = 25^\circ C$		25		ns
			$T_j = 125^\circ C$		160		
Q_{rr}	Reverse Recovery Charge		$T_j = 25^\circ C$		35		nC
			$T_j = 125^\circ C$		480		
I_{RRM}	Reverse Recovery Current		$T_j = 25^\circ C$		3		A
		$T_j = 125^\circ C$		6			
t_{rr}	Reverse Recovery Time	$I_F = 30A$ $V_R = 400V$ $di/dt = 1000A/\mu s$	$T_j = 125^\circ C$		85		ns
Q_{rr}	Reverse Recovery Charge				920		μC
I_{RRM}	Reverse Recovery Current				20		A
R_{thJC}	Junction to Case Thermal Resistance					1.2	$^\circ C/W$

3. Thermal and package characteristics
Temperature sensor NTC (see application note APT0406 on www.microsemi.com for more information).

Symbol	Characteristic	Min	Typ	Max	Unit
R_{25}	Resistance @ 25°C		50		k Ω
$\Delta R_{25}/R_{25}$			5		%
$B_{25/85}$	$T_{25} = 298.15 K$		3952		K
$\Delta B/B$	$T_C = 100^\circ C$		4		%

$$R_T = \frac{R_{25}}{\exp\left[B_{25/85}\left(\frac{1}{T_{25}} - \frac{1}{T}\right)\right]}$$

T: Thermistor temperature
 R_T : Thermistor value at T

Package characteristics

Symbol	Characteristic	Min	Typ	Max	Unit	
V_{ISOL}	RMS Isolation Voltage, any terminal to case t=1 min, 50/60Hz	4000			V	
T_J	Operating junction temperature range	-40		175	$^\circ C$	
T_{STG}	Storage Temperature Range	-40		125		
T_C	Operating Case Temperature	-40		100		
Torque	Mounting torque	To heatsink	M4	2	3	N.m
Wt	Package Weight				110	g

SP3 Package outline (dimensions in mm)

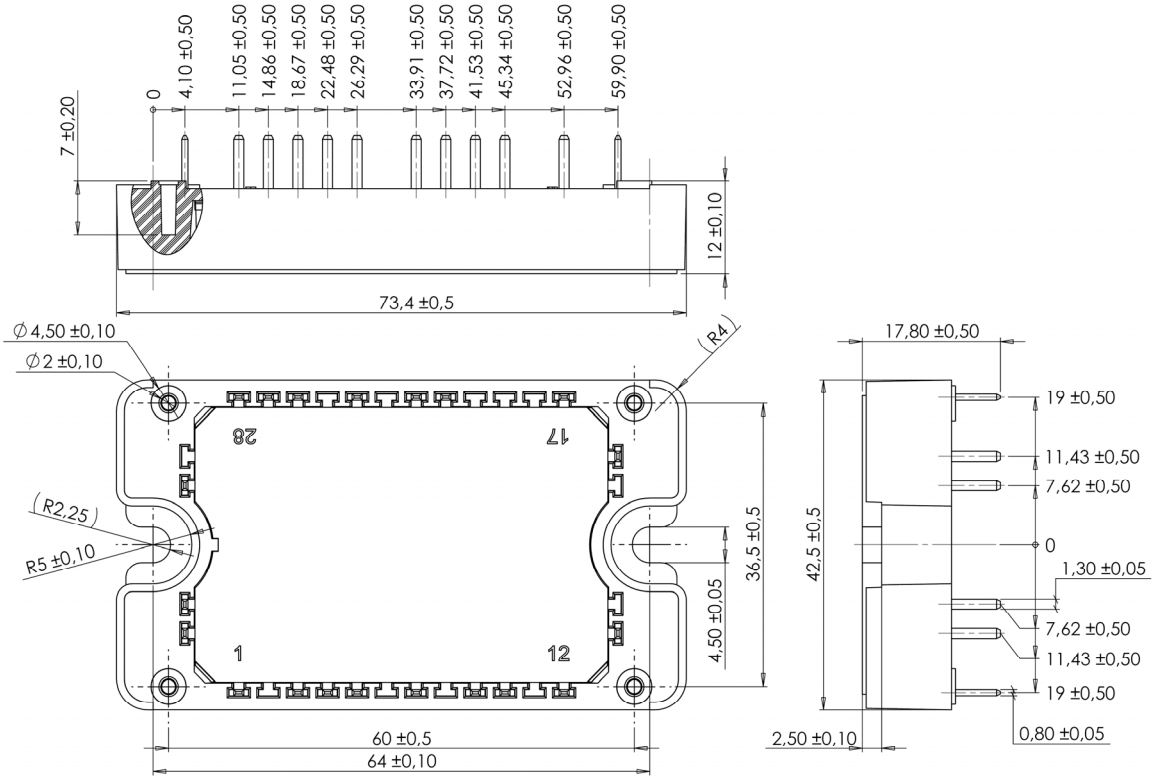

4. Typical full bridge Performance Curve (per IGBT and parallel diode)

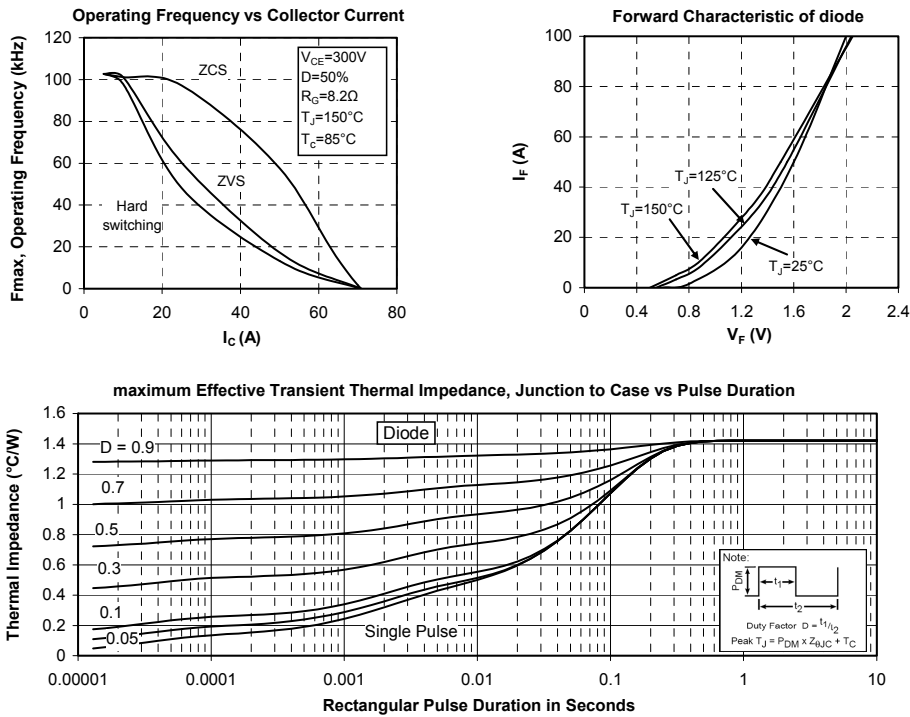

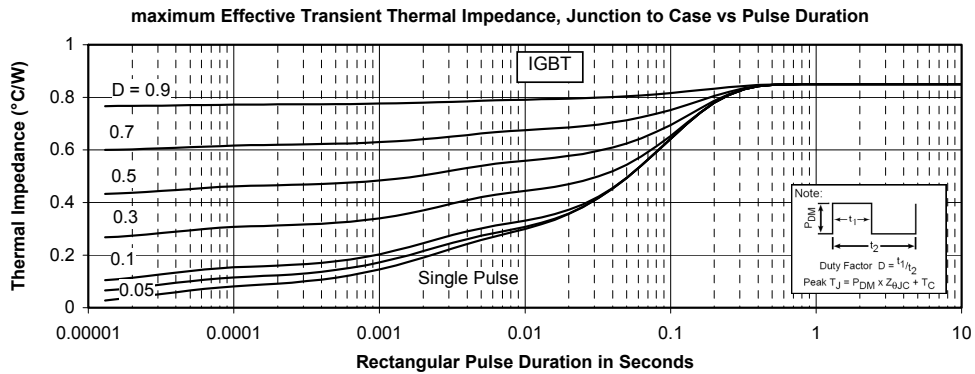
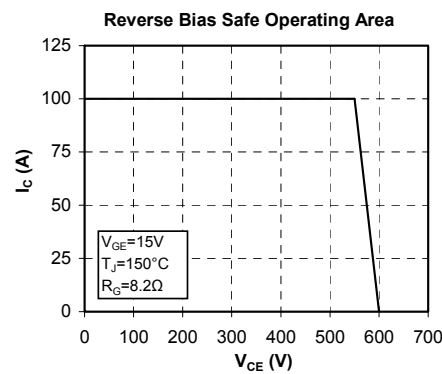
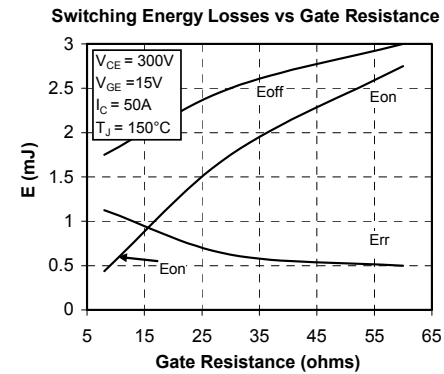
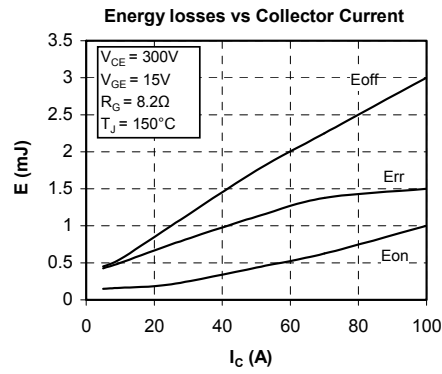
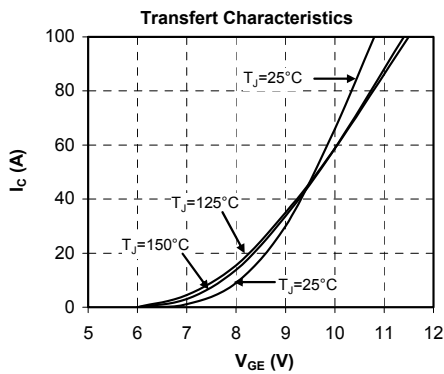
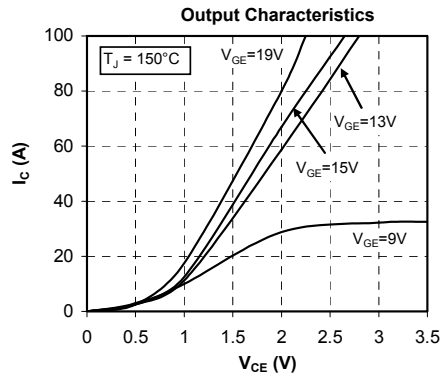
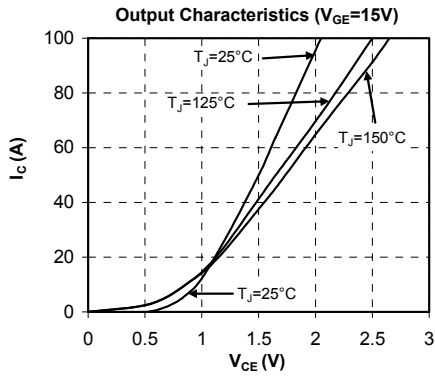

5. Typical rectifier bridge Performance Curve (per diode)

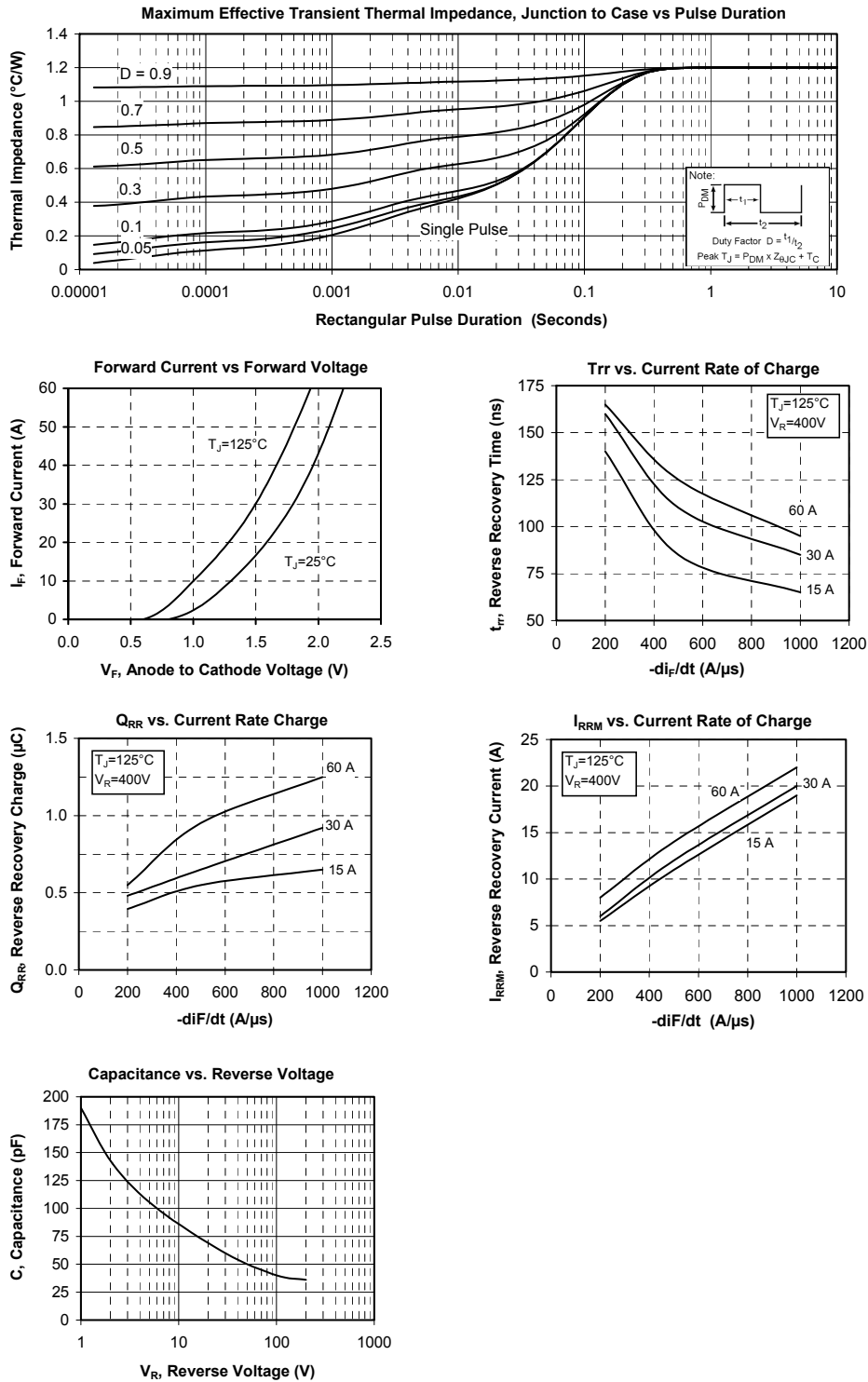

DISCLAIMER

The information contained in the document (unless it is publicly available on the Web without access restrictions) is PROPRIETARY AND CONFIDENTIAL information of Microsemi and cannot be copied, published, uploaded, posted, transmitted, distributed or disclosed or used without the express duly signed written consent of Microsemi. If the recipient of this document has entered into a disclosure agreement with Microsemi, then the terms of such Agreement will also apply. This document and the information contained herein may not be modified, by any person other than authorized personnel of Microsemi. No license under any patent, copyright, trade secret or other intellectual property right is granted to or conferred upon you by disclosure or delivery of the information, either expressly, by implication, inducement, estoppels or otherwise. Any license under such intellectual property rights must be approved by Microsemi in writing signed by an officer of Microsemi.

Microsemi reserves the right to change the configuration, functionality and performance of its products at anytime without any notice. This product has been subject to limited testing and should not be used in conjunction with life-support or other mission-critical equipment or applications. Microsemi assumes no liability whatsoever, and Microsemi disclaims any express or implied warranty, relating to sale and/or use of Microsemi products including liability or warranties relating to fitness for a particular purpose, merchantability, or infringement of any patent, copyright or other intellectual property right. Any performance specifications believed to be reliable but are not verified and customer or user must conduct and complete all performance and other testing of this product as well as any user or customers final application. User or customer shall not rely on any data and performance specifications or parameters provided by Microsemi. It is the customer's and user's responsibility to independently determine suitability of any Microsemi product and to test and verify the same. The information contained herein is provided "AS IS, WHERE IS" and with all faults, and the entire risk associated with such information is entirely with the User. Microsemi specifically disclaims any liability of any kind including for consequential, incidental and punitive damages as well as lost profit. The product is subject to other terms and conditions which can be located on the web at <http://www.microsemi.com/legal/tnc.asp>

Life Support Application

Seller's Products are not designed, intended, or authorized for use as components in systems intended for space, aviation, surgical implant into the body, in other applications intended to support or sustain life, or for any other application in which the failure of the Seller's Product could create a situation where personal injury, death or property damage or loss may occur (collectively "Life Support Applications").

Buyer agrees not to use Products in any Life Support Applications and to the extent it does it shall conduct extensive testing of the Product in such applications and further agrees to indemnify and hold Seller, and its officers, employees, subsidiaries, affiliates, agents, sales representatives and distributors harmless against all claims, costs, damages and expenses, and attorneys' fees and costs arising, directly or indirectly, out of any claims of personal injury, death, damage or otherwise associated with the use of the goods in Life Support Applications, even if such claim includes allegations that Seller was negligent regarding the design or manufacture of the goods.

Buyer must notify Seller in writing before using Seller's Products in Life Support Applications. Seller will study with Buyer alternative solutions to meet Buyer application specification based on Sellers sales conditions applicable for the new proposed specific part.