

12-16GHz Direct Quadrature Modulator

GaAs Monolithic Microwave IC in SMD leadless package

Description

The CHM1483-QFG is a packaged 12-16GHz direct quadrature modulator which integrates a double-balanced mixer (LO suppression and Image Rejection) and a LO buffer. It can be used for both LSB and USB configurations.

The circuit is mainly dedicated to Point to Point and Point to Multi-Point systems and also well suited for a wide range of microwave applications.

The circuit is manufactured with a pHEMT process, 0.5µm gate length.

It is supplied in RoHS compliant SMD package.

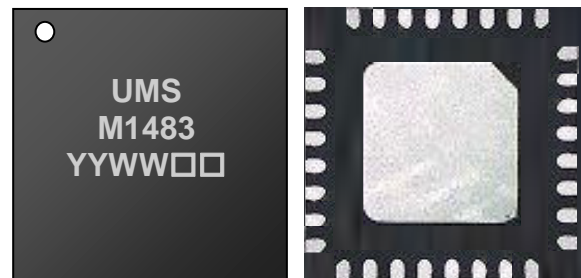

Main Features

- RF Broadband performances: 12-16GHz
- Input Broadband bandwidth: DC-1GHz
- 10dB Conversion Losses
- 25dBc Image Rejection
- -30dBm LO leakage without cancelation
- -70dBm LO leakage with cancelation
- 0dBm LO input Power
- 32L-QFN5x5
- MSL2

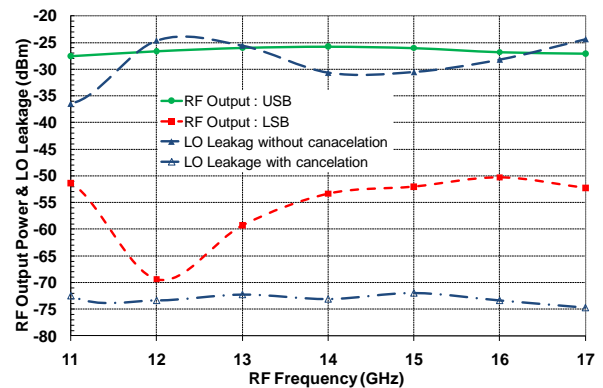

Main Electrical Characteristics

T_{amb.} = +25°C

Symbol	Parameter	Min	Typ	Max	Unit
F _{RF}	Output RF Frequency range	12		16	GHz
F _{LO}	LO Frequency range	12		16	GHz
F _{IF}	Base band bandwidth	DC		1000	MHz
L _c	Conversion Losses		10		dB

Electrical Characteristics

T_{amb.} = +25°C, VD1 = VD2 = VD3 = +4V

Symbol	Parameter	Min	Typ	Max	Unit
F _{RF}	RF Frequency range	12		16	GHz
F _{LO}	LO Frequency range	12		16	GHz
F _{BB}	Baseband input 1dB bandwidth	DC		1000	MHz
L _c	Conversion Losses ⁽¹⁾		10		dB
P _{LO}	LO input power		0		dBm
LO_leak	LO leakage ^{(1) (2)}		-30		dBm
LO_sup	LO cancelation ^{(1) (3)}		-70		dBm
IM_rej	Image Rejection ⁽¹⁾		25		dBc
RL _{LO}	LO Input Return Loss (@P _{LO} =0dBm)		-8		dB
RL _{RF}	RF Input Return Loss		-10		dB
OIP3	Output IP3		12		dBm
IMD2	2 nd order intermodulation ratio		40		dBc
N	Noise Floor		-150		dBm/Hz
Amp_bal	I/Q Amplitude balance	-1		+1	dB
Ph_err	Quadrature Phase error	-7		+7	°
V _{I_DC}	Baseband I DC voltage differential mode ⁽⁴⁾	-0.2		+0.2	V
V _{Q_DC}	Baseband Q DC voltage differential mode ⁽⁴⁾	-0.2		+0.2	V
V _{BBI}	Baseband I AC voltage differential mode ⁽⁵⁾	-0.8		0.8	V
V _{BBQ}	Baseband Q AC voltage differential mode ⁽⁵⁾	-0.8		0.8	V
VDx	DC supply voltage		4		V
VG	Mixer gate bias voltage		-0.7		V
Idq	DC quiescent current		100		mA

⁽¹⁾ Given F_{BB} = 10MHz, P_{LO} = 0dBm and V_{BBI} = V_{BBQ} = 50mV_{pp} (Each baseband input impedance single ended is 50Ω: i.e. P_{BB_Total} = -16dB), for these conditions: P_{RF} = -26dBm

⁽²⁾ LO leakage without cancelation (i.e. no DC tuning: V_{I_DC} = V_{Q_DC} = 0V)

⁽³⁾ LO leakage cancelation (i.e. with DC tuning on V_{I_DC} and V_{Q_DC})

⁽⁴⁾ Use to cancel LO leakage. Differential mode means voltages through I and IB are in opposition. Tuning adjustment are need for each frequency, temperature and LO power.

⁽⁵⁾ Peak to Peak Voltage.

These values are representative of onboard measurements as defined on the drawing in paragraph "Evaluation mother board".

Absolute Maximum Ratings ⁽¹⁾

Tamb.= +25°C

Symbol	Parameter	Values	Unit
VDx	Drain bias voltage	4.5	V
Idq	DC quiescent current	120	mA
VG	Gate bias voltage	-2 to +0.4	V
Tj	Junction temperature	175	°C
Ta	Operating temperature range	-40 to +85	°C
Tstg	Storage temperature range	-55 to +150	°C

⁽¹⁾ Operation of this device above anyone of these parameters may cause permanent damage.

Typical Bias Conditions

Tamb.= +25°C

Symbol	Pad N°	Parameter	Values	Unit
VD1	9	Drain 1 bias voltage	4	V
VD2	10	Drain 2 bias voltage	4	V
VD3	11	Drain 3 bias voltage	4	V
VG	27	Mixer gate bias voltage	-0.7	V

Device thermal performances

All the figures given in this section are obtained assuming that the QFN device is cooled down only by conduction through the package thermal pad (no convection mode considered). The temperature is monitored at the package back-side interface (Tcase) as shown below. The system maximum temperature must be adjusted in order to guarantee that Tcase remains below the maximum value specified in the next table. So, the system PCB must be designed to comply with this requirement.

A derating must be applied on the dissipated power if the Tcase temperature cannot be maintained below the maximum temperature specified (see the curve Pdiss. Max.) in order to guarantee the nominal device life time (MTTF).

DEVICE THERMAL SPECIFICATION : CHM1483-QFG	
Recommended max. junction temperature (Tj max)	: 126 °C
Junction temperature absolute maximum rating	: 175 °C
Max. continuous dissipated power (Pdiss. Max.)	: 0.4 W
=> Pdiss. Max. derating above Tcase ⁽¹⁾ = 85 °C	: 10 mW/°C
Junction-Case thermal resistance (Rth J-C) ⁽²⁾	: <101 °C/W
Minimum Tcase operating temperature ⁽³⁾	: -40 °C
Maximum Tcase operating temperature ⁽³⁾	: 85 °C
Minimum storage temperature	: -55 °C
Maximum storage temperature	: 150 °C

(1) Derating at junction temperature constant = Tj max.

(2) Rth J-C is calculated for a worst case considering the **hottest junction** of the MMIC and all the devices biased.

(3) Tcase=Package back side temperature measured under the die-attach-pad (see the drawing below).

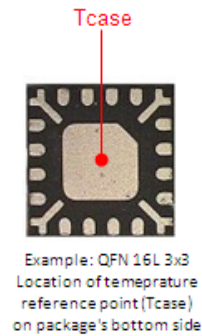
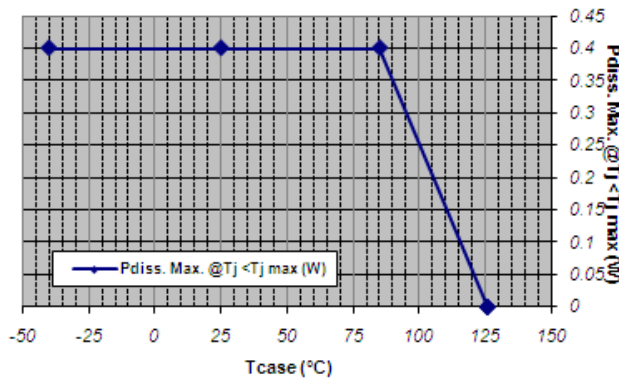

6.4

Typical on Board Measurements

Tamb.= +25°C, VD1 = VD2 = VD3 = +4V, Idq = 100mA

USB versus RF Frequency

$F_{BB} = 10\text{MHz} / V_{BBI} = V_{BBQ} = 50\text{mVpp}$
 $P_{LO} = 0\text{dBm}$

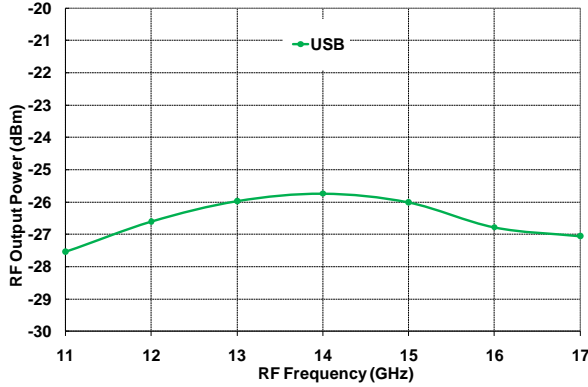

LSB Rejection versus RF Frequency

$F_{BB} = 10\text{MHz} / V_{BBI} = V_{BBQ} = 50\text{mVpp}$
 $P_{LO} = 0\text{dBm}$

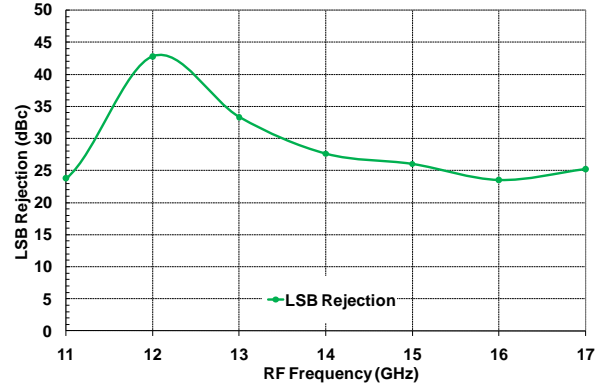

LO leakage versus RF Frequency

$F_{BB} = 10\text{MHz} / V_{BBI} = V_{BBQ} = 50\text{mVpp}$
 $P_{LO} = 0\text{dBm}$

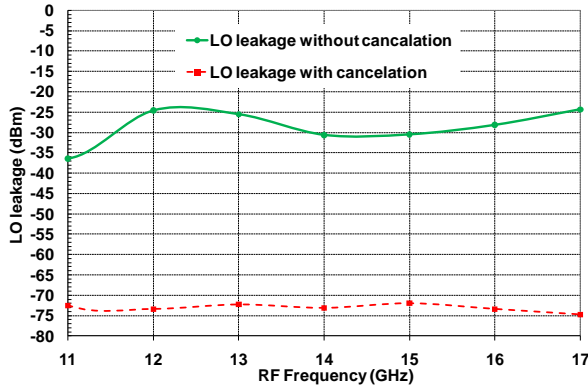

LO leakage versus LO Input Power

$F_{BB} = 10\text{MHz} / V_{BBI} = V_{BBQ} = 50\text{mVpp}$
 $P_{LO} = 0\text{dBm}$

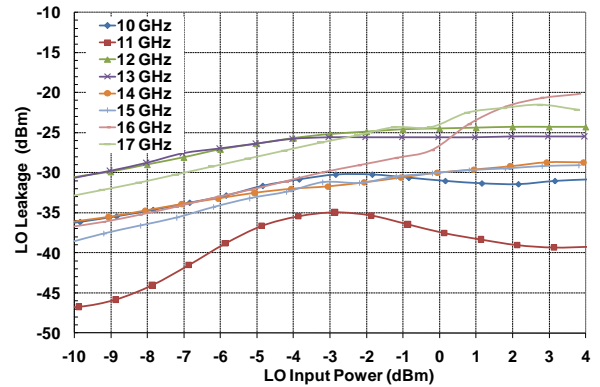

USB versus LO Input Power

$F_{BB} = 10\text{MHz} / V_{BBI} = V_{BBQ} = 50\text{mVpp}$
 $F_{LO}: [10 \text{ to } 17 / 1] \text{ GHz}$

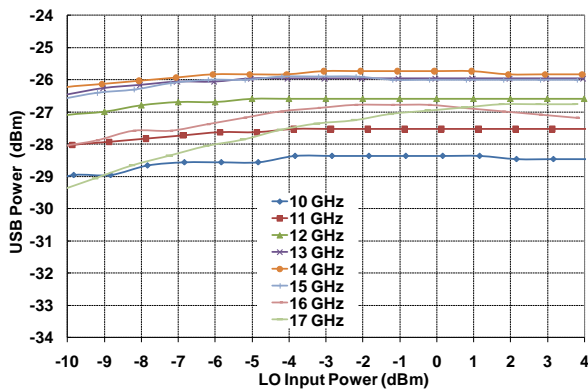

DC Supply Current versus LO Input Power

$F_{BB} = 10\text{MHz} / V_{BBI} = V_{BBQ} = 50\text{mVpp}$
 $F_{LO}: [10 \text{ to } 17 / 1] \text{ GHz}$

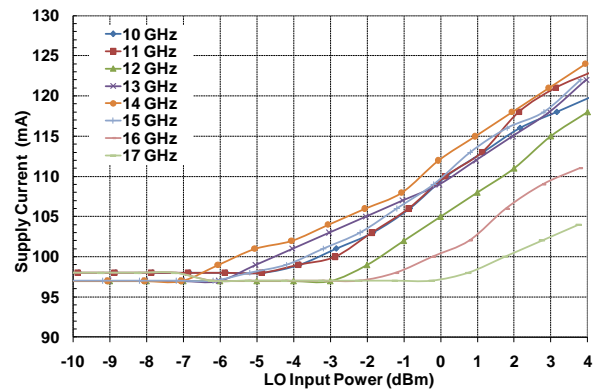

Temperature Board Measurements

VD1 = VD2 = VD3 = +4V, Idq = 100mA

USB versus RF Frequency

$F_{BB} = 10\text{MHz} / V_{BBI} = V_{BBQ} = 50\text{mVpp}$
 $P_{LO} = 0\text{dBm}$

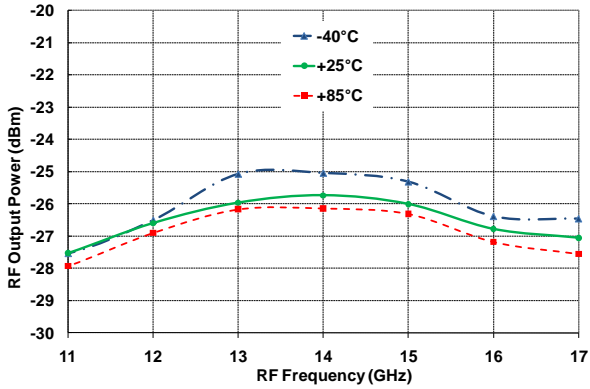

LSB Rejection versus RF Frequency

$F_{BB} = 10\text{MHz} / V_{BBI} = V_{BBQ} = 50\text{mVpp}$
 $P_{LO} = 0\text{dBm}$

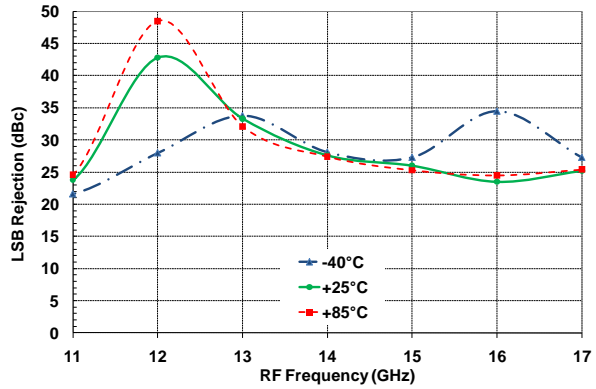

LO leakage versus RF Frequency

$F_{BB} = 10\text{MHz} / V_{BBI} = V_{BBQ} = 50\text{mVpp}$
 $P_{LO} = 0\text{dBm} / V_{I_DC} = V_{Q_DC} = 0\text{V}$

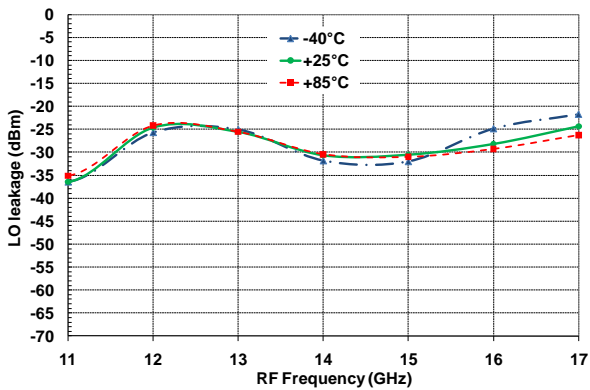

LO cancelation versus RF Frequency

$F_{BB} = 10\text{MHz} / V_{BBI} = V_{BBQ} = 50\text{mVpp}$
 $P_{LO} = 0\text{dBm} / V_{I_DC} \text{ \& } V_{Q_DC} \text{ tuned}$

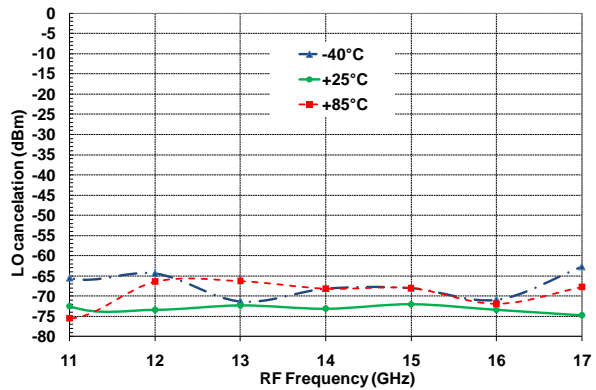

Package outline ⁽¹⁾

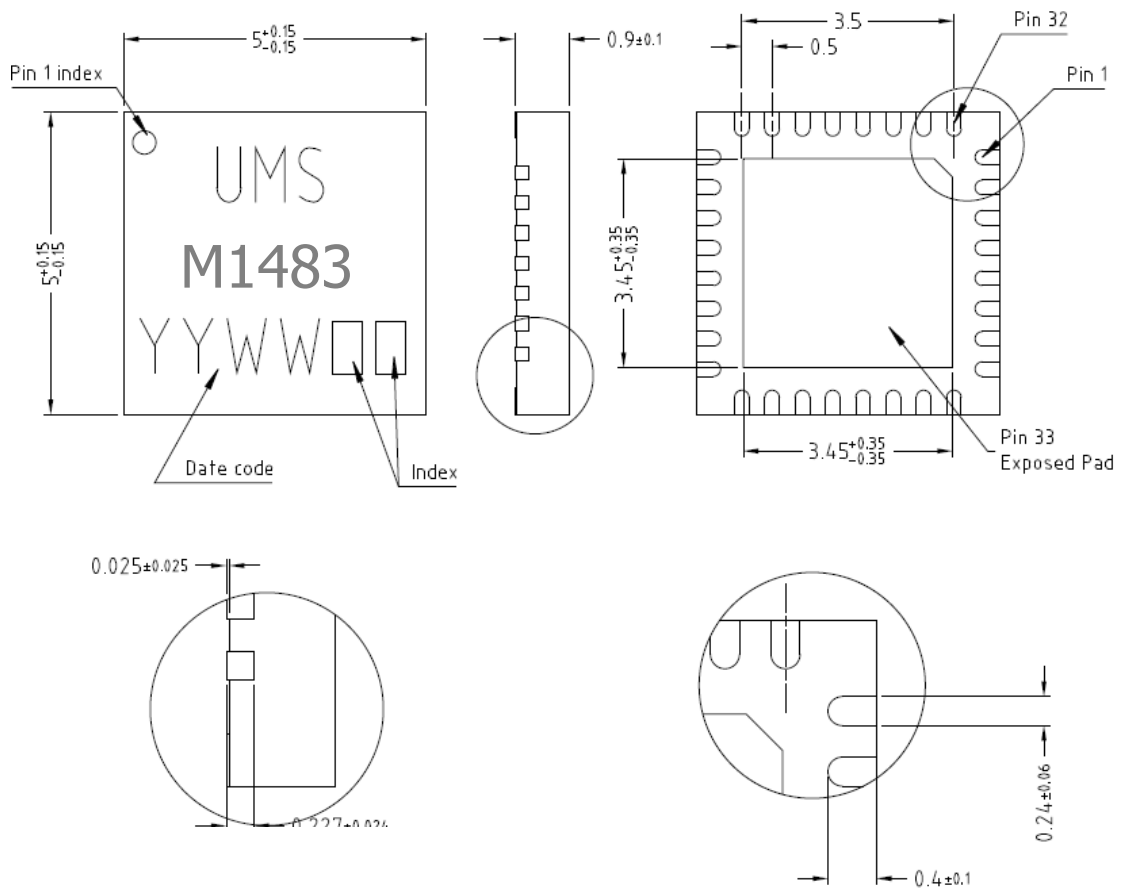

Matt tin, Lead Free (Green)		1- Nc	12- Nc	23- Gnd ⁽²⁾
Units : mm		2- Nc	13- Nc	24- Nc
From the standard : JEDEC MO-220 (VHHD)		3- Nc	14- Nc	25- IB
		4- Nc	15- Nc	26- I
	33- GND	5- Nc	16- Gnd ⁽²⁾	27- VG
		6- Gnd ⁽²⁾	17- Nc	28- Nc
		7- LO	18- Nc	29- Q
		8- Gnd ⁽²⁾	19- Nc	30- QB
		9- VD1	20- Nc	31- Gnd ⁽²⁾
		10- VD2	21- Gnd ⁽²⁾	32- Nc
		11- VD3	22- RF	

⁽¹⁾ The package outline drawing included to this data-sheet is given for indication. Refer to the application note AN0017 (<http://www.ums-gaas.com>) for exact package dimensions.

⁽²⁾ It is strongly recommended to ground all pins marked “Gnd” through the PCB board. Ensure that the PCB board is designed to provide the best possible ground to the package.

Evaluation mother board

- Compatible with the proposed footprint.
- Based on typically Ro4003 / 8mils or equivalent.
- Using a micro-strip to coplanar transition to access the package.
- Recommended for the implementation of this product on a module board.
- Decoupling capacitors of 10nF \pm 10% are recommended for all DC accesses.
- See application note AN0017 for details.

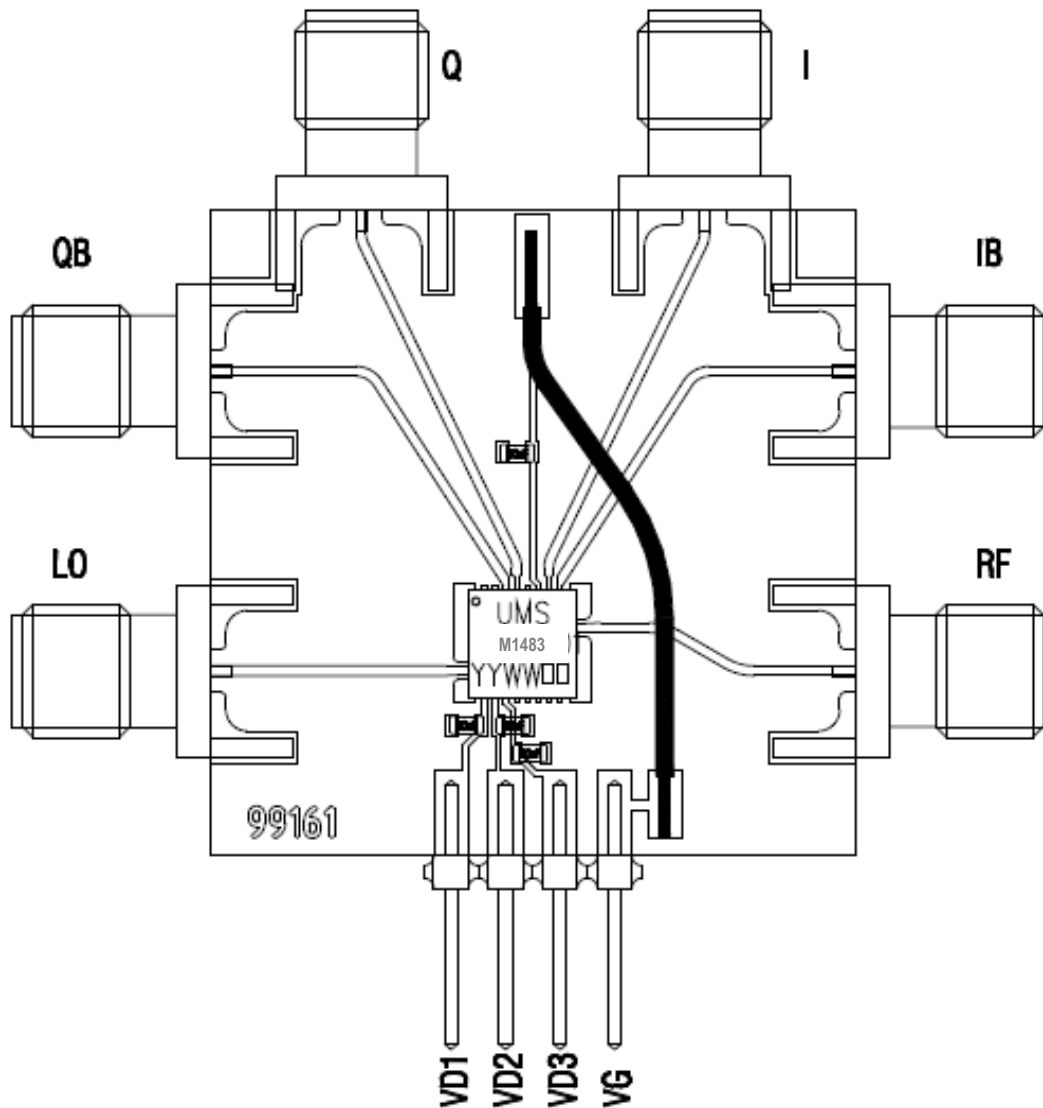

Notes

ESD protections are implemented on LO port, RF port, baseband ports, drain and gate ports.

The DC connections do not include any decoupling capacitor in package, therefore it is mandatory to provide a good external DC decoupling (10nF) on the PC board, as close as possible to the package.

Recommended package footprint

Refer to the application note AN0017 available at <http://www.ums-gaas.com> for package footprint recommendations.

SMD mounting procedure

For the mounting process standard techniques involving solder paste and a suitable reflow process can be used. For further details, see application note AN0017.

Recommended environmental management

UMS products are compliant with the regulation in particular with the directives RoHS N°2011/65 and REACH N°1907/2006. More environmental data are available in the application note AN0019 also available at <http://www.ums-gaas.com>.

Recommended ESD management

Refer to the application note AN0020 available at <http://www.ums-gaas.com> for ESD sensitivity and handling recommendations for the UMS package products.

Ordering Information

QFN 5x5 RoHS compliant package:

CHM1483-QFG/XY

Stick: XY = 20

Tape & reel: XY = 21

Information furnished is believed to be accurate and reliable. However **United Monolithic Semiconductors S.A.S.** assumes no responsibility for the consequences of use of such information nor for any infringement of patents or other rights of third parties which may result from its use. No license is granted by implication or otherwise under any patent or patent rights of **United Monolithic Semiconductors S.A.S.** Specifications mentioned in this publication are subject to change without notice. This publication supersedes and replaces all information previously supplied. **United Monolithic Semiconductors S.A.S.** products are not authorised for use as critical components in life support devices or systems without express written approval from **United Monolithic Semiconductors S.A.S.**