



# 2SC5200 SERIES

## 用途

- 应用于功率放大器

## 产品特性

- 高集电极电压:  $V_{CE0}=230V$  (min)  
 $V_{CE0}=250V$  (min)
- 与 2SA1943 互补
- 推荐用于 100W 音响频率放大器输出电路
- 环保 (RoHS) 产品

## APPLICATIONS

- Power Amplifier Applications

## FEATURES

- High collector voltage:  $V_{CE0}=230V$  (min)  
 $V_{CE0}=250V$  (min)
- Complementary to 2SA1943
- Recommended for 100W audio frequency amplifier output
- RoHS product

## 封装 Package

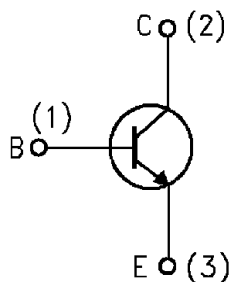

TO-3PL(T)

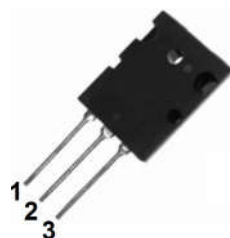

TO-3PB

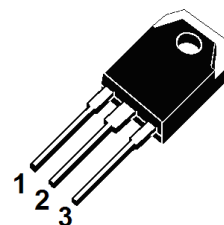

- 1 基极 BASE      3 发射极 EMITTER  
2 集电极 (热沉) COLLECTOR (HEAT SINK)

## 订货信息 ORDER MESSAGE

订货型号 Order codes	印 记 Marking	无卤素 Halogen Free	封 装 Package	包 装 Packaging	器件重量 Weight
2SC5200-O-AL-N-D	2SC5200	否 NO	TO-3PL(T)	泡沫盒 Foam Box	9.53g(typ)
2SC5200-O-AL-N-B	2SC5200	否 NO	TO-3PL(T)	条管 Tube	9.53g(typ)
2SC5200-O-AB -N-B	2SC5200	否 NO	TO-3PB	条管 Tube	6.03g(typ)
2SC5200A-O-AL-N-D	2SC5200	否 NO	TO-3PL(T)	泡沫盒 Foam Box	9.53g(typ)
2SC5200A-O-AL-N-B	2SC5200	否 NO	TO-3PL(T)	条管 Tube	9.53g(typ)
2SC5200A-O-AB -N-B	2SC5200	否 NO	TO-3PB	条管 Tube	6.03g(typ)
2SC5200B -O-AL-N-B	2SC5200	否 NO	TO-3PL(T)	条管 Tube	9.53g(typ)
2SC5200B -O-AL-N-D	2SC5200	否 NO	TO-3PL(T)	泡沫盒 Foam Box	9.53g(typ)
2SC5200B-O-AB -N-B	2SC5200	否 NO	TO-3PB	条管 Tube	6.03g(typ)
2SC5200C -O-AL-N-B	2SC5200	否 NO	TO-3PL(T)	条管 Tube	9.53g(typ)
2SC5200C -O-AL-N-D	2SC5200	否 NO	TO-3PL(T)	泡沫盒 Foam Box	9.53g(typ)
2SC5200C-O-AB -N-B	2SC5200	否 NO	TO-3PB	条管 Tube	6.03g(typ)



**绝对最大额定值 ABSOLUTE RATINGS** (Tc=25℃ unless otherwise noted)

项 目 Parameter	符 号 Symbol	数 值 Value				单 位 Unit
		-	A	B	C	
集电极—基极直流电压 Collector- Base Voltage	V <sub>CB0</sub>	230	230	350	350	V
集电极—发射极直流电压 Collector- Emitter Voltage	V <sub>CEO</sub>	230	230	250	250	V
发射极—基极直流电压 Emitter-Base Voltage	V <sub>EBO</sub>	5				V
最大集电极电流 Collector Current	I <sub>C</sub>	15	15	16	16	A
最大基极电流 Base Current	I <sub>B</sub>	1.5		1.6		A
最大集电极耗散功率 TO-3PB Collector Dissipation(Tc=25℃)	P <sub>C</sub>	120		150		W
最大集电极耗散功率 TO-3PL Collector Dissipation(Tc=25℃)	P <sub>C</sub>	160		200		W
最高结温 Junction Temperature	T <sub>j</sub>	150				℃
贮存温度 Storage Temperature	T <sub>stg</sub>	-65~150				℃

**电特性 ELECTRICAL CHARACTERISTIC**

项 目 Parameter	测试条件 Tests conditions	最小值 Value(min)				典型值 Value(typ)	最大值 Value(max)				单位 Unit
		5200	A	B	C		5200	A	B	C	
I <sub>CB0</sub>	V <sub>CB</sub> =230(300)V, I <sub>E</sub> =0	-				-	5.0@230V	5.0@300V			μA
I <sub>EBO</sub>	V <sub>EB</sub> =5V, I <sub>C</sub> =0	-				-	5.0				mA
V <sub>(BR)CEO</sub>	I <sub>C</sub> =50mA, I <sub>B</sub> =0	230		250		-	-				V
hFE	V <sub>CE</sub> =5V, I <sub>C</sub> =0.5A	-		75		-	-	135			-
	V <sub>CE</sub> =5V, I <sub>C</sub> =1.0A	80		75		-	160	135			-
	V <sub>CE</sub> =5V, I <sub>C</sub> =3.0A	-		75		-	-	135			-
	V <sub>CE</sub> =5V, I <sub>C</sub> =7.0A	35		-		-	-	-			-
V <sub>CE(sat)</sub>	I <sub>C</sub> =5.0A, I <sub>B</sub> =0.5A	-				-	-	1.0			V
	I <sub>C</sub> =8.0A, I <sub>B</sub> =0.8A	-				-	3.0	-			V
V <sub>BE</sub>	V <sub>CE</sub> =5V, I <sub>C</sub> =7.0A	-				-	1.5				V
f <sub>T</sub>	V <sub>CE</sub> =5V, I <sub>C</sub> =1.0A	10	30	10	30	-	-				MHz
C <sub>Ob</sub>	V <sub>CE</sub> =10V, I <sub>E</sub> =0, f=1MHz	-				145	-				pF

**热特性 THERMAL CHARACTERISTIC**

项 目 Parameter	符 号 Symbo	最小值 min	最大值 max	单 位 Unit
<b>2SC5200 2SC5200A</b>				
结到管壳的热阻 Thermal Resistance Junction Case TO-3PB	R <sub>th(j-c)</sub>	-	1.042	℃/W
结到管壳的热阻 Thermal Resistance Junction Case TO-3PL(T)	R <sub>th(j-c)</sub>	-	0.781	℃/W
<b>2SC5200B 2SC5200C</b>				
结到管壳的热阻 Thermal Resistance Junction Case TO-3PB	R <sub>th(j-c)</sub>	-	0.83	℃/W
结到管壳的热阻 Thermal Resistance Junction Case TO-3PL(T)	R <sub>th(j-c)</sub>	-	0.625	℃/W





## 特征曲线 ELECTRICAL CHARACTERISTICS (2SC5200 curves)

### IC-VCE

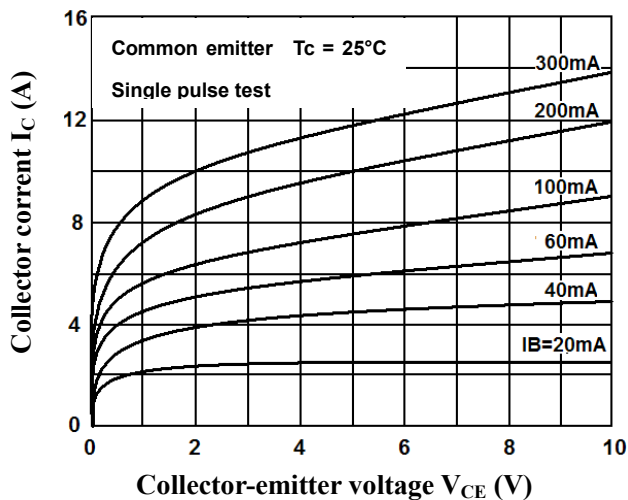

### DC Current Gain

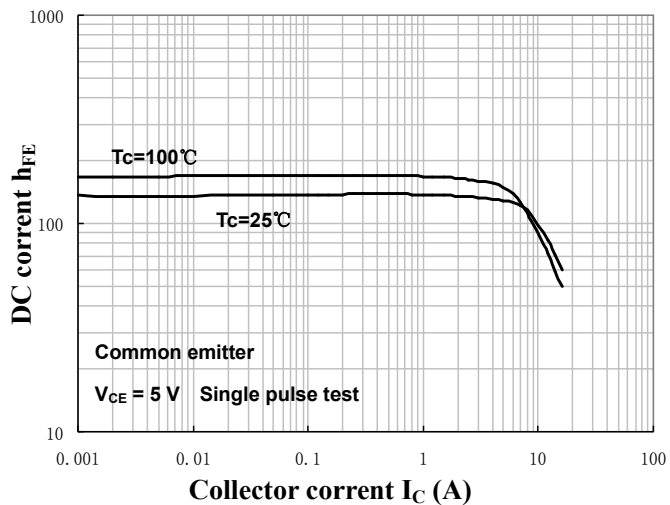

### Saturation Voltage

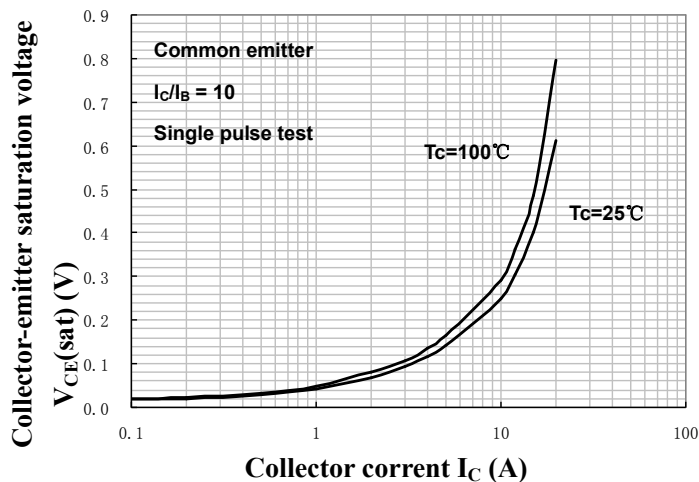

### Base-Emitter Voltage

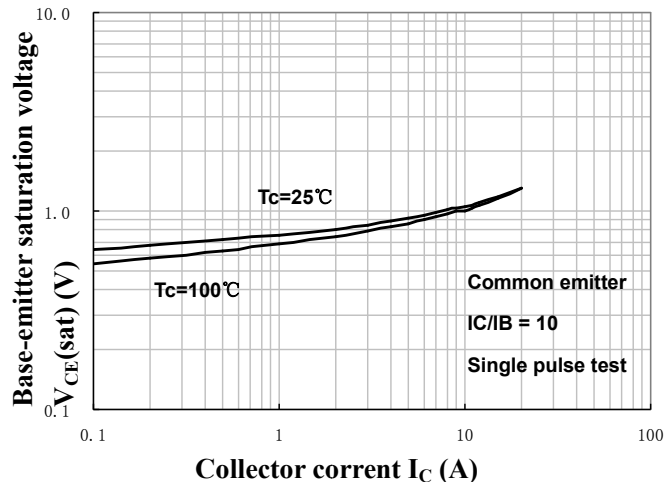

### Power Derating

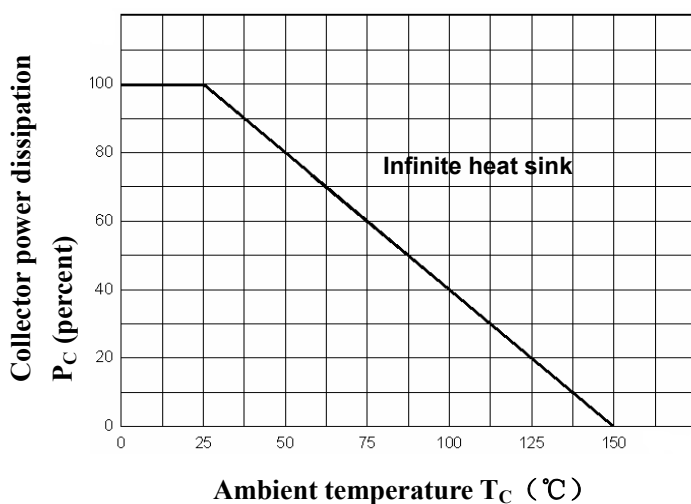

### Safe Operating Area

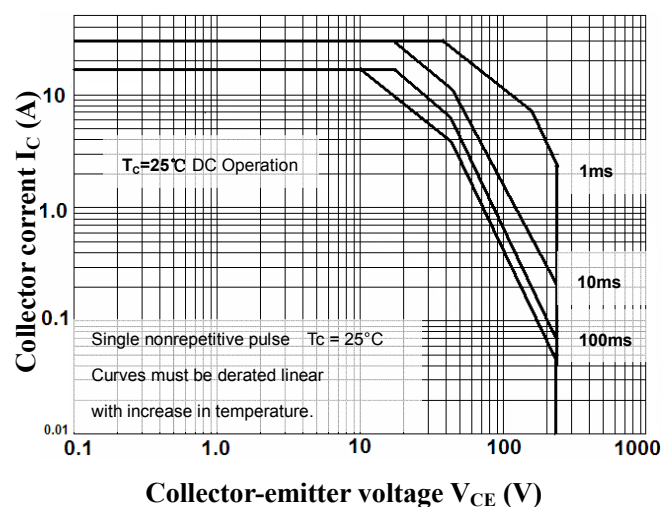



## 特征曲线 ELECTRICAL CHARACTERISTICS (2SC5200A curves)

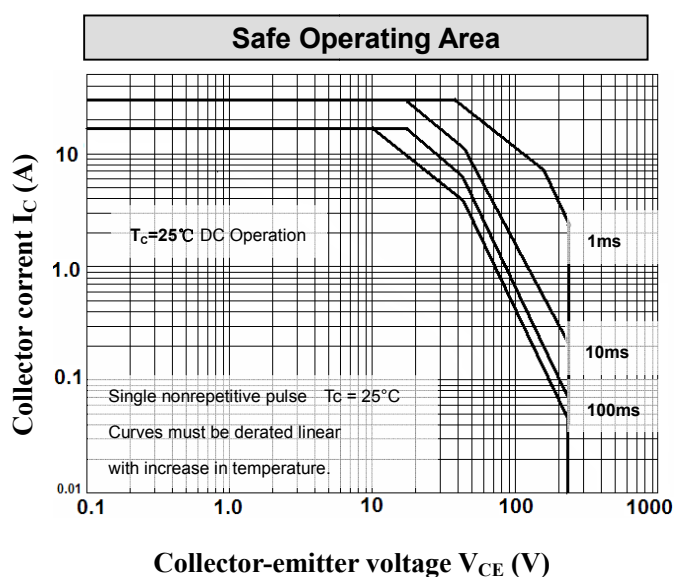
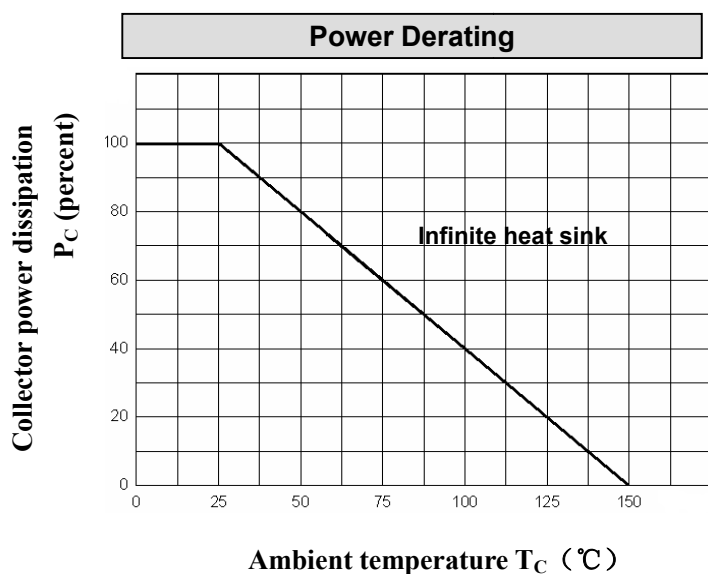
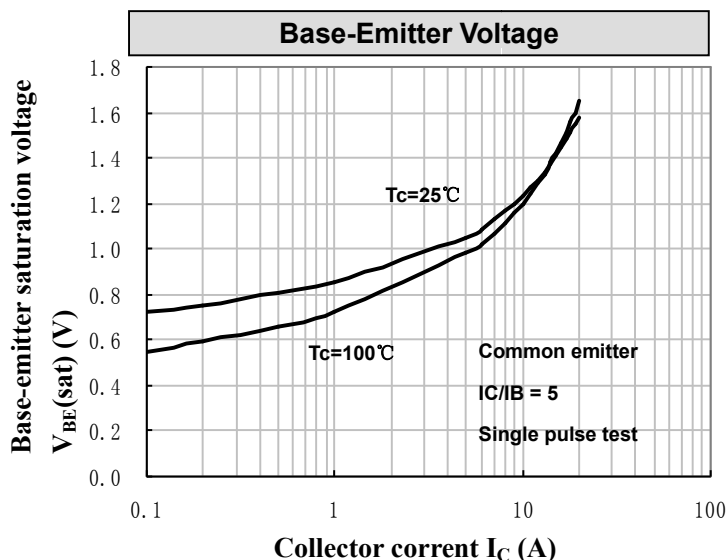
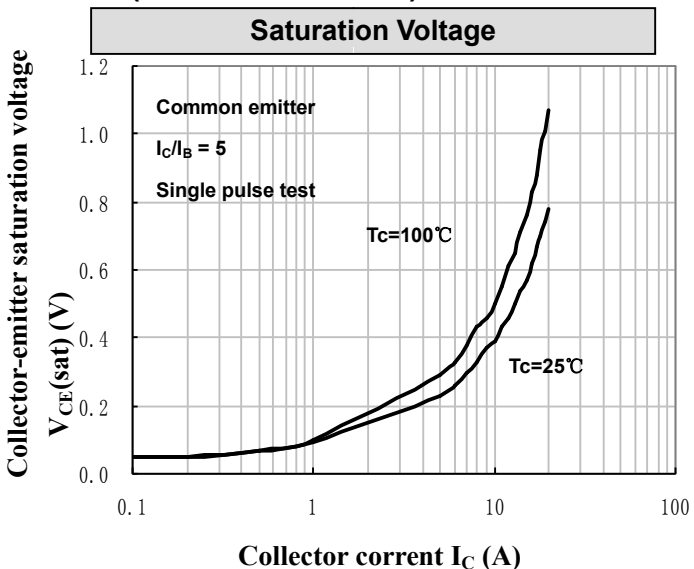
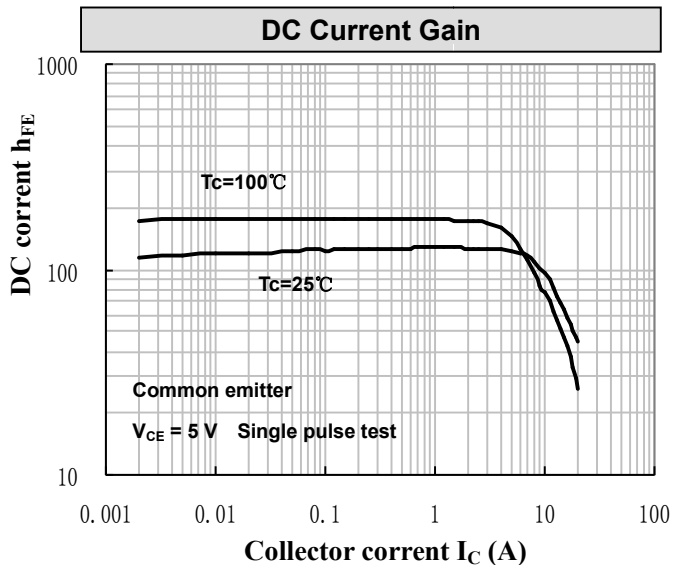



特征曲线 ELECTRICAL CHARACTERISTICS (2SC5200B curves)

Base-Emitter Voltage

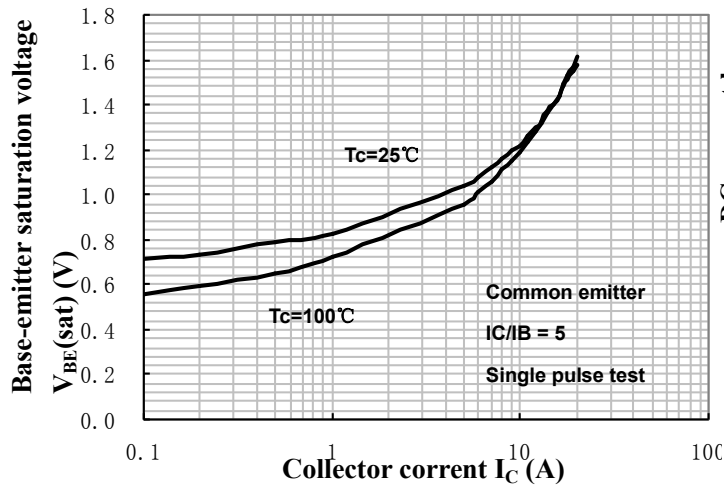

DC Current Gain

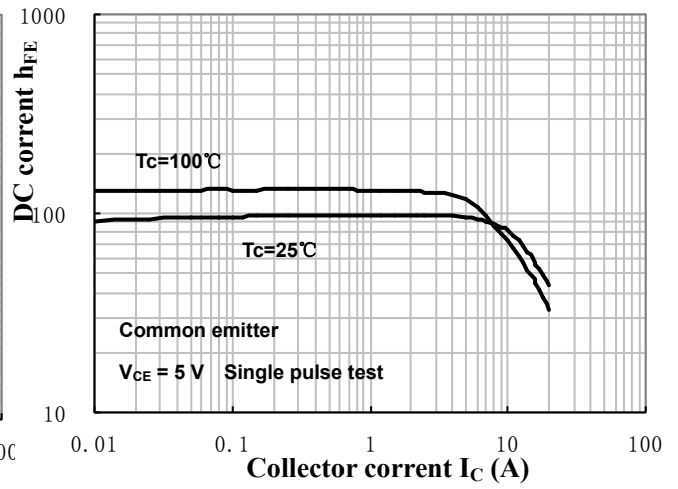

Saturation Voltage

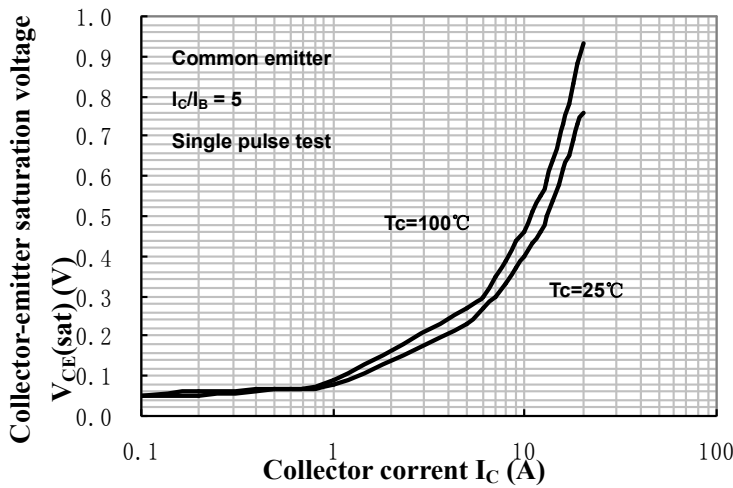

Power Derating

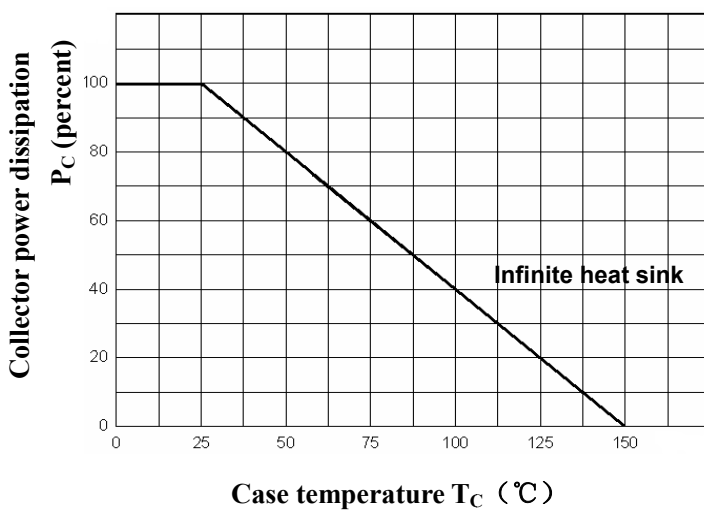

Safe Operating Area

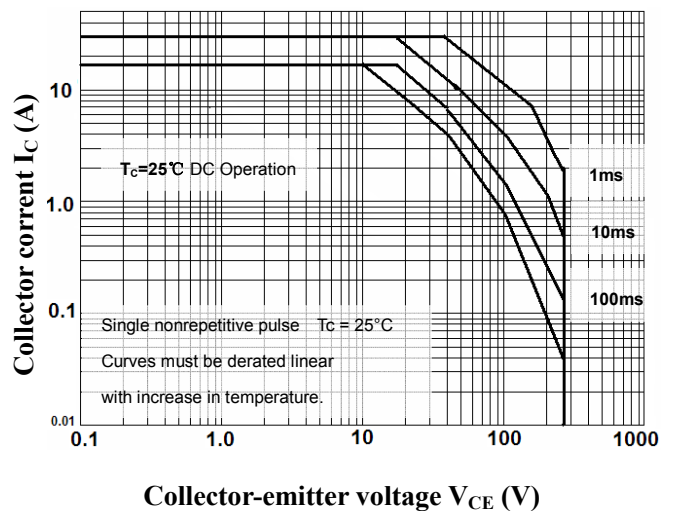



特征曲线 ELECTRICAL CHARACTERISTICS (2SC5200C curves)

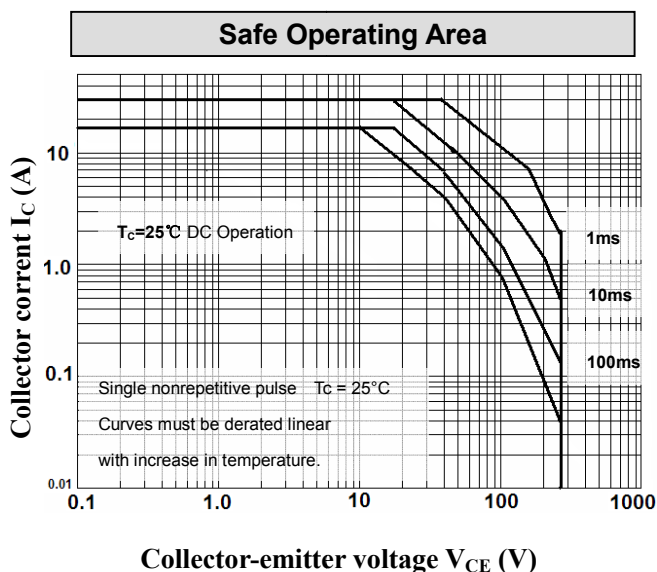
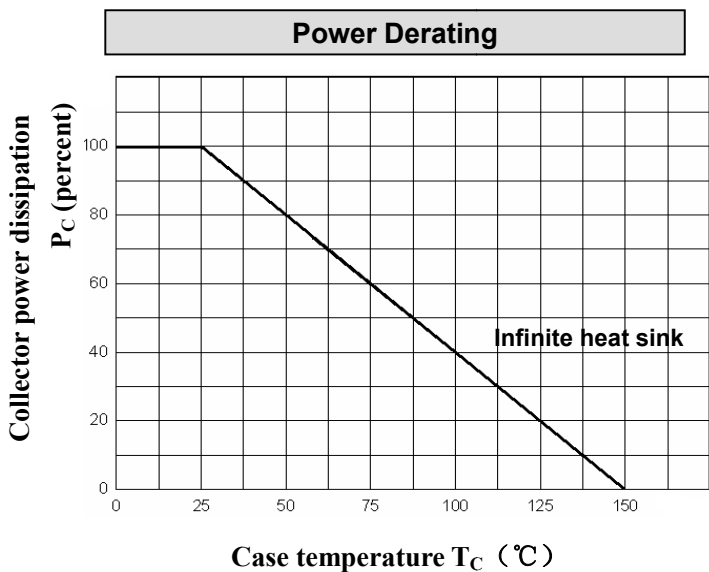
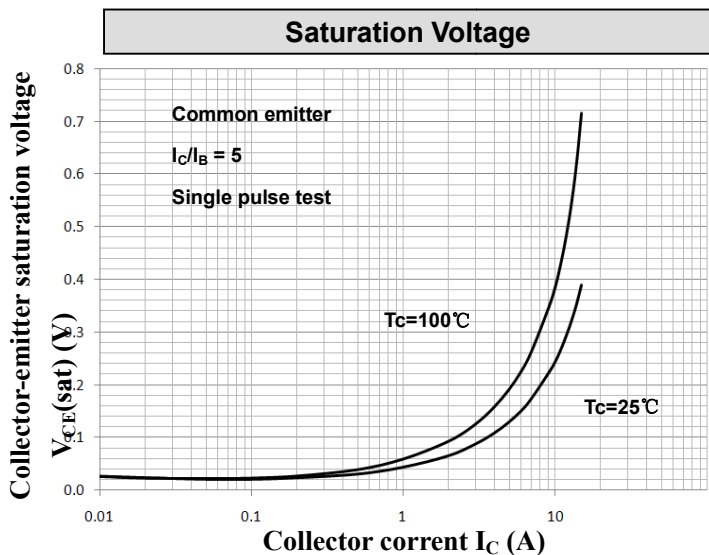
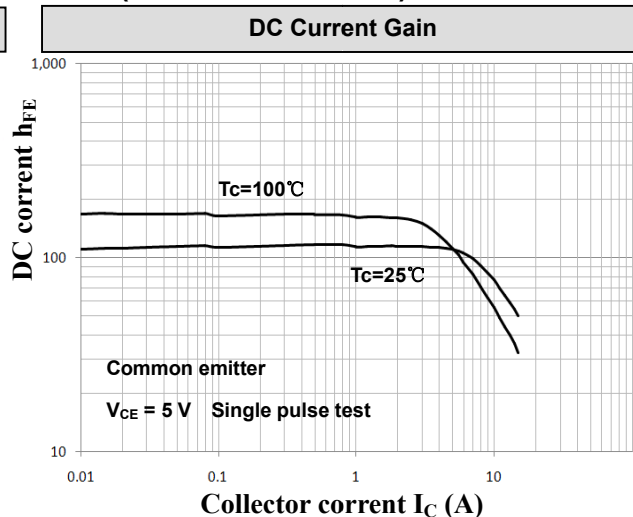
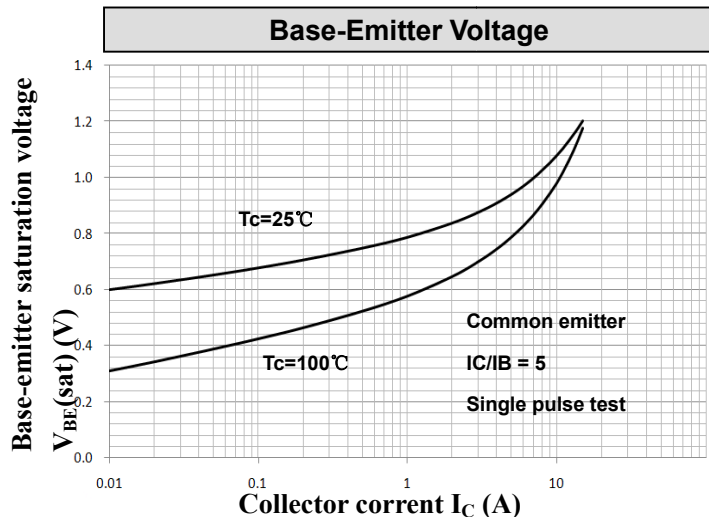



外形尺寸 PACKAGE MECHANICAL DATA  
TO-3PB

单位 Unit : mm

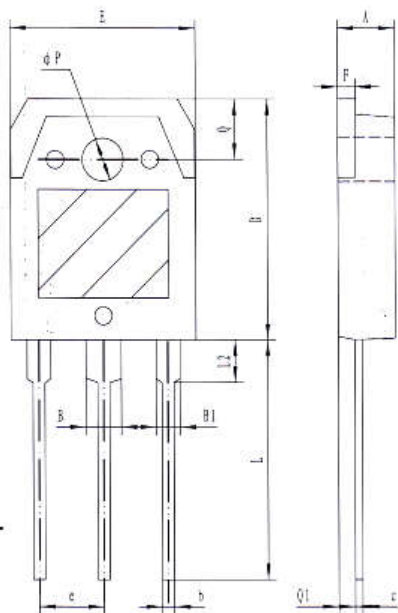

符号	尺寸 (mm)
A	4.60-5.00
B	2.90-3.20
B1	1.90-2.20
b	0.90-1.10
c	0.50-0.70
D	19.40-20.40
E	15.40-15.80
e	5.45(TYP)
F	1.40-1.60
L	19.50-20.50
L2	3.30-3.70
P	3.10-3.50
Q	4.90-5.10
Q1	1.30-1.50

外形尺寸 PACKAGE MECHANICAL DATA  
TO-3PL(T)

单位 Unit : mm

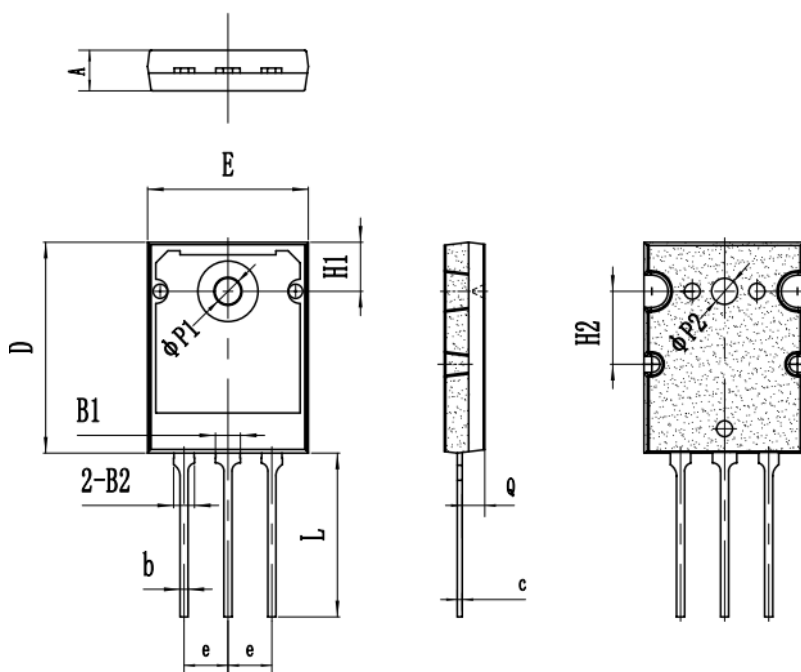

符号	尺寸 (mm)
A	4.70-5.30
B1	2.80-3.20
B2	2.30-2.70
b	0.80-1.25
c	0.59-0.61
D	25.5-26.5
E	19.5-20.5
e	5.45(typ)
H1	6.00-6.10
H2	8.95-9.05
L	20.0-20.4
Q	2.75-2.85
P1	3.45-3.55
P2	3.20-3.30



**注意事项**

1. 吉林华微电子股份有限公司的产品销售分为直销和销售代理，无论哪种方式，订货时请与公司核实。
2. 购买时请认清公司商标，如有疑问请与公司本部联系。
3. 在电路设计时请不要超过器件的绝对最大额定值，否则会影响整机的可靠性。
4. 本说明书如有版本变更不另外告知

**NOTE**

1. Jilin Sino-microelectronics co., Ltd sales its product either through direct sales or sales agent , thus, for customers, when ordering , please check with our company.
2. We strongly recommend customers check carefully on the trademark when buying our product, if there is any question, please don't be hesitate to contact us.
3. Please do not exceed the absolute maximum ratings of the device when circuit designing.
4. Jilin Sino-microelectronics co., Ltd reserves the right to make changes in this specification sheet and is subject to change without prior notice.

**联系方式****吉林华微电子股份有限公司**

公司地址：吉林省吉林市深圳街 99 号

邮编：132013

总机：86-432-64678411

传真：86-432-64665812

网址：[www.hwdz.com.cn](http://www.hwdz.com.cn)**市场营销部**

地址：吉林省吉林市深圳街 99 号

邮编：132013

电话：86-432-64675588

64675688

64678411

传真：86-432-4671533

**CONTACT****JILIN SINO-MICROELECTRONICS CO., LTD.**

ADD: No.99 Shenzhen Street, Jilin City, Jilin Province, China.

Post Code: 132013

Tel: 86-432-64678411

Fax: 86-432-64665812

Web Site: [www.hwdz.com.cn](http://www.hwdz.com.cn)**MARKET DEPARTMENT**

ADD: No.99 Shenzhen Street, Jilin City, Jilin Province, China.

Post Code: 132013

Tel: 86-432-64675588

64675688

64678411

Fax: 86-432-64671533

**附录 (Appendix) : 修订记录 (Revision History)**

日期 Date	旧版本 Last Rev.	新版本 New Rev.	修订内容 Description of Changes
2016-3-16		201603A	

