

Surface mount DIP Switch — Auto Placeable

Features

Optimized Mechanical Features

- Removable tape seal to withstand IR vapor phase or wave soldering temperatures, board washing
- Positive detent separate from contactor
- Low profile and medium height actuators available
- SPST configurations, 2 through 10 and 12 positions
- .686mm (.027") actuator travel
- Gull-wing and "J" lead terminal configurations

Optimized Contact System

- Redundant, wiping contact
- Contactor does not deflect during actuation

Premium Materials

- Gold plated contacts, solder coated terminals
- Copper alloy contactor
- High temperature materials (UL 94 V-0)

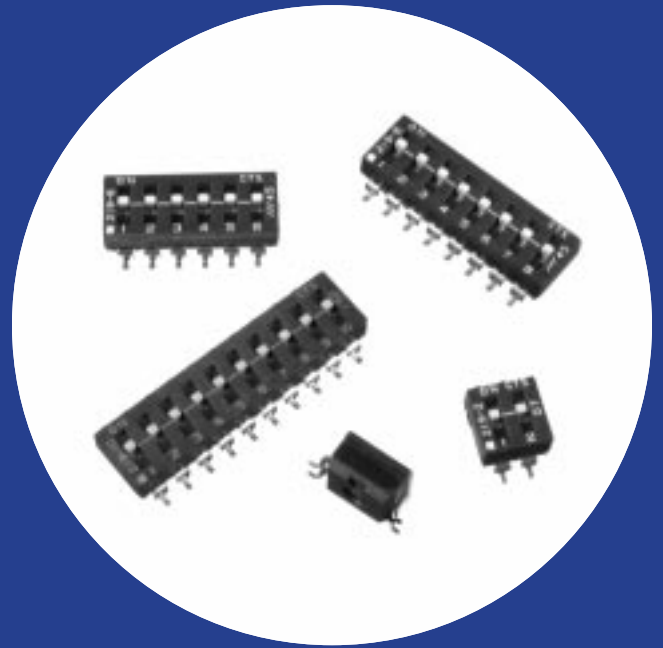

Electrical and Mechanical Specifications

Switch Function

Single pole single throw

Switch Contact Resistance

25 milliohms maximum initial
50 milliohms maximum at end of life

Insulation Resistance

1,000 megohms minimum between
insulated terminals

Dielectric Strength

500 VDC minimum for 1 minute

Nonswitching Rating

100 mA or 50 VDC

Switch Capacitance

5 pF maximum between adjacent closed switches

Temperature Range

-40°C to +85°C

Actuation Life

2,000 cycles switching 100 mA @ 20 VDC or
.1 mA @ 5 VDC (dry circuit)

Coplanarity

0.10mm (.004") maximum

Allowable Solder Time

IR and vapor phase - up to 60 seconds at 260°C
Wave - up to 6 seconds @ 260°C

Vibration

Per MIL-STD-202F, method 204D, condition B
(.065" or 15 G's between 10 HZ to 2K Hz) with no
contact inconsistencies greater than 1
microsecond.

Shock

Per MIL-STD-202F, method 213B, condition A
(50 G's) with no contact inconsistencies greater
than 1 microsecond.

Sealing

Bottom seal standard
Top tape seal optional

Marking

Special marking available consult CTS.

CTS SERIES 219 SMT CONTACT FEATURES

- 1. Value of Redundant (Bifurcated) Gold Plated Contacts:** Redundancy dramatically reduces the probability of contact failure while gold contact material provides the highest environmental protection, IMPROVING RELIABILITY.
- 2. Value of Wiping Contact Action:** Cleans contact area, IMPROVING RELIABILITY.
- 3. Value of Contactor Not Deflecting During Actuation:** Constant contact pressure eliminates overstressing contacts, IMPROVING RELIABILITY.
- 4. Value of Detent Separate from Contactor:** Separate detent allows optimization of nondeflecting contactor and detent designs, IMPROVING RELIABILITY.

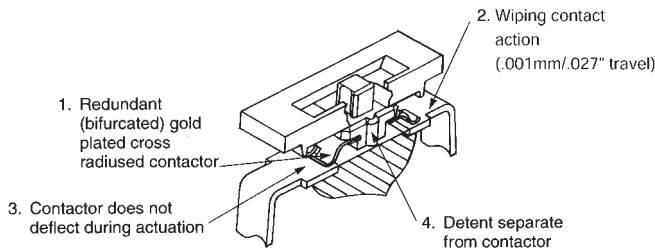

"A" Overall Dimension	No. of Switch Sections
6.55/.258	2
9.09/.358	3
11.63/.458	4
14.17/.558	5
16.71/.658	6
19.25/.758	7
21.79/.858	8
24.33/.958	9
26.87/1.058	10
31.95/1.258	12

CTS 219-XX

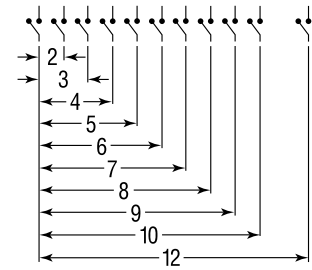

*For "J" bend terminal configurations, add the letter "J" to part number ie 219-2MSTJ or 219-2LPSTJ.

Gull Wing Terminals Medium Height Actuator

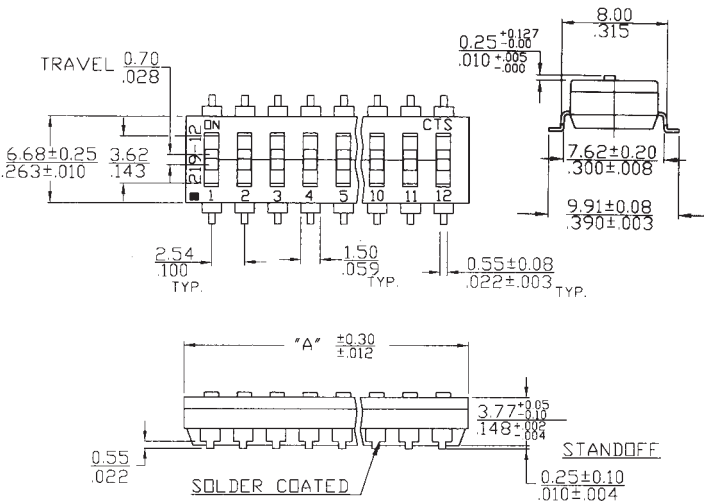

Gull Wing Surface Mount Pad Layouts

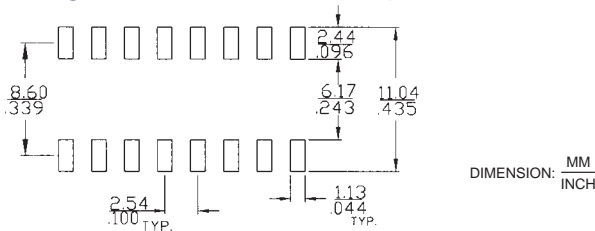

"J" Lead Terminals Low Profile Actuator

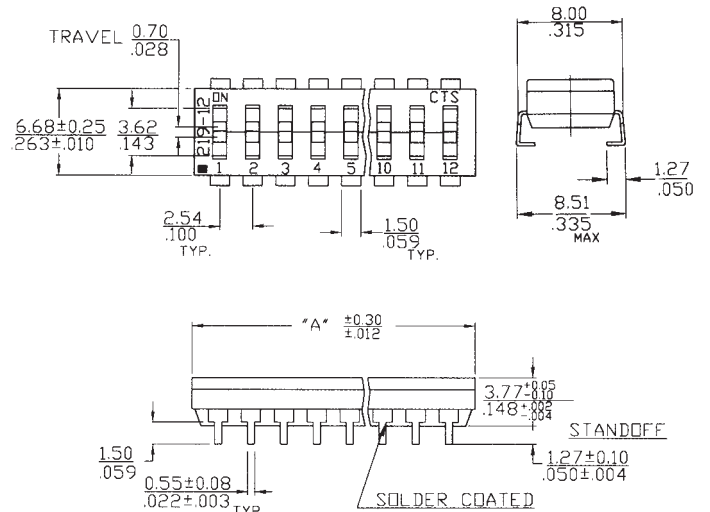

"J" Lead Surface Mount Pad Layouts

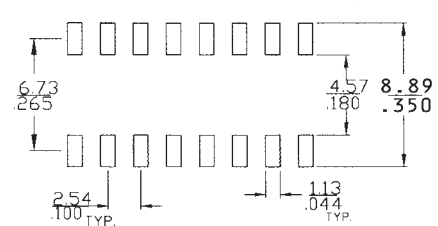

Part Number Code For Ordering

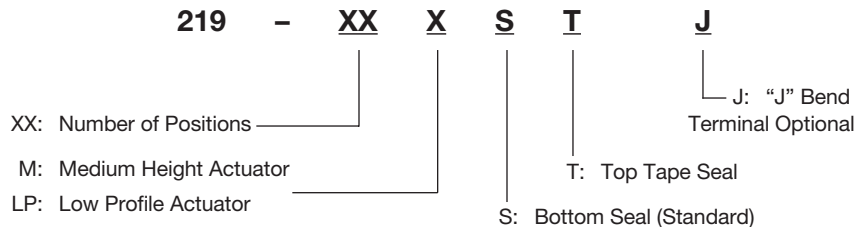

Order From:

CTS CORPORATION, RESISTOR/ELECTROCOMPONENTS / 1601 Mishawaka Street / Elkhart, Indiana 46514
North America Toll Free (888) 287-4690 / (219) 296-6700 / FAX: (219) 293-1240 <http://www.ctscorp.com>

CTS COMPONENTS TAIWAN, LTD. / 7, Central 6th Road (Chung Liu Road) / P.O. Box 26-20
Kaohsiung Export Processing Zone / Kaohsiung, Taiwan, Rep. of China
(07) 8216145 / FAX: (07) 8417642.8110040