

TGA2501-GSG

2.8 Watt 6-18 GHz Power Amplifier

Applications

- X- and Ku-band Point-to-Point Radio
- ECCM



Product Features

- Frequency Range: 6 - 18 GHz
- Saturated Output Power: 34.5 dBm
- Small Signal Gain: 26 dB
- Bias: $V_d = 8\text{ V}$, $I_{dq} = 1.2\text{ A}$, $V_g = -0.6\text{ V}$ typical

General Description

The TriQuint TGA2501-GSG provides 26 dB of small signal gain and 2.8 W of output power across 6-18 GHz. The TGA2501-GSG is designed using TriQuint's proven standard 0.25 μm gate pHEMT production process.

The TGA2501-GSG features low loss ground-signal-ground (GSG) RF transitions designed to interface with a coplanar waveguide multilayer board.

Fully matched to 50 ohms and with integrated DC blocking capacitors on both I/O ports, the TGA2501-GSG is ideally suited to support both commercial and defense related applications

Lead-free and RoHS compliant.

Functional Block Diagram

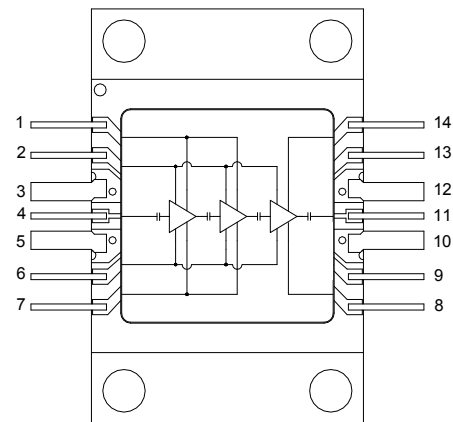

Pin Configuration

Pin #	Symbol
1,7,8,14	V_d
2	V_g
3,5,10,12	Gnd
4	RF In
6,9,13	N/C
11	RF Out

Ordering Information

Part No.	ECCN	Description
TGA2501-GSG	3A001.b.2.c	X-, Ku-band Power Amplifier

TGA2501-GSG

2.8 Watt 6-18 GHz Power Amplifier



Specifications

Absolute Maximum Ratings

Parameter	Rating
Drain Voltage, Vd	9 V
Gate Voltage, Vg	-5 to 0 V
Drain Current, Id	2 A
Gate Current range, Ig	-18 to 18 mA
RF Input Power, CW, 50Ω, T = 25°C	18 dBm
Channel Temperature, Tch	200°C
Mounting Temperature (30 Seconds)	260 °C
Storage Temperature	-40 to 150 °C

Operation of this device outside the parameter ranges given above may cause permanent damage. These are stress ratings only, and functional operation of the device at these conditions is not implied.

Recommended Operating Conditions

Parameter	Min	Typ	Max	Units
Vd		8		V
Idq (no RF drive)		1.2		A
Id_drive (under RF drive)		1.5		A
Vg		-0.6		V

Electrical specifications are measured at specified test conditions. Specifications are not guaranteed over all recommended operating conditions

Electrical Specifications

Test conditions unless otherwise noted: 25°C, Vd = 8 V, Idq = 1.2 A, Vg = -0.6 V, CW, typical

Parameter	Min	Typ	Max	Units
Operational Frequency Range	6		18	GHz
Small Signal Gain		26		dB
Output Power @ Saturation		34.5		dBm
Power-added Efficiency @ Saturation		23		%
Power Temperature Coefficient		-0.01		dB/°C

Specifications (cont'd)

Thermal and Reliability Information

Parameter	Condition	Rating
Channel Temperature (Tch), Median Lifetime (Tm), Thermal Resistance*, no RF Drive	Tbase = 85 °C, Vd = 8V, Idq = 0.8 A, Pdiss = 6.4 W, CW	Tch = 148 °C Tm = 1.0E+6 Hours θJC = 9.8 °C/W
Channel Temperature (Tch), Median Lifetime (Tm), Thermal Resistance*, under RF Drive	Tbase = 85 °C, Vd = 8V, Id = 1.4 A, Pout = 34.5 dBm, Pdiss = 8.4 W, CW	Tch = 167 °C Tm = 2.7E+5 Hours θJC = 9.8 °C/W

* Thermal Resistance, θJC, measured to center bottom of package

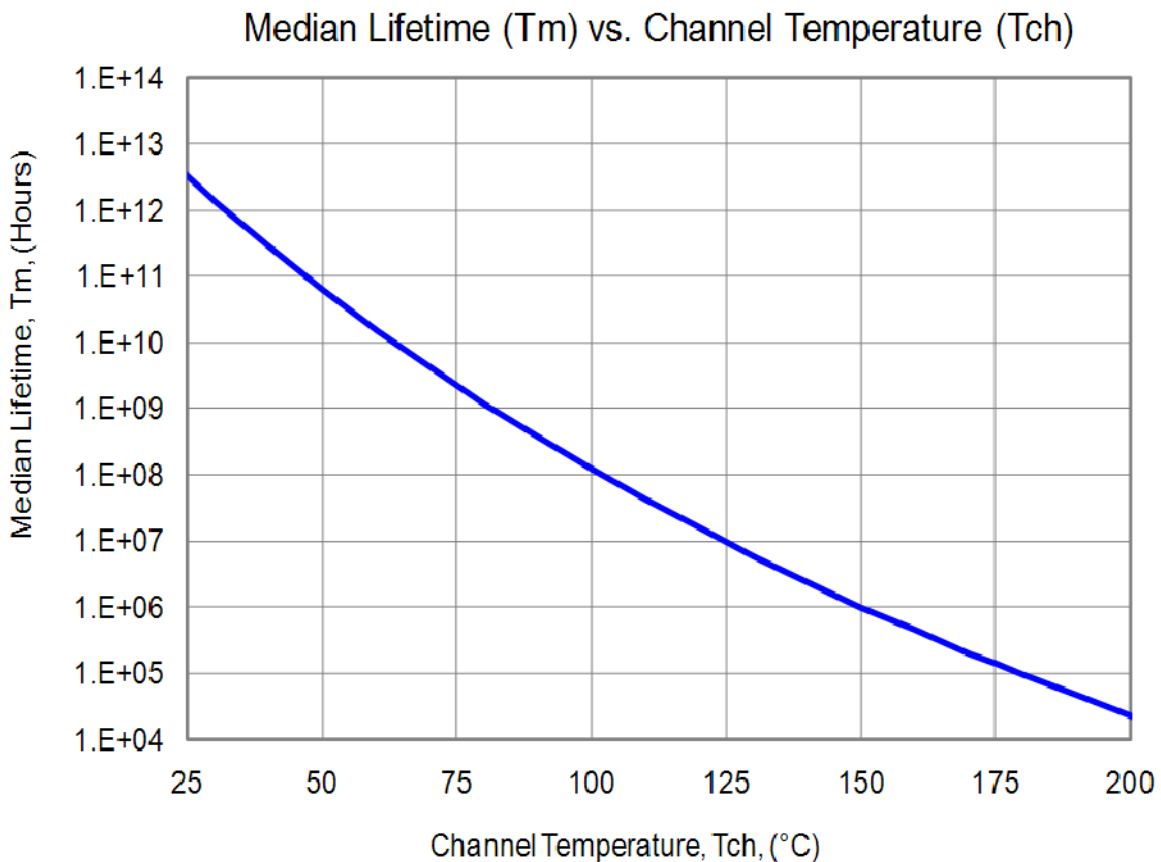

TGA2501-GSG

2.8 Watt 6-18 GHz Power Amplifier



Typical Performance

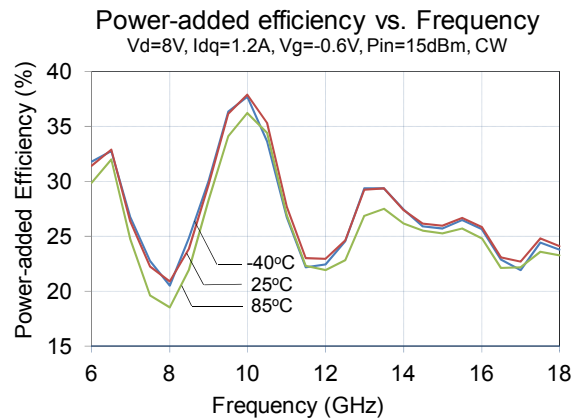
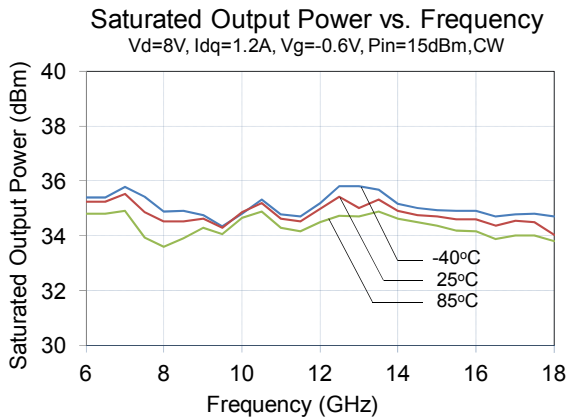
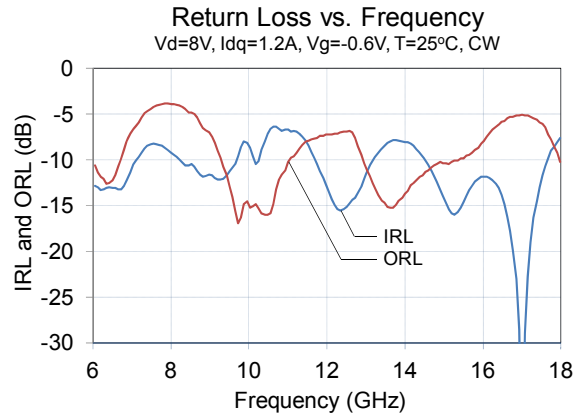
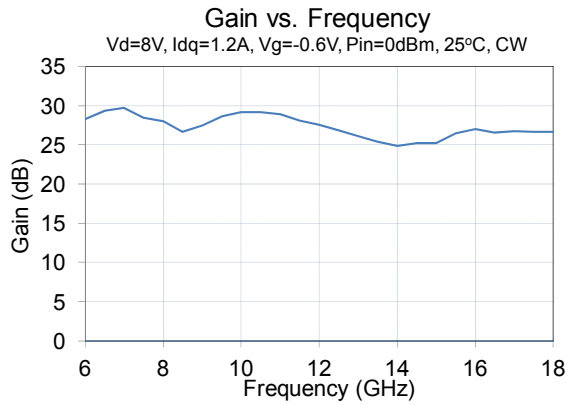

TGA2501-GSG

2.8 Watt 6-18 GHz Power Amplifier



Typical Performance

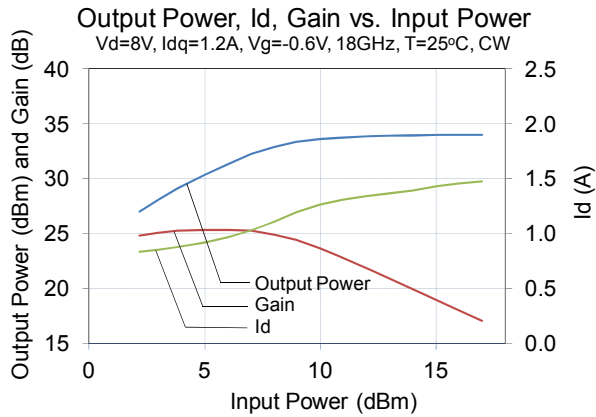
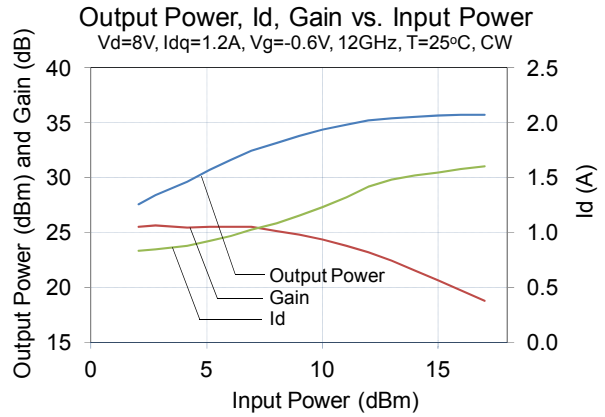
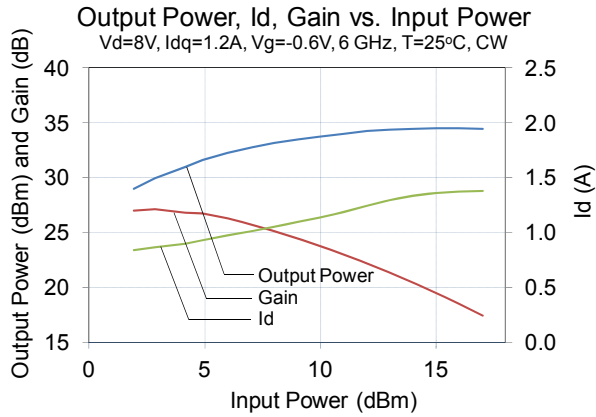

TGA2501-GSG

2.8 Watt 6-18 GHz Power Amplifier



Application Circuit

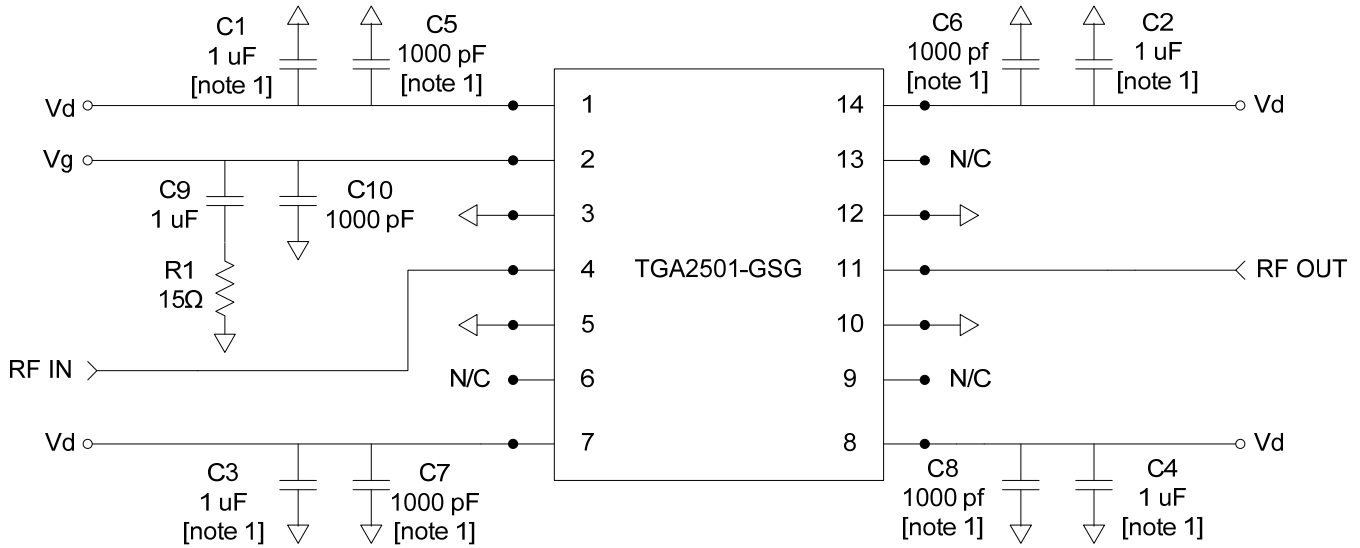

Note 1: Remove cap for pulsed drain operation

Bias-up Procedure	Bias-down Procedure
Turn Vg to -2 V	Turn off RF signal
Turn Vd to 8 V	Reduce Vg to -2 V. Ensure Id ~ 0 mA
Adjust Vg more positive until quiescent Id is 1.2 A. This will be Vg ~ -0.6 V typical	Turn Vd to 0 V
Apply RF signal	Turn Vg to 0 V

TGA2501-GSG

2.8 Watt 6-18 GHz Power Amplifier

Pin Description

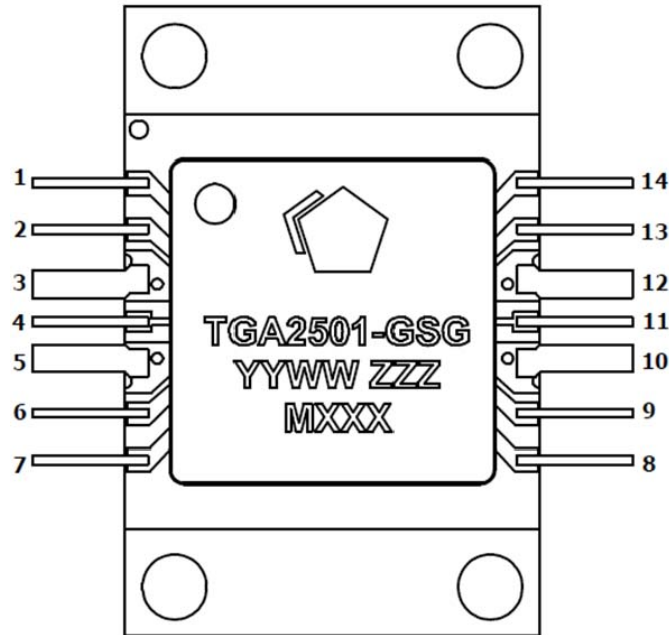

Pin #	Symbol	Description
1,7,8,14	Vd	Drain voltage. Bias network is required; all Drain voltage pins must be connected and biased
2	Vg	Gate voltage. Bias network is required
3,5,10,12	Gnd	Connect to Ground
4	RF In	Input, matched to 50Ω
6,9,13	N/C	No internal connection; may be left open
11	RF Out	Output, matched to 50Ω

Note: See Application Circuit on page 6 as an example

TGA2501-GSG

2.8 Watt 6-18 GHz Power Amplifier

Evaluation Board Layout

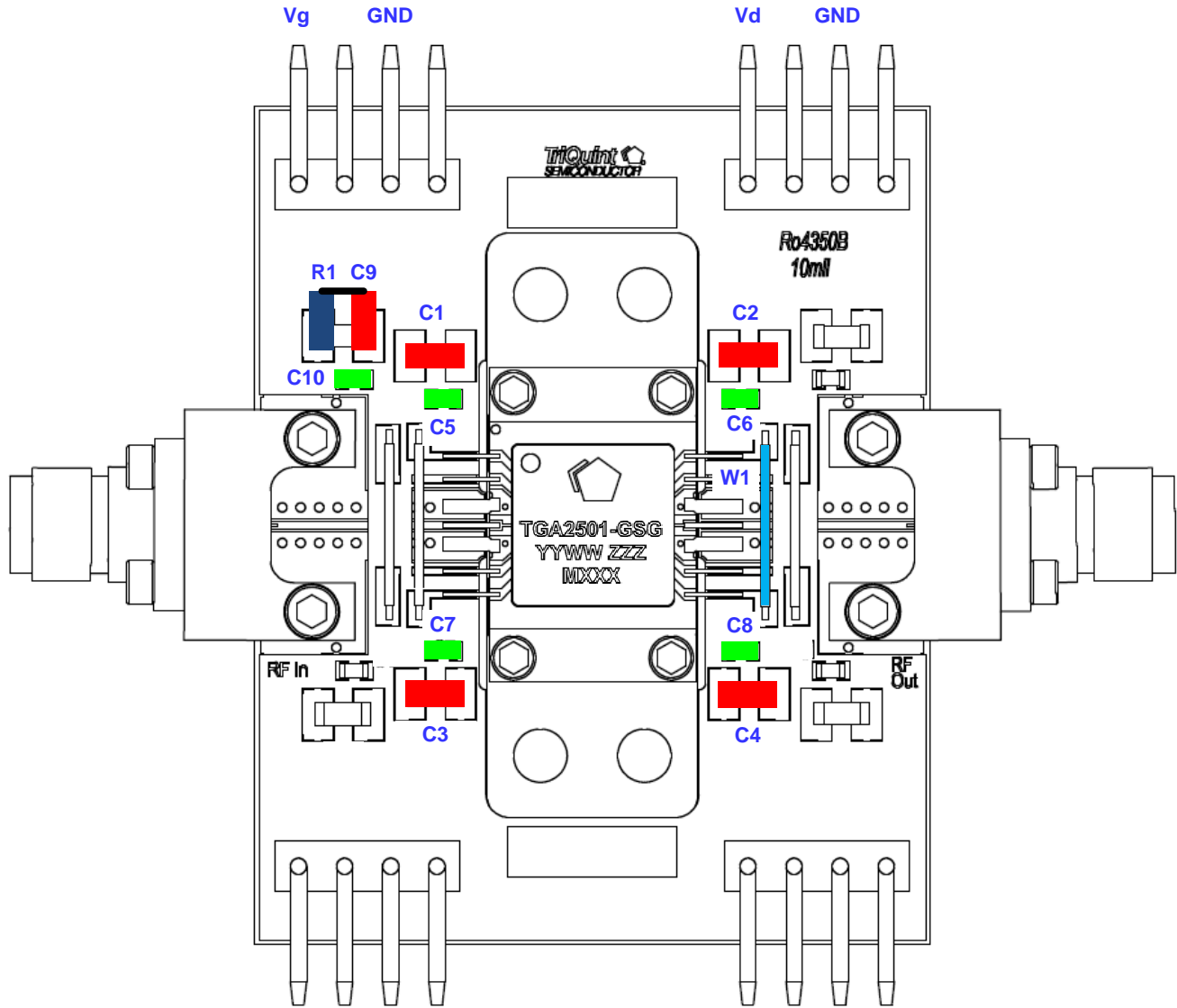

Bill of Material

Ref Des	Value	Description	Manufacturer	Part Number
C1-C4,C9	1 uF	Cap, 1206, 50V, 10%, XR7	Panasonic	ECJ-3YX1H105K
C5-C8,C10	1000 pF	Cap, 0603, 50V, 10%, XR7	Panasonic	ECJ-ZEB1H102K
R1	15Ω	Res, 1206	Vishay/Dale	CRCW120615R0FKEA
W1		Jumper, 20 gauge wire	Various	

TGA2501-GSG

2.8 Watt 6-18 GHz Power Amplifier

Mechanical Information

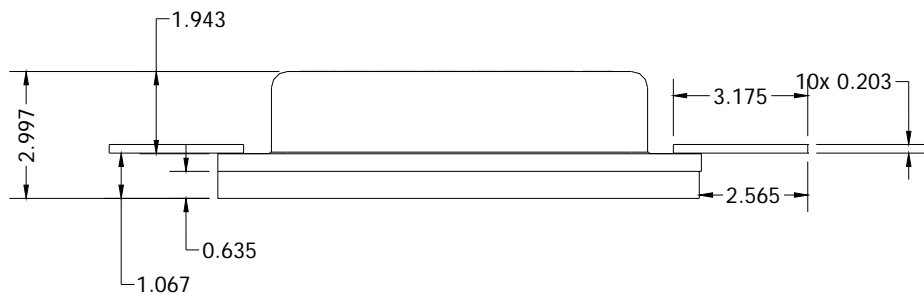
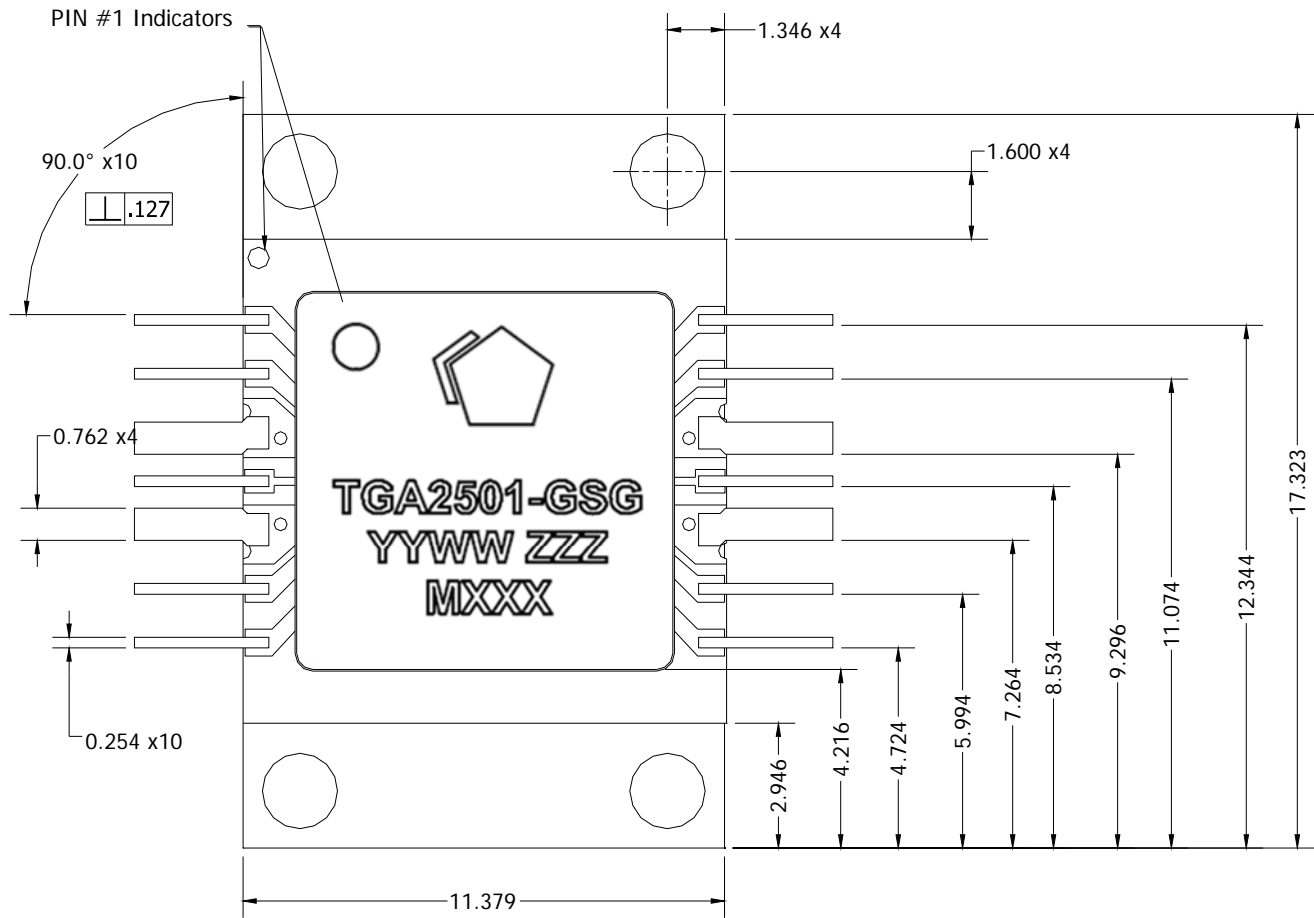

Unit: millimeters
 Part marking:
YY assembly lot start year
WW assembly lot start week
ZZZ part serial number

TGA2501-GSG

2.8 Watt 6-18 GHz Power Amplifier

Product Compliance Information

ESD Information



Caution! ESD-Sensitive Device

ESD rating: TBD
Value: Passes \geq TBD V min.
Test: Human Body Model (HBM)
Standard: JEDEC Standard JESD22-A114

Solderability

This part is compliant with EU 2002/95/EC RoHS directive (Restrictions on the Use of Certain Hazardous Substances in Electrical and Electronic Equipment).

This product also has the following attributes:

- Lead Free
- Halogen Free (Chlorine, Bromine)
- Antimony Free
- TBBP-A (C₁₅H₁₂Br₄O₂) Free
- PFOS Free

ECCN

US Department of Commerce: 3A001.b.2.c

Assembly Notes

1. Clean the board or module with alcohol. Allow it to fully dry
2. Nylock screws are recommended for mounting the TGA2501-GSG to the board
3. To improve the thermal and RF performance, we recommend a heat sink attached to the bottom of the board and/or apply thermal compound to the bottom of the TGA2501-GSG
4. Apply solder to each pin of the TGA2501-GSG.
5. Clean the assembly with alcohol.

TGA2501-GSG

2.8 Watt 6-18 GHz Power Amplifier



Contact Information

For the latest specifications, additional product information, worldwide sales and distribution locations, and information about TriQuint:

Web: www.triquint.com **Tel:** +1.972.994.8465
Email: info-products@tqs.com **Fax:** +1.972.994.8504

For technical questions and application information:

Important Notice

The information contained herein is believed to be reliable. TriQuint makes no warranties regarding the information contained herein. TriQuint assumes no responsibility or liability whatsoever for any of the information contained herein. TriQuint assumes no responsibility or liability whatsoever for the use of the information contained herein. The information contained herein is provided "AS IS, WHERE IS" and with all faults, and the entire risk associated with such information is entirely with the user. All information contained herein is subject to change without notice. Customers should obtain and verify the latest relevant information before placing orders for TriQuint products. The information contained herein or any use of such information does not grant, explicitly or implicitly, to any party any patent rights, licenses, or any other intellectual property rights, whether with regard to such information itself or anything described by such information.

TriQuint products are not warranted or authorized for use as critical components in medical, life-saving, or life-sustaining applications, or other applications where a failure would reasonably be expected to cause severe personal injury or death.