

envelope \varnothing 20.5mm

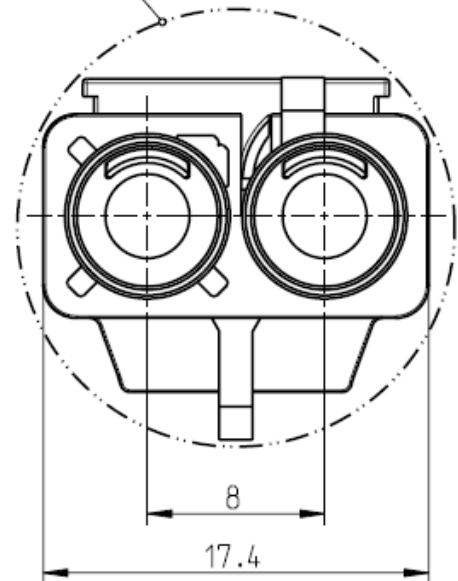
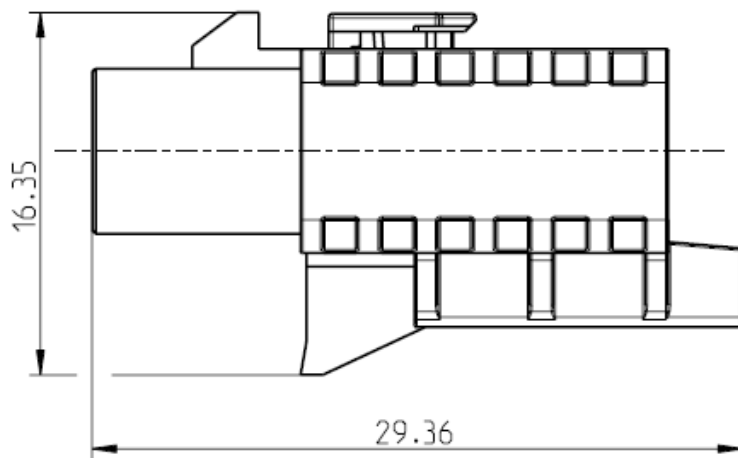

All dimensions are in mm; tolerances according to ISO 2768 m-H
 Y = Part number has to be accomplished by codification

Interface and coding

According to
 Clips slot acc. To

DIN 72594-1, ISO 20860-1
 USCAR 18 rev3 app.C

Material and plating

Connector parts

Housing
 Secondary lock

Material

PBT
 PBT

Dieses Dokument ist urheberrechtlich geschützt • This document is protected by copyright • Rosenberger Hochfrequenztechnik GmbH & Co. KG

RF_35/05.10/6.0

Mechanical data

Mating cycles	≥ 25
Retention force latch	≥ 110 N
Retention force primary lock	≥ 80 N
Retention force secondary lock	≥ 60 N
Coding efficiency	≥ 40 N

Environmental data

Temperature range	-40°C to +105°C
Thermal shock	DIN 72594-2 clause 8.2
Temperature and humidity	DIN 72594-2 clause 8.3
Vibration and mechanical shock	DIN 72594-2 clause 8.1
Dry heat	DIN 72594-2 clause 8.4
RoHS	compliant

Application

Applicable e.g. for following connectors: 59S10E-1xx *; 59S17E-1xx *; 59S10L-1xx *; 59S100-1xx *; 59S16A-1xx *



**-xx for all available cable variations*

Packing

Standard 500 pcs in box
Weight 2.5 g/pce

















Dieses Dokument ist urheberrechtlich geschützt • This document is protected by copyright • Rosenberger Hochfrequenztechnik GmbH & Co. KG

RF_35/05.10/6.0

Coding

Part Number has to be accomplished by codification

Coding	Color	RAL	Part-Number
 A	black	sim. 9005	59Z120-C00-A
 B	white	sim. 9001	59Z120-C00-B
 C	blue	sim. 5005	59Z120-C00-C
 D	bordeauxviolet	sim. 4004	59Z120-C00-D
 E	green	sim. 6002	59Z120-C00-E
 F	brown	sim. 8011	59Z120-C00-F
 G	grey	sim. 7031	59Z120-C00-G
 H	violet	sim. 4003	59Z120-C00-H
 I	beige	sim. 1001	59Z120-C00-I
 K	curry	sim. 1027	59Z120-C00-K
 L	carmine red	sim. 3002	59Z120-C00-L
 M	pastel orange	sim. 2003	59Z120-C00-M
 N	pastel green	sim.6019	59Z120-C00-N
 Z	waterblue	sim. 5021	59Z120-C00-Z
	traffic purple	sim. 4006	secondary lock

Change History

Rev.	Date	Change
b00	06.03.15	- Changed applicable connectors from jack to plug - Packing 500 pcs in box

While the information has been carefully compiled to the best of our knowledge, nothing is intended as representation or warranty on our part and no statement herein shall be construed as recommendation to infringe existing patents. In the effort to improve our products, we reserve the right to make changes judged to be necessary.

Draft	Date	Approved	Date	Rev.	Engineering change number	Name	Date
Bernhard Huber	01.07.13	C. Anfang	02.07.15	b00	15-0268	P. Schroeder	02.07.15