



## Glass Passivated Single Phase Bridge Rectifiers

**Reverse Voltage** 200 to 1000V  
**Forward Current** 35 Amp

### Features

- Glass passivated die construction
- Integrally molded heatsink provides Very low thermal resistance for Maximum heat dissipation
- The plastic material used carries UL flammability recognition 94V-0
- High surge current capability
- High temperature soldering guaranteed: 260°C /10 seconds, 0.375" (9.5mm) lead length, 5lbs. (2.3kg) tension

### Mechanical Data

**Case:** Molded plastic case  
**Terminals:** Plated leads solderable per MIL-STD-750, Method 2026  
**Polarity:** Marked on Body  
**Mounting Position:** Any

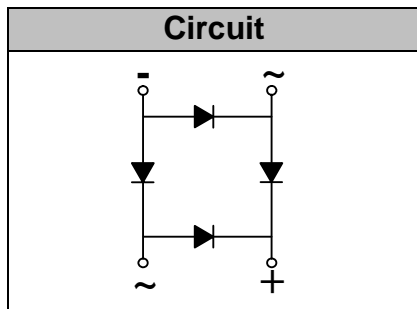

### Module Type

TYPE	VRRM	VRSM
GBPC3502A	200V	300V
GBPC3504A	400V	500V
GBPC3506A	600V	700V
GBPC3508A	800V	900V
GBPC3510A	1000V	1100V

### Maximum Ratings and Thermal Characteristics (TA = 25°C unless otherwise noted)

Symbol	Conditions	Values	Units
IF(AV)	Maximum average forward output rectified current Tc =55°C	35	A
IFSM	Peak forward surge current single half sine-wave superimposed on rated load (JEDEC Method)	400	A
i <sup>2</sup> t	Rating for fusing (t<8.3ms)	660	A <sup>2</sup> s
Visol	a.c.50HZ;r.m.s.;1min	2500	V
RθJC	Maximum thermal resistance <sup>(1)</sup>	1.2	°C/W
Tj, TSTG	Operating Junction and storage temperature range	-55 to +150	°C
Weight	Approximate Weight	15	g

### Electrical Characteristics (TA = 25°C unless otherwise noted)

Symbol	Conditions	Values	Units
VF	Maximum Instantaneous Forward Voltage per leg IFM =17.5A	1.1	V
IR	Maximum DC reverse current at rated DC blocking voltage per leg TA = 25°C TA = 125°C	5.0 500	µA

Notes: (1) Unit case mounted on Al plate heatsink  
 (2) Recommended mounting position is to bolt down on heatsink with silicone thermal compound for maximum heat transfer with M5 screw

## Performance Curves

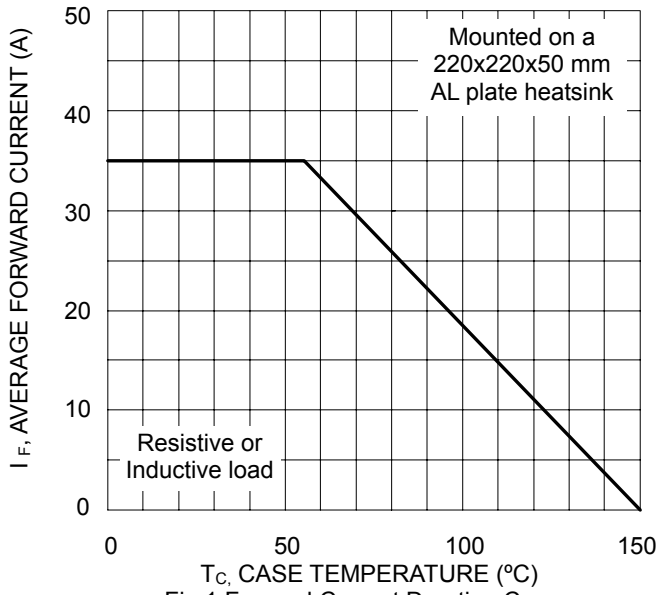

Fig.1 Forward Current Derating Curve

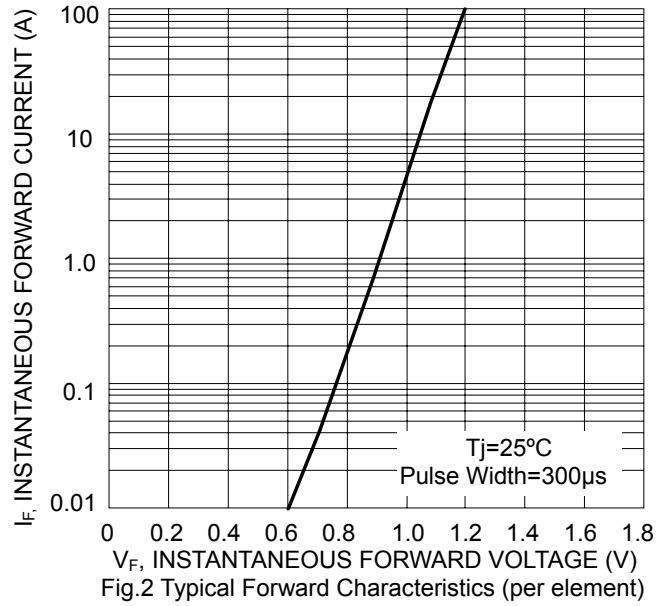

Fig.2 Typical Forward Characteristics (per element)

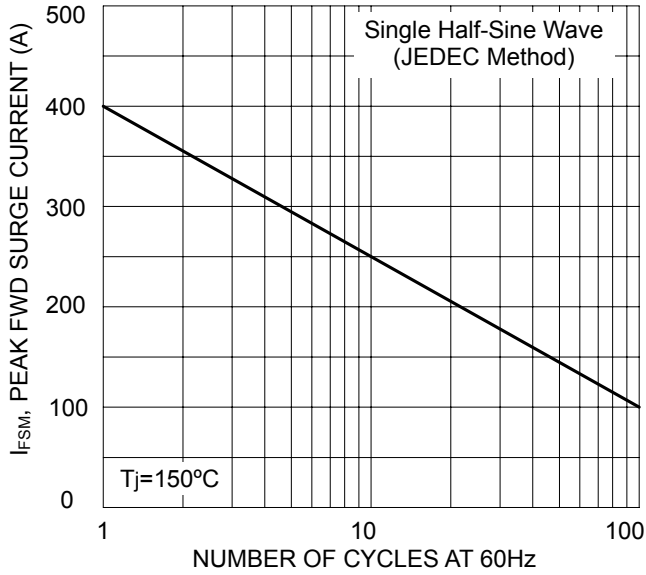

Fig.3 Max Non-Repetitive Surge Current

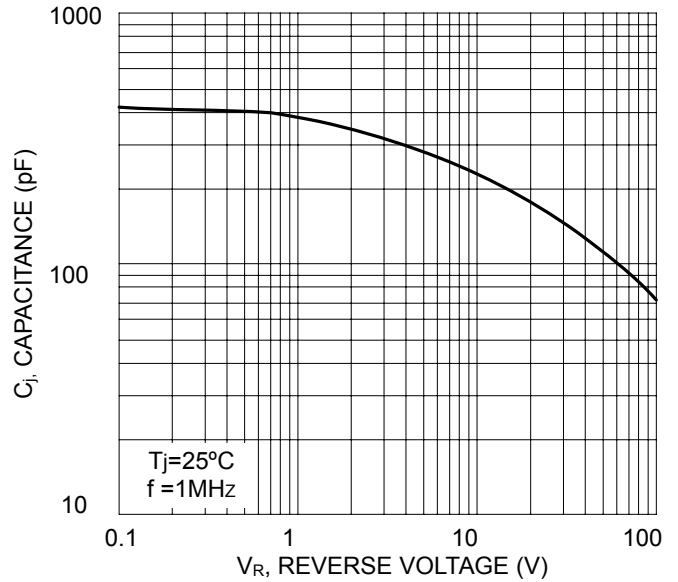

Fig.4 Typical Junction Capacitance (per element)

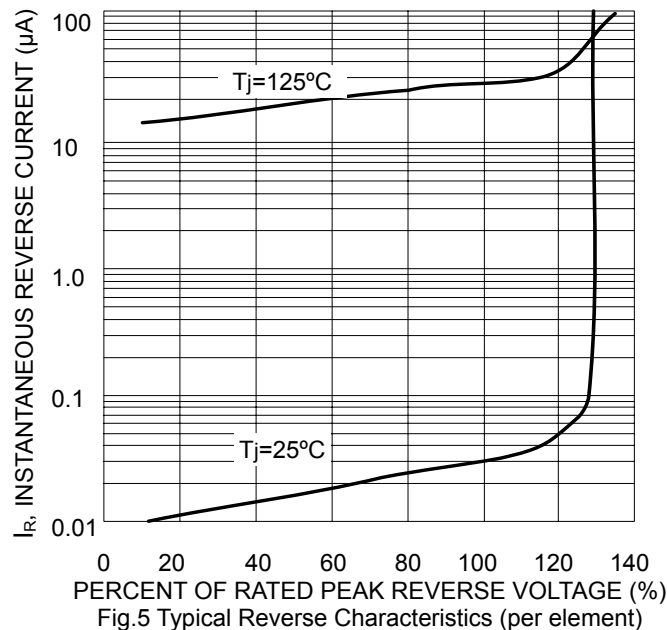
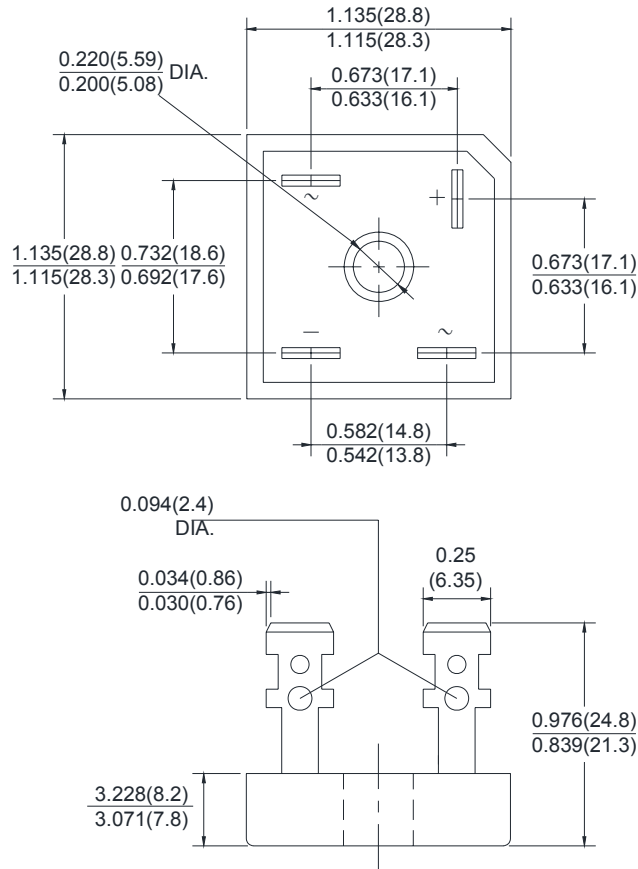

Fig.5 Typical Reverse Characteristics (per element)

## Package Outline Information

### CASE: GBPC-A



Dimensions in (inches) mm