

VCS3 series 1.8, 2.5, 3.3 volt CMOS Oscillator



VCS3 Crystal Oscillator

Features

- Quick delivery
- CMOS output
- 3.2mm x 2.5mm x 1.2 mm
- Output frequencies to 200.00 MHz
- Tri-state output for board test and debug
- -10/70 or -40/85°C operating temperature
- Gold over nickel contact pads
- Hermetically sealed ceramic SMD package
- Product is compliant to RoHS directive  and fully compatible with lead free assembly

Applications

- SONET/SDH/DWDM
- Ethernet, Gigabit Ethernet
- Storage Area Network
- Digital Video
- Broadband Access
- Microprocessors/DSP/FPGA

Description

Vectron's VCS3 Crystal Oscillator (XO) is quartz stabilized square wave generator with a CMOS output, operating from a 1.8, 2.5 or 3.3 volt supply.

The VCS3 utilized a high performance, low frequency quartz resonator followed by a custom ASIC to synthesize the output frequency.

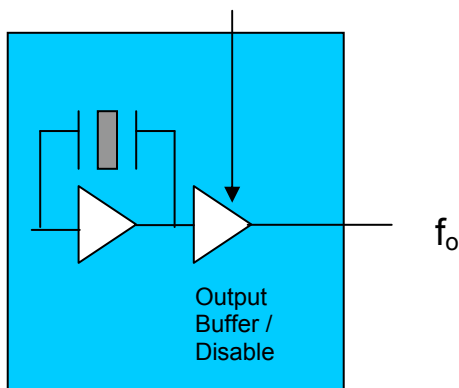

Table 1. Electrical Performance, 3.3V option					
Parameter	Symbol	Min	Typical	Maximum	Units
Frequency	f_O	1.0		200.000	MHz
Operating Supply Voltage ¹	V_{DD}	2.97	3.3	3.63	V
Absolute Maximum Operating Voltage		-0.5		5.0	V
Supply Current, Output Enabled	I_{DD}				mA
<30 MHz				10	
30.01 to 75 MHz				15	
75.01 to 133 MHz				20	
133.01 to 200 MHz				25	
Supply Current, Output disabled	I_{DD}			15	uA
Output Logic Levels					
Output Logic High ²	V_{OH}	$0.9 \cdot V_{DD}$		$0.1 \cdot V_{DD}$	V
Output Logic Low ²	V_{OL}				V
Output Logic High Drive	I_{OH}	8			mA
Output Logic Low Drive	I_{OL}	8			mA
Output Rise/Fall Time ² , $f_o \leq 10\text{MHz}$	$t_{R/F}$			3	ns
$f_o > 10\text{MHz}$				2	ns
Duty Cycle ³	SYM	45		55	%
Operating Temperature (ordering option)		-10/70 or -40/85			°C
Storage Temperature		-55		125	°C
Stability ⁴ (ordering option)		$\pm 25, \pm 50, \pm 100$			ppm
Output Enable/Disable ⁵					V
Output Enabled		$0.7 \cdot V_{DD}$			
Output Disabled				$0.3 \cdot V_{DD}$	
Start-up time				2	ms

1. A 0.01uF and a 0.1uF capacitor should be located as close to the supply as possible (to ground).
2. Figure 1 defines these parameters. Figure 2 illustrates the operating conditions under which these parameters are tested and specified.
3. Symmetry is measured defined as On Time/Period.
4. Includes calibration tolerance, operating temperature, supply voltage variations, aging and shock and vibration (not under operation).
5. Output will be enabled if enable/disable is left open.

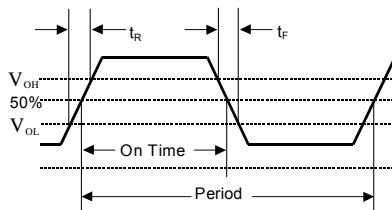

Figure 1. Output Waveform

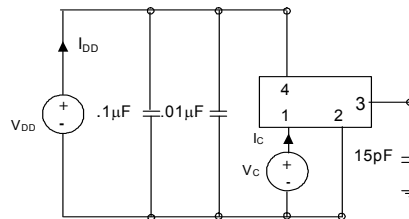

Figure 2. Typical Output Test Conditions (25±5°C)

VCS3 Data Sheet

Table 2. Electrical Performance, 2.5V option					
Parameter	Symbol	Min	Typical	Maximum	Units
Frequency	f_O	1.0		166.000	MHz
Operating Supply Voltage ¹	V_{DD}	2.25	2.5	2.75	V
Absolute Maximum Voltage		-0.5		5.0	V
Supply Current, Output Enabled < 30 MHz 30.01 to 75 MHz 75.01 to 166 MHz	I_{DD}			8.0 10.0 15.0	mA
Supply Current, Out disabled	I_{DD}			15	uA
Output Logic Levels Output Logic High ² Output Logic Low ² Output Logic High Drive Output Logic Low Drive	V_{OH} V_{OL} I_{OH} I_{OL}	$0.9 \cdot V_{DD}$ 8 8		$0.1 \cdot V_{DD}$	V V mA mA
Output Rise/Fall Time ² , $f_o \leq 10\text{MHz}$ $f_o > 10\text{MHz}$	t_R/t_F			4 3	ns ns
Duty Cycle ³	SYM	45		55	%
Operating Temperature (ordering option)		-10/70 or -40/85			°C
Storage Temperature		-55		125	°C
Stability ⁴ (ordering option)		$\pm 25, \pm 50, \pm 100$			ppm
Output Enable/Disable ⁵ Output Enabled Output Disabled		$0.7 \cdot V_{DD}$		$0.3 \cdot V_{DD}$	V
Start-up time				2	Ms

1. A 0.01uF and a 0.1uF capacitor should be located as close to the supply as possible (to ground).
2. Figure 3 defines these parameters. Figure 4 illustrates the operating conditions under which these parameters are tested and specified.
3. Symmetry is measured defined as On Time/Period.
4. Includes calibration tolerance, operating temperature, supply voltage variations, aging and shock and vibration (not under operation).
5. Output will be enabled if enable/disable is left open.

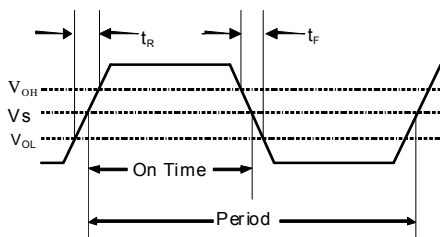

Figure 3. Output Waveform

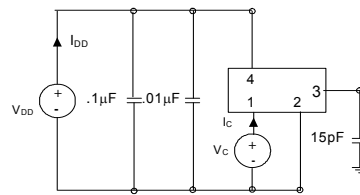

Figure 4. Typical Output Test Conditions (25±5°C)

VCS3 Data Sheet

Table 3. Electrical Performance, 1.8V option					
Parameter	Symbol	Min	Typical	Maximum	Units
Frequency	f_O	0.8		133.00	MHz
Operating Supply Voltage ¹	V_{DD}	1.62	1.8	1.98	V
Absolute Maximum Voltage		-0.5		3.6	V
Supply Current, Output Enabled < 30 MHz 30.01 to 75 MHz 75.01 to 133 MHz	I_{DD}			6 8 12	mA
Supply Current, Out disabled	I_{DD}			15	uA
Output Logic Levels Output Logic High ² Output Logic Low ² Output Logic High Drive Output Logic Low Drive	V_{OH} V_{OL} I_{OH} I_{OL}	$0.9 \cdot V_{DD}$ 8 8		$0.1 \cdot V_{DD}$	V V mA mA
Output Rise/Fall Time ² , $f_o \leq 10\text{MHz}$ $f_o > 10\text{MHz}$	t_R/t_F			5 4	ns ns
Duty Cycle ³	SYM	45		55	%
Operating temperature (ordering option)		-10/70 or -40/85			°C
Storage Temperature		-55		125	°C
Stability ⁴ (ordering option)		$\pm 25, \pm 50, \pm 100$			ppm
Output Enable/Disable ⁵ Output Enabled Output Disabled		$0.7 \cdot V_{DD}$		$0.3 \cdot V_{DD}$	V
Start-up time				2	ms

1. A 0.01uF and a 0.1uF capacitor should be located as close to the supply as possible (to ground) is recommended.
2. Figure 5 defines these parameters. Figure 6 illustrates the operating conditions under which parameters are tested/specified.
3. Symmetry is measured defined as On Time/Period.
4. Includes calibration tolerance, operating temperature, supply voltage variations, aging and shock and vibration (not under operation).
5. Output will be enabled if enable/disable is left open.

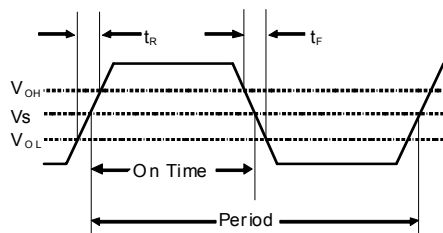

Figure 5. Output Waveform

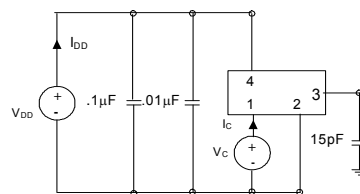

Figure 6. Typical Output Test Conditions (25±5°C)

Enable/Disable Functional Description

Under normal operation the Enable/Disable is left open or set to a logic high state. When the E/D is set to a logic low, the oscillator stops and the output is in a high impedance state. This helps reduce power consumption as well as facilitating board testing and troubleshooting.

Tri-state Functional Description

Under normal operation the tri-state is left open or set to a logic high state. When the tri-state is set to a logic low, the oscillator remains active but the output buffer is in a high impedance state. This helps facilitate board testing and troubleshooting.

Table 4. Outline Diagrams, Pad Layout and Pin Out

Pin #	Symbol	Function
1	E/D	Tri-state, Enable/Disable
2	GND	Electrical and Case Ground
3	f_o	Output Frequency
4	V_{DD}	Supply Voltage

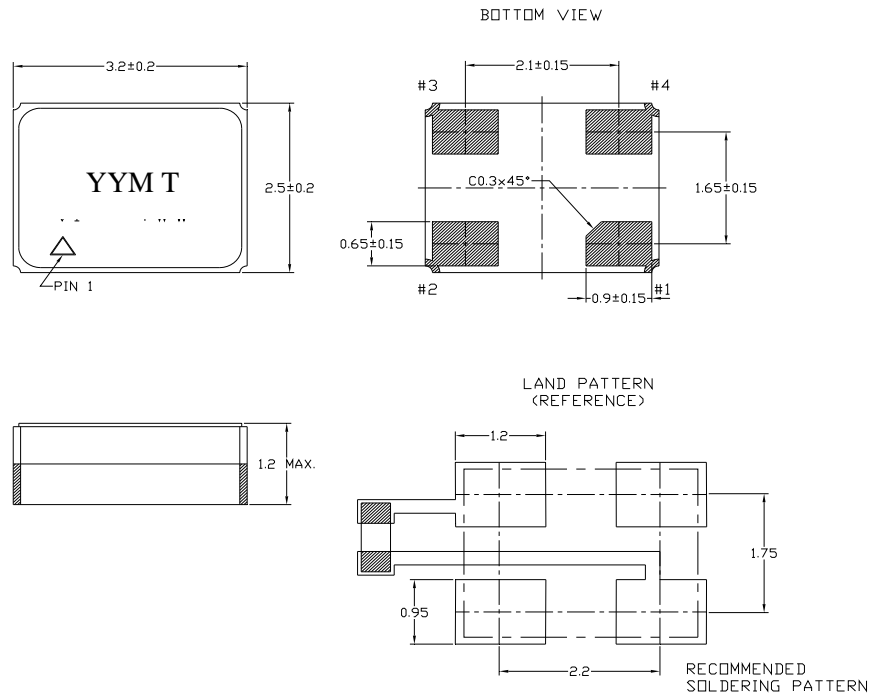

Contact Pads are gold over nickel

Figure 7, Package drawing

VCS3 Data Sheet

Reliability

The VCS3 qualification tests have included:

Table 5. Environmental Compliance

Parameter	Conditions
Mechanical Shock	MIL-STD-883 Method 2022
Mechanical Vibration	MIL-STD-883 Method 2007
Temperature Cycle	MIL-STD-883 Method 1010
Solderability	MIL-STD-883 Method 2003
Gross and Fine Leak	MIL-STD-883 Method 1014
Resistance to Solvents	MIL-STD-883 Method 2015
MSL	1

Handling Precautions

Although ESD protection circuitry has been designed into the the VCS3, proper precautions should be taken when handling and mounting. VI employs a Human Body Model and a Charged-Device Model (CDM) for ESD susceptibility testing and design protection evaluation. ESD thresholds are dependent on the circuit parameters used to define the model. Although no industry wide standard has been adopted for the CDM, a standard HBM of resistance = 1.5kohms and capacitance = 100pF is widely used and therefore can be used for comparison purposes.

Table 6. ESD Ratings

Model	Minimum	Conditions
Human Body Model	1000	MIL-STD-883 Method 3115
Charged Device Model	1500	JESD 22-C101

Suggested IR profile

Devices are built using lead free epoxy and can also be subjected to standard lead free IR reflow conditions, Table 7 shows max temperatures and lower temperatures can also be used e.g. peak temperature of 220C.

Table 7. Reflow Profile (IPC/JEDEC J-STD-020)

Parameter	Symbol	Value
Preheat Time	t_s	150 sec Min, 200 sec Max
Ramp Up	R_{UP}	3 °C/sec Max
Time Above 217 °C	t_L	60 sec Min, 150 sec Max
Time To Peak Temperature	t_{AMB-P}	480 sec Max
Time At 260 °C (max)	t_p	20 sec Min, 40 sec Max
Time At 240 °C (max)	t_{p2}	60 sec Max
Ramp Down	R_{DN}	6 °C/sec Max

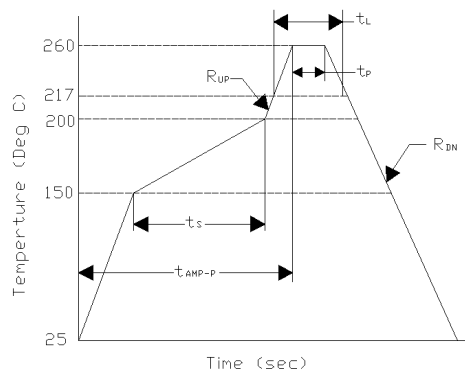

Ordering Information

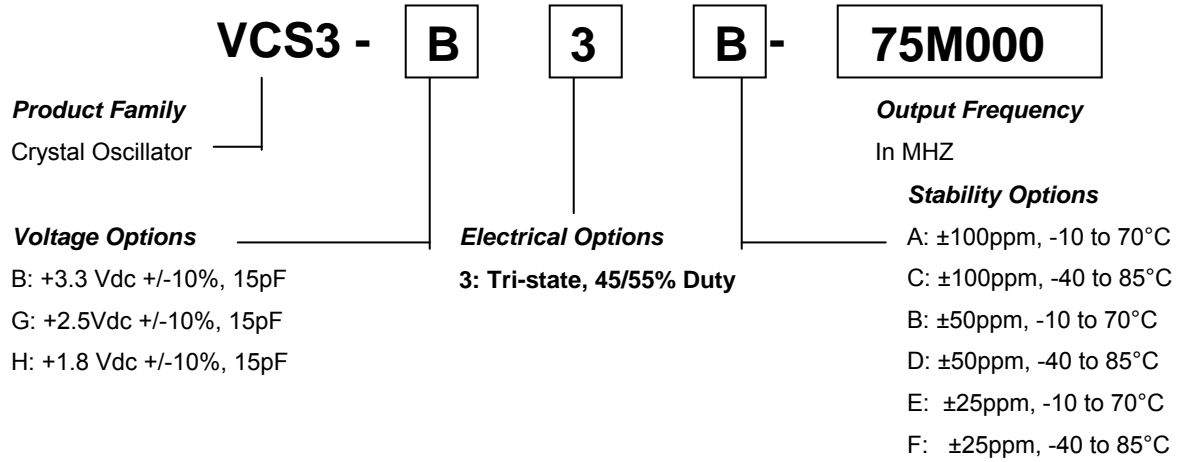

Note: Not all combinations are available.

For Additional Information, Please Contact:



USA: Vectron International • 267 Lowell Road, Hudson, NH 03051
• Tel: 1-88-VECTRON-1 • Fax: 1-888-FAX-VECTRON

www.vectron.com

Feb08, 2011