

## TUNING FORK CRYSTAL UNIT (SMD · Ceramic Package)

RoHS compliant / Pb free

# CM315D

3,000pcs/reel

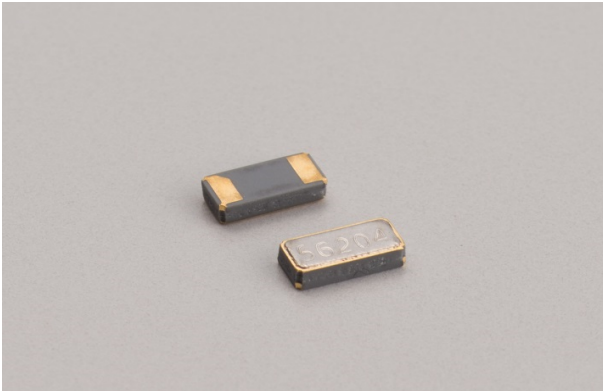

### ■ FEATURES

- Frequency range : 32.768kHz
- External dimensions (mm)  
L : 3.3 x W : 1.6 x H : 0.9
- Applications  
Smart Meters / Small mobile devices / Consumer products

### ■ DIMENSION [mm]

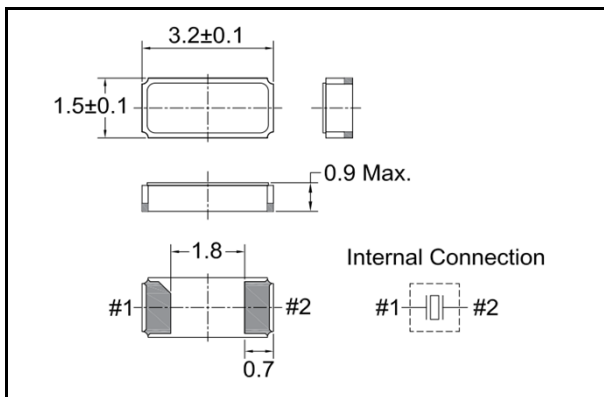

### ■ SOLDER PAD LAYOUT [mm]

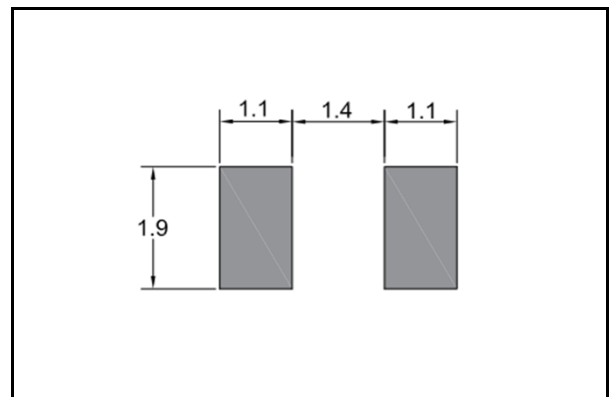

### ■ STANDARD SPECIFICATIONS

| Item                         | Model          | CM315D  | Conditions                      |
|------------------------------|----------------|---|---------------------------------|
| Nominal Frequency            | $f_0$          | 32.768kHz   |                                 |
| Frequency Tolerance          | $\Delta f/f_0$ | $\pm 5\text{ppm} / \pm 10\text{ppm} / \pm 20\text{ppm}$ | at 25°C                         |
| Load capacitance             | $C_L$          | 6.0pF / 7.0pF / 9.0pF / 12.5pF                          | Please specify your requirement |
| Operating Temperature Range  | $T_{OPR}$      | -40°C ~ +85°C   |                                 |
| Storage Temperature Range    | $T_{STR}$      | -55°C ~ +125°C  |                                 |
| Turnover Temperature         | $T_M$          | 25°C $\pm$ 5°C  |                                 |
| Temperature Coefficient      | $\beta$        | -0.034 $\pm$ 0.006ppm/°C <sup>2</sup>                   |                                 |
| Motional (series) resistance | $R_1$          | 70K $\Omega$ Max.                                       | at 25°C                         |
| Level of drive               | DL             | 1 $\mu$ W Max.  |                                 |
| Aging (first year)           | $\Delta f/f_0$ | $\pm 3\text{ppm}$ Max.                                  | 25°C $\pm$ 3°C                  |
| Shunt capacitance            | $C_0$          | 0.95pF Typ.   |                                 |

## ■ PART NUMBERING SYSTEM

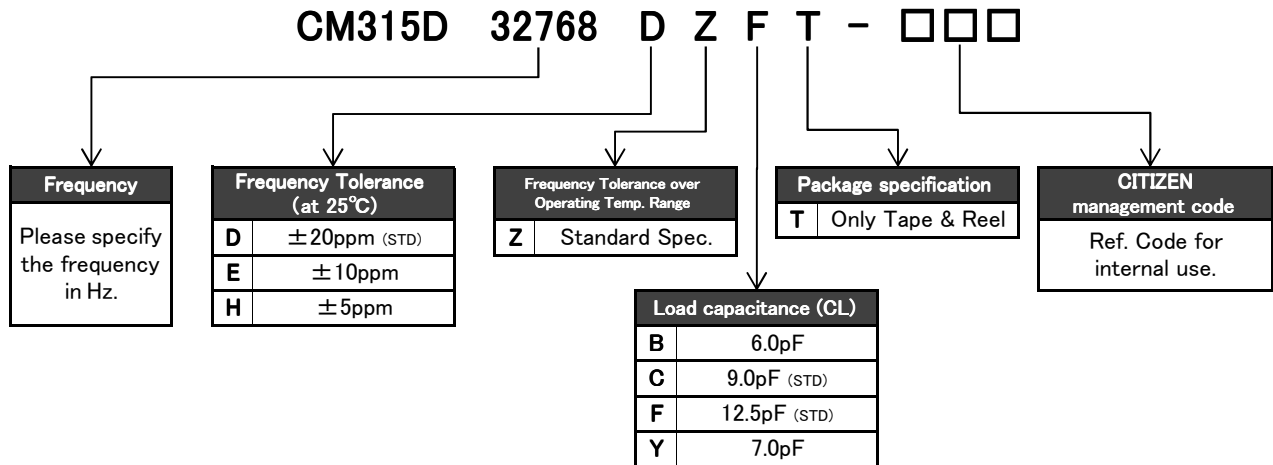

\*Please contact us for specifications available.

## ■ Part Marking [standard]



y : The last digit of production year

m : Production month (See Table.1)

# : Production Lot No.

Table.1

| Month | Jan | Feb | ... | Sep | Oct | Nov | Dec |
|-------|-----|-----|-----|-----|-----|-----|-----|
| Code  | 1   | 2   | ... | 9   | X   | Y   | Z   |

## ■ Reflow profile

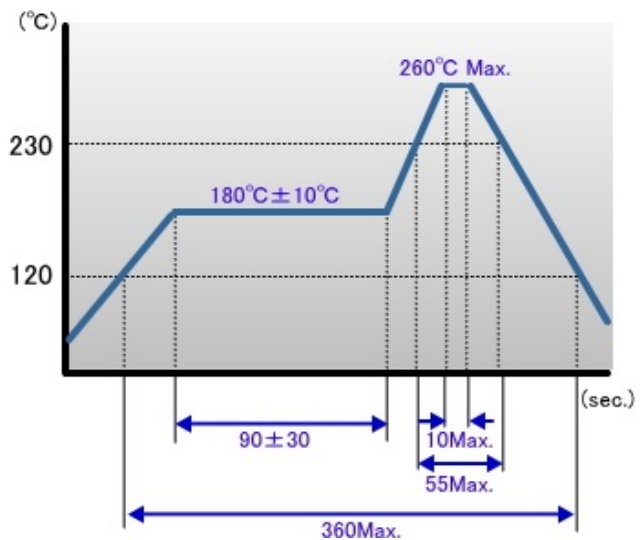

## ■ Packing

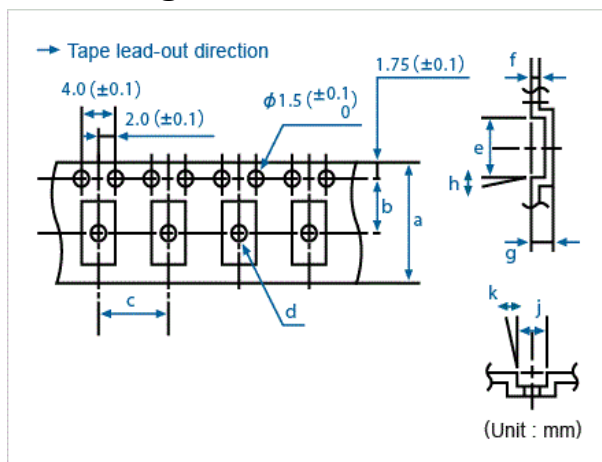

Conforming to JIS C 0806 TB1208NEIAJ and RC-1009B TE1208N

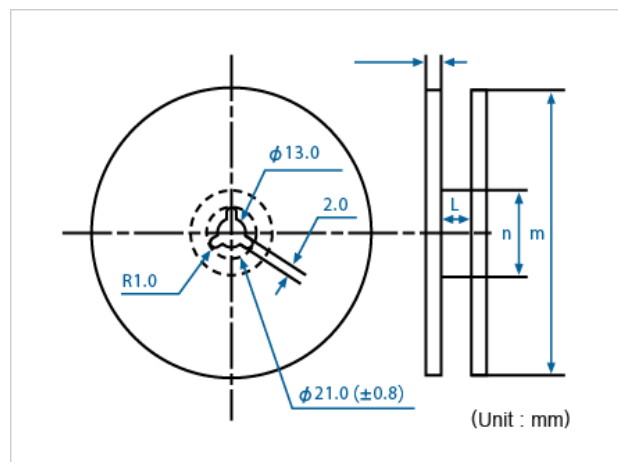

Conforming to JIS C 0806 R12R and EIAJ RC-1009B R15

| Q'ty/reel | a    | b   | c   | d (φ) | e   | f   | g   | h  | j   | k  | l    | m (φ) | n (φ) |
|-----------|------|-----|-----|-------|-----|-----|-----|----|-----|----|------|-------|-------|
| 3,000     | 12.0 | 5.5 | 4.0 | 1.0   | 3.6 | 0.3 | 1.0 | 5° | 1.9 | 5° | 13.0 | 180   | 60    |

Rev.1