



WT24-2B420

W24-2

PHOTOELECTRIC SENSORS

SICK
Sensor Intelligence.



Illustration may differ



Ordering information

Type	Part no.
WT24-2B420	1017885

Other models and accessories → www.sick.com/W24-2

Detailed technical data

Features

Sensor/ detection principle	Photoelectric proximity sensor, Background suppression
Dimensions (W x H x D)	27 mm x 87.5 mm x 65 mm
Housing design (light emission)	Rectangular
Sensing range max.	100 mm ... 2,500 mm ¹⁾
Sensing range	100 mm ... 2,500 mm ¹⁾
Type of light	Infrared light
Light source	LED ²⁾
Light spot size (distance)	Ø 80 mm (2,500 mm)
Adjustment	PotentiometerPotentiometer
Time type	On delay Off delay
Delay time	Adjustable via time delay selector switch, 0.5 s, 10 s

¹⁾ Object with 90 % reflectance (referred to standard white, DIN 5033).

²⁾ Average service life: 100,000 h at T_J = +25 °C.

Communication interface

Communication interface	-
--------------------------------	---

Mechanics/electronics

Supply voltage	10 V DC ... 30 V DC ¹⁾
Ripple	< 5 V _{pp} ²⁾
Power consumption	≤ 150 mA ³⁾
Output type	NPN PNP
Switching mode	Light/dark switching
Switching mode selector	Selectable via PNP/NPN selector, selectable via light/dark selector
Output current I_{max.}	≤ 100 mA
Response time	≤ 500 μs ⁴⁾
Switching frequency	1,000 Hz ⁵⁾
Connection type	Male connector M12, 4-pin
Circuit protection	A ⁶⁾ C ⁷⁾ D ⁸⁾
Protection class	II ⁹⁾
Weight	330 g
Front screen heating	✓ ¹⁰⁾
Housing material	Metal, Zinc diecast
Optics material	Plastic, PMMA
Enclosure rating	IP69K
Test input sender off	TE to 0 V
Ambient operating temperature	-40 °C ... +60 °C
Ambient storage temperature	-40 °C ... +75 °C

¹⁾ Limit values when operated in short-circuit protected network: max. 8 A.

²⁾ May not exceed or fall below U_v tolerances.

³⁾ Without load.

⁴⁾ Signal transit time with resistive load.

⁵⁾ With light/dark ratio 1:1.

⁶⁾ A = V_S connections reverse-polarity protected.

⁷⁾ C = interference suppression.

⁸⁾ D = outputs overcurrent and short-circuit protected.

⁹⁾ Reference voltage: 50 V DC.

¹⁰⁾ Static, low heat output, use in +5 °C ... +15 °C.

Classifications

ECl@ss 5.0	27270904
ECl@ss 5.1.4	27270904
ECl@ss 6.0	27270904
ECl@ss 6.2	27270904
ECl@ss 7.0	27270904
ECl@ss 8.0	27270904
ECl@ss 8.1	27270904
ECl@ss 9.0	27270904

ETIM 5.0	EC002719
ETIM 6.0	EC002719
UNSPSC 16.0901	39121528

Adjustments possible

WT24-2, WL24-2, WS/WE24-2, DC

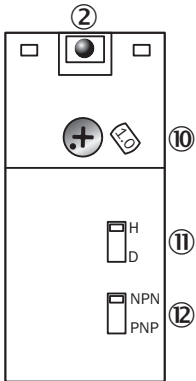

- ② LED signal strength indicator
- ⑩ Adjustment sensing range (WT) / sensitivity (WL, WS/WE)
- ⑪ Light/dark selector
- ⑫ NPN/PNP changeover switch

Connection diagram

Cd-117

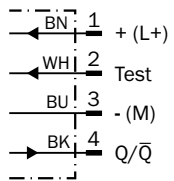

Characteristic curve

WT24-2, infrared light

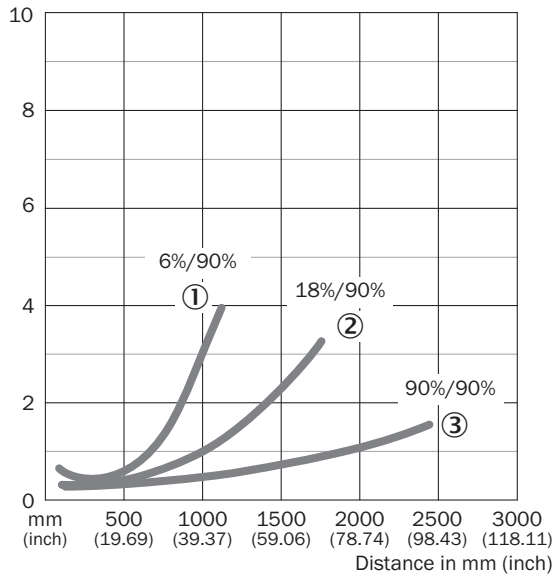

- ① Sensing range on black, 6% remission
- ② Sensing range on gray, 18 % remission
- ③ Sensing range on white, 90% remission

Sensing range diagram

WT24-2, infrared light

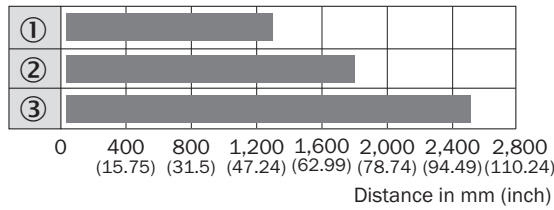

- Sensing range
- ① Sensing range on black, 6% remission
- ② Sensing range on gray, 18 % remission
- ③ Sensing range on white, 90% remission

Dimensional drawing (Dimensions in mm (inch))



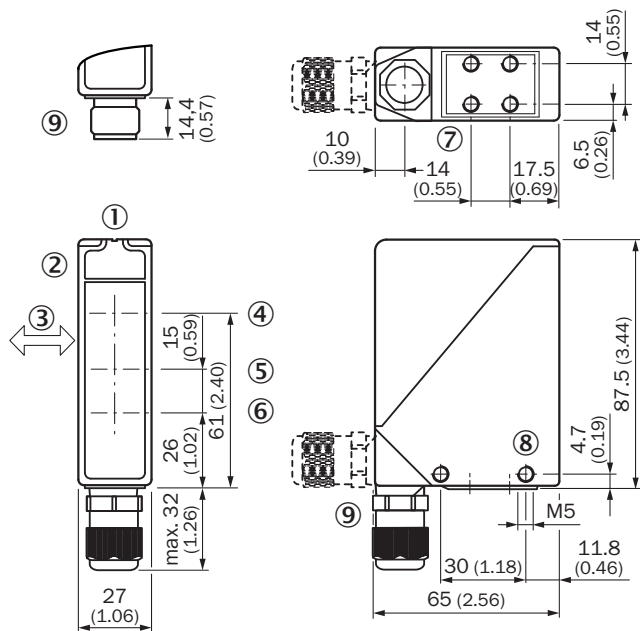

WT24-2













- ① Alignment sight
- ② LED signal strength indicator
- ③ Standard direction of the material being detected
- ④ Center of optical axis, sender
- ⑤ Center of optical axis, receiver (close range)
- ⑥ Center of optical axis, receiver (far range)
- ⑦ M5 threaded mounting hole, 6 mm deep
- ⑧ M5 threaded mounting hole, through-hole
- ⑨ M16 screw fixing and plug rotatable by 90°

Recommended accessories

Other models and accessories → www.sick.com/W24-2

	Brief description	Type	Part no.
Universal bar clamp systems			
	Universal bar clamp for mounting bars with 12 mm diameter, Zinc diecast, without mounting plate and screws	BEF-KHS-KH3	5322626
	Plate N04 for universal clamp, steel, Zinc plated steel (sheet), Zinc die cast (clamping bracket), Universal clamp (5322626), mounting hardware	BEF-KHS-N04	2051610
Device protection (mechanical)			
	Water cooling plate	BEF-KP-W24	2015071
	Dust protection tube, air-purged, Aluminum (anodised), mounting hardware included	OBS-W24	2015069

	Brief description	Type	Part no.
	Weather hood for universal clamp bracket, steel, zinc coated, mounting hardware included	OBW-KHS-M01	2023240
	Weather hood, Aluminum (anodised), mounting hardware included	OBW-W24	2015070
		WSG1-01	1018470
Mounting brackets and plates			
	Mounting bracket, small, Stainless steel, without mounting hardware	BEF-WK-W24	4027532
	Mounting bracket, Stainless steel (1.4301), mounting hardware included	BEF-WN-W24	2015248
Plug connectors and cables			
	Head A: female connector, M12, 4-pin, straight Head B: cable Cable: PVC, unshielded, 2 m	DOL-1204-G02M	6009382
	Head A: female connector, M12, 4-pin, straight Head B: cable Cable: drag chain use, PUR, halogen-free, unshielded, 2 m	DOL-1204-G02MC	6025900
	Head A: female connector, M12, 4-pin, straight Head B: cable Cable: PVC, unshielded, 5 m	DOL-1204-G05M	6009866
	Head A: female connector, M12, 4-pin, straight Head B: cable Cable: drag chain use, PUR, halogen-free, unshielded, 5 m	DOL-1204-G05MC	6025901
	Head A: female connector, M12, 4-pin, angled Head B: cable Cable: PVC, unshielded, 2 m	DOL-1204-W02M	6009383
	Head A: female connector, M12, 4-pin, angled Head B: cable Cable: drag chain use, PUR, halogen-free, unshielded, 2 m	DOL-1204-W02MC	6025903
	Head A: female connector, M12, 4-pin, angled Head B: cable Cable: PVC, unshielded, 5 m	DOL-1204-W05M	6009867
	Head A: female connector, M12, 4-pin, angled Head B: cable Cable: drag chain use, PUR, halogen-free, unshielded, 5 m	DOL-1204-W05MC	6025904
	Head A: female connector, M12, 4-pin, straight Head B: - Cable: unshielded	DOS-1204-G	6007302
	Head A: female connector, M12, 4-pin, angled Head B: - Cable: unshielded	DOS-1204-W	6007303

	Brief description	Type	Part no.
Alignment aids			
	Adapter for alignment aid AR60	Adapter AR60 for W24-2	4032976

SICK AT A GLANCE

SICK is one of the leading manufacturers of intelligent sensors and sensor solutions for industrial applications. A unique range of products and services creates the perfect basis for controlling processes securely and efficiently, protecting individuals from accidents and preventing damage to the environment.

We have extensive experience in a wide range of industries and understand their processes and requirements. With intelligent sensors, we can deliver exactly what our customers need. In application centers in Europe, Asia and North America, system solutions are tested and optimized in accordance with customer specifications. All this makes us a reliable supplier and development partner.

Comprehensive services complete our offering: SICK LifeTime Services provide support throughout the machine life cycle and ensure safety and productivity.

For us, that is “Sensor Intelligence.”

WORLDWIDE PRESENCE:

Contacts and other locations –www.sick.com