



# PJQ2888

## 20V P-Channel Enhancement Mode MOSFET with TVS Diode

**Voltage** -20 V **Current** -1.5A

### Features

- RDS(ON) , VGS@-4.5V, ID@-1.5A<325mΩ
- RDS(ON) , VGS@-2.5V, ID@-1.2A<420mΩ
- RDS(ON) , VGS@-2.5V, ID@-0.5A<600mΩ
- Advanced Trench Process Technology
- Specially Designed for Switch Load, PWM Application, etc.
- ESD Protected 2KV HBM
- Lead free in compliance with EU RoHS 2011/65/EU directive.
- Green molding compound as per IEC61249 Std.  
(Halogen Free)

### Mechanical Data

- Case : DFN2020-8L Package
- Terminals : Solderable per MIL-STD-750, Method 2026
- Approx. Weight : 0.00032 ounces, 0.0093 grams
- Marking : 888

DFN2020-8L

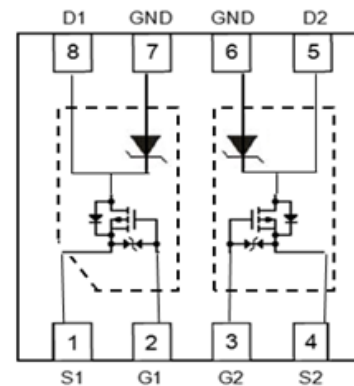
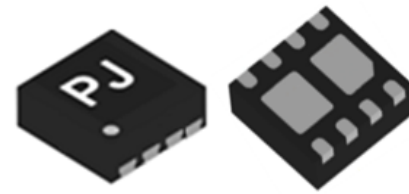

## Maximum Ratings and Thermal Characteristics (T<sub>A</sub>=25°C unless otherwise noted)

PARAMETER	SYMBOL	LIMIT	UNITS
Drain-Source Voltage	V <sub>DS</sub>	-20	V
Gate-Source Voltage	V <sub>GS</sub>	±8	V
Continuous Drain Current	I <sub>D</sub>	-1.5	A
Pulsed Drain Current <sup>(Note 4)</sup>	I <sub>DM</sub>	-6.0	A
Power Dissipation	P <sub>D</sub>	T <sub>a</sub> =25°C	1.25
		Derate above 25°C	10
Operating Junction and Storage Temperature Range	T <sub>J</sub> , T <sub>STG</sub>	-55~150	°C
Typical Thermal resistance	R <sub>θJA</sub>	100	°C/W
- Junction to Ambient <sup>(Note 3)</sup>			



# PJQ2888

## Electrical Characteristics ( $T_A=25^{\circ}\text{C}$ unless otherwise noted)

PARAMETER	SYMBOL	TEST CONDITION	MIN.	TYP.	MAX.	UNITS
<b>Static</b>						
Drain-Source Breakdown Voltage	$BV_{DSS}$	$V_{GS}=0V, I_D=-250\mu A$	-20	-	-	V
Gate Threshold Voltage	$V_{GS(th)}$	$V_{DS}=V_{GS}, I_D=-250\mu A$	-0.4	-0.64	-1.0	V
Drain-Source On-State Resistance	$R_{DS(on)}$	$V_{GS}=-4.5V, I_D=-1.5A$	-	240	325	m $\Omega$
		$V_{GS}=-2.5V, I_D=-1.2A$	-	295	420	
		$V_{GS}=-1.8V, I_D=-0.5A$	-	405	600	
Zero Gate Voltage Drain Current	$I_{DSS}$	$V_{DS}=-20V, V_{GS}=0V$	-	-0.02	-1	$\mu A$
Gate-Source Leakage Current	$I_{GSS}$	$V_{GS}=\pm 8V, V_{DS}=0V$	-	$\pm 3.5$	$\pm 10$	$\mu A$
<b>Dynamic</b>						
Total Gate Charge	$Q_g$	$V_{DS}=-10V, I_D=-1.5A,$ $V_{GS}=-4.5V$ (Note 1,2)	-	2.2	-	nC
Gate-Source Charge	$Q_{gs}$		-	0.4	-	
Gate-Drain Charge	$Q_{gd}$		-	0.5	-	
Input Capacitance	$C_{iss}$	$V_{DS}=-10V, V_{GS}=0V,$ $f=1.0\text{MHz}$	-	150	-	pF
Output Capacitance	$C_{oss}$		-	27	-	
Reverse Transfer Capacitance	$C_{rss}$		-	9	-	
<b>Switching</b>						
Turn-On Delay Time	$t_{d(on)}$	$V_{DD}=-10V, I_D=-1.5A,$ $V_{GS}=-4.5V,$ $R_G=6\Omega$ (Note 1,2)	-	11	-	ns
Turn-On Rise Time	$t_r$		-	38	-	
Turn-Off Delay Time	$t_{d(off)}$		-	130	-	
Turn-Off Fall Time	$t_f$		-	75	-	
<b>Drain-Source Diode</b>						
Maximum Continuous Drain-Source Diode Forward Current	$I_S$	---	-	-	-1.0	A
Diode Forward Voltage	$V_{SD}$	$I_S=-1A, V_{GS}=0V$	-	-0.93	-1.2	V

NOTES :

1. Pulse width  $\leq 300\mu s$ , Duty cycle  $\leq 2\%$
2. Essentially independent of operating temperature typical characteristics.
3.  $R_{\theta JA}$  is the sum of the junction-to-case and case-to-ambient thermal resistance where the case thermal reference is defined as the solder mounting surface of the drain pins mounted on a 1 inch FR-4 with 2oz. square pad of copper.
4. The maximum current rating is package limited.



# PJQ2888

## Electrical Characteristics ( $T_A=25^{\circ}\text{C}$ unless otherwise noted)

PARAMETER	SYMBOL	TEST CONDITION	MIN.	TYP.	MAX.	UNITS
<b>TVS Diode</b>						
Working Peak Reverse Voltage	$V_{RWM}$	---	-	-	15	V
Maximum Reverse Leakage Current	$I_R$	$V_{RWM}=15\text{V}$	-	-	1	$\mu\text{A}$
Breakdown Voltage	$V_{BR}$	$I_T=1\text{mA}$	17	-	-	V
Max. Capacitance	$C_J$	$f=1\text{MHz}, V_R=0\text{V}$	-	-	15	$\text{pF}$
Clamping Voltage	$V_C$	Max Per 8x20us	-	-	30	V
Maximum Reverse Peak Pulse Current	$I_{PP}$	---	-	-	2	A
Test Current	$I_T$	---	-	-	1.0	$\text{mA}$



# PJQ2888

## TYPICAL CHARACTERISTIC CURVES

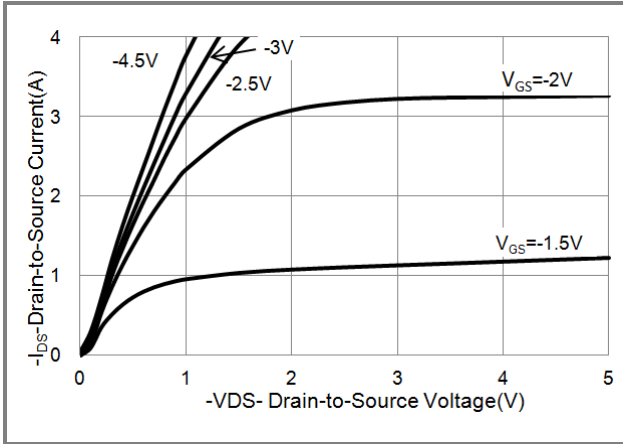

Fig.1 On-Region Characteristics

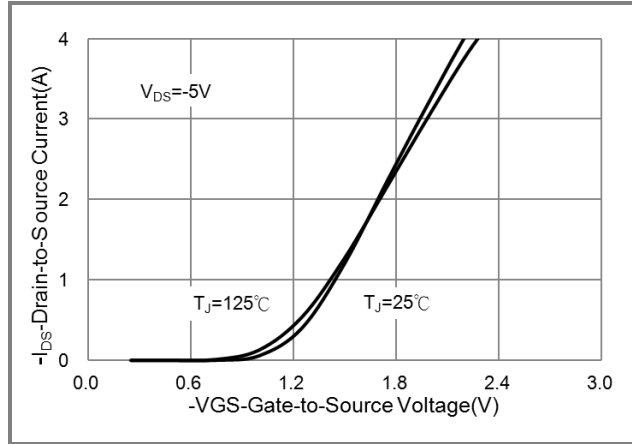

Fig.2 Transfer Characteristics

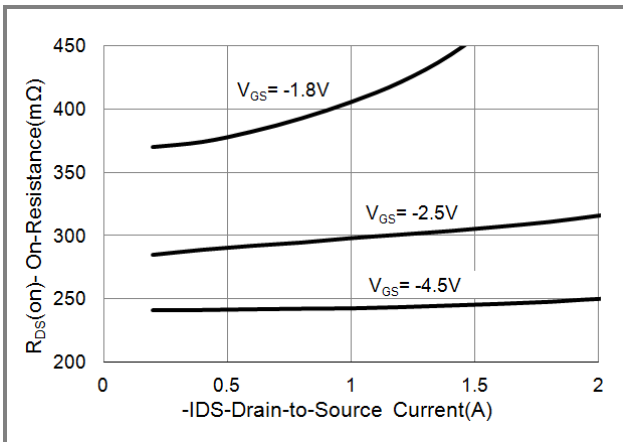

Fig.3 On-Resistance vs. Drain Current

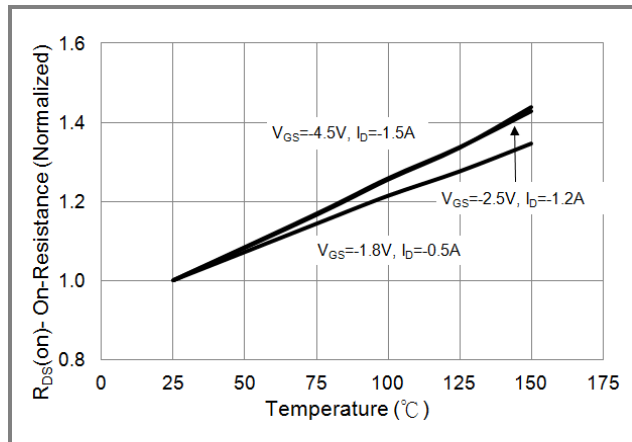

Fig.4 On-Resistance vs. Junction temperature

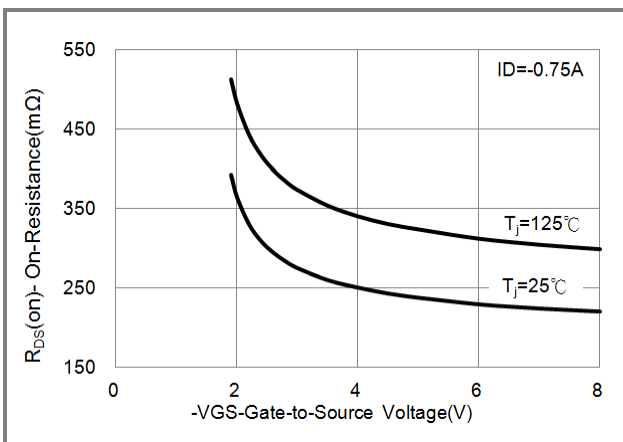

Fig.5 On-Resistance Variation with VGS.

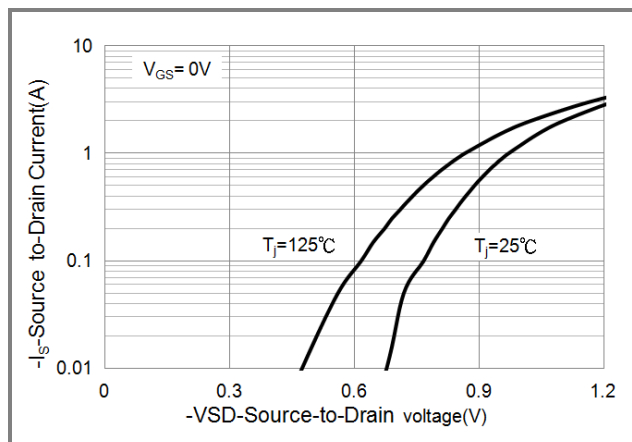

Fig.6 Body Diode Characteristics



# PJQ2888

## TYPICAL CHARACTERISTIC CURVES

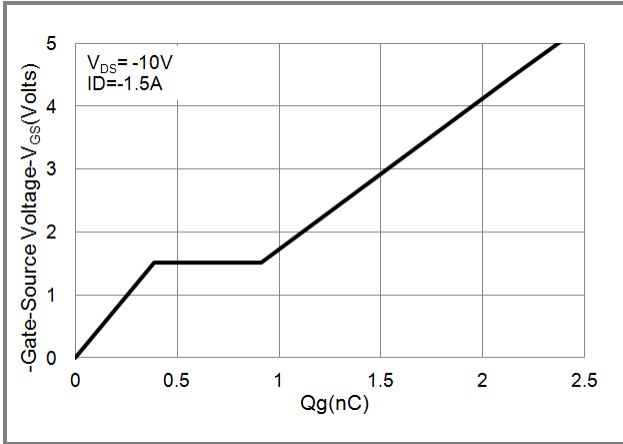

Fig.7 Gate-Charge Characteristics

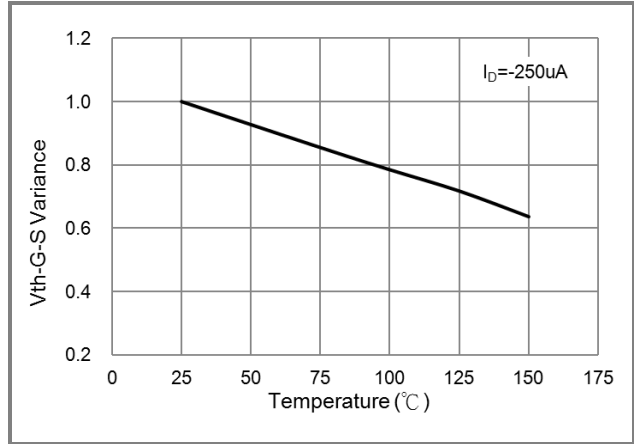

Fig.8 Threshold Voltage Variation with Temperature.

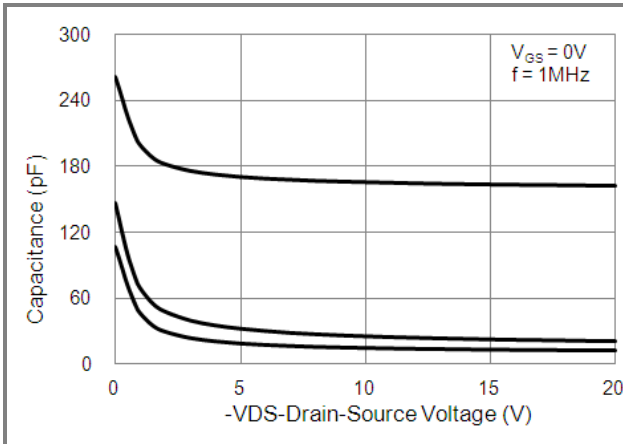

Fig.9 Capacitance vs. Drain-Source Voltage.

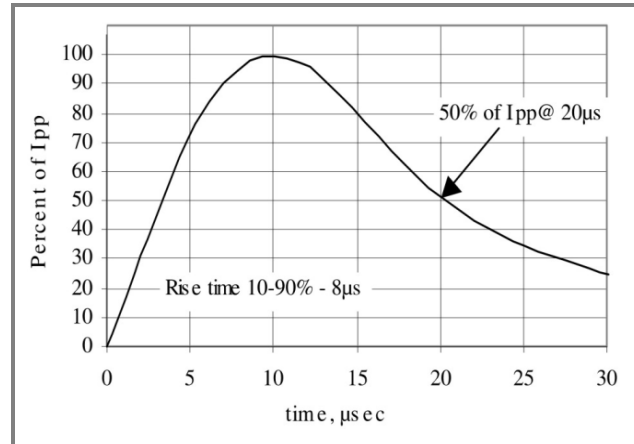

Fig.10 TVS Diode Surge Pulse Waveform Definition.

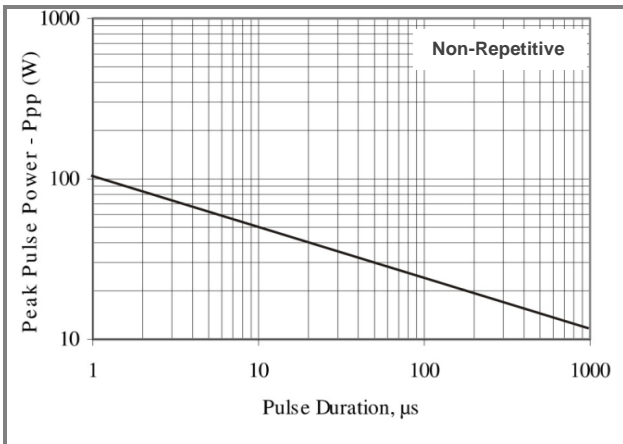

Fig.11 TVS Diode Peak Pulse Power vs. Pulse Time



# PJQ2888

## PART NO PACKING CODE VERSION

PART NO PACKING CODE	Package Type	Packing type	Marking	Version
PJQ2888_R1_00001	DFN2020-8L	3K pcs / 7" reel	888	Halogen free

## MOUNTING PAD LAYOUT

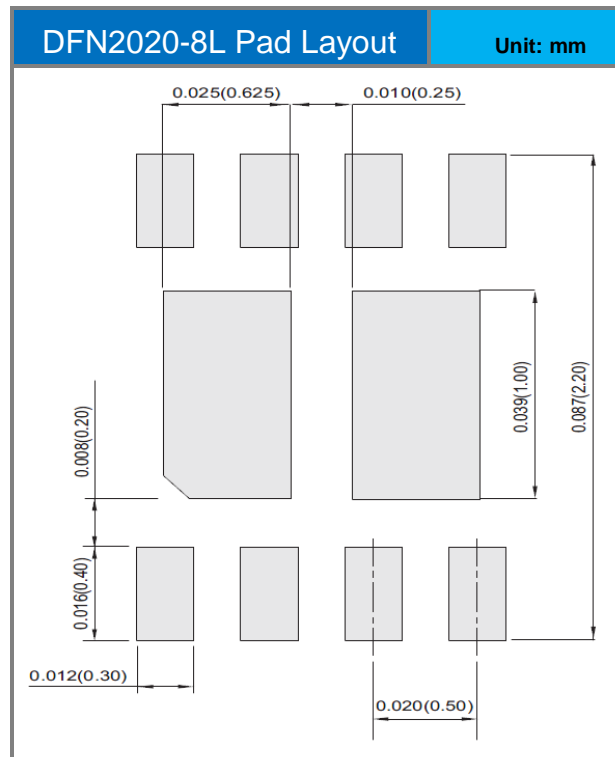
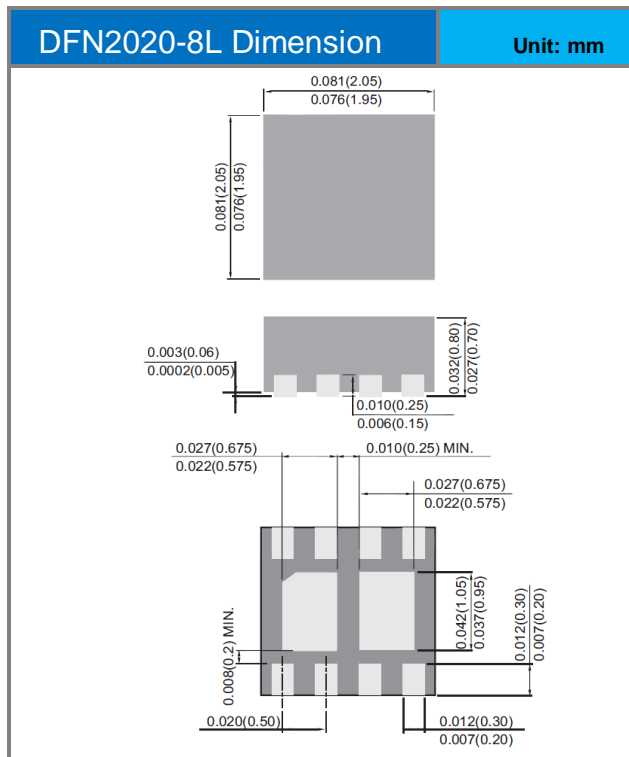



## PJQ2888

### Disclaimer

- Reproducing and modifying information of the document is prohibited without permission from Panjit International Inc..
- Panjit International Inc. reserves the rights to make changes of the content herein the document anytime without notification. Please refer to our website for the latest document.
- Panjit International Inc. disclaims any and all liability arising out of the application or use of any product including damages incidentally and consequentially occurred.
- Panjit International Inc. does not assume any and all implied warranties, including warranties of fitness for particular purpose, non-infringement and merchantability.
- Applications shown on the herein document are examples of standard use and operation. Customers are responsible in comprehending the suitable use in particular applications. Panjit International Inc. makes no representation or warranty that such applications will be suitable for the specified use without further testing or modification.
- The products shown herein are not designed and authorized for equipments requiring high level of reliability or relating to human life and for any applications concerning life-saving or life-sustaining, such as medical instruments, transportation equipment, aerospace machinery et cetera. Customers using or selling these products for use in such applications do so at their own risk and agree to fully indemnify Panjit International Inc. for any damages resulting from such improper use or sale.
- Since Panjit uses lot number as the tracking base, please provide the lot number for tracking when complaining.