

SPECIFICATION

PATENTED

Part No. : **TG.30.8112**

Product Name : Apex Black Right Angle TG.30
Ultra-Wideband 4G LTE Antenna

Feature : LTE / GSM / CDMA /DCS /PCS / WCDMA / UMTS /
HSDPA / GPRS / EDGE /GPS /Wi-Fi
698MHz to 960MHz, 1575.42MHz,
1710MHz to 2700Mhz
Patented
Typical 70%+ Efficiency and 3dBi+ Peak Gain
Dipole Swivel Terminal Antenna
90° termination with SMA(M) Connector
RoHS Compliant



1. Introduction

The Apex Black Right Angle TG.30 Dipole LTE Antenna – is primarily designed for use with 4G LTE modules and devices that require the highest possible efficiency and peak gain to deliver best in class throughput on all major cellular (2g/3g/4g) bands worldwide for access points, terminals and routers. The antenna is a ground plane independent antenna with a SMA (M) connector and swivel mechanism that allows the antenna part to be rotated. The Apex exhibits high efficiency across the ultra wide band and is backward compatible with 2G and 3G cellular applications such as GSM, LTE, UMTS, Wi-Fi and even has GPS included for Assisted GPS and/or E911 applications. With very high efficiency on every cellular band globally it is an ideal solution for any device requiring high, reliable performance. It is also guaranteed to meet any type approval or carrier certification requirements from a RF standpoint. It is an omnidirectional antenna and the radiation patterns display this and are stable across all bands.

It has a quality robust IP67 UV resistant housing (SMA connector is IP65) for use with wireless terminals. The swivel mechanism allows the antenna part itself to be orientated in different directions and can help avoid touching off other antennas or objects close by as well as helping with isolation by orientating the antenna in different directions in MIMO systems for when other TG.30 antennas are present on the same device.

This patented antenna is also available in White and straight and right angle configurations.

2. Specification

ELECTRICAL							
Frequency (MHz)	700~800	824~960	1575.42	1710 ~ 1880	1850 ~ 1990	1710 ~ 2170	2400~2700
Peak Gain (dBi)							
Free Space	2.7	2.1	0.3	3.5	3.6	3.6	5.3
30x30cm GP center	4.3	5.3	5.3	6.7	6.8	7.5	8.1
30x30cm GP edge	4.4	2.4	0.5	1.9	2.0	2.5	3.2
PCB edge	3.2	1.9	2.4	3.2	3.3	3.6	4.7
Average Gain							
Free Space	-0.7	-1.2	-1.2	-0.4	-0.4	-0.2	-0.6
30x30cm GP center	-2.8	-1.0	-2.4	-1.6	-1.8	-1.3	-1.2
30x30cm GP edge	-0.1	-4.3	-2.5	-2.0	-2.0	-2.0	-2.2
PCB edge	0.8	-1.9	-0.9	-0.6	-0.6	-0.6	-0.8
Efficiency							
Free Space	85%	75%	76%	90%	90%	90%	87%
30x30cm GP center	52%	39%	57%	70%	65%	74%	75%
30x30cm GP edge	91%	64%	56%	62%	62%	63%	60%
PCB edge	86%	87%	81%	86%	86%	86%	84%
Impedance	50Ω						
Polarization	Linear						
Radiation Pattern	Omni						
Input Power	10 W						
MECHANICAL							
Casing	UV Resistant PC/ABS						
Connector	SMA Male						
ENVIRONMENTAL							
Temperature Range	-40°C to 85°C						
Humidity	Non-condensing 65°C 95% RH						

3. Antenna Characteristics

3.1 Return Loss

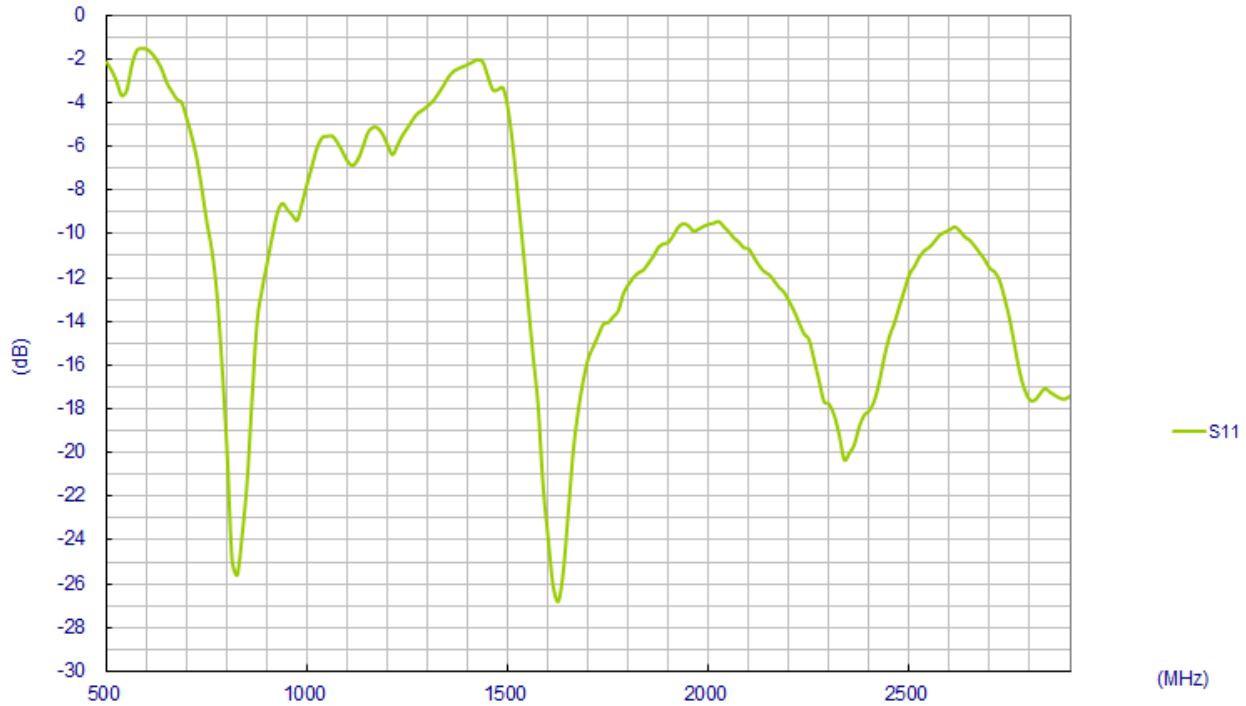

3.2 Peak Gain

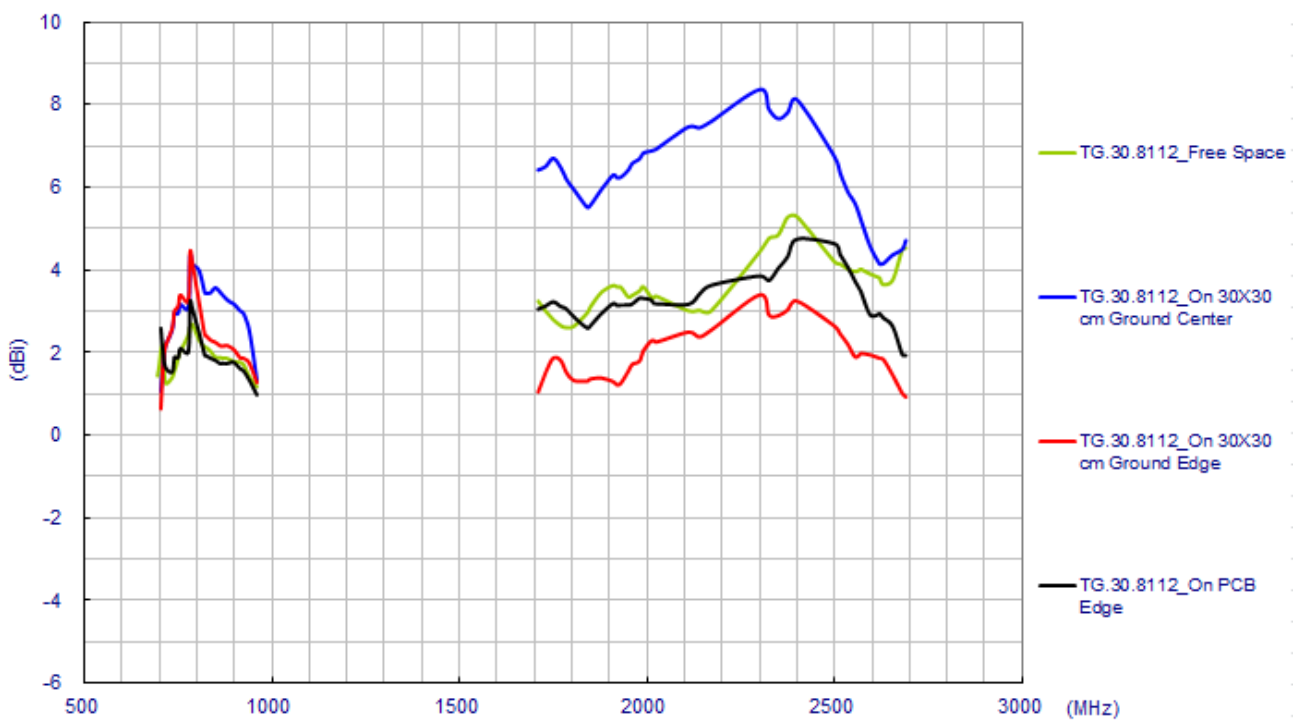

3.3 Average Gain

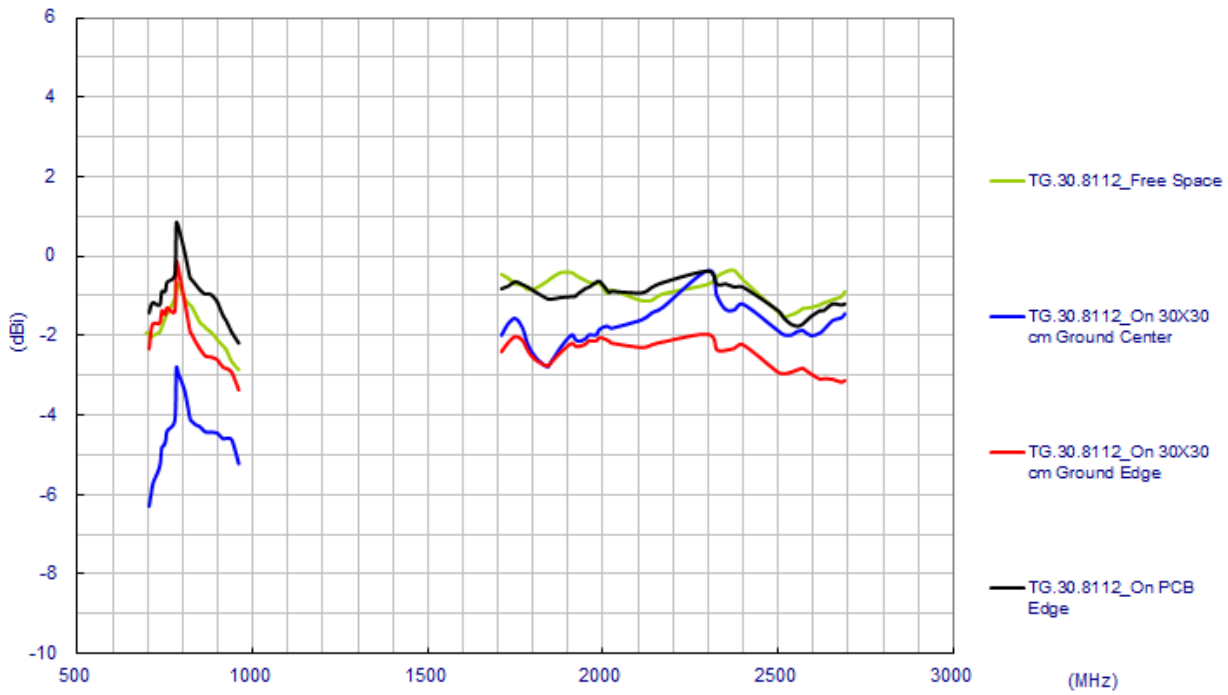

3.4 Efficiency

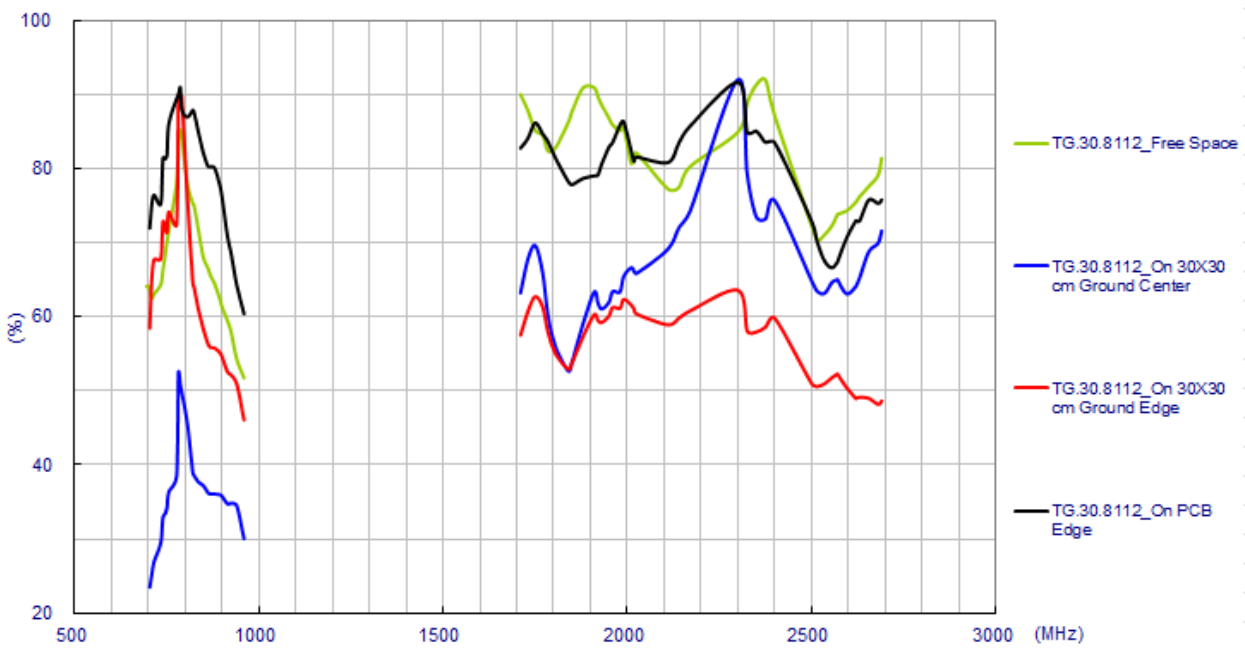

4. Antenna Radiation Patterns

4.1 Antenna setup (Free Space)

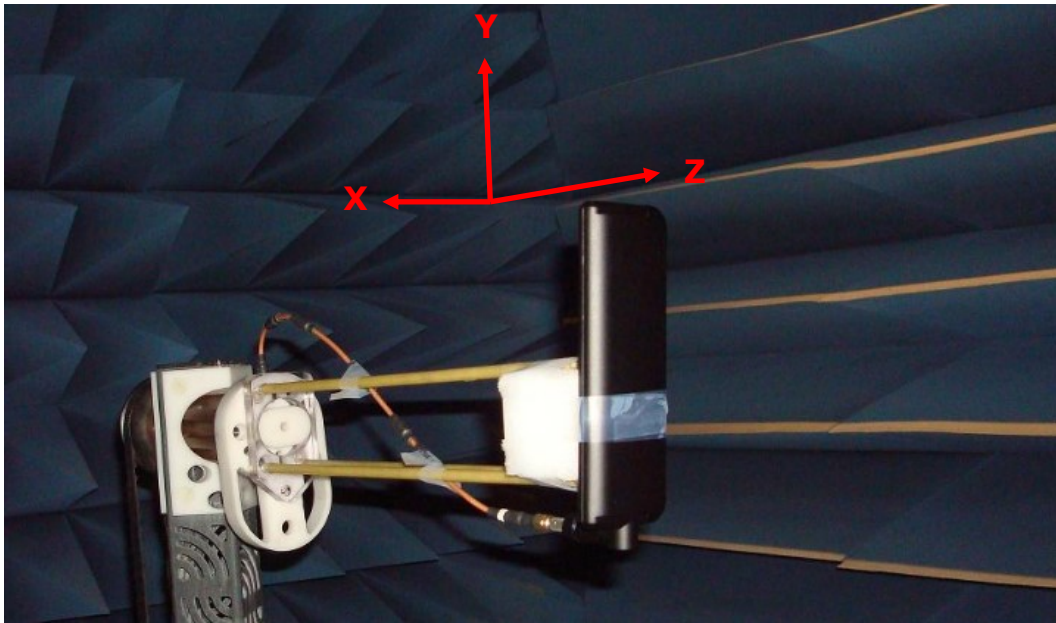

4.2 Radiation Patterns (Free Space)

XY Plane

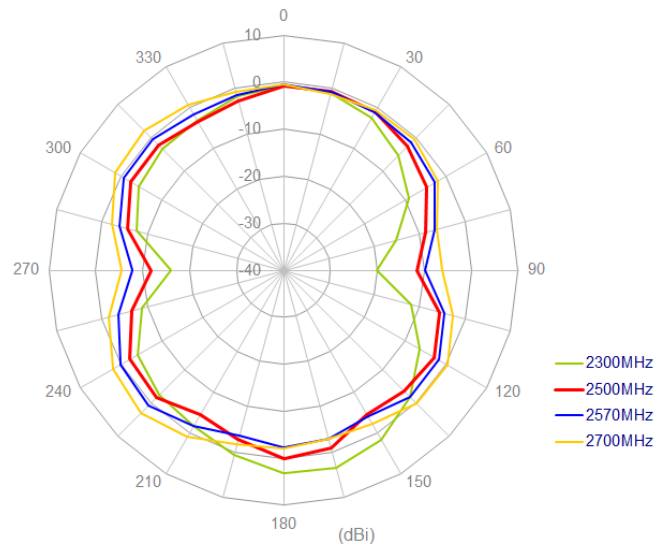
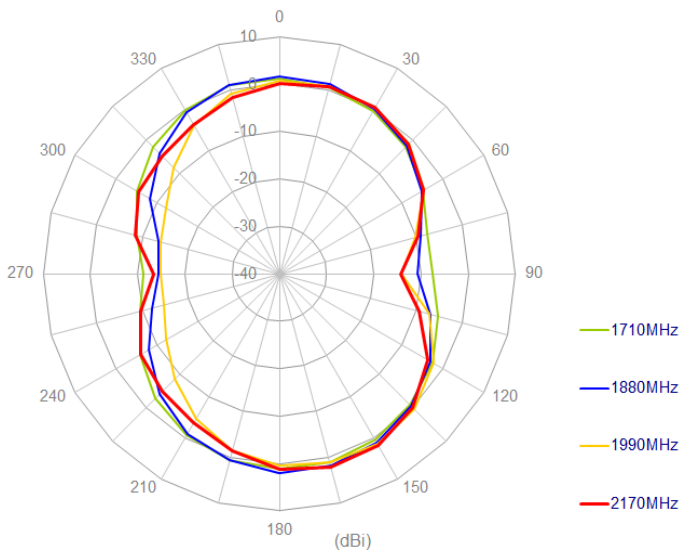
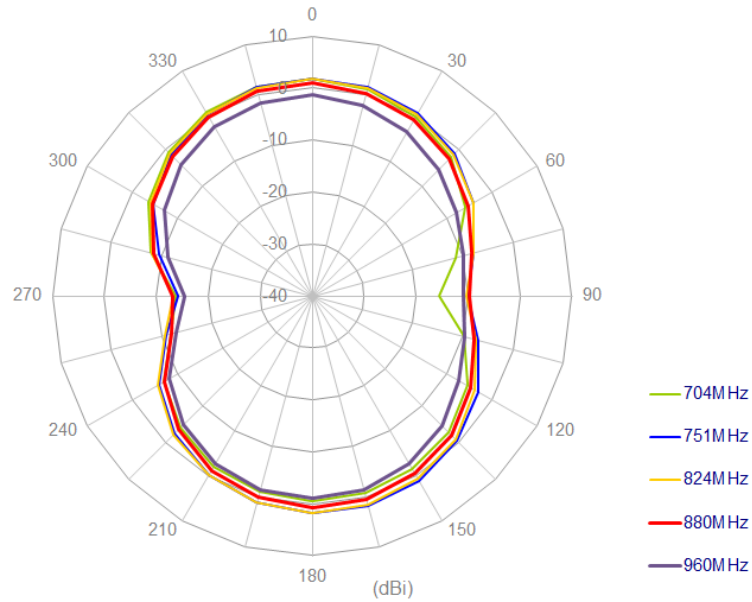

XZ Plane

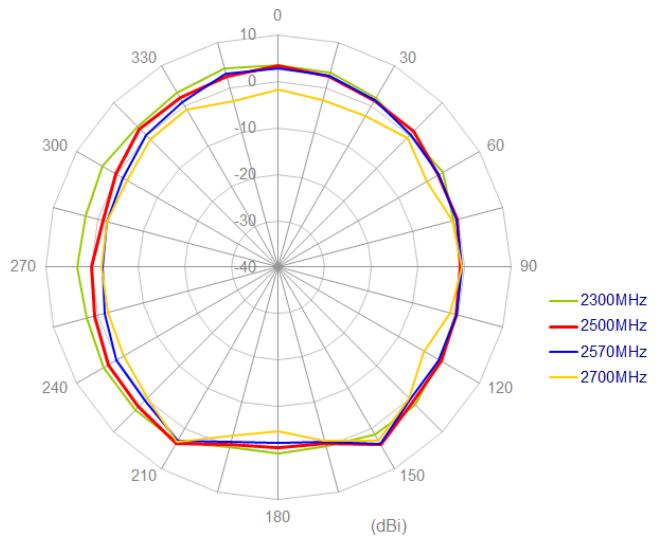
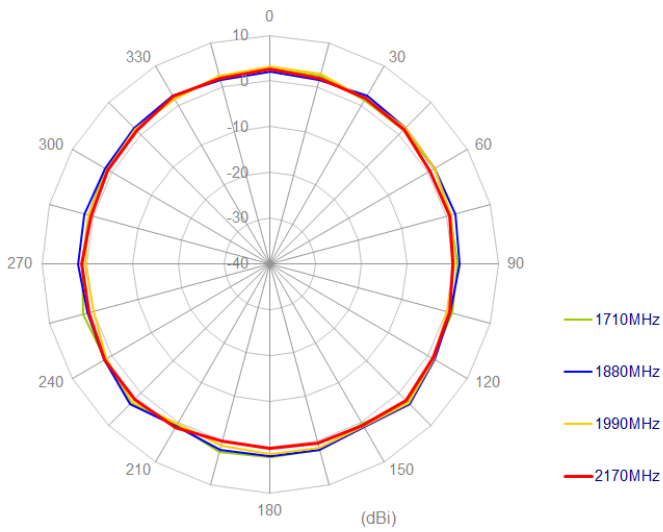
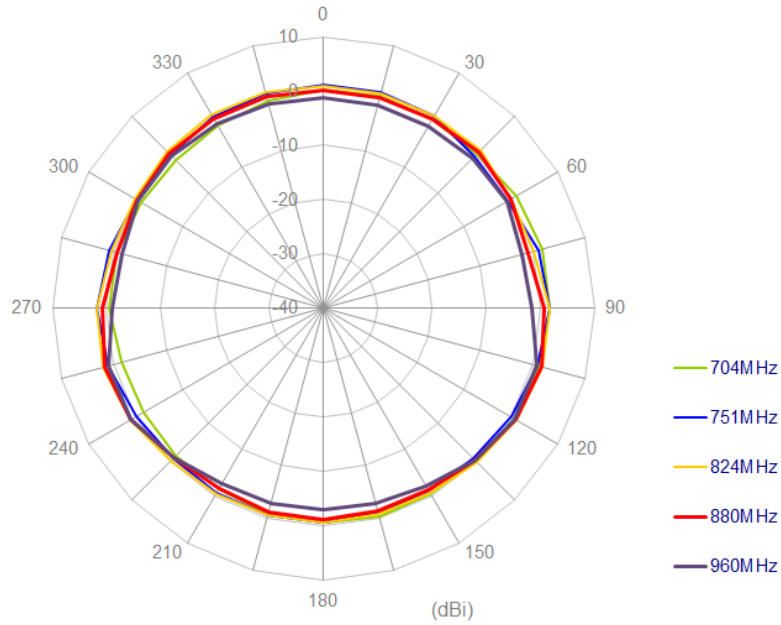

4.3 Antenna setup (On 300x300mm ground center)

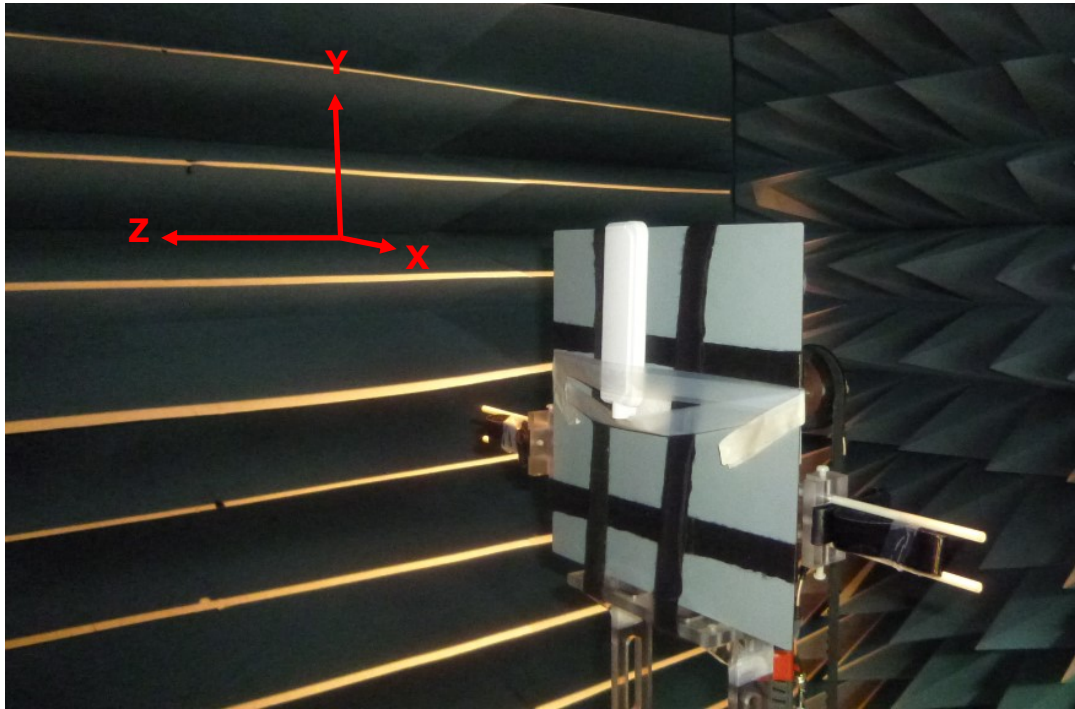

4.4 Radiation Patterns (On 300x300mm ground center)

XY Plane

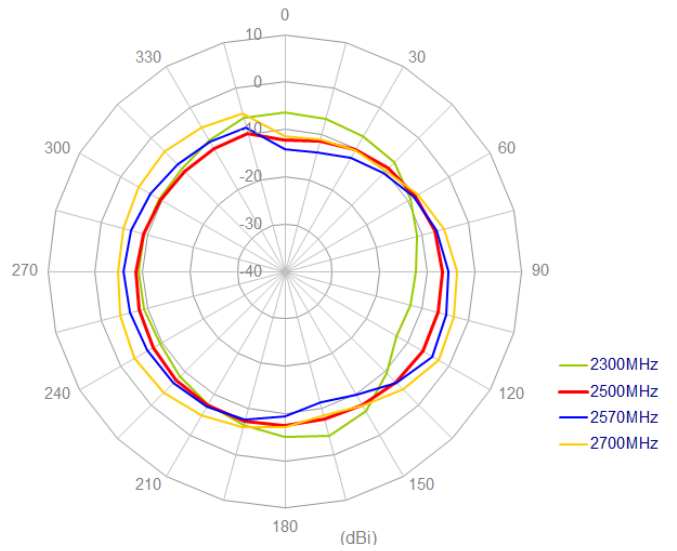
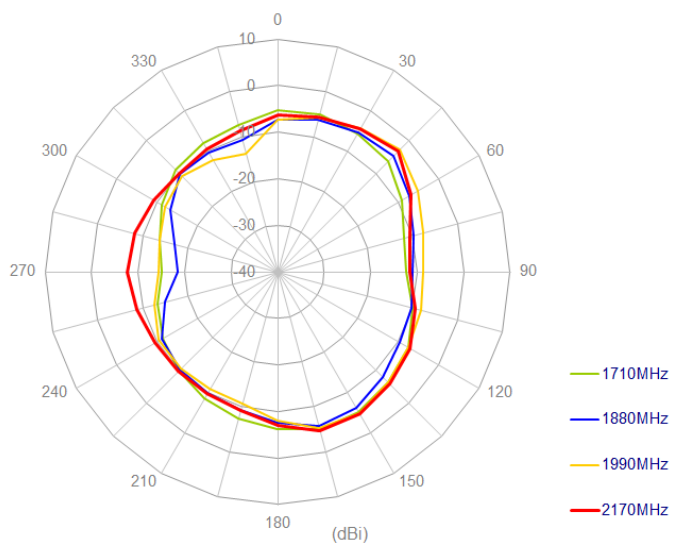
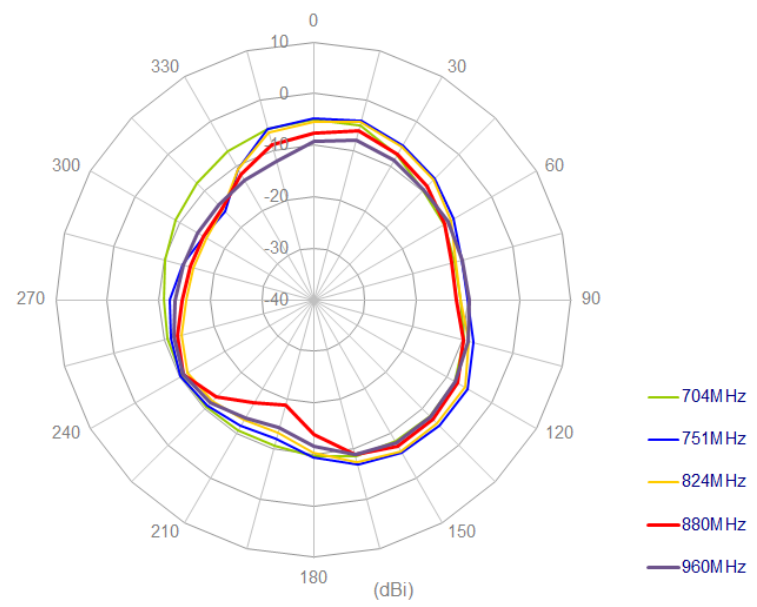

XZ Plane

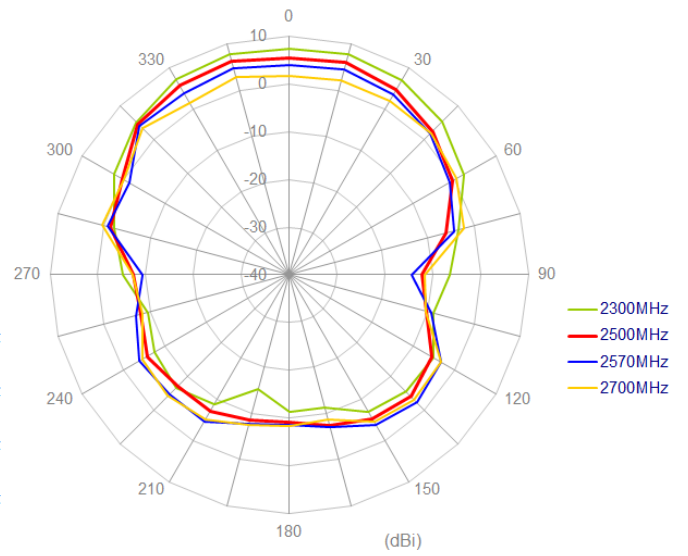
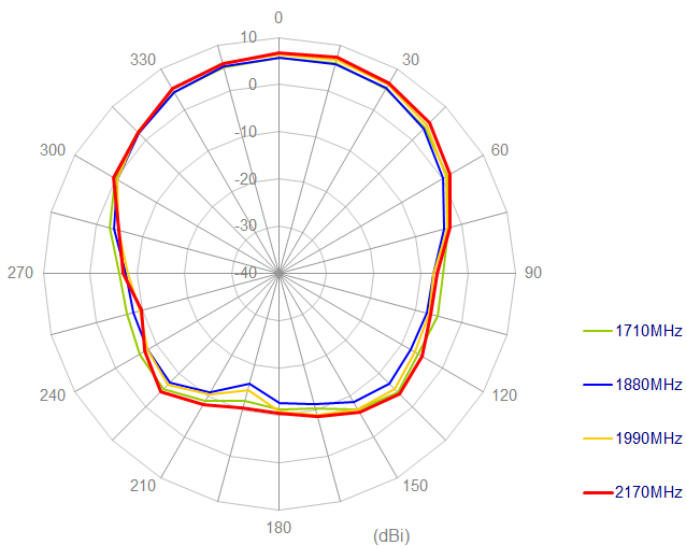
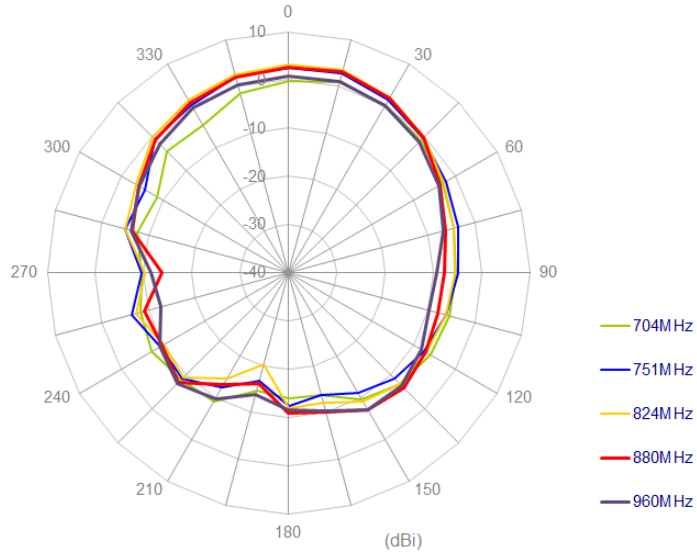

4.5 Antenna setup (On 300x300mm ground edge)

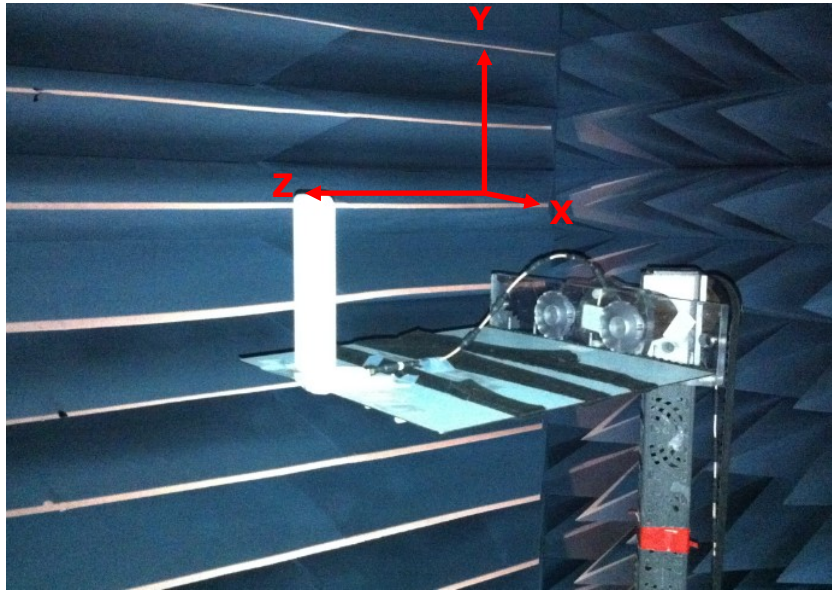

4.6 Radiation Patterns (On 300x300mm ground edge)

XY Plane

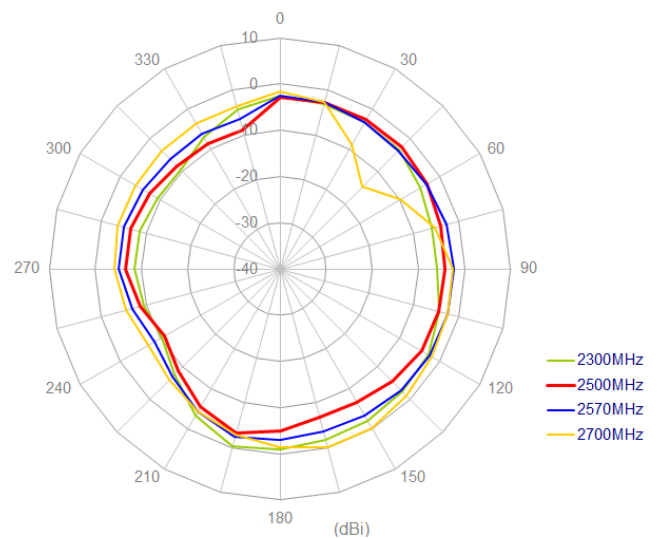
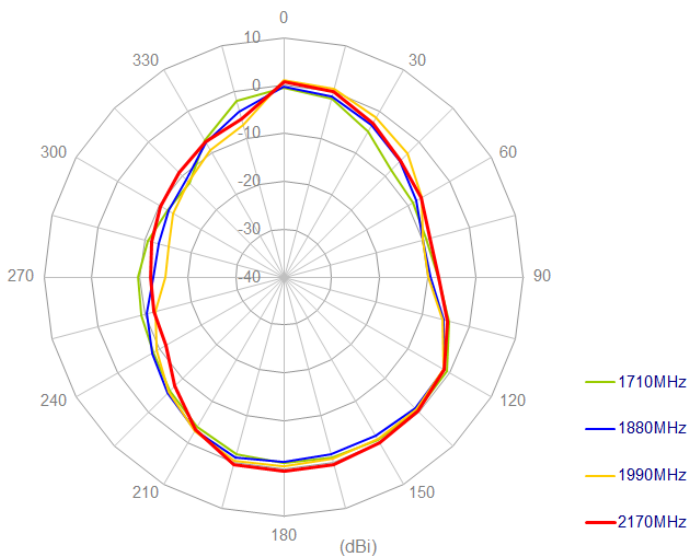
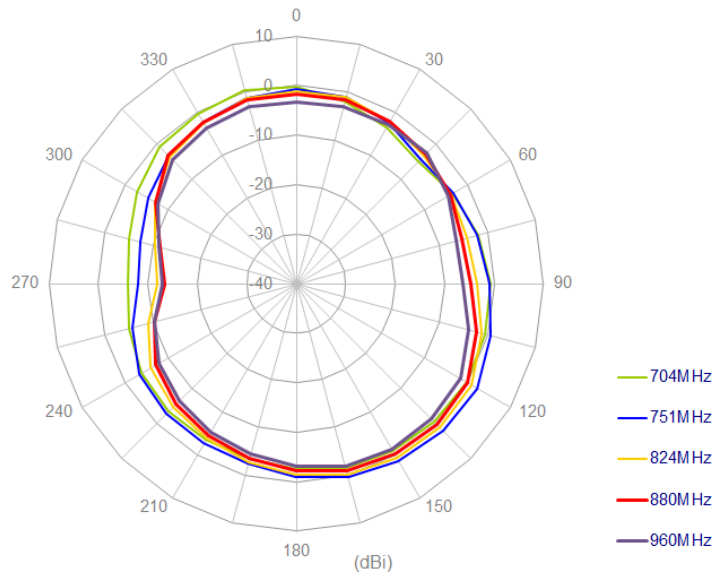

XZ Plane

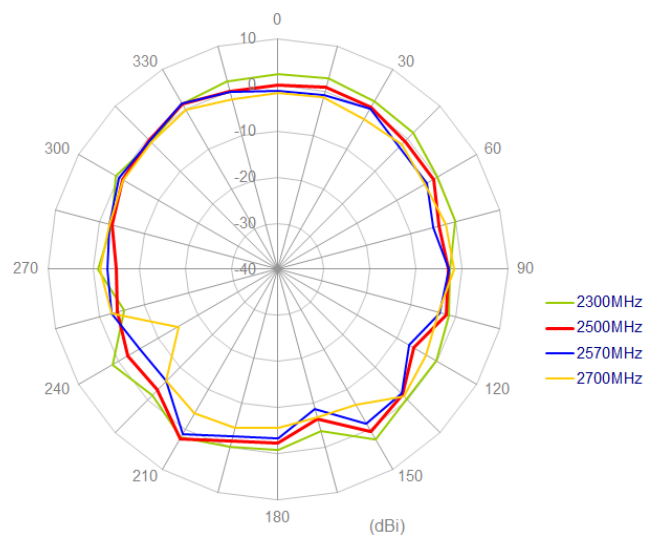
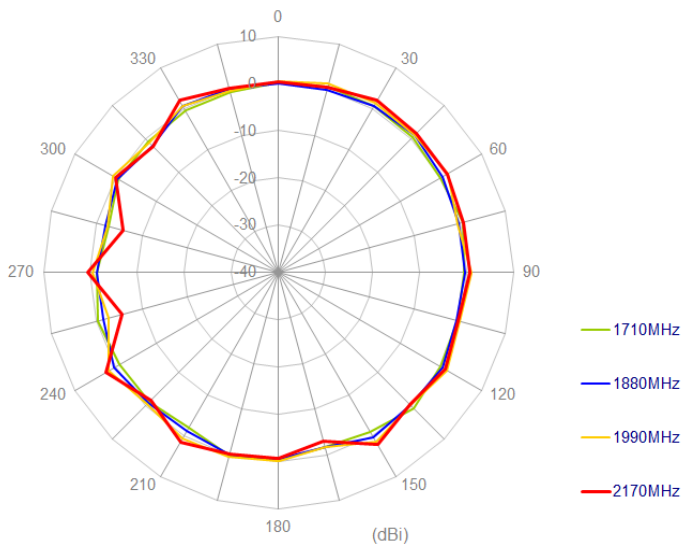
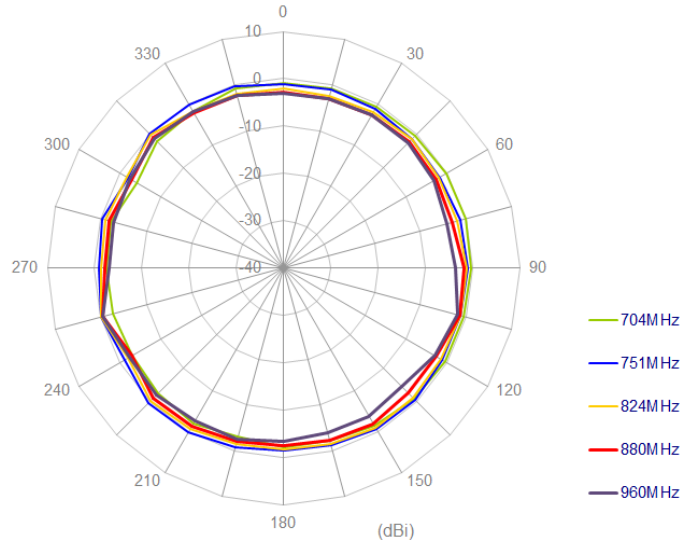

4.7 Antenna setup (On Ground Plane edge)

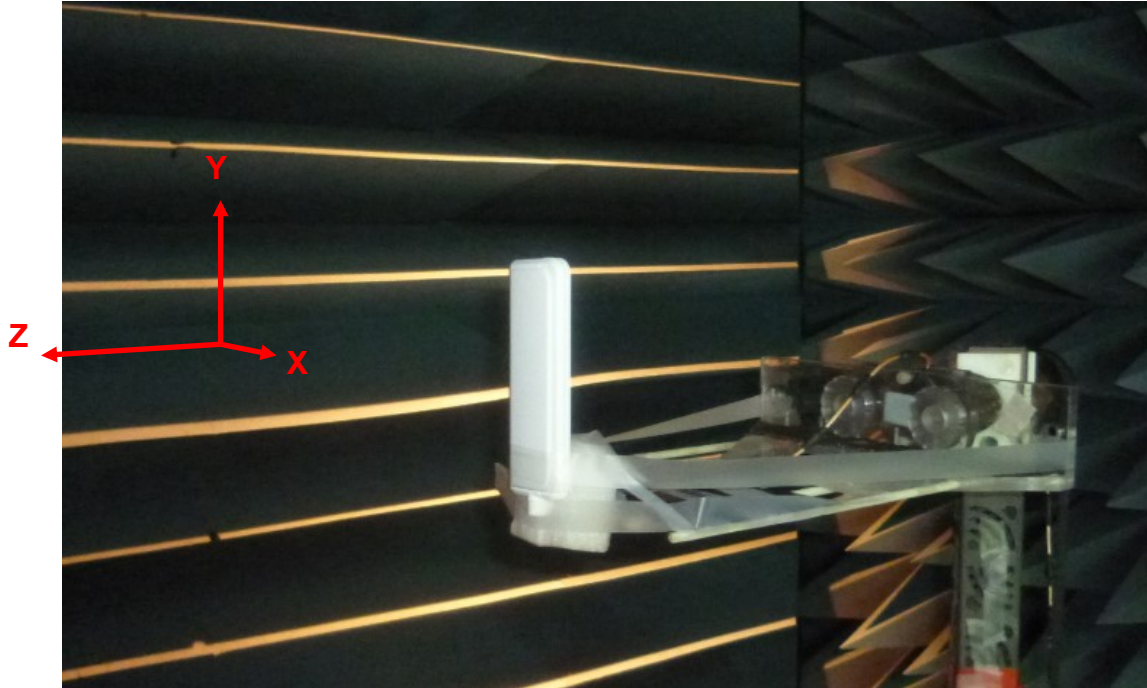

4.8 Radiation Patterns (On Ground Plane edge)

XY Plane

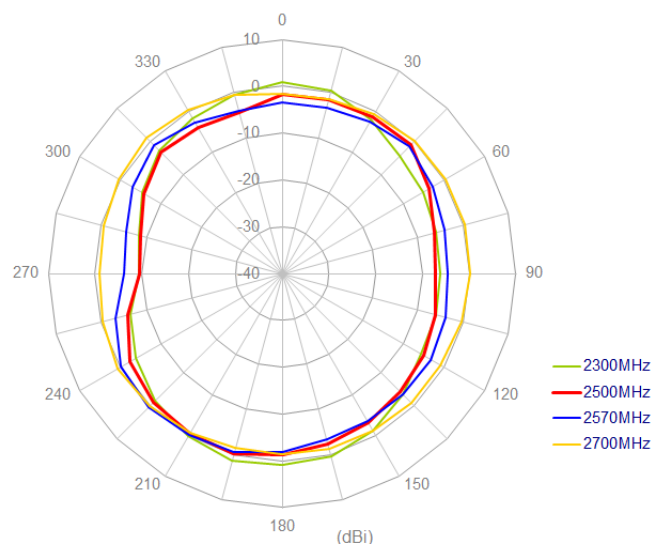
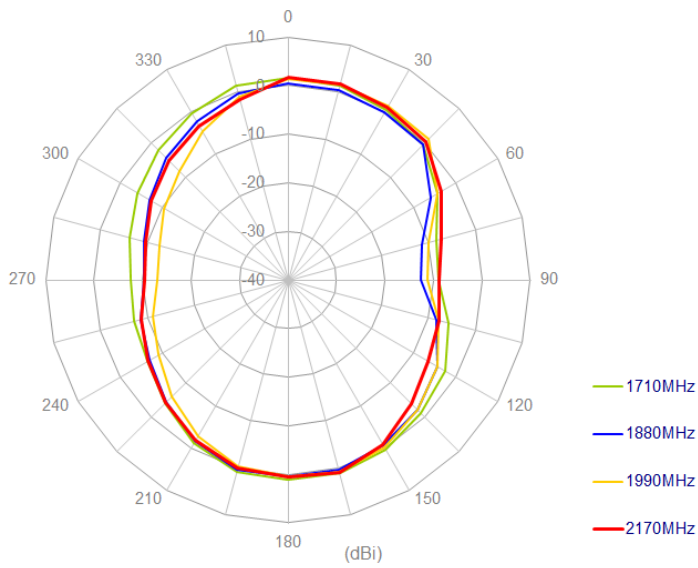
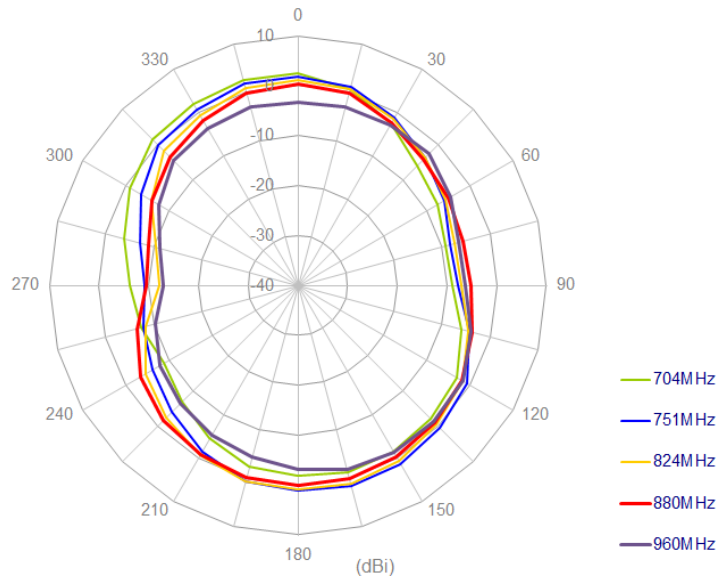

XZ Plane

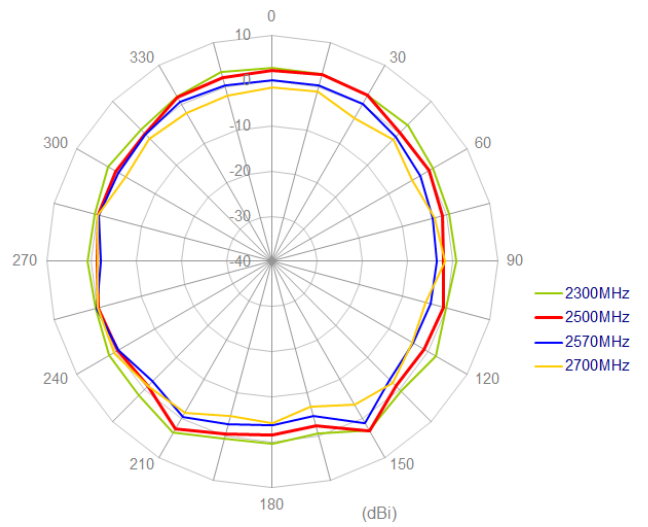
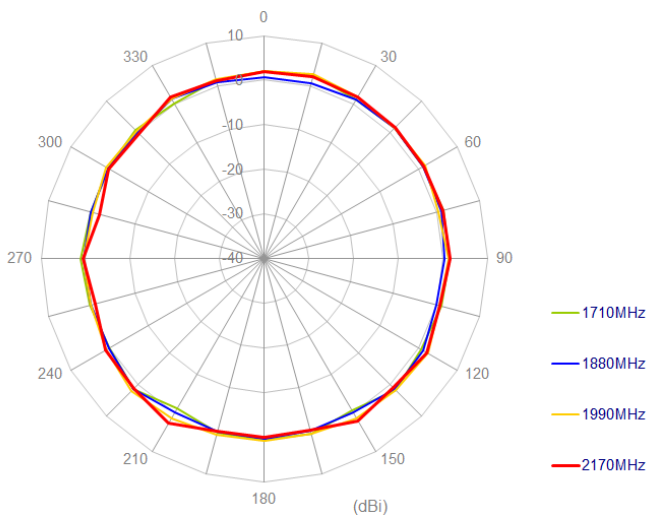
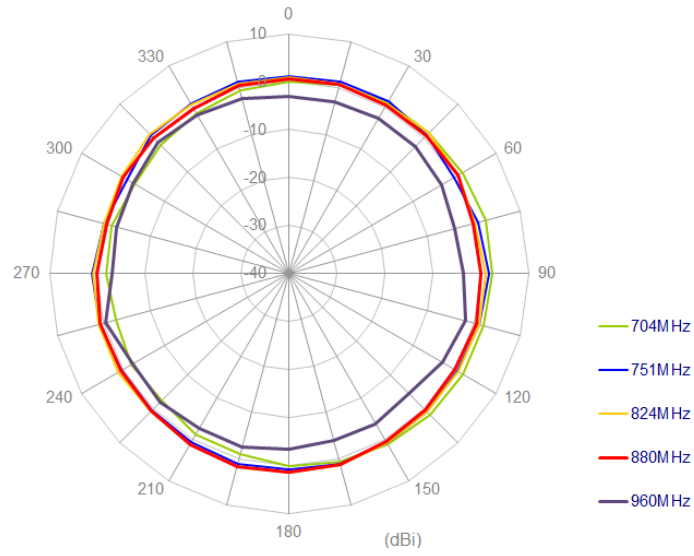

5. Drawing

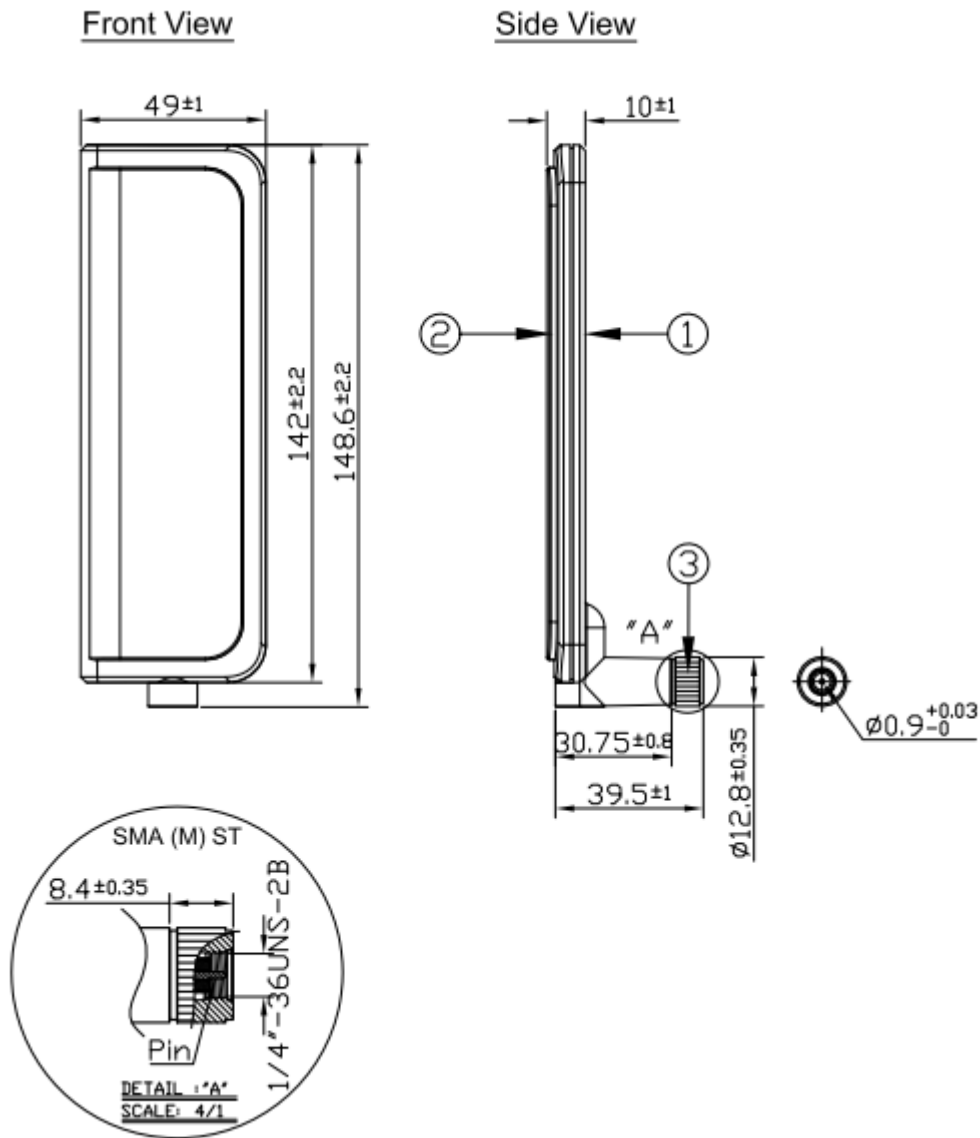

6. Packaging

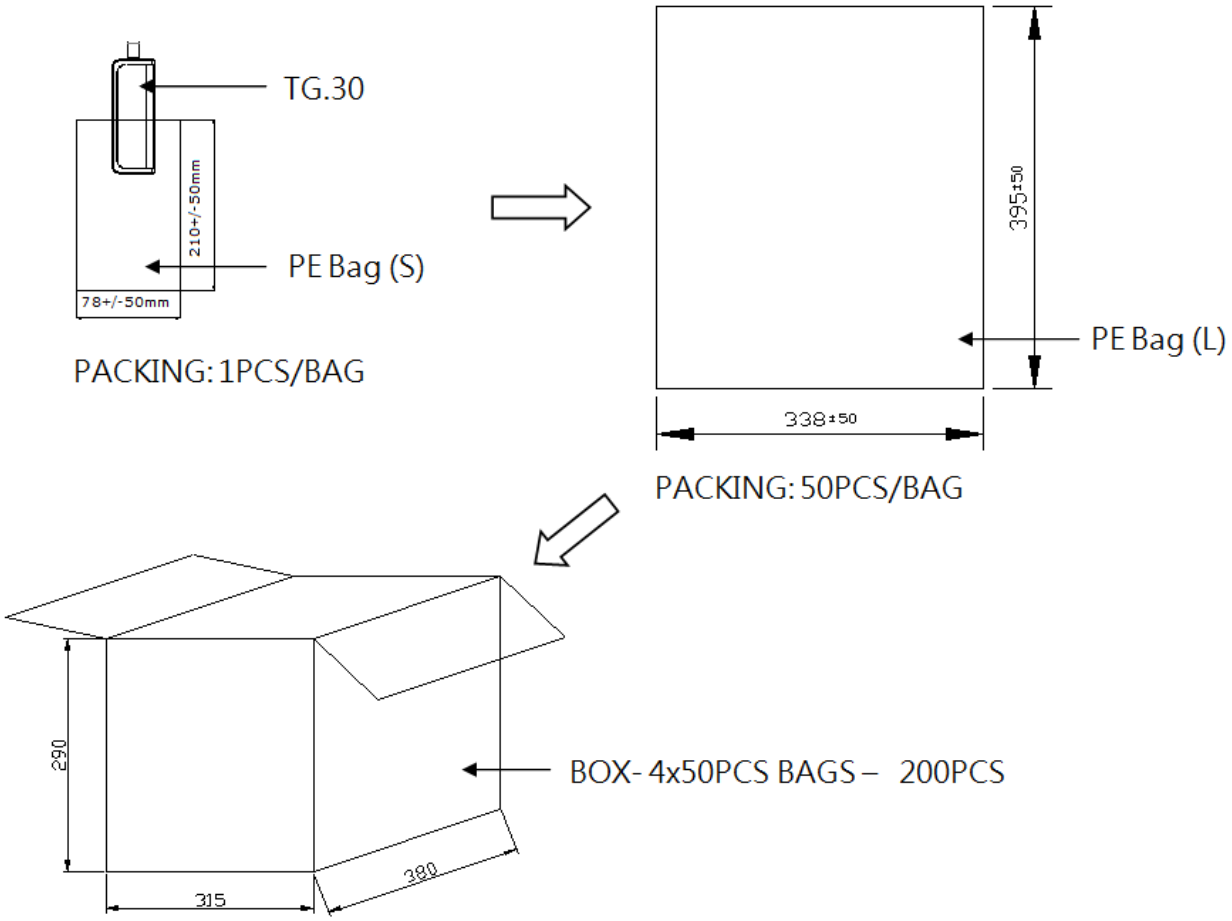

Taoglas makes no warranties based on the accuracy or completeness of the contents of this document and reserves the right to make changes to specifications and product descriptions at any time without notice. Taoglas reserves all rights to this document and the information contained herein. Reproduction, use or disclosure to third parties without express permission is strictly prohibited. Copyright © 2012, Taoglas Ltd.