

# X3G-OH047; X3T-OH047; X3G-OH048; X3T-OH048

Magnetic field sensor

Rev. 1 — 4 April 2011

Product specification

## 1. Product profile

### 1.1 General description

The X3G-OH047, X3G-OH048, X3T-OH047 and X3T-OH048 are sensitive magnetic field sensors, employing the magneto-resistive effect of thin film permalloy. The sensors contain two parallel supplied Wheatstone bridges at a relative angle of 45° to each other.

A rotating magnetic field in the surface parallel to the chip (x-y plane) will deliver two independent sinusoidal output signals, one following a  $\cos(2\alpha)$  and the other following a  $\sin(2\alpha)$  function,  $\alpha$  being the angle between sensor and field direction (see [Figure 5](#) and [Figure 6](#)).

The X3G-OH047, X3G-OH048, X3T-OH047 and X3T-OH048 are suited for high precision angle measurement applications under low field conditions (saturation field strength 25 kA/m).

The sensors can be operated at any frequency between DC and 1 MHz.

All type numbers shown in this data sheet are valid for a single-die (single sensor). The double-die has two magnetic field sensors with electrical and magnetic parameters which fulfill the specified single-die values and do not correlate to each other.

**Table 1. Product overview**

Type number	Sensor	Packing
X3G-OH047	double-die	sawn wafer; on foil
X3G-OH048	single-die	sawn wafer; on foil
X3T-OH047	double-die	taped on reel
X3T-OH048	single-die	taped on reel



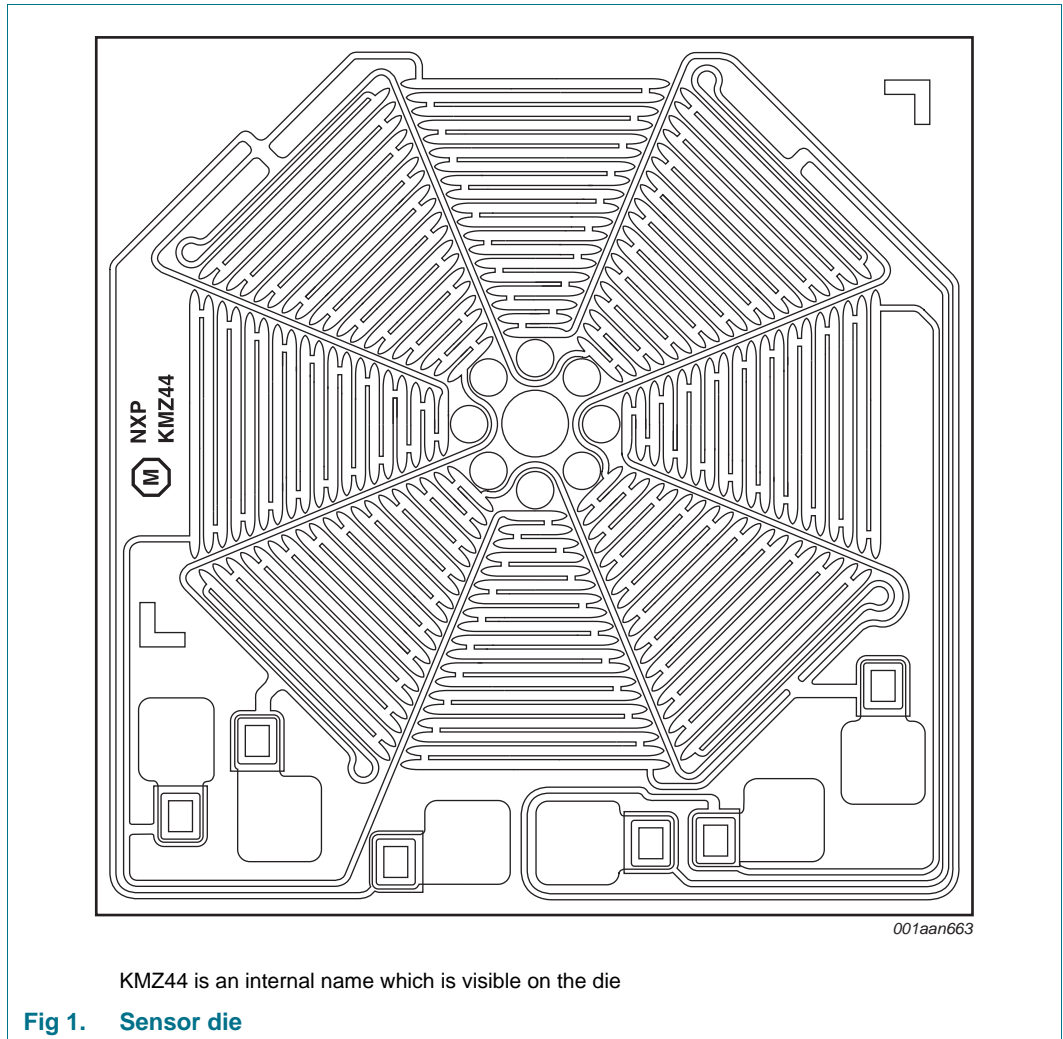

## 1.2 Features and benefits

- Accurate and reliable angle measurement
- Mechanical robustness, contactless principle
- Wear-free operation
- Accuracy independent of mechanical tolerances
- Extended temperature range

## 1.3 Applications

- |                              |                      |
|------------------------------|----------------------|
| ■ Steering angle and torsion | ■ Window wipers      |
| ■ Headlight adjustment       | ■ Fuel level         |
| ■ Motor positioning          | ■ Mirror positioning |

1.4 Quick reference data

Table 2. Quick reference data

$T_{amb} = 25\text{ }^{\circ}\text{C}$ ;  $H_{ext} = 25\text{ kA/m}$ ;  $V_{CC} = 5\text{ V}$ ; unless otherwise specified.

Symbol	Parameter	Conditions	Min	Typ	Max	Unit
$V_{CC}$	supply voltage		-	5	9	V
$V_M$	peak voltage	see Figure 3	[1][2] 60	67	75	mV
$V_{offset}$	offset voltage	per supply voltage; see Figure 3	[1] -2	-	+2	mV/V
$TC_{V(offset)}$	offset voltage temperature coefficient	per supply voltage; $T_{amb} = -40\text{ }^{\circ}\text{C}$ to $+150\text{ }^{\circ}\text{C}$ ; see Figure 3	[1][3] -2	-	+2	( $\mu\text{V/V}$ )/K
$R_{bridge}$	bridge resistance		[1][4] 2.7	3.2	3.7	k $\Omega$

- [1] Applicable for bridge 1 and bridge 2.
- [2]  $V_M = |V_{O(max)} - V_{offset}|$ . Periodicity of  $V_M$ :  $\sin(2\alpha)$  and  $\cos(2\alpha)$ , respectively.
- [3]  $TC_{V(offset)} = \frac{V_{offset}(at\ 150\text{ }^{\circ}\text{C}) - V_{offset}(at\ -40\text{ }^{\circ}\text{C})}{150\text{ }^{\circ}\text{C} - (-40\text{ }^{\circ}\text{C})}$
- [4] Bridge resistance between pad 5 to pad 1 and pad 4 to pad 2.

2. Pinning information

Table 3. Pinning

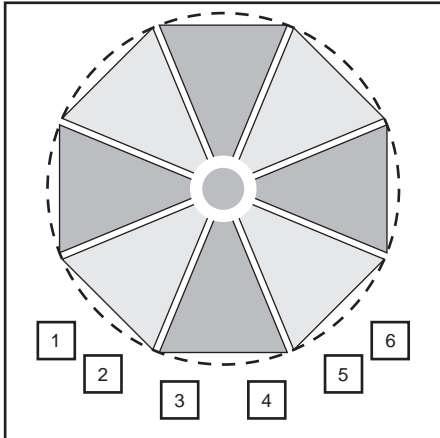
Pad	Symbol	Description	Simplified outline
1	ON1	output voltage bridge 1	
2	ON2	output voltage bridge 2	
3	GND	common ground	
4	OP2	output voltage bridge 2	
5	OP1	output voltage bridge 1	
6	$V_{CC}$	common bridge supply voltage	

001aan662

### 3. Ordering information

Table 4. Ordering information

Type number	Package		
	Name	Description	Version
X3G-OH047	bare die	double-die; sawn wafer; on foil	OL-X3G-OH047
X3G-OH048	bare die	single-die; sawn wafer; on foil	OL-X3G-OH048
X3T-OH047	bare die	double-die; taped on reel	OL-X3T-OH047
X3T-OH048	bare die	single-die; taped on reel	OL-X3T-OH048

### 4. Circuit diagram

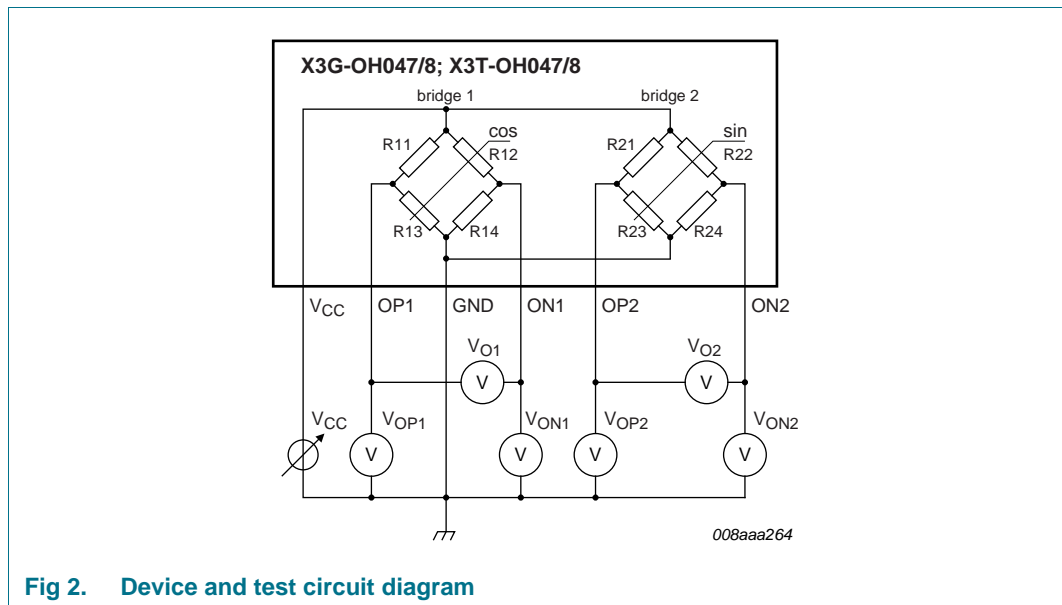

Fig 2. Device and test circuit diagram

### 5. Limiting values

Table 5. Limiting values

In accordance with the Absolute Maximum Rating System (IEC 60134).

Symbol	Parameter	Conditions	Min	Max	Unit
$V_{CC}$	supply voltage		-	9	V
$H_{ext}$	external magnetic field strength	[1]	25	-	kA/m
$T_{amb}$	ambient temperature		-40	+150	°C

[1] Minimum stimulating magnetic field parallel to the chip surface (x-y plane) to achieve specified angular accuracy.

## 6. Characteristics

**Table 6. Characteristics**

$T_{amb} = 25\text{ °C}$ ;  $H_{ext} = 25\text{ kA/m}$ <sup>[1]</sup>;  $V_{CC} = 5\text{ V}$ ; unless otherwise specified.

Symbol	Parameter	Conditions	Min	Typ	Max	Unit
$V_{CC}$	supply voltage		-	5	9	V
$V_M$	peak voltage	see <a href="#">Figure 3</a>	<a href="#">[2][3]</a> 60	67	75	mV
$TC_{VM}$	peak voltage temperature coefficient	$T_{amb} = -40\text{ °C to }+150\text{ °C}$	<a href="#">[2][4]</a> -0.30	-0.36	-0.42	%/K
$R_{bridge}$	bridge resistance		<a href="#">[2][5]</a> 2.7	3.2	3.7	k $\Omega$
$TC_{R(bridge)}$	bridge resistance temperature coefficient	$T_{amb} = -40\text{ °C to }+150\text{ °C}$	<a href="#">[2][6]</a> 0.24	0.27	0.29	%/K
$V_{offset}$	offset voltage	per supply voltage; see <a href="#">Figure 3</a>	<a href="#">[2]</a> -2	-	+2	mV/V
$TC_{V(offset)}$	offset voltage temperature coefficient	per supply voltage; $T_{amb} = -40\text{ °C to }+150\text{ °C}$ ; see <a href="#">Figure 3</a>	<a href="#">[2][7]</a> -2	-	+2	( $\mu\text{V/V}$ )/K
$V_{o(hys)}$	hysteresis output voltage	see <a href="#">Figure 4</a>	<a href="#">[2][8]</a> 0	0.05	0.18	%FS
$\omega$	angular velocity		0	-	1	MHz
$k$	amplitude synchronism		<a href="#">[9]</a> 98.9	100	101.1	%
$TC_k$	amplitude synchronism temperature coefficient	$T_{amb} = -40\text{ °C to }+150\text{ °C}$	<a href="#">[10]</a> -0.01	0	+0.01	%/K
$\Delta\alpha$	angular inaccuracy		<a href="#">[11]</a> 0	0.05	0.1	deg

[1] Minimum stimulating magnetic field parallel to the chip surface (x-y plane) to achieve angular inaccuracy.

[2] Applicable for bridge 1 and bridge 2.

[3]  $V_M = |V_{O(max)} - V_{offset}|$ . Periodicity of  $V_M$ :  $\sin(2\alpha)$  and  $\cos(2\alpha)$ , respectively.

$$[4] \quad TC_{VM} = \frac{V_M(at\ 150\text{ °C}) - V_M(at\ -40\text{ °C})}{V_M(at\ 25\text{ °C}) \times (150\text{ °C} - (-40\text{ °C}))}$$

[5] Bridge resistance between pad 5 to pad 1 and pad 4 to pad 2.

$$[6] \quad TC_{R(bridge)} = \frac{R_{bridge}(at\ 150\text{ °C}) - R_{bridge}(at\ -40\text{ °C})}{R_{bridge}(at\ 25\text{ °C}) \times (150\text{ °C} - (-40\text{ °C}))}$$

$$[7] \quad TC_{V(offset)} = \frac{V_{offset}(at\ 150\text{ °C}) - V_{offset}(at\ -40\text{ °C})}{150\text{ °C} - (-40\text{ °C})}$$

$$[8] \quad V_{o(hys)1} = \left| \frac{V_{O1}(67.5^\circ)135^\circ \rightarrow 45^\circ - V_{O1}(67.5^\circ)45^\circ \rightarrow 135^\circ}{2 \times V_{M1}} \right|$$

$$V_{o(hys)2} = \left| \frac{V_{O2}(22.5^\circ)90^\circ \rightarrow 0^\circ - V_{O2}(22.5^\circ)0^\circ \rightarrow 90^\circ}{2 \times V_{M2}} \right|$$

$$[9] \quad k = \frac{V_{M1}}{V_{M2}}$$

$$[10] \quad TC_k = \frac{k(at\ 150\text{ °C}) - k(at\ -40\text{ °C})}{k(at\ 25\text{ °C}) \times (150\text{ °C} - (-40\text{ °C}))}$$

[11]  $\Delta\alpha = |\alpha_{real} - \alpha_{meas}|$ ;  $V_{offset} = 0\text{ V}$ ; inaccuracy of angular measurement due to deviations from ideal sinusoidal characteristics, calculated from the third and fifth harmonics of the spectrum  $V_O$ .

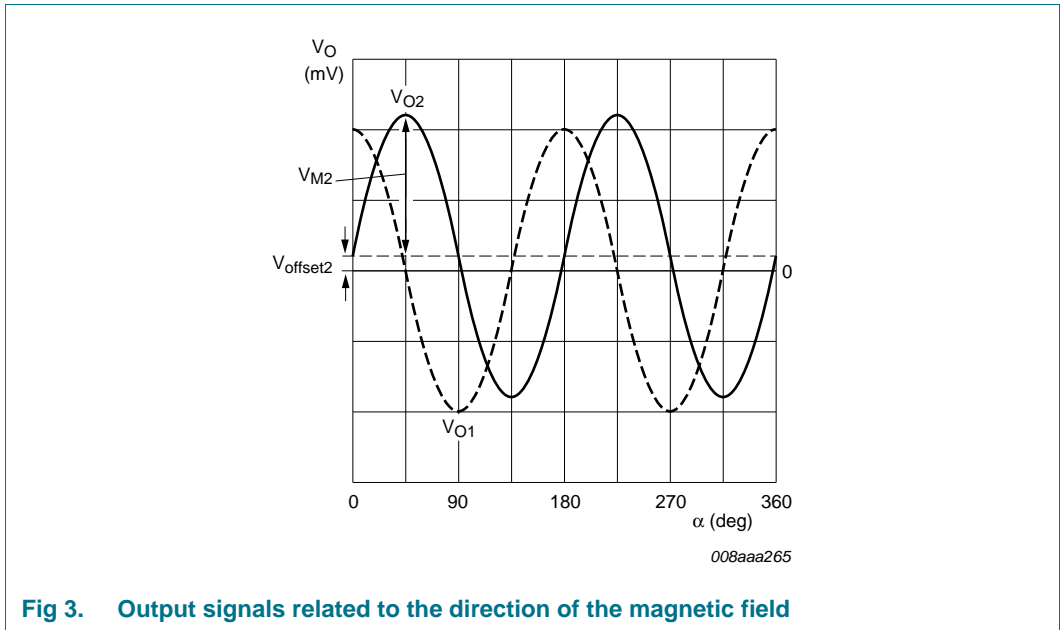

Fig 3. Output signals related to the direction of the magnetic field

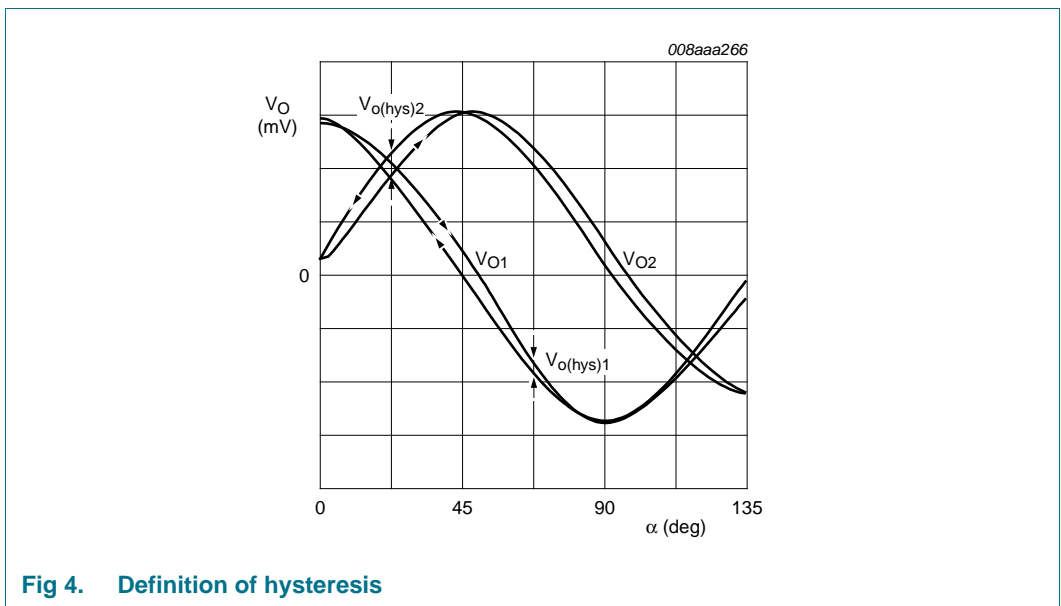

Fig 4. Definition of hysteresis

7. Bare die outline

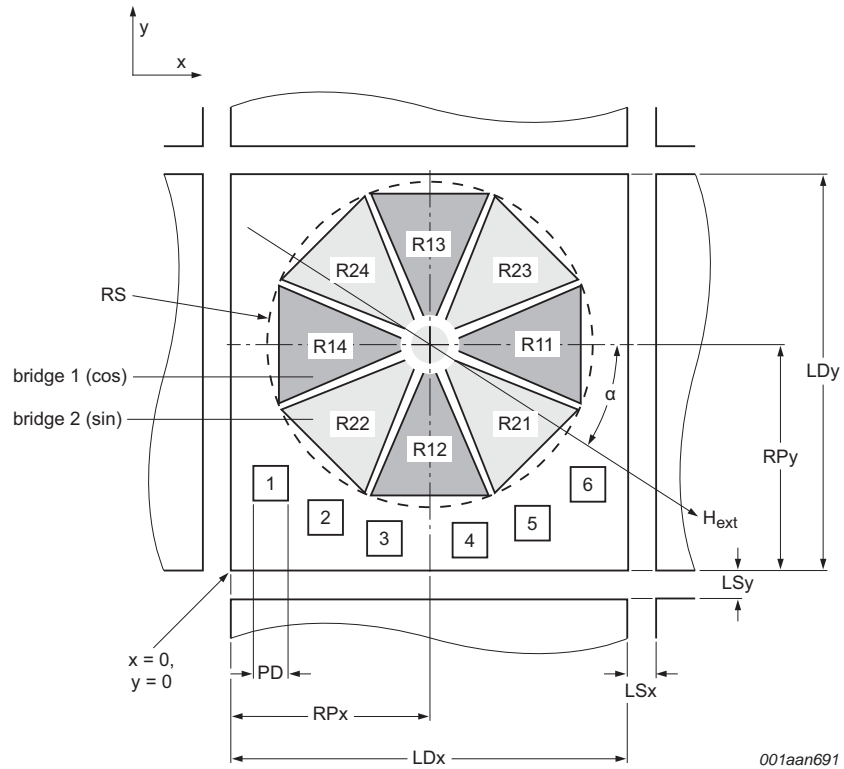
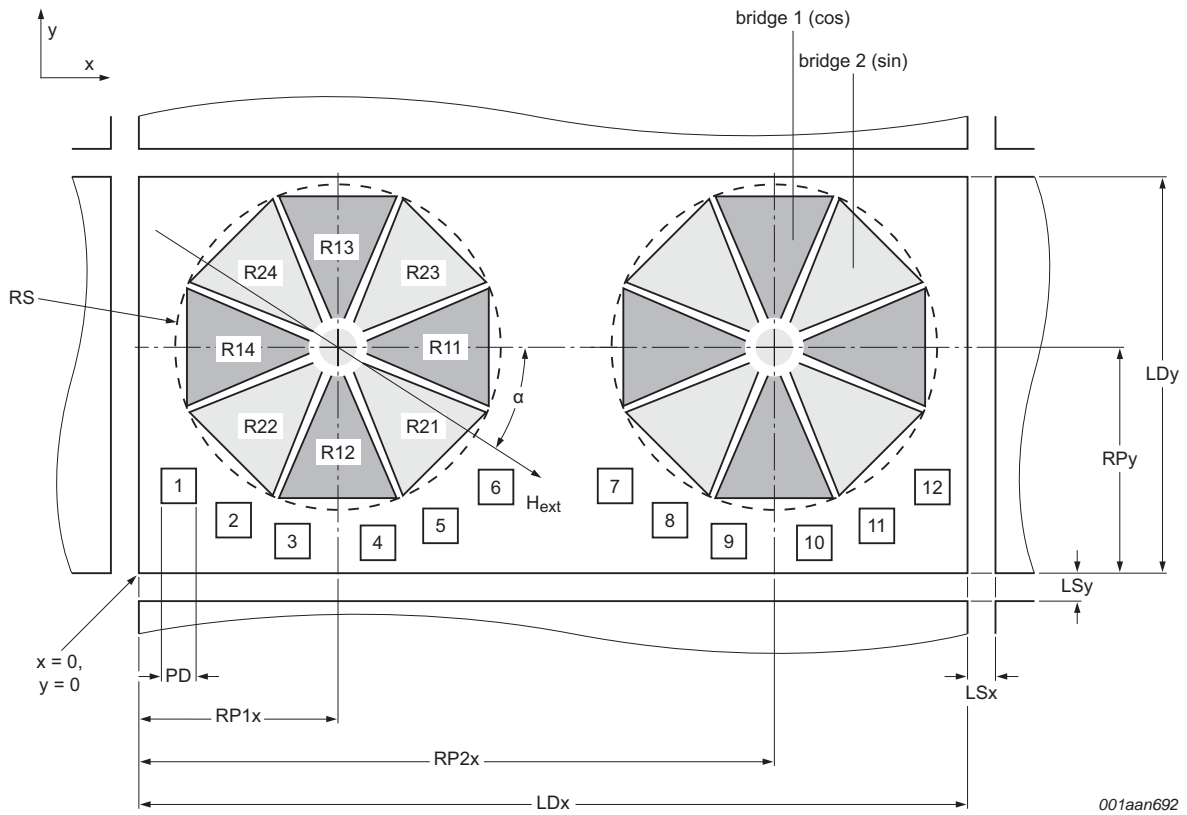

Fig 5. Bare die outline (single die)

Table 7. Mechanical dimensions for Figure 5

Symbol	Parameter	x	y	Radius/diameter	Unit
LD	die size	1150	1150	-	$\mu\text{m}$
LS	sawing lane width	60	60	-	$\mu\text{m}$
RP	reading point position	575	642	-	$\mu\text{m}$
RS	sensitive area radius	-	-	480	$\mu\text{m}$
PD	pad diameter	-	-	110	$\mu\text{m}$
1	position pad 1	108	230	-	$\mu\text{m}$
2	position pad 2	243	125	-	$\mu\text{m}$
3	position pad 3	489	95	-	$\mu\text{m}$
4	position pad 4	632	95	-	$\mu\text{m}$
5	position pad 5	900	125	-	$\mu\text{m}$
6	position pad 6	1032	200	-	$\mu\text{m}$



001aan692

Fig 6. Bare die outline (double die)

Table 8. Mechanical dimensions for Figure 6

Symbol	Parameter	x	y	Radius/diameter	Unit
LD	die size	2360	1150		μm
LS	sawing lane width	60	60		μm
RP1	reading point position 1	575	642		μm
RP2	reading point position 2	1785	642		μm
RS	sensitive area radius	-	-	480	μm
PD	pad diameter	-	-	110	μm
1	position pad 1	108	230		μm
2	position pad 2	243	125		μm
3	position pad 3	489	95		μm
4	position pad 4	632	95		μm
5	position pad 5	900	125		μm
6	position pad 6	1032	200		μm
7	position pad 7	1318	230		μm
8	position pad 8	1453	125		μm
9	position pad 9	1699	95		μm



**Table 8. Mechanical dimensions for Figure 6 ...continued**

Symbol	Parameter	x	y	Radius/diameter	Unit
10	position pad 10	1842	95		μm
11	position pad 11	2110	125		μm
12	position pad 12	2242	200		μm

**Table 9. Wafer dimensions**

Symbol	Parameter	Value	Unit
WD	wafer diameter	150	mm
WT	wafer thickness	380 ± 15	μm

## 8. Packing information

### 8.1 Tape construction for X3G-OH047 and X3G-OH048

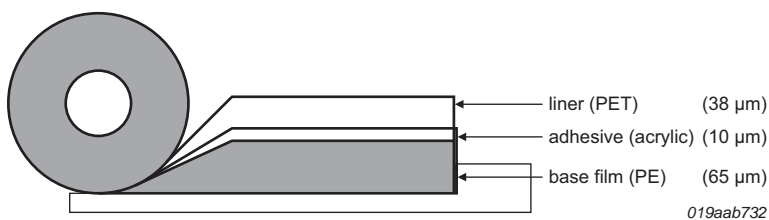
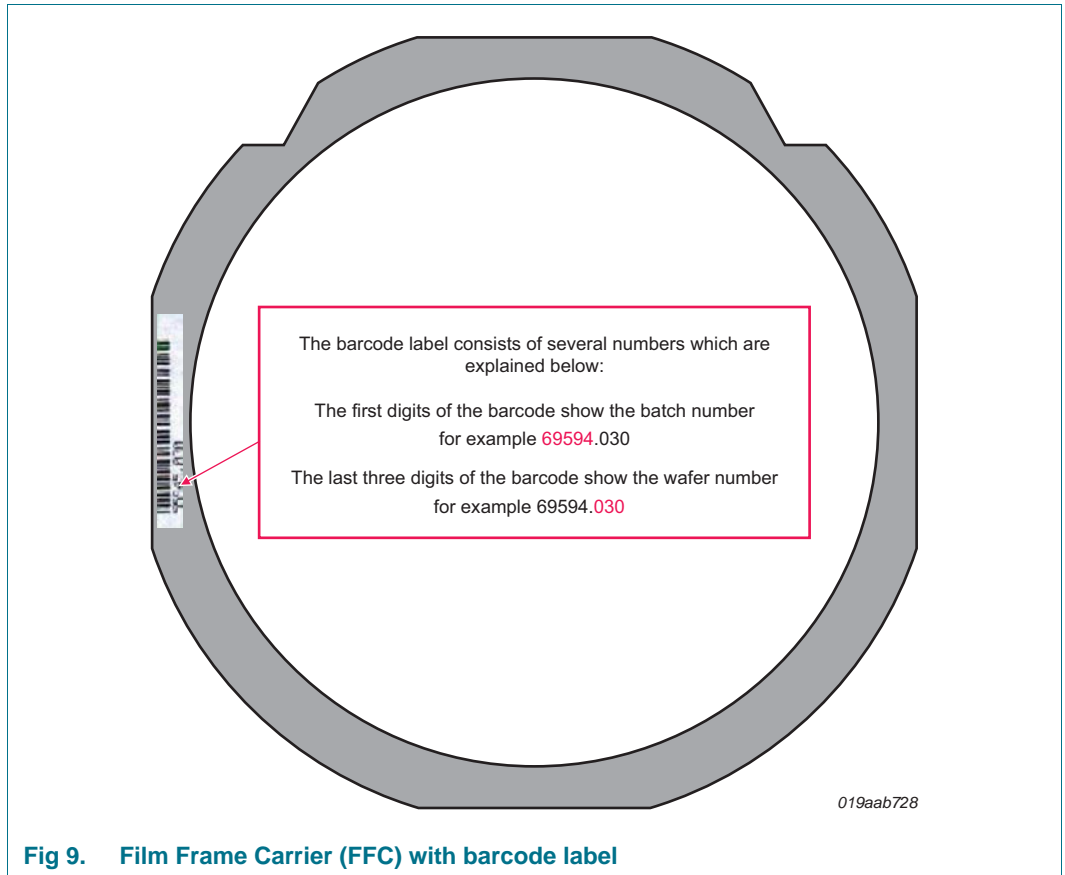

**Fig 7. Tape construction**

**Table 10. Material composition**

Parameter	Content	Typical value	Unit
Total thickness	-	75	μm
Adhesion	-	55 / 20	g/mm
Ionic impurity	Na <sup>+</sup>	0.027	μg/ml
	K <sup>+</sup>	< 0.004	μg/ml
	Cl	0.045	μg/ml





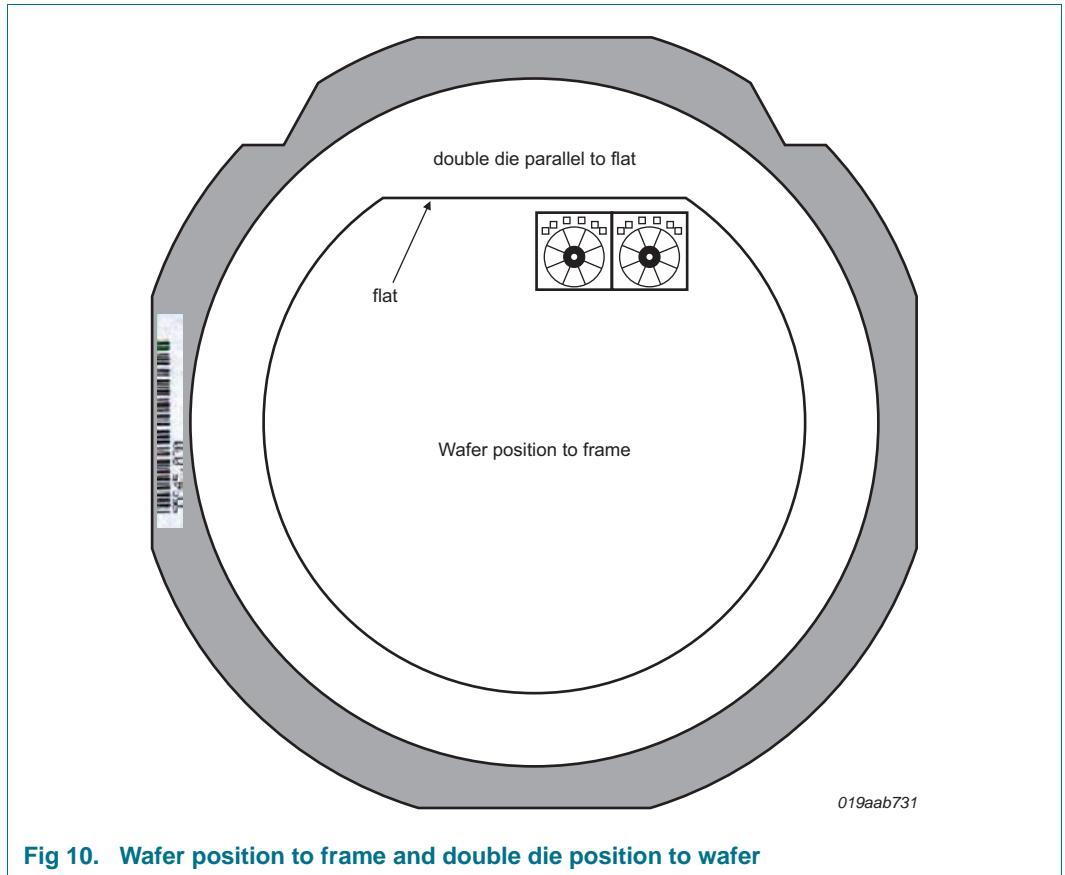

**Fig 10. Wafer position to frame and double die position to wafer**

8.2 Carrier tape for X3T-OH047 and X3T-OH048

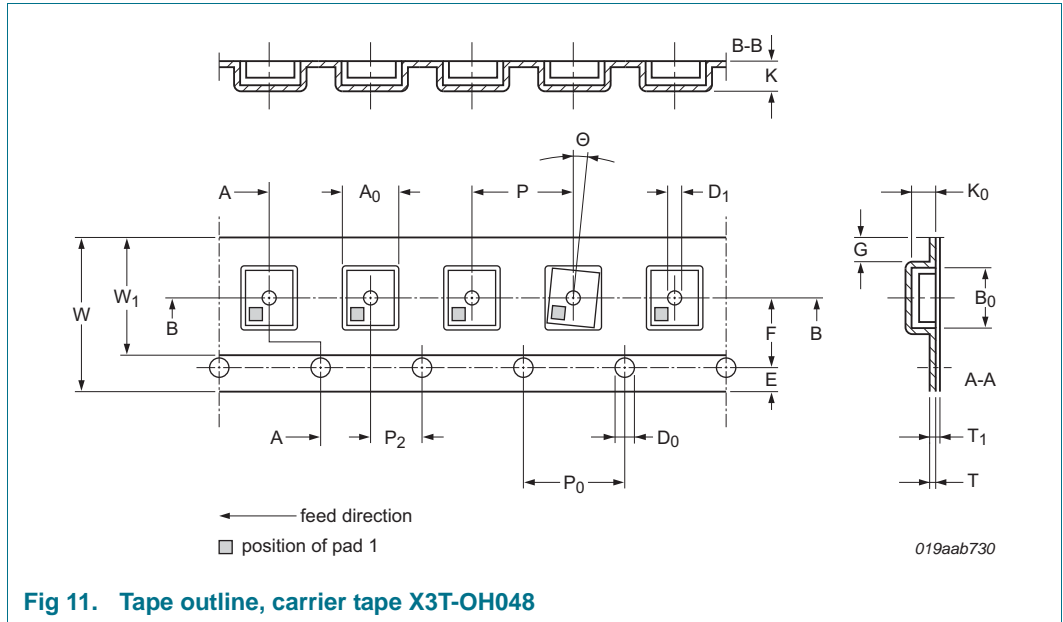

Fig 11. Tape outline, carrier tape X3T-OH048

Table 11. Dimensions for Figure 11 “Tape outline, carrier tape X3T-OH048”

Item	Symbol	Specification	
		Dimension [mm]	Tolerance
<b>Overall dimensions</b>			
Tape width	W	8	±0.1
Thickness	K	≤ 1.2	-
Distance	G	≥ 0.75	-
<b>Sprocket holes</b>			
Diameter	D <sub>0</sub>	1.5	±0.1
Distance	E	1.75	±0.1
Pitch <sup>[1]</sup>	P <sub>0</sub>	4	±0.1
<b>Distance between center lines</b>			
Length direction	P <sub>2</sub>	2	±0.05
Width direction	F	3.5	±0.05
<b>Compartments</b>			
Length	A <sub>0</sub>	1.4	±0.05
Width	B <sub>0</sub>	1.4	±0.05
Depth	K <sub>0</sub>	0.8	±0.05
Hole diameter	D <sub>1</sub>	0.5	±0.1
Pitch	P	4	±0.1
<b>Device</b>			
Outline	X3T-OH048		
Rotation	Θ	≤ 20°	-
<b>Carrier tape antistatic</b>			
Film thickness <sup>[2]</sup>	T	0.25	±0.07

Table 11. Dimensions for [Figure 11 “Tape outline, carrier tape X3T-OH048”](#) ...continued

Item	Symbol	Specification	
		Dimension [mm]	Tolerance
<b>Cover tape</b>			
Width	$W_1$	$\leq 5.75$	-
Film thickness	$T_1$	$\leq 0.1$	-
<b>Bending radius</b>			
In winding direction	$R$	$\geq 30$	-

- [1] Cumulate pitch error  $\pm 0.2$  over 10 pitch.
- [2] Carbon loaded polystyrene 100 % recyclable.

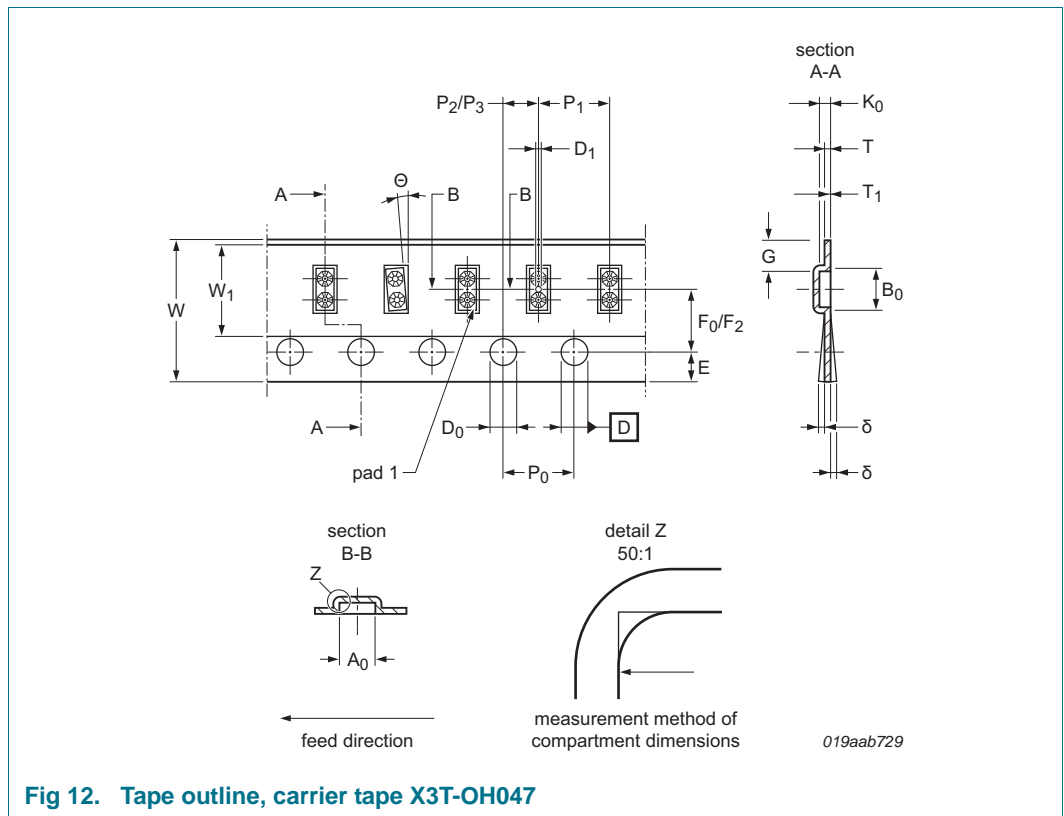

Fig 12. Tape outline, carrier tape X3T-OH047

Table 12. Dimensions for [Figure 12 “Tape outline, carrier tape X3T-OH047”](#)

Item	Symbol	Specification	
		Dimension [mm]	Tolerance
<b>Overall dimensions</b>			
Tape width	$W$	8	$\pm 0.1$
Distance	$G$	$\geq 0.75$	-
<b>Sprocket holes</b>			
Diameter	$D_0$	1.5	$\pm 0.1$
Distance	$E$	1.75	$\pm 0.1$
Pitch <sup>[1]</sup>	$P_0$	4	$\pm 0.1$

Table 12. Dimensions for [Figure 12 “Tape outline, carrier tape X3T-OH047”](#) ...continued

Item	Symbol	Specification	
		Dimension [mm]	Tolerance
<b>Distance between center lines</b>			
Sprocket hole / cavity center	P <sub>2</sub>	2	±0.05
Sprocket hole / cavity hole	P <sub>3</sub>	2	±0.05
Sprocket hole / cavity center	F <sub>0</sub>	3.5	±0.05
Sprocket hole / cavity hole	F <sub>2</sub>	3.5	±0.05
<b>Compartments</b>			
Length	A <sub>0</sub>	1.4	±0.05
Width overall	B <sub>0</sub>	2.7	±0.05
Depth	K <sub>0</sub>	0.5	±0.05
Hole diameter	D <sub>1</sub>	0.5	±0.1
Pitch	P <sub>1</sub>	4	±0.1
<b>Device</b>			
Outline	X3T-OH047		
Rotation	Θ	≤ 15°	-
<b>Carrier tape antistatic</b>			
Film thickness <sup>[2]</sup>	T	0.25	±0.07
Bend	δ	≤ 0.3	-
<b>Cover tape</b>			
Width	W <sub>1</sub>	5.3	±0.1
Film thickness	T <sub>1</sub>	0.05	±0.01
<b>Bending radius</b>			
In winding direction	R	≥ 30	-

[1] Cumulate pitch error ±0.2 over 10 pitch.

[2] Carbon loaded polystyrene 100 % recyclable.

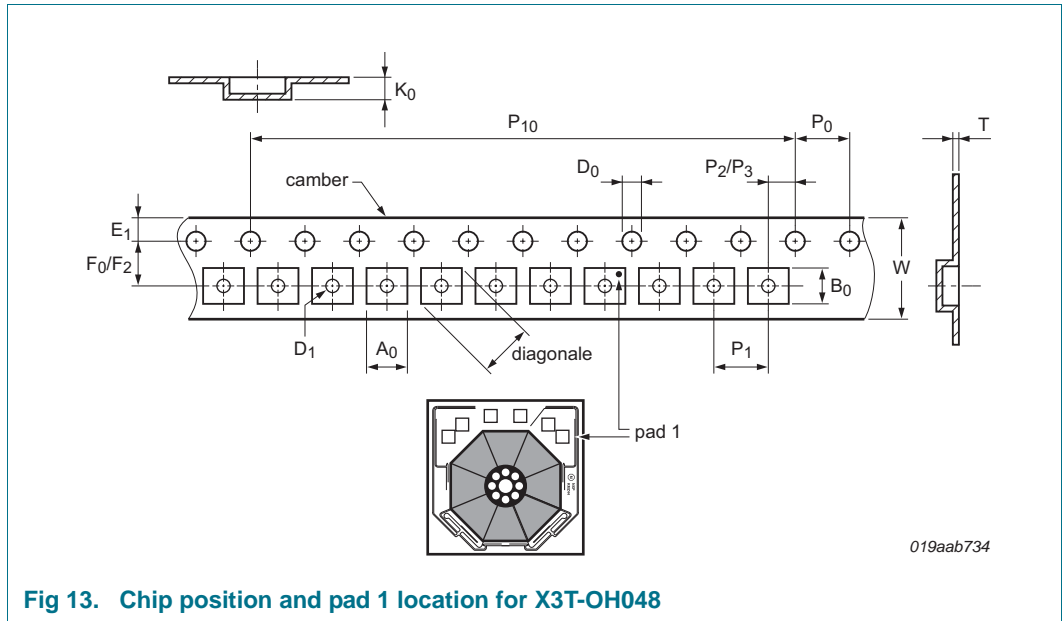

Fig 13. Chip position and pad 1 location for X3T-OH048

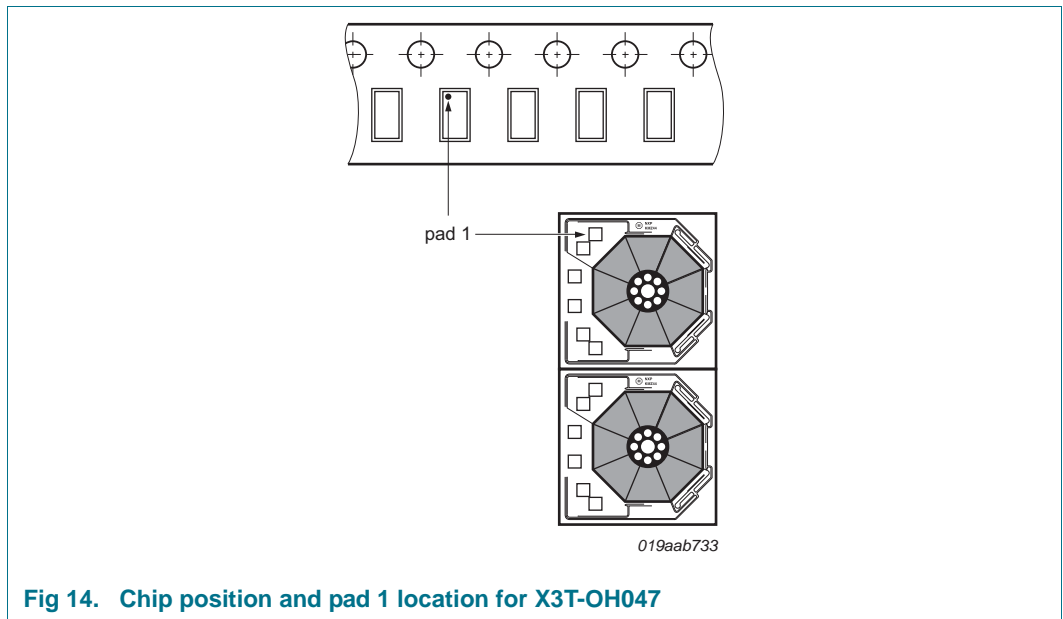

Fig 14. Chip position and pad 1 location for X3T-OH047

## 9. Revision history

Table 13. Revision history

Document ID	Release date	Data sheet status	Change notice	Supersedes
X3G_T_OH047_048 v.1	20110404	Product specification	-	-



## 10. Legal information

### 10.1 Data sheet status

Document status <sup>[1][2]</sup>	Product status <sup>[3]</sup>	Definition
Objective [short] data sheet	Development	This document contains data from the objective specification for product development.
Preliminary [short] data sheet	Qualification	This document contains data from the preliminary specification.
Product [short] data sheet	Production	This document contains the product specification.

[1] Please consult the most recently issued document before initiating or completing a design.

[2] The term 'short data sheet' is explained in section "Definitions".

[3] The product status of device(s) described in this document may have changed since this document was published and may differ in case of multiple devices. The latest product status information is available on the Internet at URL <http://www.nxp.com>.

### 10.2 Definitions

**Draft** — The document is a draft version only. The content is still under internal review and subject to formal approval, which may result in modifications or additions. NXP Semiconductors does not give any representations or warranties as to the accuracy or completeness of information included herein and shall have no liability for the consequences of use of such information.

**Short data sheet** — A short data sheet is an extract from a full data sheet with the same product type number(s) and title. A short data sheet is intended for quick reference only and should not be relied upon to contain detailed and full information. For detailed and full information see the relevant full data sheet, which is available on request via the local NXP Semiconductors sales office. In case of any inconsistency or conflict with the short data sheet, the full data sheet shall prevail.

**Product specification** — The information and data provided in a Product data sheet shall define the specification of the product as agreed between NXP Semiconductors and its customer, unless NXP Semiconductors and customer have explicitly agreed otherwise in writing. In no event however, shall an agreement be valid in which the NXP Semiconductors product is deemed to offer functions and qualities beyond those described in the Product data sheet.

### 10.3 Disclaimers

**Limited warranty and liability** — Information in this document is believed to be accurate and reliable. However, NXP Semiconductors does not give any representations or warranties, expressed or implied, as to the accuracy or completeness of such information and shall have no liability for the consequences of use of such information.

In no event shall NXP Semiconductors be liable for any indirect, incidental, punitive, special or consequential damages (including - without limitation - lost profits, lost savings, business interruption, costs related to the removal or replacement of any products or rework charges) whether or not such damages are based on tort (including negligence), warranty, breach of contract or any other legal theory.

Notwithstanding any damages that customer might incur for any reason whatsoever, NXP Semiconductors' aggregate and cumulative liability towards customer for the products described herein shall be limited in accordance with the *Terms and conditions of commercial sale* of NXP Semiconductors.

**Right to make changes** — NXP Semiconductors reserves the right to make changes to information published in this document, including without limitation specifications and product descriptions, at any time and without notice. This document supersedes and replaces all information supplied prior to the publication hereof.

**Suitability for use in automotive applications** — This NXP Semiconductors product has been qualified for use in automotive applications. The product is not designed, authorized or warranted to be

suitable for use in medical, military, aircraft, space or life support equipment, nor in applications where failure or malfunction of an NXP Semiconductors product can reasonably be expected to result in personal injury, death or severe property or environmental damage. NXP Semiconductors accepts no liability for inclusion and/or use of NXP Semiconductors products in such equipment or applications and therefore such inclusion and/or use is at the customer's own risk.

**Applications** — Applications that are described herein for any of these products are for illustrative purposes only. NXP Semiconductors makes no representation or warranty that such applications will be suitable for the specified use without further testing or modification.

Customers are responsible for the design and operation of their applications and products using NXP Semiconductors products, and NXP Semiconductors accepts no liability for any assistance with applications or customer product design. It is customer's sole responsibility to determine whether the NXP Semiconductors product is suitable and fit for the customer's applications and products planned, as well as for the planned application and use of customer's third party customer(s). Customers should provide appropriate design and operating safeguards to minimize the risks associated with their applications and products.

NXP Semiconductors does not accept any liability related to any default, damage, costs or problem which is based on any weakness or default in the customer's applications or products, or the application or use by customer's third party customer(s). Customer is responsible for doing all necessary testing for the customer's applications and products using NXP Semiconductors products in order to avoid a default of the applications and the products or of the application or use by customer's third party customer(s). NXP does not accept any liability in this respect.

**Limiting values** — Stress above one or more limiting values (as defined in the Absolute Maximum Ratings System of IEC 60134) will cause permanent damage to the device. Limiting values are stress ratings only and (proper) operation of the device at these or any other conditions above those given in the Recommended operating conditions section (if present) or the Characteristics sections of this document is not warranted. Constant or repeated exposure to limiting values will permanently and irreversibly affect the quality and reliability of the device.

**Terms and conditions of commercial sale** — NXP Semiconductors products are sold subject to the general terms and conditions of commercial sale, as published at <http://www.nxp.com/profile/terms>, unless otherwise agreed in a valid written individual agreement. In case an individual agreement is concluded only the terms and conditions of the respective agreement shall apply. NXP Semiconductors hereby expressly objects to applying the customer's general terms and conditions with regard to the purchase of NXP Semiconductors products by customer.

**No offer to sell or license** — Nothing in this document may be interpreted or construed as an offer to sell products that is open for acceptance or the grant, conveyance or implication of any license under any copyrights, patents or other industrial or intellectual property rights.

**Export control** — This document as well as the item(s) described herein may be subject to export control regulations. Export might require a prior authorization from national authorities.

**Quick reference data** — The Quick reference data is an extract of the product data given in the Limiting values and Characteristics sections of this document, and as such is not complete, exhaustive or legally binding.

## 10.4 Trademarks

Notice: All referenced brands, product names, service names and trademarks are the property of their respective owners.

## 11. Contact information

---

For more information, please visit: <http://www.nxp.com>

For sales office addresses, please send an email to: [salesaddresses@nxp.com](mailto:salesaddresses@nxp.com)

## 12. Contents

---

<b>1</b>	<b>Product profile</b> . . . . .	<b>1</b>
1.1	General description . . . . .	1
1.2	Features and benefits . . . . .	2
1.3	Applications . . . . .	2
1.4	Quick reference data . . . . .	3
<b>2</b>	<b>Pinning information</b> . . . . .	<b>3</b>
<b>3</b>	<b>Ordering information</b> . . . . .	<b>4</b>
<b>4</b>	<b>Circuit diagram</b> . . . . .	<b>4</b>
<b>5</b>	<b>Limiting values</b> . . . . .	<b>4</b>
<b>6</b>	<b>Characteristics</b> . . . . .	<b>5</b>
<b>7</b>	<b>Bare die outline</b> . . . . .	<b>7</b>
<b>8</b>	<b>Packing information</b> . . . . .	<b>9</b>
8.1	Tape construction for X3G-OH047 and X3G-OH048 . . . . .	9
8.2	Carrier tape for X3T-OH047 and X3T-OH048 .	13
<b>9</b>	<b>Revision history</b> . . . . .	<b>16</b>
<b>10</b>	<b>Legal information</b> . . . . .	<b>17</b>
10.1	Data sheet status . . . . .	17
10.2	Definitions . . . . .	17
10.3	Disclaimers . . . . .	17
10.4	Trademarks . . . . .	18
<b>11</b>	<b>Contact information</b> . . . . .	<b>18</b>
<b>12</b>	<b>Contents</b> . . . . .	<b>19</b>

---

Please be aware that important notices concerning this document and the product(s) described herein, have been included in section 'Legal information'.

---

© NXP B.V. 2011.

All rights reserved.

For more information, please visit: <http://www.nxp.com>

For sales office addresses, please send an email to: [salesaddresses@nxp.com](mailto:salesaddresses@nxp.com)

Date of release: 4 April 2011

Document identifier: X3G\_T\_OH047\_048