

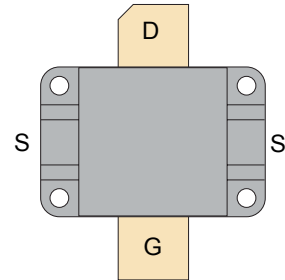

## RF POWER VERTICAL MOSFET

The VRF157FL is a gold-metallized silicon n-channel RF power transistor designed for broadband commercial and military applications requiring high power and gain without compromising reliability, ruggedness, or inter-modulation distortion.



### FEATURES

- Improved Ruggedness  $V_{(BR)DSS} = 170V$
- Designed for 2-100MHz Operation
- 600W with 21dB Typical Gain @ 30MHz, 50V
- Excellent Stability & Low IMD
- Common Source Configuration
- Available in Matched Pairs
- 70:1 Load VSWR Capability at Specified Operating Conditions
- Nitride Passivated
- Economical Flangeless Package
- Refractory Gold Metallization
- High Voltage Replacement for MRF157
- RoHS Compliant 

### Maximum Ratings

All Ratings:  $T_c = 25^\circ C$  unless otherwise specified

Symbol	Parameter	VRF157FL(MP)	Unit
$V_{DSS}$	Drain-Source Voltage	170	V
$I_D$	Continuous Drain Current @ $T_c = 25^\circ C$	60	A
$V_{GS}$	Gate-Source Voltage	$\pm 40$	V
$P_D$	Total Device dissipation @ $T_c = 25^\circ C$	1350	W
$T_{STG}$	Storage Temperature Range	-65 to 150	$^\circ C$
$T_J$	Operating Junction Temperature Max	200	

### Static Electrical Characteristics

Symbol	Parameter	Min	Typ	Max	Unit
$V_{(BR)DSS}$	Drain-Source Breakdown Voltage ( $V_{GS} = 0V, I_D = 100mA$ )	170	180		V
$V_{DS(ON)}$	On State Drain Voltage ( $I_{D(ON)} = 40A, V_{GS} = 10V$ )		3.0	5.0	
$I_{DSS}$	Zero Gate Voltage Drain Current ( $V_{DS} = 100V, V_{GS} = 0V$ )			4.0	mA
$I_{GSS}$	Gate-Source Leakage Current ( $V_{DS} = \pm 20V, V_{GS} = 0V$ )			4.0	$\mu A$
$g_{fs}$	Forward Transconductance ( $V_{DS} = 10V, I_D = 20A$ )	16			mhos
$V_{GS(TH)}$	Gate Threshold Voltage ( $V_{DS} = 10V, I_D = 100mA$ )	2.9	3.6	4.4	V

### Thermal Characteristics

Symbol	Characteristic	Min	Typ	Max	Unit
$R_{\theta JC}$	Junction to Case Thermal Resistance			0.13	$^\circ C/W$
$R_{\theta JHS}$	Junction to Sink Thermal Resistance (Use High Efficiency Thermal Joint Compound and Planar Heat Sink Surface.)		0.22		



**CAUTION:** These Devices are Sensitive to Electrostatic Discharge. Proper Handling Procedures Should Be Followed.

## Dynamic Characteristics

VRF157FL(MP)

Symbol	Parameter	Test Conditions	Min	Typ	Max	Unit
$C_{ISS}$	Input Capacitance	$V_{GS} = 0V$		1580		pF
$C_{OSS}$	Output Capacitance	$V_{DS} = 50V$		810		
$C_{RSS}$	Reverse Transfer Capacitance	$f = 1MHz$		65		

## Functional Characteristics

Symbol	Parameter	Min	Typ	Max	Unit
$G_{PS}$	$f = 30MHz, V_{DD} = 50V, I_{DQ} = 800mA, P_{out} = 600W$	17	21		dB
$\eta_D$	$f = 30MHz, V_{DD} = 50V, I_{DQ} = 800mA, P_{out} = 600W_{PEP}$		45		%
$IMD_{(dB)}$	$f1 = 30MHz, f2 = 30.001MHz, V_{DD} = 50V, I_{DQ} = 800mA, P_{out} = 600W_{PEP}^1$		-25		dBc
$\psi$	$f = 30MHz, V_{DD} = 50V, I_{DQ} = 800mA, P_{out} = 600W_{CW}$ 70:1 VSWR - All Phase Angles, 0.2mSec X 20% Duty Factor	No Degradation in Output Power			

1. To MIL-STD-1311 Version A, test method 2204B, Two Tone, Reference Each Tone

Microsemi reserves the right to change, without notice, the specifications and information contained herein.

## Typical Performance Curves

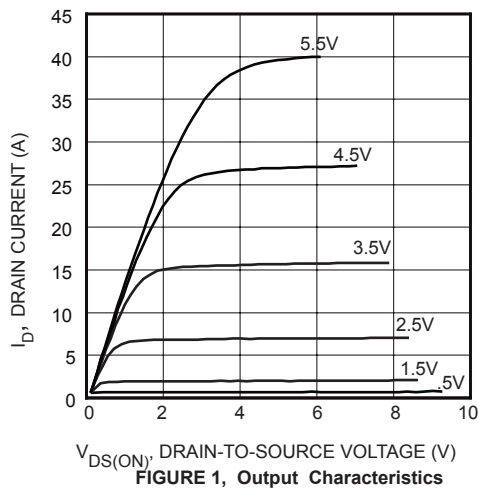

FIGURE 1, Output Characteristics

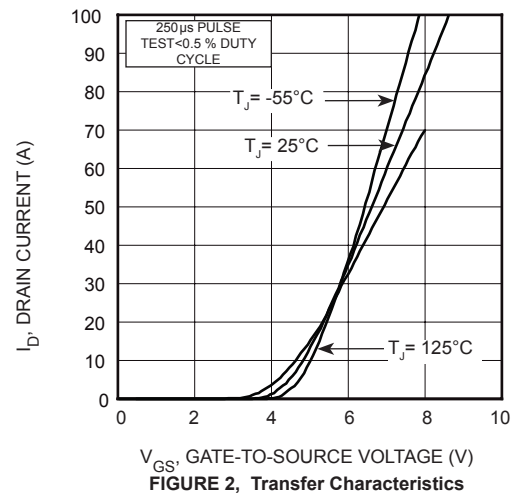

FIGURE 2, Transfer Characteristics

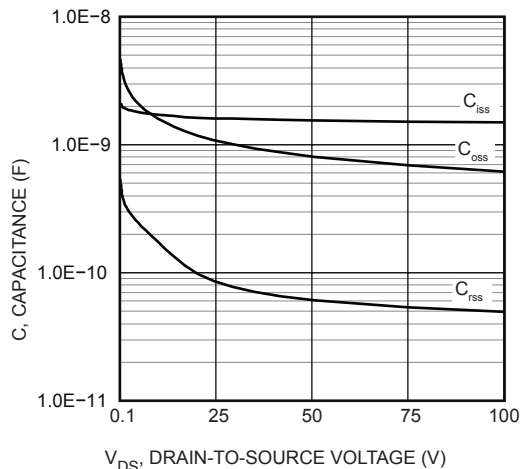

FIGURE 3, Capacitance vs Drain-to-Source Voltage

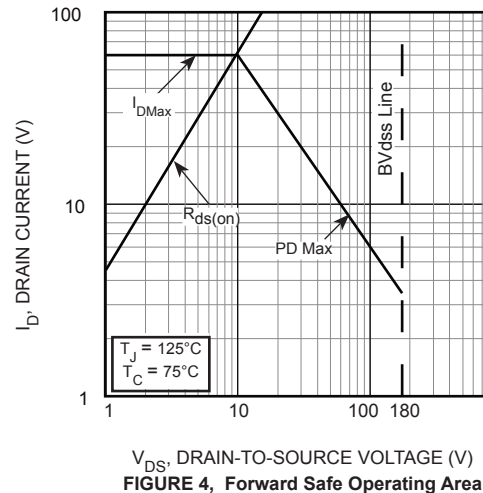

FIGURE 4, Forward Safe Operating Area

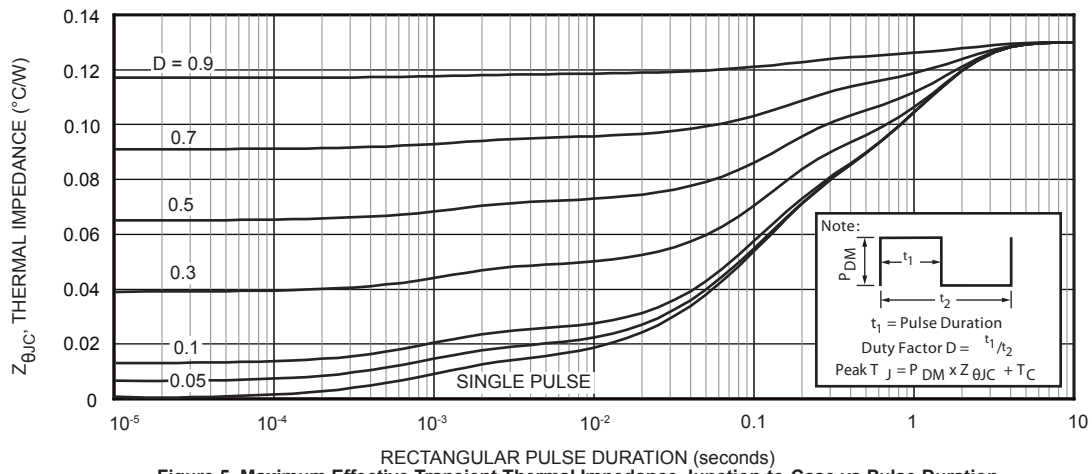

Figure 5. Maximum Effective Transient Thermal Impedance Junction-to-Case vs Pulse Duration

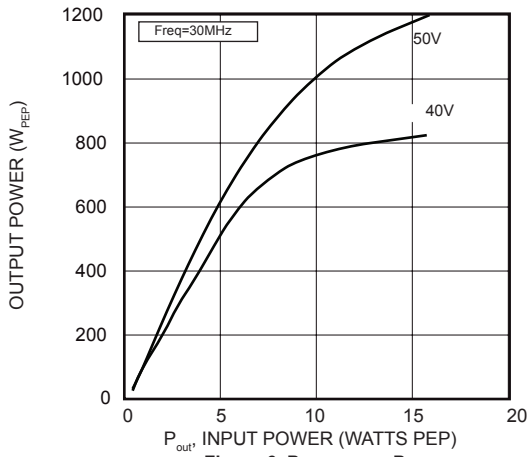

Figure 6.  $P_{OUT}$  versus  $P_{IN}$

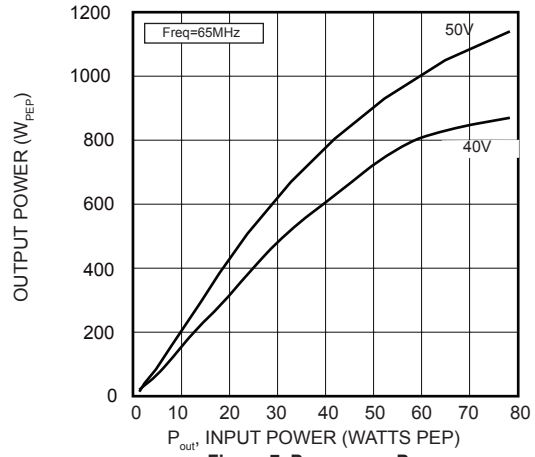

Figure 7.  $P_{OUT}$  versus  $P_{IN}$



Adding MP at the end of P/N specifies a matched pair where  $V_{GS(TH)}$  is matched between the two parts.  $V_{TH}$  values are marked on the devices per the following table.

Code	Vth Range	Code 2	Vth Range
A	2.900 - 2.975	M	3.650 - 3.725
B	2.975 - 3.050	N	3.725 - 3.800
C	3.050 - 3.125	P	3.800 - 3.875
D	3.125 - 3.200	R	3.875 - 3.950
E	3.200 - 3.275	S	3.950 - 4.025
F	3.275 - 3.350	T	4.025 - 4.100
G	3.350 - 3.425	W	4.100 - 4.175
H	3.425 - 3.500	X	4.175 - 4.250
J	3.500 - 3.575	Y	4.250 - 4.325
K	3.575 - 3.650	Z	4.325 - 4.400

$V_{TH}$  values are based on Microsemi measurements at datasheet conditions with an accuracy of 1.0%.

**Thermal Considerations and Package Mounting:**

The rated 1350W power dissipation is only available when the package mounting surface is at 25°C and the junction temperature is 200°C. The thermal resistance between junctions and case mounting surface is 0.13°C/W. When installed, an additional thermal impedance of 0.09°C/W between the package base and the mounting surface is smooth and flat. Thermal joint compound must be used to reduce the effects of small surface irregularities. The heatsink should incorporate a copper heat spreader to obtain best results.

The lid maintains the required mounting pressure while allowing for thermal expansion of both the device and the heat sink. Four 4-40 (M3) screws provide the minimum 125 lb. required mounting force. T=4-6 in-lb. Please refer to App Note 1810 "Mounting Instructions for Flangeless Packages."

**HAZARDOUS MATERIAL WARNING**

The ceramic portion of the device between leads and mounting flange is beryllium oxide. Beryllium oxide dust is highly toxic when inhaled. Care must be taken during handling and mounting to avoid damage to this area. These devices must never be thrown away with general industrial or domestic waste. BeO substrate weight: 1.934g. Percentage of total module weight which is BeO: 20%.

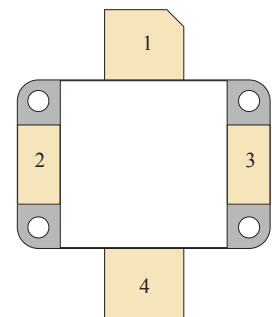
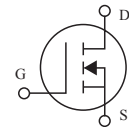
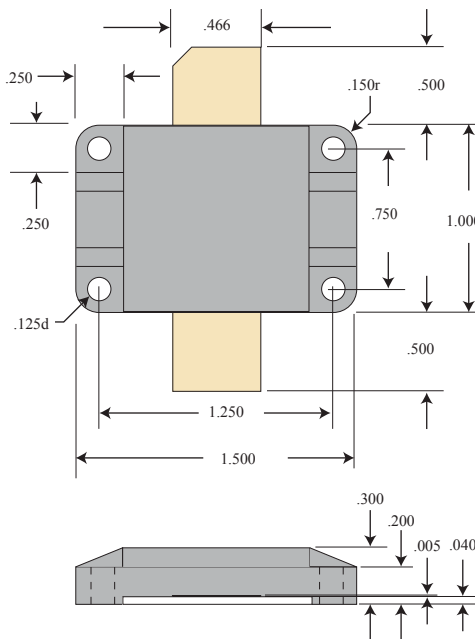

PIN 1 - DRAIN  
 PIN 2 - SOURCE  
 PIN 3 - SOURCE  
 PIN 4 - GATE

**Disclaimer:**

The information contained in the document (unless it is publicly available on the Web without access restrictions) is PROPRIETARY AND CONFIDENTIAL information of Microsemi and cannot be copied, published, uploaded, posted, transmitted, distributed or disclosed or used without the express duly signed written consent of Microsemi. If the recipient of this document has entered into a disclosure agreement with Microsemi, then the terms of such Agreement will also apply. This document and the information contained herein may not be modified, by any person other than authorized personnel of Microsemi. No license under any patent, copyright, trade secret or other intellectual property right is granted to or conferred upon you by disclosure or delivery of the information, either expressly, by implication, inducement, estoppels or otherwise. Any license under such intellectual property rights must be approved by Microsemi in writing signed by an officer of Microsemi.

Microsemi reserves the right to change the configuration, functionality and performance of its products at anytime without any notice. This product has been subject to limited testing and should not be used in conjunction with life-support or other mission-critical equipment or applications. Microsemi assumes no liability whatsoever, and Microsemi disclaims any express or implied warranty, relating to sale and/or use of Microsemi products including liability or warranties relating to fitness for a particular purpose, merchantability, or infringement of any patent, copyright or other intellectual property right. Any performance specifications believed to be reliable but are not verified and customer or user must conduct and complete all performance and other testing of this product as well as any user or customers final application. User or customer shall not rely on any data and performance specifications or parameters provided by Microsemi. It is the customer's and user's responsibility to independently determine suitability of any Microsemi product and to test and verify the same. The information contained herein is provided "AS IS, WHERE IS" and with all faults, and the entire risk associated with such information is entirely with the User. Microsemi specifically disclaims any liability of any kind including for consequential, incidental and punitive damages as well as lost profit. The product is subject to other terms and conditions which can be located on the web at <http://www.microsemi.com/legal/tnc.asp>