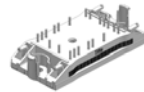
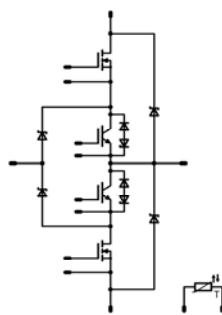

flowNPC 0	600V/30A
<div style="border: 1px solid black; padding: 5px; margin-bottom: 10px;"> <p style="text-align: center; background-color: #000080; color: white; margin: 0;">Features</p> <ul style="list-style-type: none"> neutral point clamped inverter reactive power capability clip-in pcb mounting low inductance layout </div> <div style="border: 1px solid black; padding: 5px; margin-bottom: 10px;"> <p style="text-align: center; background-color: #000080; color: white; margin: 0;">Target Applications</p> <ul style="list-style-type: none"> solar inverter UPS </div> <div style="border: 1px solid black; padding: 5px;"> <p style="text-align: center; background-color: #000080; color: white; margin: 0;">Types</p> <ul style="list-style-type: none"> FZ06NRA045FH01 </div>	<div style="border: 1px solid black; padding: 5px; margin-bottom: 10px;"> <p style="text-align: center; background-color: #000080; color: white; margin: 0;">flow0 12mm housing</p>  </div> <div style="border: 1px solid black; padding: 5px;"> <p style="text-align: center; background-color: #000080; color: white; margin: 0;">Schematic</p>  </div>

Maximum Ratings

$T_j=25^\circ\text{C}$, unless otherwise specified

Parameter	Symbol	Condition	Value	Unit
Buck Diode				
Peak Repetitive Reverse Voltage	V_{RRM}	$T_j=25^\circ\text{C}$	600	V
DC forward current	I_F	$T_j=T_{jmax}$	25 34	A
Repetitive peak forward current	I_{FRM}	t_p limited by T_{jmax}	120	A
Power dissipation per Diode	P_{tot}	$T_j=T_{jmax}$	36 54	W
Maximum Junction Temperature	T_{jmax}		150	$^\circ\text{C}$
Buck MOSFET				
Drain to source breakdown voltage	V_{DS}		600	V
DC drain current	I_D	$T_j=T_{jmax}$	36 44	A
Pulsed drain current	I_{Dpulse}	t_p limited by T_{jmax}	230	A
Power dissipation	P_{tot}	$T_j=T_{jmax}$	125 189	W
Gate-source peak voltage	V_{gs}		± 20	V
Maximum Junction Temperature	T_{jmax}		150	$^\circ\text{C}$

Maximum Ratings

 $T_j=25^{\circ}\text{C}$, unless otherwise specified

Parameter	Symbol	Condition	Value	Unit
Boost IGBT				
Collector-emitter break down voltage	V_{CE}		600	V
DC collector current	I_C	$T_j=T_{j,max}$ $T_h=80^{\circ}\text{C}$ $T_c=80^{\circ}\text{C}$	47 50	A
Repetitive peak collector current	$I_{C,puls}$	t_p limited by $T_{j,max}$	225	A
Power dissipation per IGBT	P_{tot}	$T_j=T_{j,max}$ $T_h=80^{\circ}\text{C}$ $T_c=80^{\circ}\text{C}$	85 129	W
Gate-emitter peak voltage	V_{GE}		± 20	V
Short circuit ratings	t_{SC}	$T_j \leq 150^{\circ}\text{C}$	6	μs
	V_{CC}	$V_{GE}=15\text{V}$	360	V
Maximum Junction Temperature	$T_{j,max}$		175	$^{\circ}\text{C}$

Boost Inverse Diode

Peak Repetitive Reverse Voltage	V_{RRM}	$T_c=25^{\circ}\text{C}$	600	V
DC forward current	I_F	$T_j=T_{j,max}$ $T_h=80^{\circ}\text{C}$ $T_c=80^{\circ}\text{C}$	2	A
Boost Inverse Diode	P_{tot}	$T_j=T_{j,max}$ $T_h=80^{\circ}\text{C}$ $T_c=80^{\circ}\text{C}$	21	W
Maximum Junction Temperature	$T_{j,max}$		150	$^{\circ}\text{C}$

Boost Diode

Peak Repetitive Reverse Voltage	V_{RRM}	$T_j=25^{\circ}\text{C}$	1200	V
DC forward current	I_F	$T_j=T_{j,max}$ $T_h=80^{\circ}\text{C}$ $T_c=80^{\circ}\text{C}$	16 21	A
Repetitive peak forward current	I_{FRM}	t_p limited by $T_{j,max}$	36	A
Power dissipation per Diode	P_{tot}	$T_j=T_{j,max}$ $T_h=80^{\circ}\text{C}$ $T_c=80^{\circ}\text{C}$	30 46	W
Maximum Junction Temperature	$T_{j,max}$		150	$^{\circ}\text{C}$

Thermal Properties

Storage temperature	T_{stg}		$-40 \dots +125$	$^{\circ}\text{C}$
Operation temperature under switching condition	T_{op}		$-40 \dots +(T_{j,max} - 25)$	$^{\circ}\text{C}$

Insulation Properties

Insulation voltage	V_{is}	$t=2\text{s}$ DC voltage	4000	V
Creepage distance			min 12,7	mm
Clearance			min 12,7	mm

Characteristic Values

Parameter	Symbol	Conditions					Value			Unit
		$V_{GE}[V]$ or $V_{GS}[V]$	$V_r[V]$ or $V_{CE}[V]$ or $V_{DS}[V]$	$I_c[A]$ or $I_F[A]$ or $I_D[A]$	T_j	Min	Typ	Max		
Buck Diode										
Diode forward voltage	V_F				30	$T_j=25^\circ C$ $T_j=125^\circ C$	1	2,25 1,66	2,7	V
Peak reverse recovery current	I_{RRM}					$T_j=25^\circ C$ $T_j=125^\circ C$		57 82		A
Reverse recovery time	t_{rr}					$T_j=25^\circ C$ $T_j=125^\circ C$		14 22		ns
Reverse recovered charge	Q_{rr}	Rgon=8 Ω		350	30	$T_j=25^\circ C$ $T_j=125^\circ C$		0,43 0,99		μC
Peak rate of fall of recovery current	$di(rec)max/dt$					$T_j=25^\circ C$ $T_j=125^\circ C$		16743 15517		A/μs
Reverse recovered energy	Erec					$T_j=25^\circ C$ $T_j=125^\circ C$		0,070 0,137		mWs
Thermal resistance chip to heatsink per chip	R_{thJH}	Thermal grease thickness≤50um $\lambda = 1$ W/mK						1,95		K/W
Buck MOSFET										
Static drain to source ON resistance	$R_{ds(on)}$		10		44	$T_j=25^\circ C$ $T_j=125^\circ C$		42 83		mΩ
Gate threshold voltage	$V_{(GS)th}$		VDS=VGS	$V_{DS}=V_{GS}$	0,003	$T_j=25^\circ C$ $T_j=125^\circ C$	2,1	3	3,9	V
Gate to Source Leakage Current	I_{gss}		20	0		$T_j=25^\circ C$ $T_j=125^\circ C$			200	nA
Zero Gate Voltage Drain Current	I_{dss}		0	600		$T_j=25^\circ C$ $T_j=125^\circ C$			25	μA
Turn On Delay Time	$t_{d(ON)}$					$T_j=25^\circ C$ $T_j=125^\circ C$		30 31		ns
Rise Time	t_r					$T_j=25^\circ C$ $T_j=125^\circ C$		8 8		
Turn off delay time	$t_{d(OFF)}$	Rgon=8 Ω Rgoff=8 Ω	15	350	30	$T_j=25^\circ C$ $T_j=125^\circ C$		269 295		
Fall time	t_f					$T_j=25^\circ C$ $T_j=125^\circ C$		7 140		
Turn-on energy loss per pulse	E_{on}					$T_j=25^\circ C$ $T_j=125^\circ C$		0,161 0,265		mWs
Turn-off energy loss per pulse	E_{off}					$T_j=25^\circ C$ $T_j=125^\circ C$		0,085 0,104		
Total gate charge	Q_g							150	190	nC
Gate to source charge	Q_{gs}		15	350	30	$T_j=25^\circ C$		34		
Gate to drain charge	Q_{gd}							51		
Input capacitance	C_{iss}	f=1MHz	0	100		$T_j=25^\circ C$		6800		pF
Output capacitance	C_{oss}							320		
Thermal resistance chip to heatsink per chip	R_{thJH}	Thermal grease thickness≤50um $\lambda = 1$ W/mK						0,56		K/W

Characteristic Values

Parameter	Symbol	Conditions					Value			Unit
		$V_{GE}[V]$ or $V_{GS}[V]$	$V_r[V]$ or $V_{CE}[V]$ or $V_{DS}[V]$	$I_c[A]$ or $I_F[A]$ or $I_b[A]$	T_j	Min	Typ	Max		
Boost IGBT										
Gate emitter threshold voltage	$V_{GE(th)}$	$V_{CE}=V_{GE}$			0,0012	$T_j=25^{\circ}C$ $T_j=125^{\circ}C$	5	5,8	6,5	V
Collector-emitter saturation voltage	$V_{CE(sat)}$		15		30	$T_j=25^{\circ}C$ $T_j=125^{\circ}C$	1	1,14 1,19	1,8	V
Collector-emitter cut-off incl diode	I_{CES}		0	600		$T_j=25^{\circ}C$ $T_j=125^{\circ}C$			30	μA
Gate-emitter leakage current	I_{GES}		20	0		$T_j=25^{\circ}C$ $T_j=125^{\circ}C$			650	nA
Integrated Gate resistor	R_{gint}							none		Ω
Turn-on delay time	$t_{d(on)}$	$R_{gon}=8 \Omega$ $R_{goff}=8 \Omega$	15	350	30	$T_j=25^{\circ}C$ $T_j=125^{\circ}C$	40			ns
Rise time	t_r					$T_j=25^{\circ}C$ $T_j=125^{\circ}C$	10			
Turn-off delay time	$t_{d(off)}$					$T_j=25^{\circ}C$ $T_j=125^{\circ}C$	454			
Fall time	t_f					$T_j=25^{\circ}C$ $T_j=125^{\circ}C$	502			
Turn-on energy loss per pulse	E_{on}					$T_j=25^{\circ}C$ $T_j=125^{\circ}C$	64			
Turn-off energy loss per pulse	E_{off}					$T_j=25^{\circ}C$ $T_j=125^{\circ}C$	87			
Input capacitance	C_{ies}							4620		pF
Output capacitance	C_{oss}	$f=1MHz$	0	25		$T_j=25^{\circ}C$		288		
Reverse transfer capacitance	C_{rss}							137		
Gate charge	Q_{Gate}		15	480	75	$T_j=25^{\circ}C$		470		nC
Thermal resistance chip to heatsink per chip	R_{thJH}	Thermal grease thickness $\leq 50\mu m$ $\lambda = 1 W/mK$						1,11		K/W
Boost Inverse Diode										
Diode forward voltage	V_F				20	$T_j=25^{\circ}C$ $T_j=125^{\circ}C$		9,07 9,43		V
Thermal resistance chip to heatsink per chip	R_{thJH}	Thermal grease thickness $\leq 50\mu m$ $\lambda = 1 W/mK$								K/W
Boost Diode										
Diode forward voltage	V_F				18	$T_j=25^{\circ}C$ $T_j=125^{\circ}C$	1,5	3,14 2,71	3,5	V
Reverse leakage current	I_r			1200		$T_j=25^{\circ}C$ $T_j=125^{\circ}C$			100	μA
Peak reverse recovery current	I_{RRM}	$R_{gon}=8 \Omega$	350	30		$T_j=25^{\circ}C$ $T_j=125^{\circ}C$	92			A
Reverse recovery time	t_{rr}					$T_j=25^{\circ}C$ $T_j=125^{\circ}C$	37			
Reverse recovered charge	Q_{rr}					$T_j=25^{\circ}C$ $T_j=125^{\circ}C$	52			
Peak rate of fall of recovery current	$di(rec)max/dt$					$T_j=25^{\circ}C$ $T_j=125^{\circ}C$	2,8			
Reverse recovery energy	E_{rec}					$T_j=25^{\circ}C$ $T_j=125^{\circ}C$	5,7			
Thermal resistance chip to heatsink per chip	R_{thJH}					Thermal grease thickness $\leq 50\mu m$ $\lambda = 1 W/mK$				
Thermistor										
Rated resistance*	R_{25}	Tol. $\pm 13\%$				$T_j=25^{\circ}C$	19,14	22	24,86	k Ω
	R_{100}	Tol. $\pm 5\%$				$T_j=100^{\circ}C$	1411	1486	1560	Ω
Power dissipation	P					$T_j=25^{\circ}C$		210		mW
B-value	$B_{(25/100)}$	Tol. $\pm 3\%$				$T_j=25^{\circ}C$		4000		K

* see details on Thermistor charts on Figure 2.

Buck

Figure 1 MOSFET

Typical output characteristics

$$I_C = f(V_{CE})$$

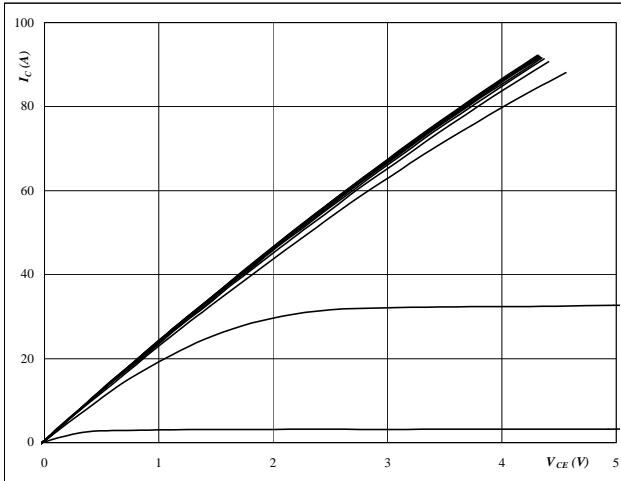

At
 $t_p = 250 \mu s$
 $T_j = 25 \text{ } ^\circ C$
 V_{GE} from 4 V to 14 V i Condition

Figure 2 MOSFET

Typical output characteristics

$$I_C = f(V_{CE})$$

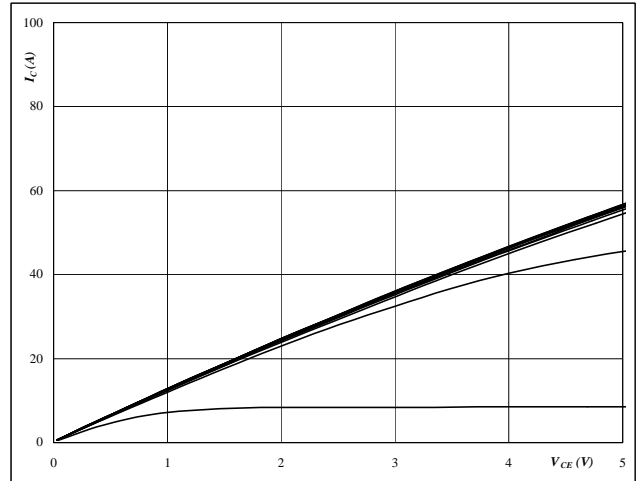

At
 $t_p = 250 \mu s$
 $T_j = 125 \text{ } ^\circ C$
 V_{GE} from 4 V to 14 V in steps of 1 V

Figure 3 MOSFET

Typical transfer characteristics

$$I_C = f(V_{GE})$$

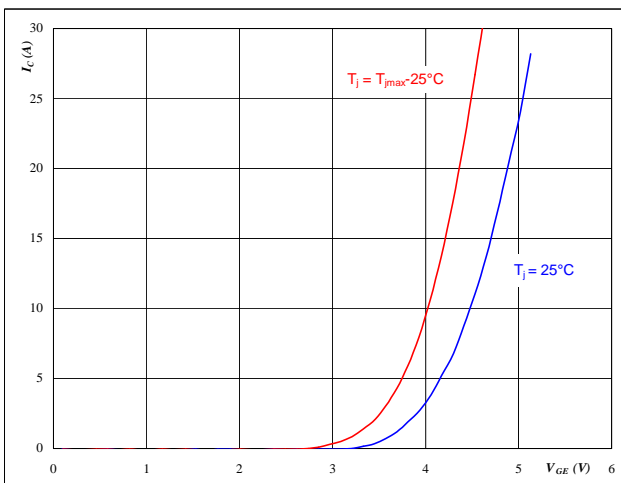

At
 $t_p = 250 \mu s$
 $V_{CE} = 10 V$

Figure 4 FRED

Typical diode forward current as a function of forward voltage

$$I_F = f(V_F)$$

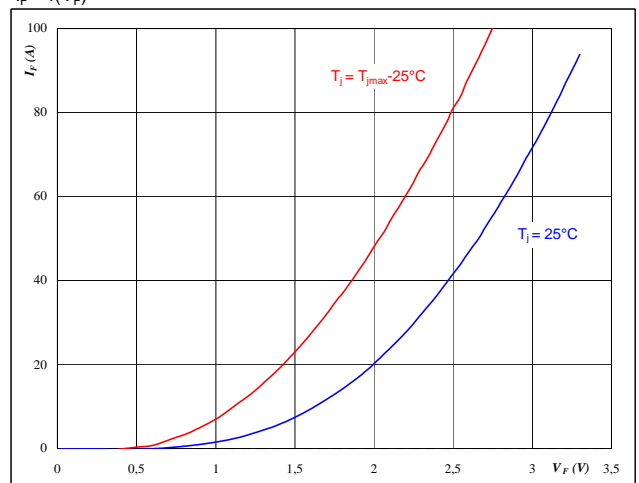

At
 $t_p = 250 \mu s$

Buck

Figure 5 MOSFET

Typical switching energy losses
as a function of collector current

$$E = f(I_C)$$

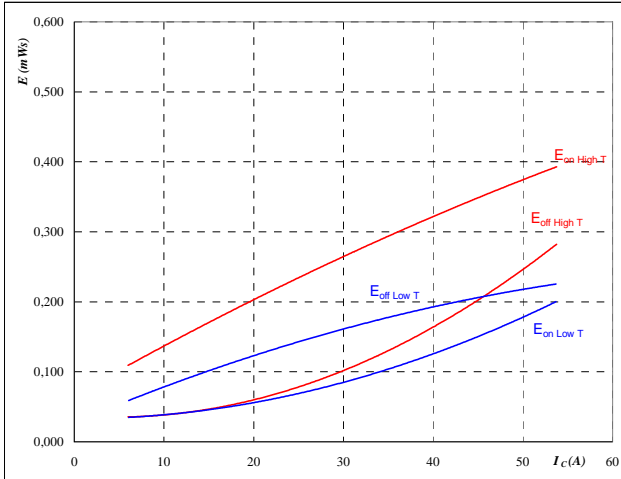

With an inductive load at

$T_J =$	25/125	°C
$V_{CE} =$	350	V
$V_{GE} =$	15	V
$R_{gon} =$	8	Ω
$R_{goff} =$	8	Ω

Figure 6 MOSFET

Typical switching energy losses
as a function of gate resistor

$$E = f(R_G)$$

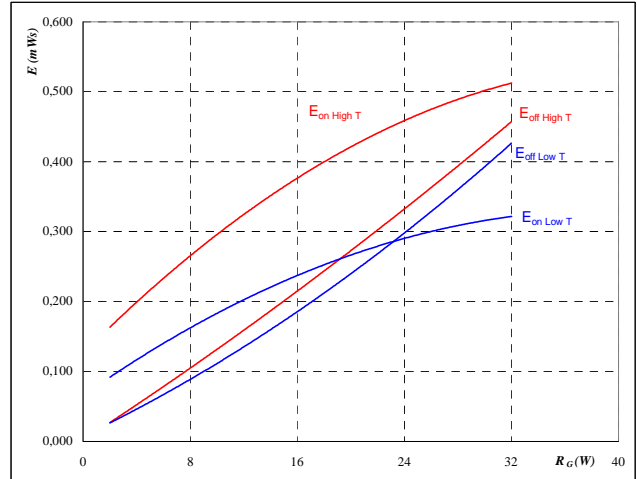

With an inductive load at

$T_J =$	25/125	°C
$V_{CE} =$	350	V
$V_{GE} =$	15	V
$I_C =$	30	A

Figure 7 FRED

Typical reverse recovery energy loss
as a function of collector current

$$E_{rec} = f(I_C)$$

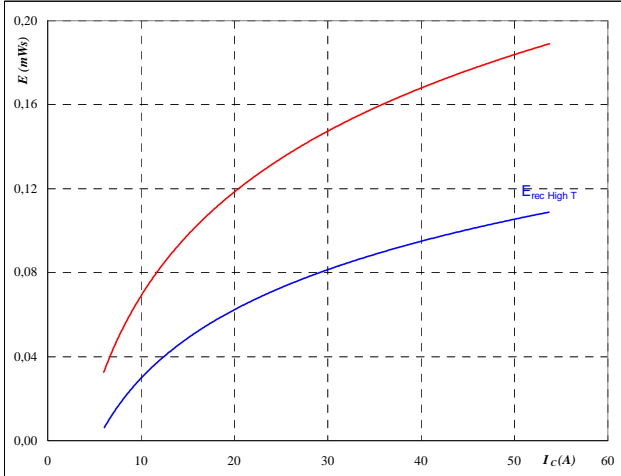

With an inductive load at

$T_J =$	25/125	°C
$V_{CE} =$	350	V
$V_{GE} =$	15	V
$R_{gon} =$	8	Ω

Figure 8 FRED

Typical reverse recovery energy loss
as a function of gate resistor

$$E_{rec} = f(R_G)$$

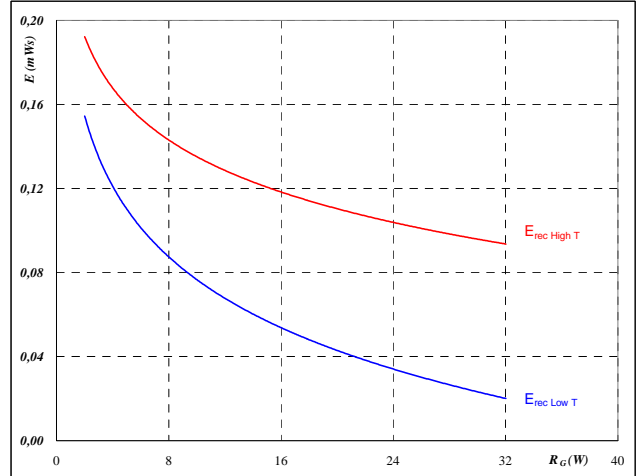

With an inductive load at

$T_J =$	25/125	°C
$V_{CE} =$	350	V
$V_{GE} =$	15	V
$I_C =$	30	A

Buck

Figure 9 MOSFET

Typical switching times as a function of collector current

$$t = f(I_C)$$

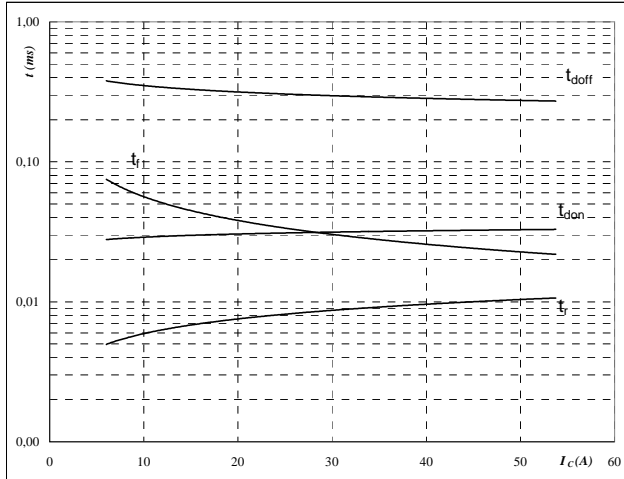

With an inductive load at

$T_J =$	125	°C
$V_{CE} =$	350	V
$V_{GE} =$	15	V
$R_{gon} =$	8	Ω
$R_{goff} =$	8	Ω

Figure 10 MOSFET

Typical switching times as a function of gate resistor

$$t = f(R_G)$$

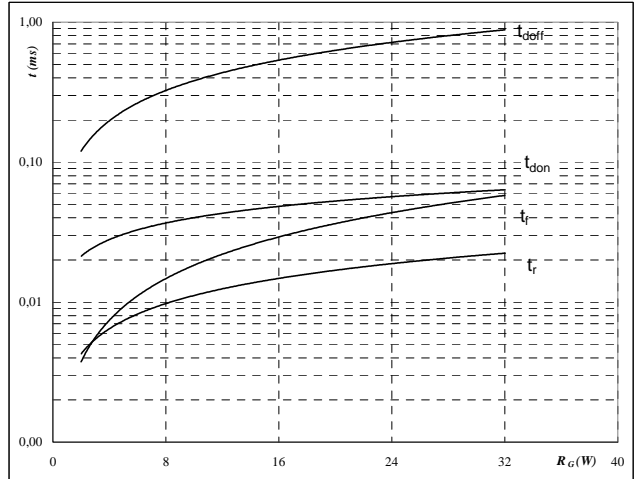

With an inductive load at

$T_J =$	125	°C
$V_{CE} =$	350	V
$V_{GE} =$	15	V
$I_C =$	30	A

Figure 11 FRED

Typical reverse recovery time as a function of collector current

$$t_{rr} = f(I_C)$$

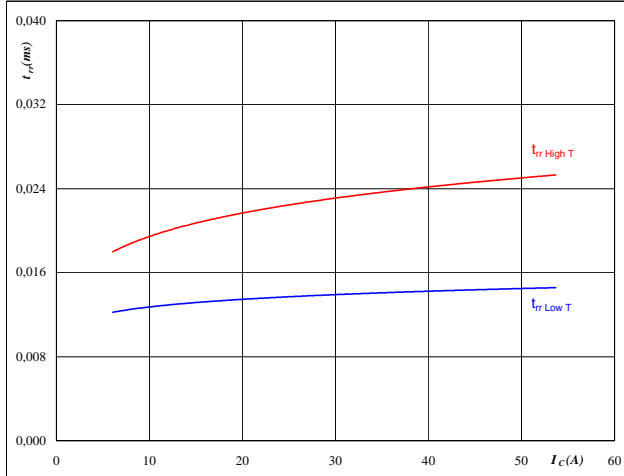

At

$T_J =$	25/125	°C
$V_{CE} =$	350	V
$V_{GE} =$	15	V
$R_{gon} =$	8	Ω

Figure 12 FRED

Typical reverse recovery time as a function of IGBT turn on gate resistor

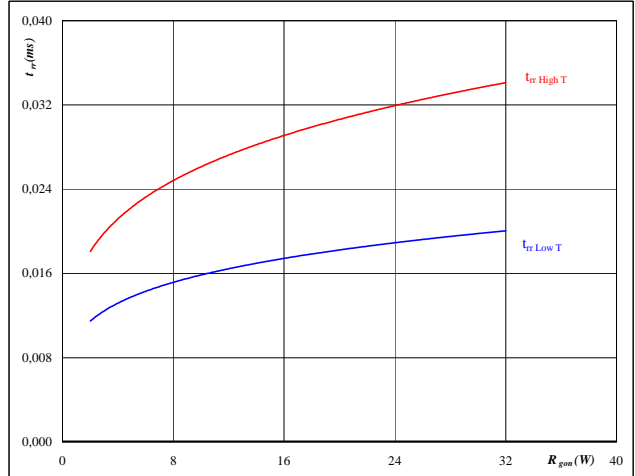
$$t_{rr} = f(R_{gon})$$

At

$T_J =$	25/125	°C
$V_R =$	350	V
$I_F =$	30	A
$V_{GE} =$	15	V

Buck

Figure 13 FRED

Typical reverse recovery charge as a function of collector current

$$Q_{rr} = f(I_c)$$

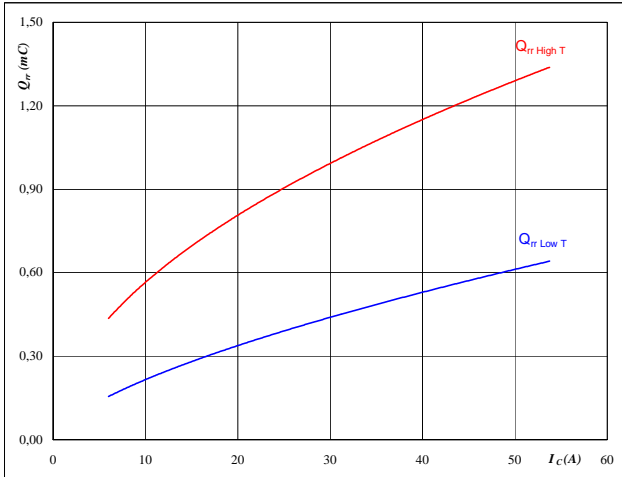

At
 $T_j = 25/125$ °C
 $V_{CE} = 350$ V
 $V_{GE} = 15$ V
 $R_{gon} = 8$ Ω

Figure 14 FRED

Typical reverse recovery charge as a function of IGBT turn on gate resistor

$$Q_{rr} = f(R_{gon})$$

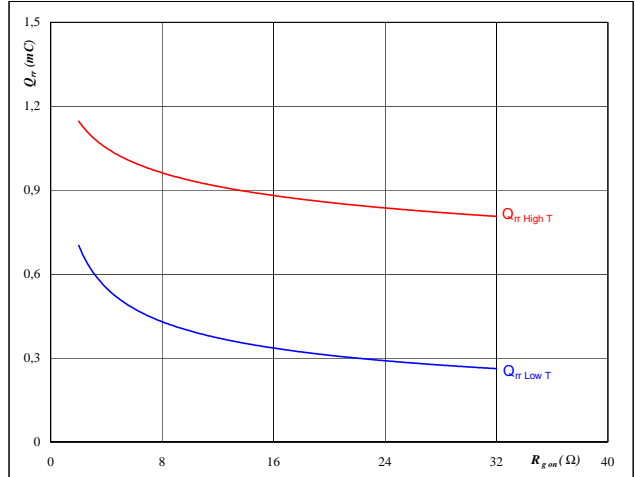

At
 $T_j = 25/125$ °C
 $V_R = 350$ V
 $I_F = 30$ A
 $V_{GE} = 15$ V

Figure 15 FRED

Typical reverse recovery current as a function of collector current

$$I_{RRM} = f(I_c)$$

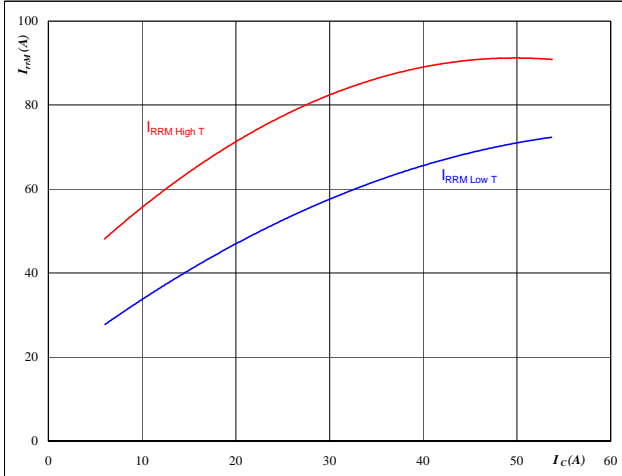

At
 $T_j = 25/125$ °C
 $V_{CE} = 350$ V
 $V_{GE} = 15$ V
 $R_{gon} = 8$ Ω

Figure 16 FRED

Typical reverse recovery current as a function of IGBT turn on gate resistor

$$I_{RRM} = f(R_{gon})$$

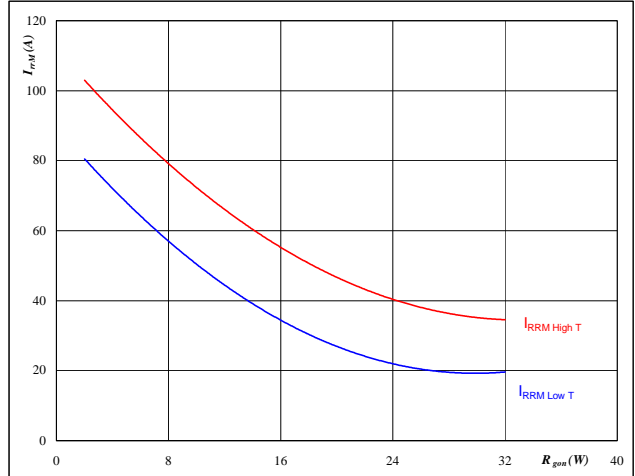

At
 $T_j = 25/125$ °C
 $V_R = 350$ V
 $I_F = 30$ A
 $V_{GE} = 15$ V

Buck

Figure 17 FRED

Typical rate of fall of forward and reverse recovery current as a function of collector current

$$di_f/dt, di_{rec}/dt = f(I_c)$$

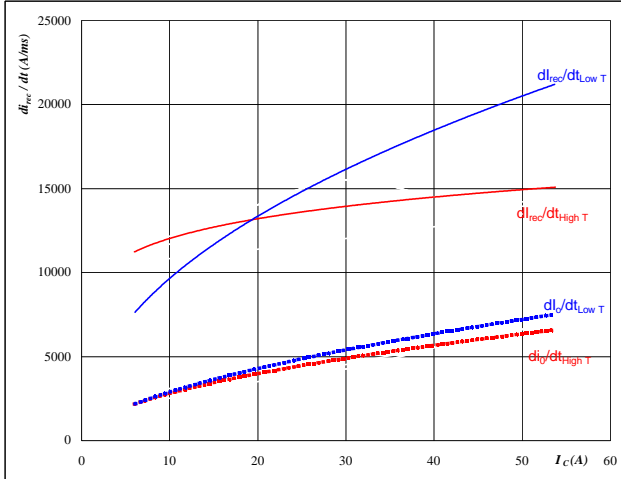

At

$T_j =$	25/125	°C
$V_{CE} =$	350	V
$V_{GE} =$	15	V
$R_{gon} =$	8	Ω

Figure 18 FRED

Typical rate of fall of forward and reverse recovery current as a function of IGBT turn on gate resistor

$$di_f/dt, di_{rec}/dt = f(R_{gon})$$

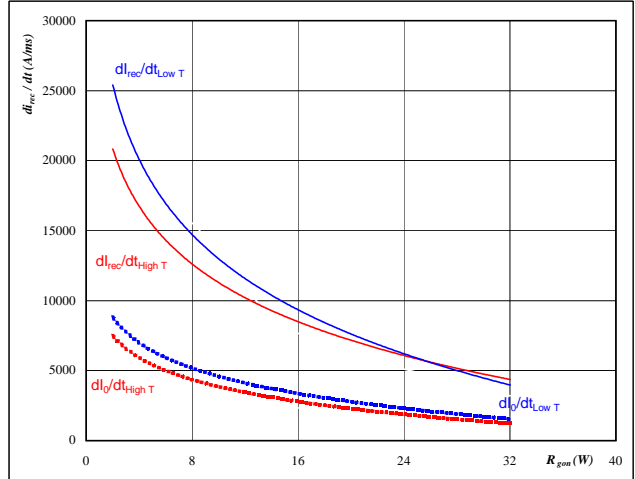

At

$T_j =$	25/125	°C
$V_R =$	350	V
$I_F =$	30	A
$V_{GE} =$	15	V

Figure 19 MOSFET

IGBT transient thermal impedance as a function of pulse width

$$Z_{thJH} = f(t_p)$$

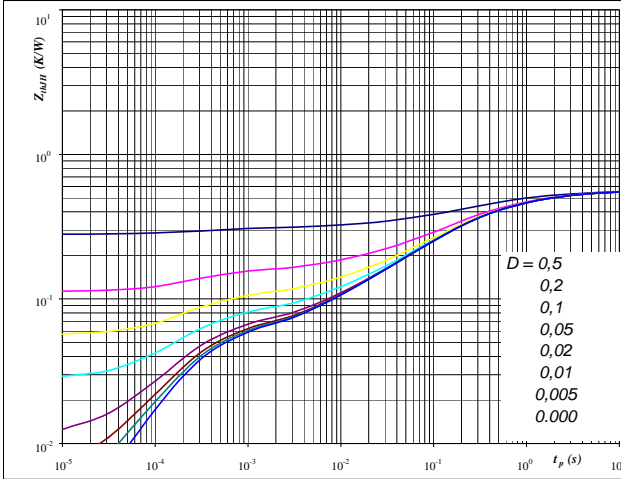

At

$D =$	t_p / T	
$R_{thJH} =$	0,56	K/W

IGBT thermal model values

R (C/W)	Tau (s)
0,04	8,6E+00
0,13	1,4E+00
0,23	2,2E-01
0,09	3,6E-02
0,03	5,0E-03
0,05	2,6E-04

Figure 20 FRED

FRED transient thermal impedance as a function of pulse width

$$Z_{thJH} = f(t_p)$$

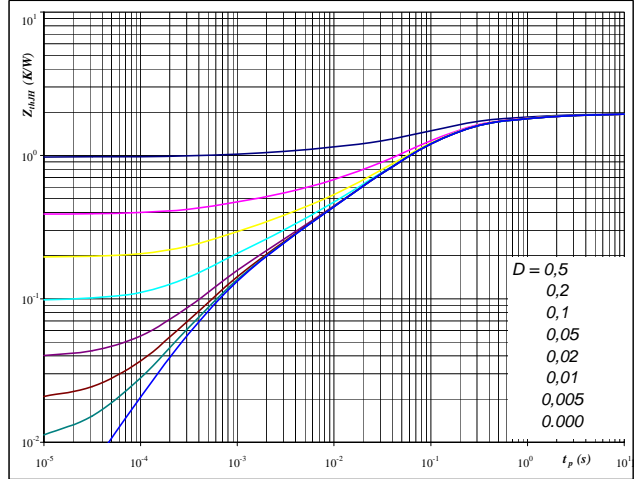

At

$D =$	t_p / T	
$R_{thJH} =$	1,95	K/W

FRED thermal model values

R (C/W)	Tau (s)
0,06	7,9E+00
0,24	1,0E+00
0,90	1,4E-01
0,50	3,1E-02
0,17	3,7E-03
0,09	5,7E-04

Buck

Figure 21 MOSFET

Power dissipation as a function of heatsink temperature

$$P_{tot} = f(T_h)$$

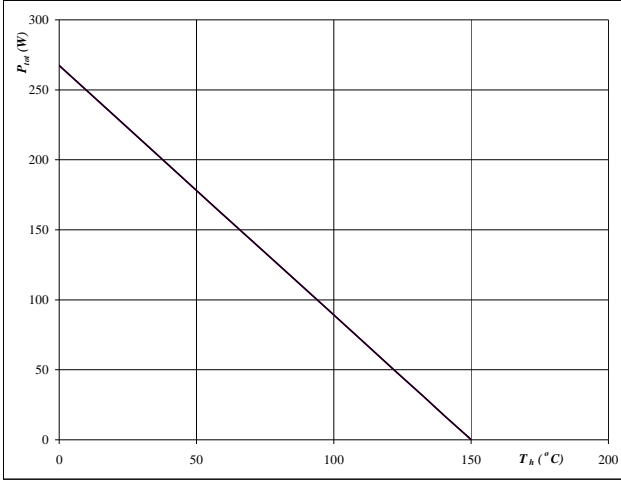

At $T_j = 150$ °C

— single heating
 — overall heating

Figure 22 MOSFET

Collector current as a function of heatsink temperature

$$I_C = f(T_h)$$

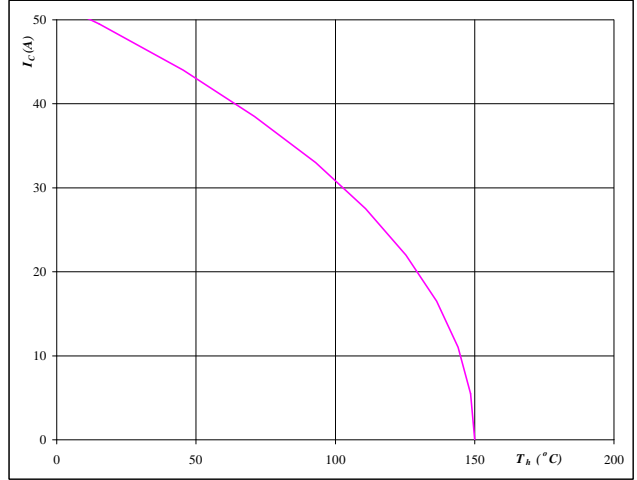

At $T_j = 150$ °C

$V_{GE} = 15$ V

Figure 23 FRED

Power dissipation as a function of heatsink temperature

$$P_{tot} = f(T_h)$$

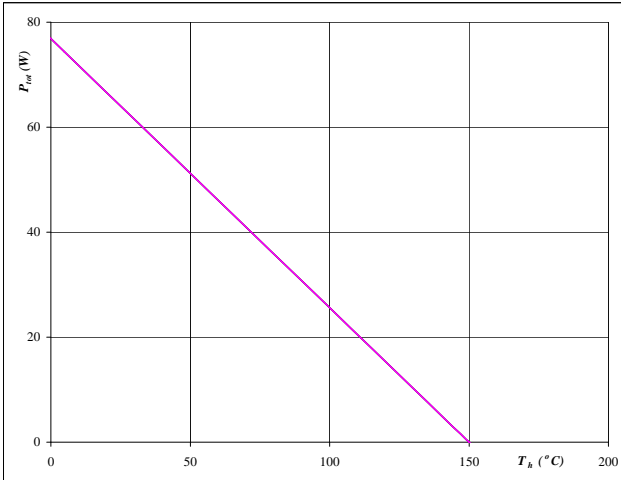

At $T_j = 150$ °C

— single heating
 — overall heating

Figure 24 FRED

Forward current as a function of heatsink temperature

$$I_F = f(T_h)$$

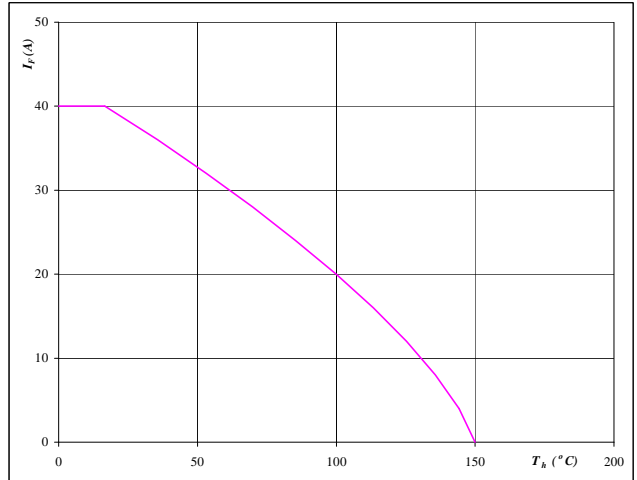

At $T_j = 150$ °C

Buck

Figure 25 MOSFET

Safe operating area as a function of collector-emitter voltage

$$I_C = f(V_{CE})$$

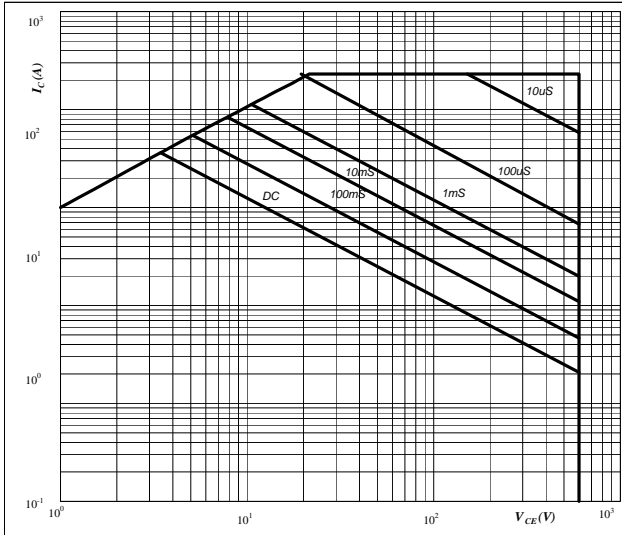

At
 D = single pulse
 Th = 80 °C
 V_{GE} = 15 V
 T_j = T_{jmax} °C

Figure 26 MOSFET

Gate voltage vs Gate charge

$$V_{GE} = f(Q_g)$$

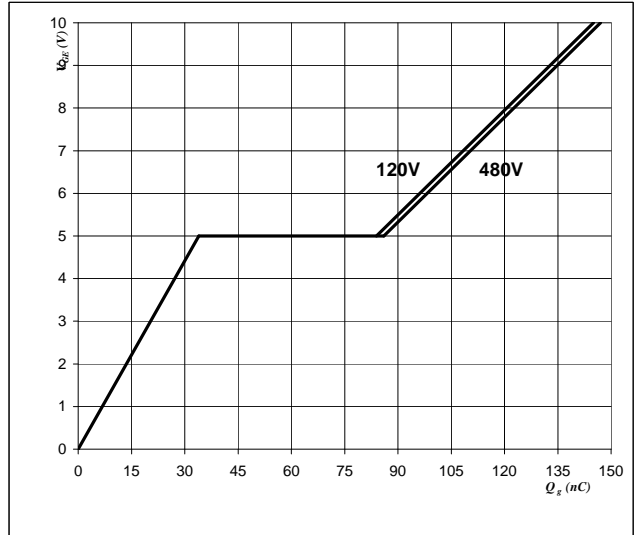

At
 I_C = 30 A

Boost

Figure 1 IGBT

Typical output characteristics

$$I_C = f(V_{CE})$$



At
 $t_p = 250 \mu\text{s}$
 $T_j = 25 \text{ }^\circ\text{C}$
 V_{GE} from 7 V to 17 V in steps of 1 V

Figure 2 IGBT

Typical output characteristics

$$I_C = f(V_{CE})$$

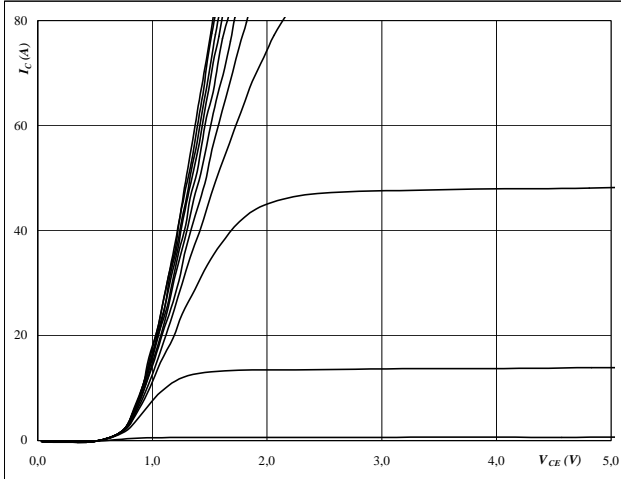

At
 $t_p = 250 \mu\text{s}$
 $T_j = 125 \text{ }^\circ\text{C}$
 V_{GE} from 7 V to 17 V in steps of 1 V

Figure 3 IGBT

Typical transfer characteristics

$$I_C = f(V_{GE})$$

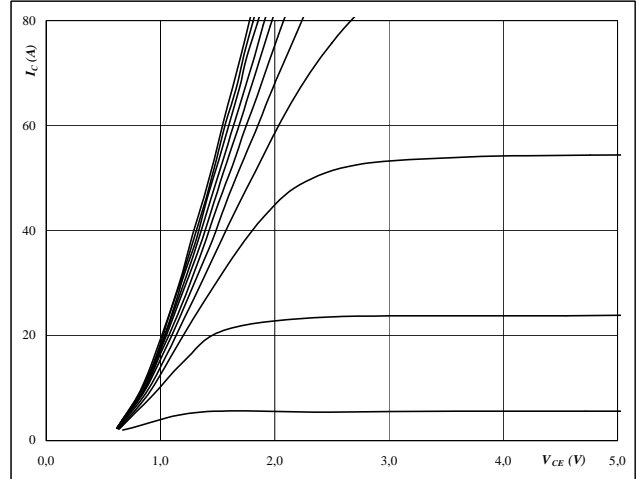
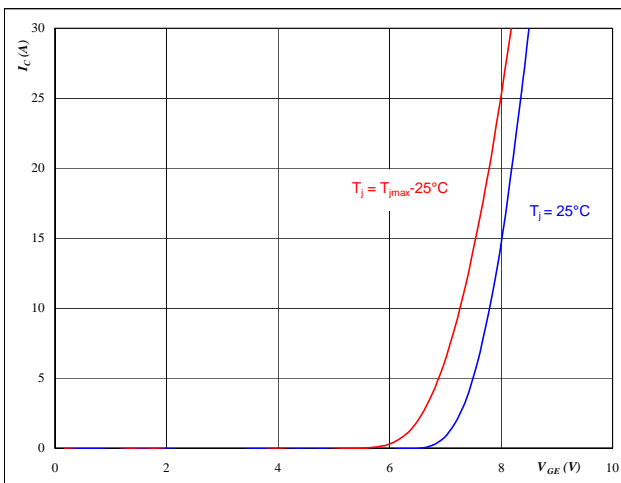
At
 $t_p = 250 \mu\text{s}$
 $V_{CE} = 10 \text{ V}$
Figure 4 FRED

Typical diode forward current as a function of forward voltage

$$I_F = f(V_F)$$

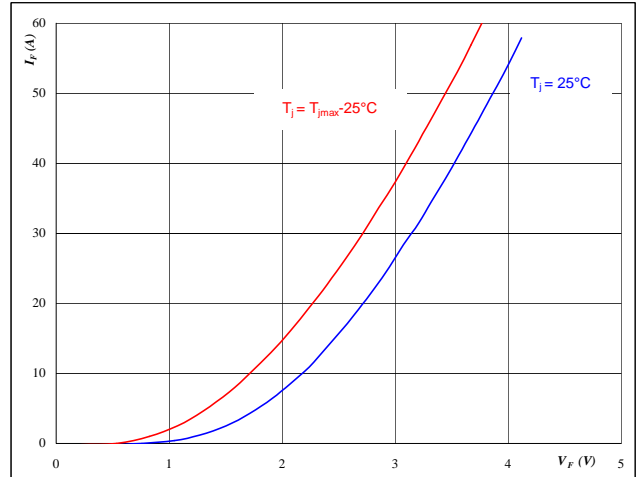

At
 $t_p = 250 \mu\text{s}$

Boost

Figure 5 IGBT

Typical switching energy losses
 as a function of collector current

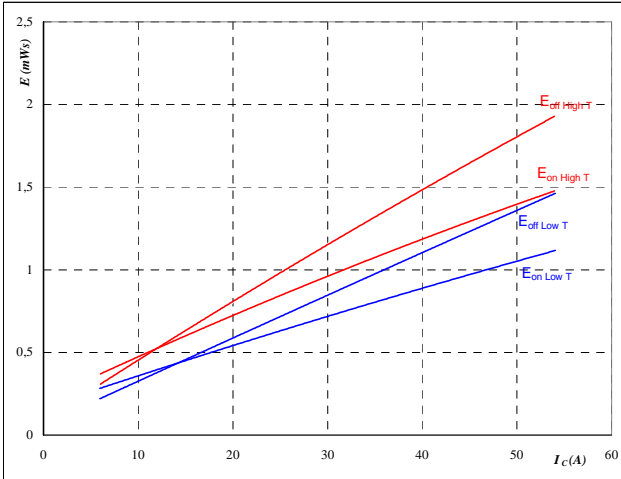
$$E = f(I_C)$$



With an inductive load at

$T_J =$	25/125	°C
$V_{CE} =$	350	V
$V_{GE} =$	15	V
$R_{gon} =$	8	Ω
$R_{goff} =$	8	Ω

Figure 6 IGBT

Typical switching energy losses
 as a function of gate resistor

$$E = f(R_G)$$

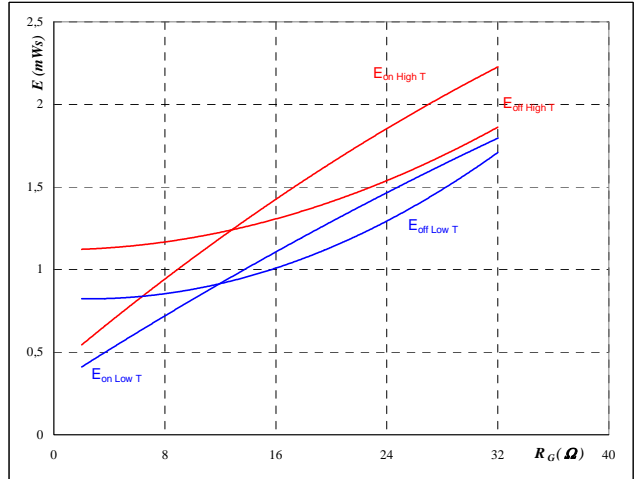

With an inductive load at

$T_J =$	25/125	°C
$V_{CE} =$	350	V
$V_{GE} =$	15	V
$I_C =$	30	A

Figure 7 IGBT

Typical reverse recovery energy loss
 as a function of collector current

$$E_{rec} = f(I_C)$$

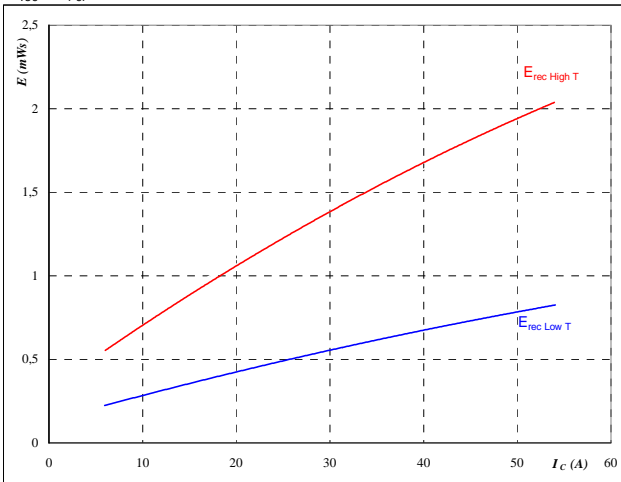

With an inductive load at

$T_J =$	25/125	°C
$V_{CE} =$	350	V
$V_{GE} =$	15	V
$R_{gon} =$	8	Ω

Figure 8 IGBT

Typical reverse recovery energy loss
 as a function of gate resistor

$$E_{rec} = f(R_G)$$

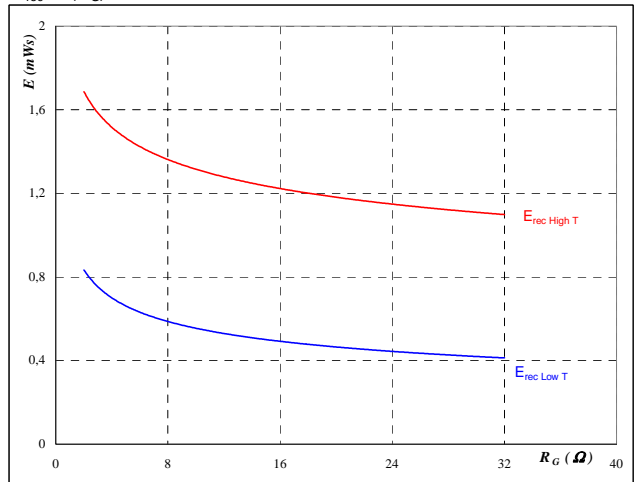

With an inductive load at

$T_J =$	25/125	°C
$V_{CE} =$	350	V
$V_{GE} =$	15	V
$I_C =$	30	A

Boost

Figure 9 IGBT

Typical switching times as a function of collector current

$t = f(I_C)$

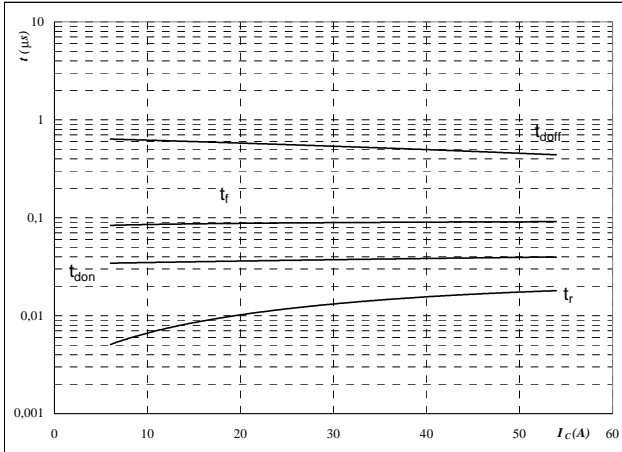

With an inductive load at

$T_j =$	25/125	°C
$V_{CE} =$	350	V
$V_{GE} =$	15	V
$R_{gon} =$	8	Ω
$R_{goff} =$	8	Ω

Figure 10 IGBT

Typical switching times as a function of gate resistor

$t = f(R_G)$

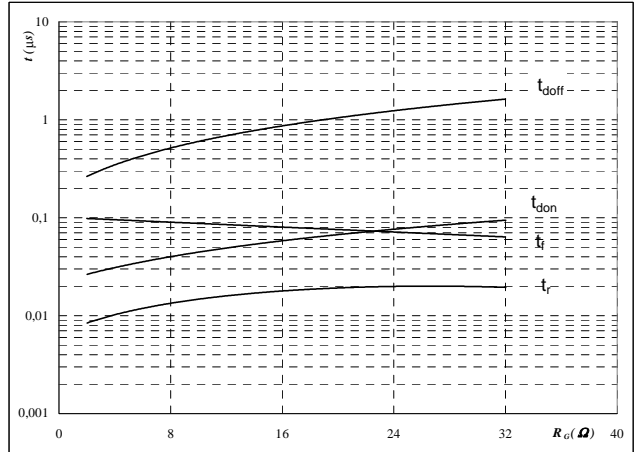

With an inductive load at

$T_j =$	25/125	°C
$V_{CE} =$	350	V
$V_{GE} =$	15	V
$I_C =$	30	A

Figure 11 FRED

Typical reverse recovery time as a function of collector current

$t_{rr} = f(I_C)$

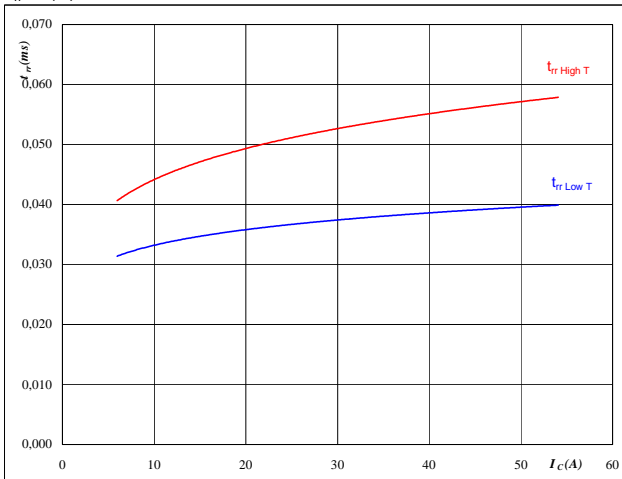

At

$T_j =$	25/125	°C
$V_{CE} =$	350	V
$V_{GE} =$	15	V
$R_{gon} =$	8	Ω

Figure 12 FRED

Typical reverse recovery time as a function of IGBT turn on gate resistor

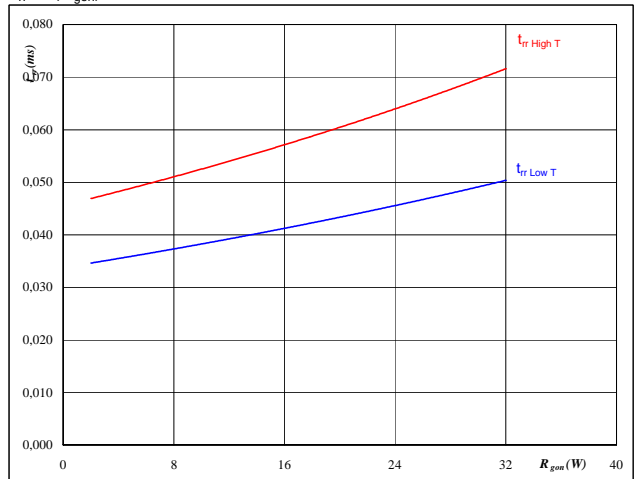
$t_{rr} = f(R_{gon})$

At

$T_j =$	25/125	°C
$V_R =$	350	V
$I_F =$	30	A
$V_{GE} =$	15	V

Boost

Figure 13 FRED

Typical reverse recovery charge as a function of collector current

$$Q_{rr} = f(I_c)$$

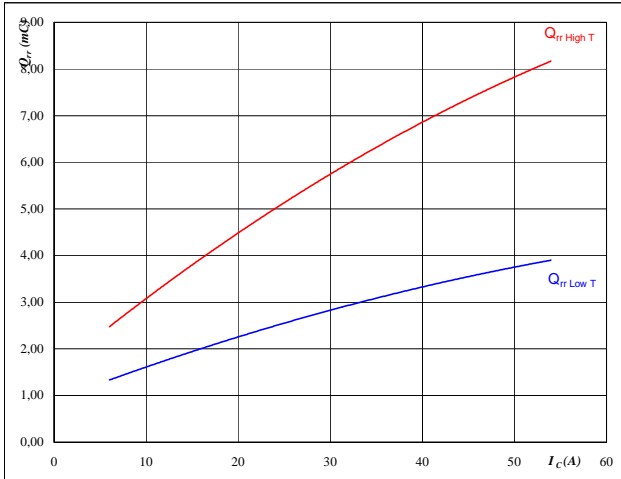

At
 $T_j = 25/125$ °C
 $V_{CE} = 350$ V
 $V_{GE} = 15$ V
 $R_{gon} = 8$ Ω

Figure 14 FRED

Typical reverse recovery charge as a function of IGBT turn on gate resistor

$$Q_{rr} = f(R_{gon})$$

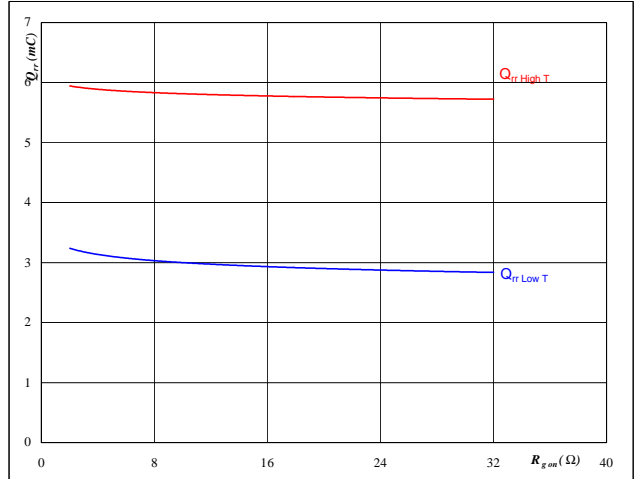

At
 $T_j = 25/125$ °C
 $V_R = 350$ V
 $I_F = 30$ A
 $V_{GE} = 15$ V

Figure 15 FRED

Typical reverse recovery current as a function of collector current

$$I_{RRM} = f(I_c)$$

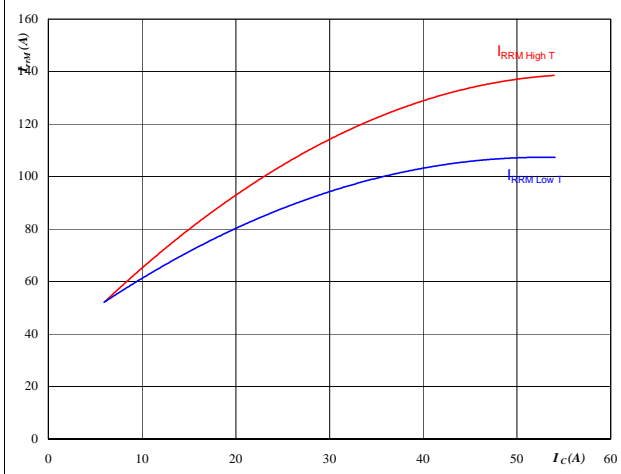

At
 $T_j = 25/125$ °C
 $V_{CE} = 350$ V
 $V_{GE} = 15$ V
 $R_{gon} = 8$ Ω

Figure 16 FRED

Typical reverse recovery current as a function of IGBT turn on gate resistor

$$I_{RRM} = f(R_{gon})$$

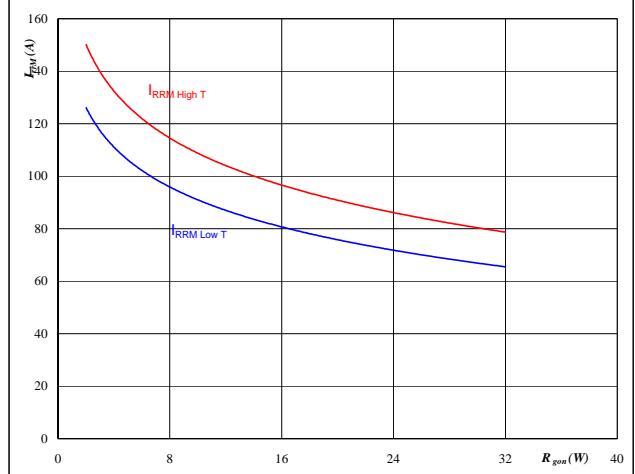

At
 $T_j = 25/125$ °C
 $V_R = 350$ V
 $I_F = 30$ A
 $V_{GE} = 15$ V

Boost

Figure 17 FRED

Typical rate of fall of forward and reverse recovery current as a function of collector current

$$di_f/dt, di_{rec}/dt = f(I_c)$$

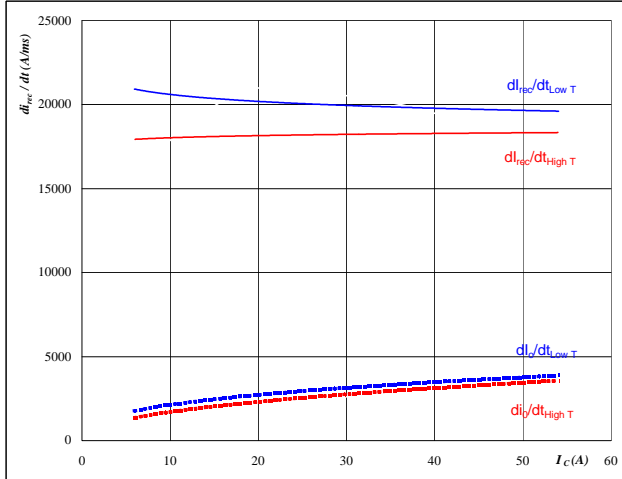

At
T_j = 25/125 °C
V_{CE} = 350 V
V_{GE} = 15 V
R_{gon} = 8 Ω

Figure 18 FRED

Typical rate of fall of forward and reverse recovery current as a function of IGBT turn on gate resistor

$$di_f/dt, di_{rec}/dt = f(R_{gon})$$

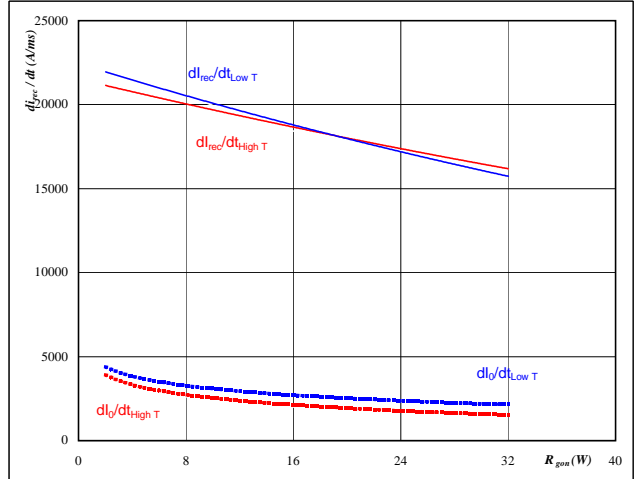

At
T_j = 25/125 °C
V_R = 350 V
I_F = 30 A
V_{GE} = 15 V

Figure 19 IGBT

IGBT transient thermal impedance as a function of pulse width

$$Z_{thJH} = f(t_p)$$

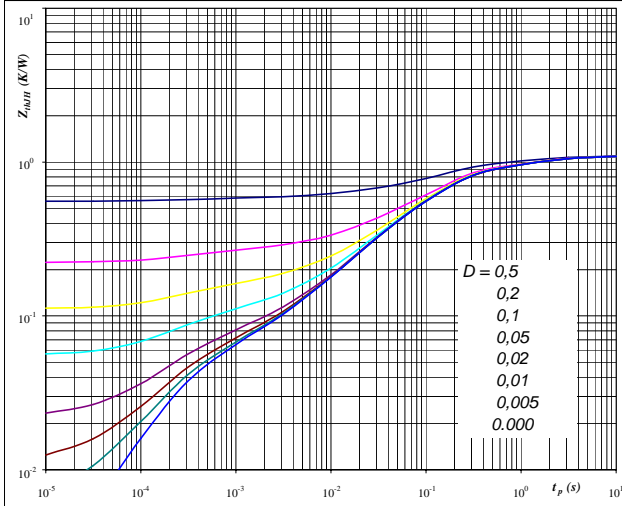

At
D = t_p / T
R_{thJH} = 1,11 K/W

IGBT thermal model values

R (C/W)	Tau (s)
0,06	9,9E+00
0,22	1,2E+00
0,59	1,4E-01
0,17	2,2E-02
0,03	2,7E-03
0,04	2,7E-04

Figure 20 FRED

FRED transient thermal impedance as a function of pulse width

$$Z_{thJH} = f(t_p)$$

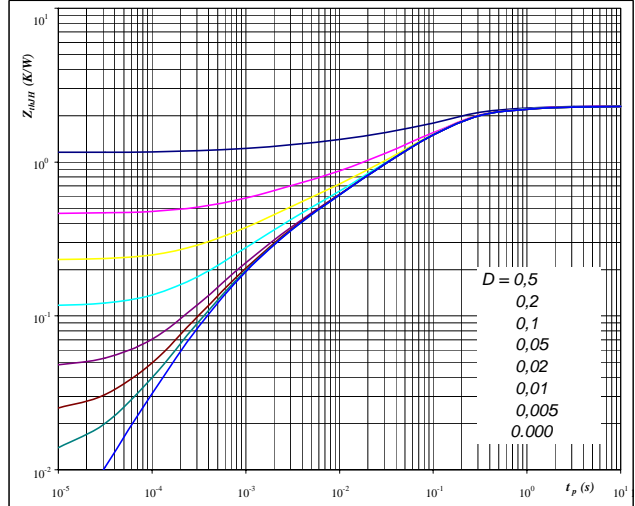

At
D = t_p / T
R_{thJH} = 2,32 K/W

FRED thermal model values

R (C/W)	Tau (s)
0,04	9,8E+00
0,25	7,7E-01
1,24	1,2E-01
0,44	2,0E-02
0,25	2,6E-03
0,09	4,3E-04

Boost

Figure 21 IGBT

Power dissipation as a function of heatsink temperature

$$P_{tot} = f(T_h)$$



At
 $T_j = 175$ °C

Figure 22 IGBT

Collector current as a function of heatsink temperature

$$I_C = f(T_h)$$

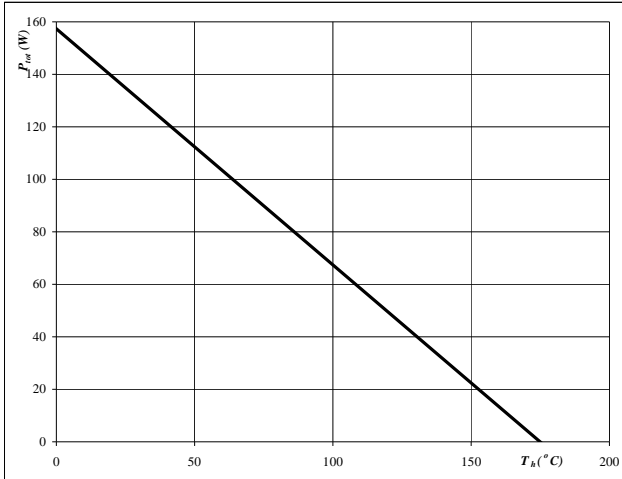

At
 $T_j = 175$ °C
 $V_{GE} = 15$ V

Figure 23 FRED

Power dissipation as a function of heatsink temperature

$$P_{tot} = f(T_h)$$

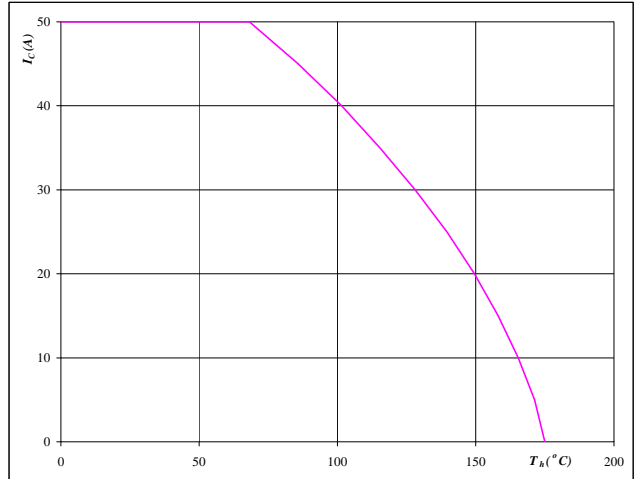

At
 $T_j = 150$ °C

Figure 24 FRED

Forward current as a function of heatsink temperature

$$I_F = f(T_h)$$

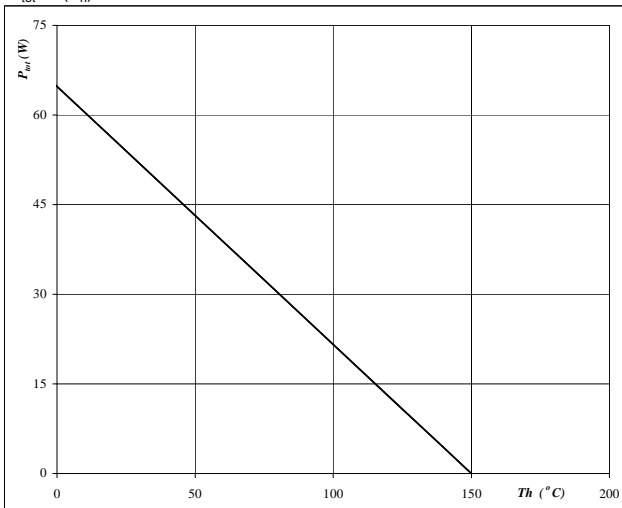
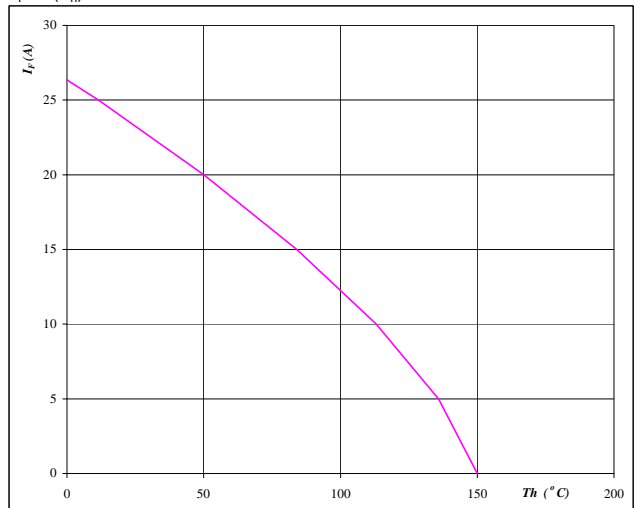

At
 $T_j = 150$ °C

Boost

Figure 25 Boost Inverse Diode

Typical diode forward current as a function of forward voltage

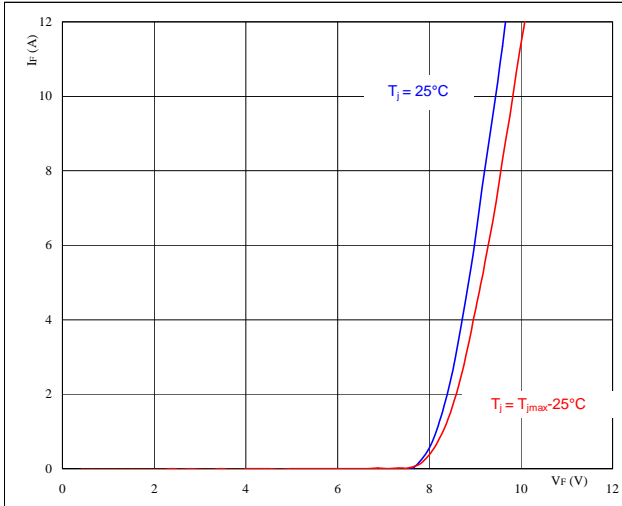
$$I_F = f(V_F)$$



At
 $t_p = 250 \mu\text{s}$

Figure 26 Boost Inverse Diode

Diode transient thermal impedance as a function of pulse width

$$Z_{thJH} = f(t_p)$$

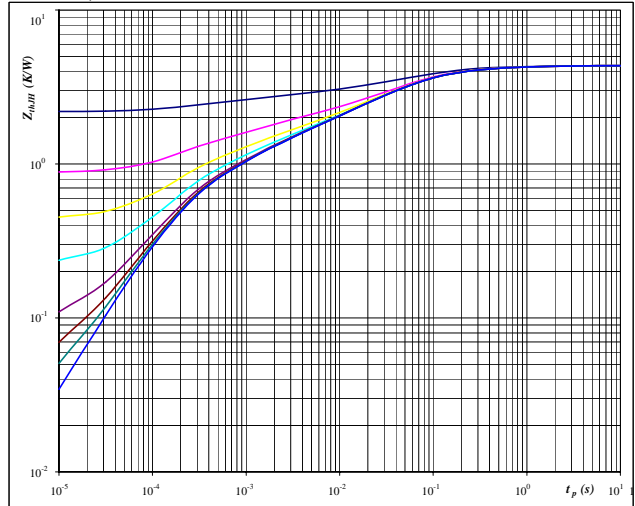

At
 $D = t_p / T$
 $R_{thJH} = 4,36 \text{ K/W}$

Thermistor

Figure 1 Thermistor

Typical NTC characteristic
 as a function of temperature

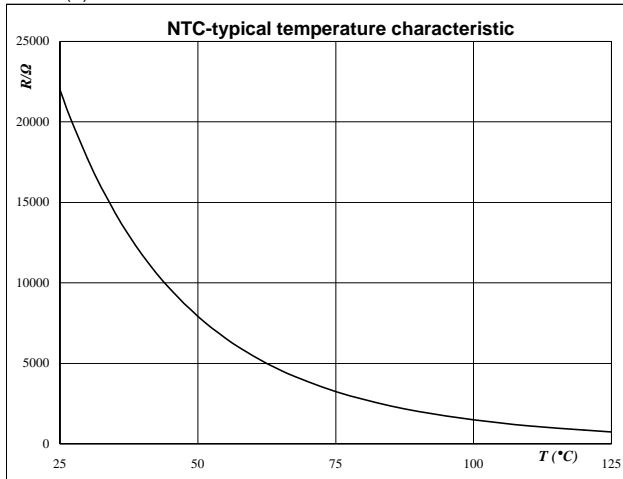
 $R_T = f(T)$

Figure 2 Thermistor

Typical NTC resistance values

$$R(T) = R_{25} \cdot e^{\left(B_{25/100} \left(\frac{1}{T} - \frac{1}{T_{25}} \right) \right)} \quad [\Omega]$$

T [°C]	R_soll [Ω]	R_min [Ω]	R_max [Ω]	ΔR/R [+-%]
-50	1458070,6	1069249,3	1846891,9	26,7
0	71804,2	59724,4	83884	16,8
10	43780,4	37094,4	50466,5	15,3
20	27484,6	23684,6	31284,7	13,8
25	22000	19109,3	24890,7	13,1
30	17723,3	15512,2	19934,4	12,5
60	5467,9	4980,6	5955,1	8,9
70	3848,6	3546	4151,1	7,9
80	2757,7	2568,2	2947,1	6,9
90	2008,9	1889,7	2128,2	5,9
100	1486,1	1411,8	1560,4	5
150	400,2	364,8	435,7	8,8

Switching Definitions BUCK MOSFET

General conditions

T_j	=	125 °C
R_{gon}	=	8 Ω
R_{goff}	=	8 Ω

Figure 1 BUCK MOSFET

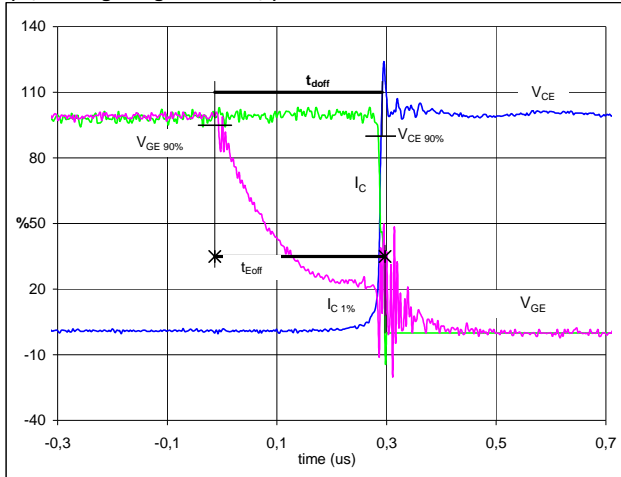
Turn-off Switching Waveforms & definition of t_{doff} , t_{Eoff}
 (t_{Eoff} = integrating time for E_{off})

$V_{GS}(0\%)$	=	0	V
$V_{GS}(100\%)$	=	15	V
$V_D(100\%)$	=	350	V
$I_D(100\%)$	=	30	A
t_{doff}	=	0,30	μs
t_{Eoff}	=	0,31	μs

Figure 2 BUCK MOSFET

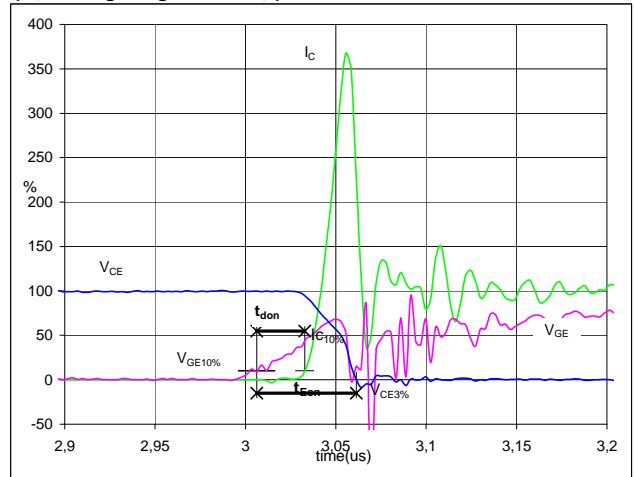
Turn-on Switching Waveforms & definition of t_{don} , t_{Eon}
 (t_{Eon} = integrating time for E_{on})

$V_{GS}(0\%)$	=	0	V
$V_{GS}(100\%)$	=	15	V
$V_D(100\%)$	=	350	V
$I_D(100\%)$	=	30	A
t_{don}	=	0,04	μs
t_{Eon}	=	0,05	μs

Figure 3 BUCK MOSFET

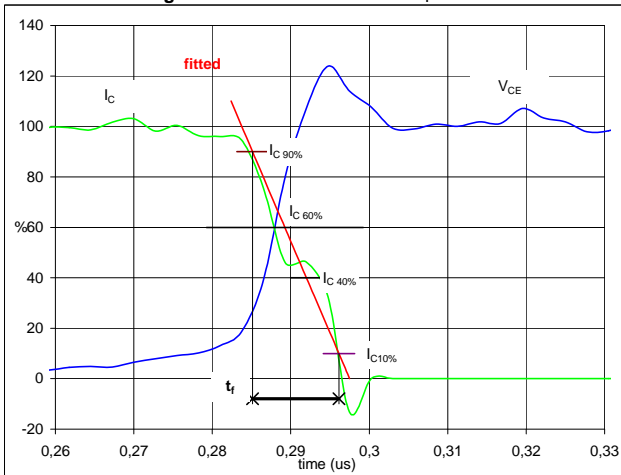
Turn-off Switching Waveforms & definition of t_f

$V_D(100\%)$	=	350	V
$I_D(100\%)$	=	30	A
t_f	=	0,01	μs

Figure 4 BUCK MOSFET

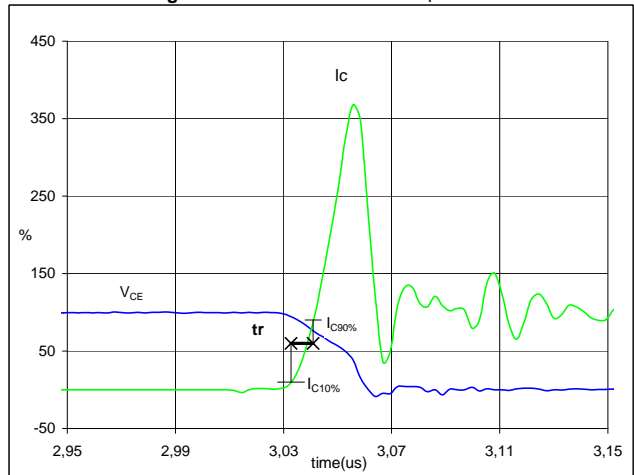
Turn-on Switching Waveforms & definition of t_r

$V_D(100\%)$	=	350	V
$I_D(100\%)$	=	30	A
t_r	=	0,01	μs

Switching Definitions BUCK MOSFET

Figure 5 BUCK MOSFET

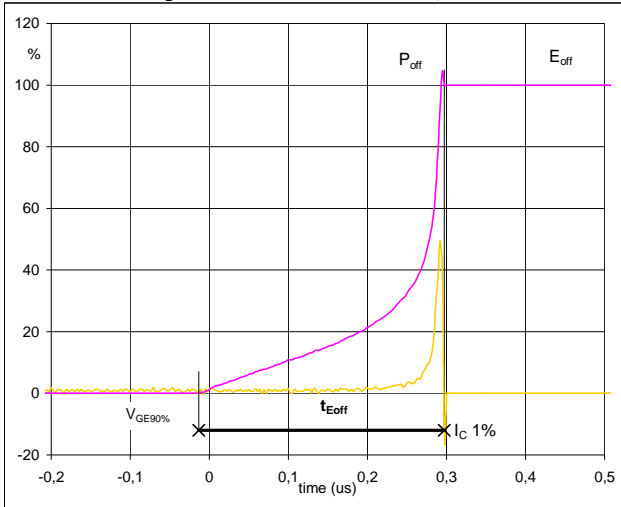
Turn-off Switching Waveforms & definition of t_{Eoff}

$P_{off} (100\%) = 10,48 \text{ kW}$
 $E_{off} (100\%) = 0,11 \text{ mJ}$
 $t_{Eoff} = 0,31 \text{ }\mu\text{s}$

Figure 6 BUCK MOSFET

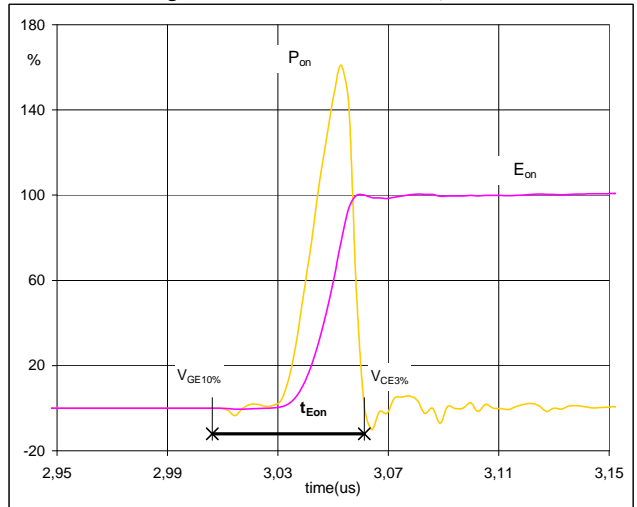
Turn-on Switching Waveforms & definition of t_{Eon}

$P_{on} (100\%) = 10,48 \text{ kW}$
 $E_{on} (100\%) = 0,27 \text{ mJ}$
 $t_{Eon} = 0,05 \text{ }\mu\text{s}$

Figure 7 BUCK MOSFET

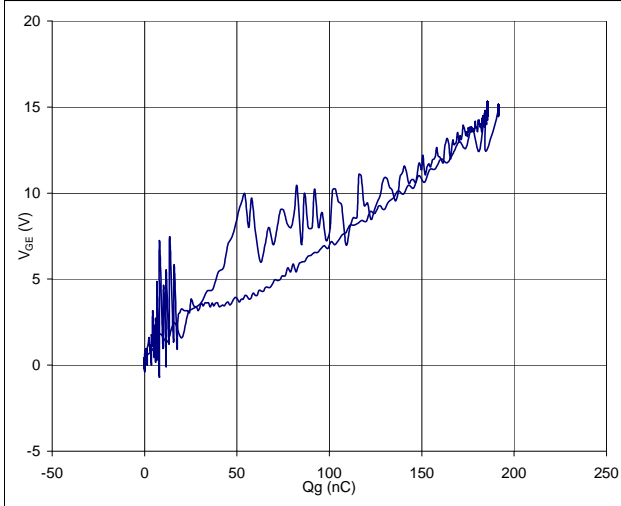
Gate voltage vs Gate charge (measured)

$V_{GSoff} = 0 \text{ V}$
 $V_{GSon} = 15 \text{ V}$
 $V_C (100\%) = 350 \text{ V}$
 $I_D (100\%) = 30 \text{ A}$
 $Q_g = 191,44 \text{ nC}$

Figure 8 BUCK FRED

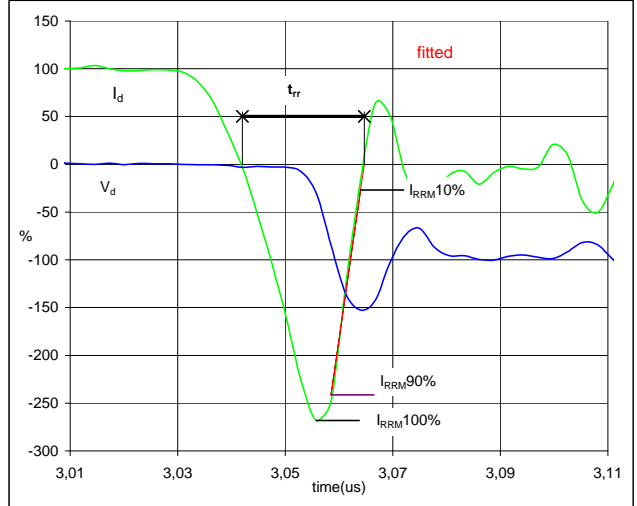
Turn-off Switching Waveforms & definition of t_{rr}

$V_d (100\%) = 350 \text{ V}$
 $I_d (100\%) = 30 \text{ A}$
 $I_{RRM} (100\%) = -70 \text{ A}$
 $t_{rr} = 0,02 \text{ }\mu\text{s}$

Switching Definitions BUCK MOSFET

Figure 9 BUCK FRED

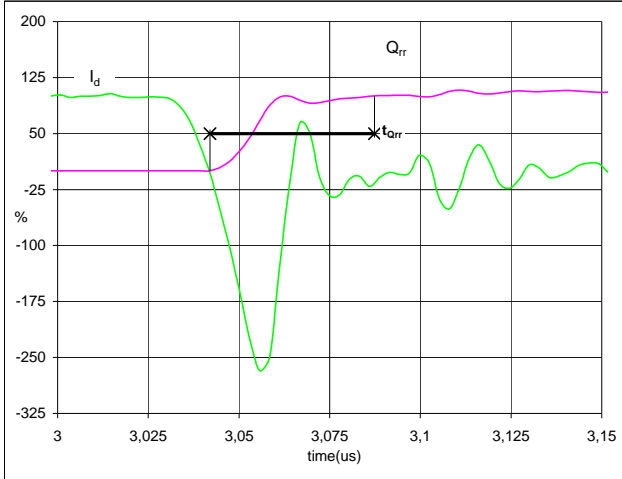
Turn-on Switching Waveforms & definition of t_{Qrr}
 (t_{Qrr} = integrating time for Q_{rr})

I_d (100%) =	30	A
Q_{rr} (100%) =	0,98	μC
t_{Qrr} =	0,05	μs

Figure 10 BUCK FRED

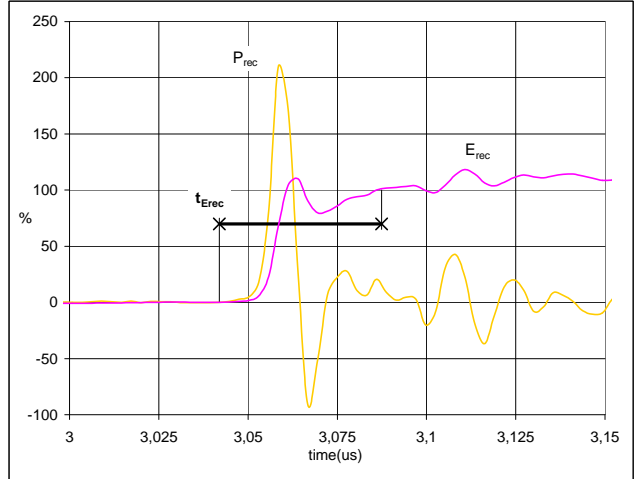
Turn-on Switching Waveforms & definition of t_{Erec}
 (t_{Erec} = integrating time for E_{rec})

P_{rec} (100%) =	10,48	kW
E_{rec} (100%) =	0,31	mJ
t_{Erec} =	0,05	μs

Measurement circuits

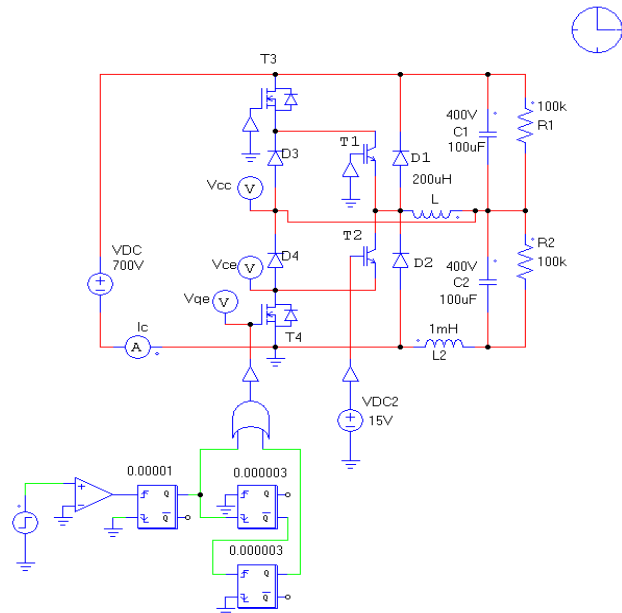
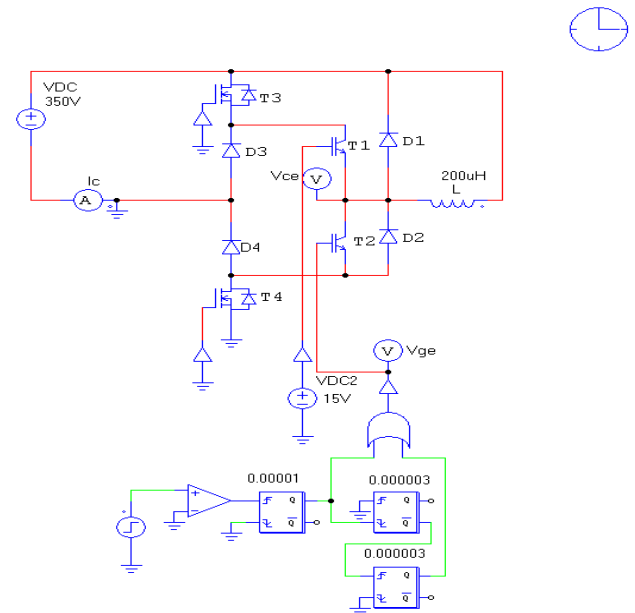
Figure 11
BUCK stage switching measurement circuit

Figure 12
BOOST stage switching measurement circuit

Switching Definitions Boost IGBT

General conditions

T_j	=	125 °C
R_{gon}	=	8 Ω
R_{goff}	=	8 Ω

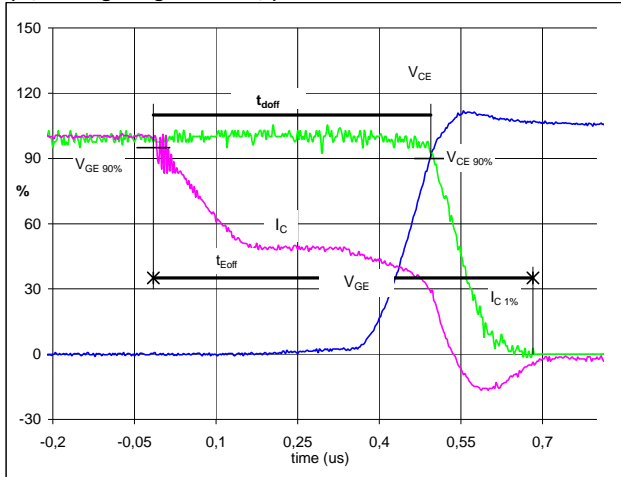
Figure 1 BOOST IGBT

Turn-off Switching Waveforms & definition of t_{doff} , t_{Eoff}
 (t_{Eoff} = integrating time for E_{off})

V_{GE} (0%) =	0	V
V_{GE} (100%) =	15	V
V_C (100%) =	350	V
I_C (100%) =	30	A
t_{doff} =	0,50	μ s
t_{Eoff} =	0,70	μ s

Figure 2 BOOST IGBT

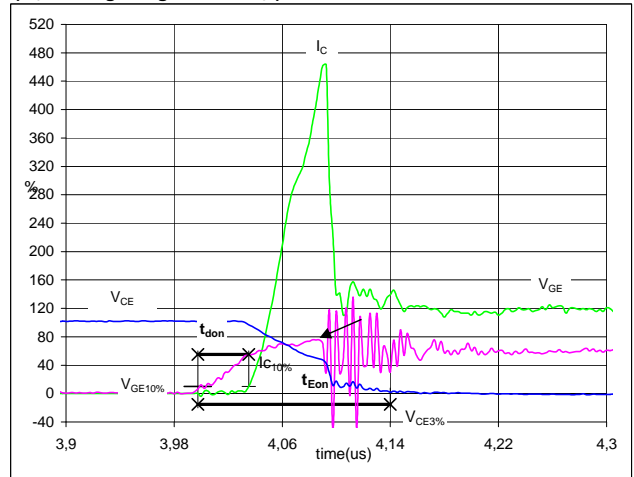
Turn-on Switching Waveforms & definition of t_{don} , t_{Eon}
 (t_{Eon} = integrating time for E_{on})

V_{GE} (0%) =	0	V
V_{GE} (100%) =	15	V
V_C (100%) =	350	V
I_C (100%) =	30	A
t_{don} =	0,04	μ s
t_{Eon} =	0,14	μ s

Figure 3 BOOST IGBT

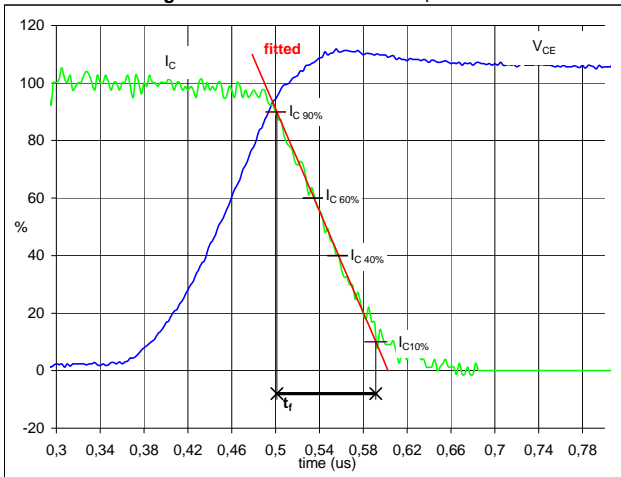
Turn-off Switching Waveforms & definition of t_f

V_C (100%) =	350	V
I_C (100%) =	30	A
t_f =	0,09	μ s

Figure 4 BOOST IGBT

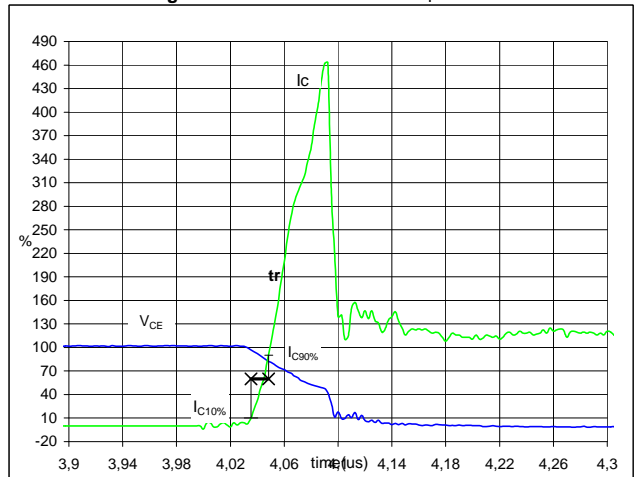
Turn-on Switching Waveforms & definition of t_r

V_C (100%) =	350	V
I_C (100%) =	30	A
t_r =	0,01	μ s

Switching Definitions Boost IGBT

Figure 5 BOOST IGBT

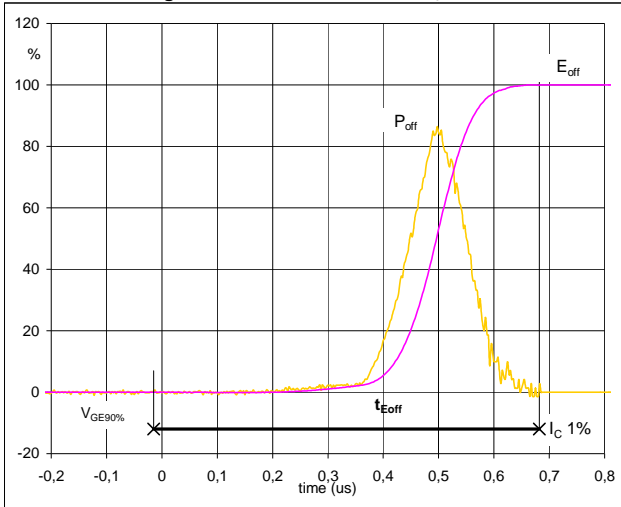
Turn-off Switching Waveforms & definition of t_{Eoff}

$P_{off} (100\%) = 10,55 \text{ kW}$
 $E_{off} (100\%) = 1,16 \text{ mJ}$
 $t_{Eoff} = 0,70 \text{ } \mu\text{s}$

Figure 6 BOOST IGBT

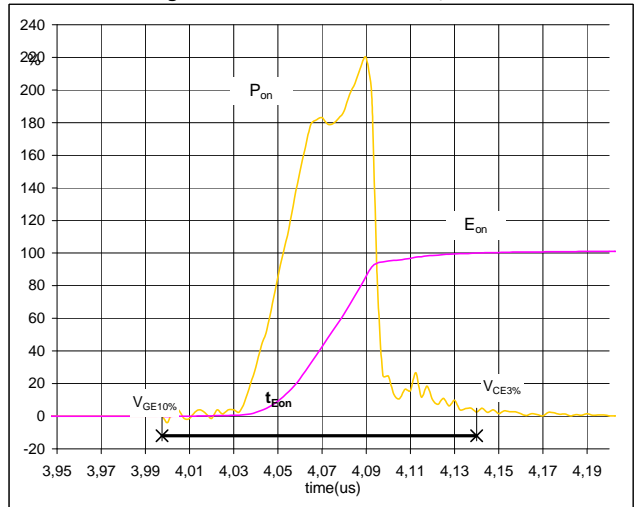
Turn-on Switching Waveforms & definition of t_{Eon}

$P_{on} (100\%) = 10,55 \text{ kW}$
 $E_{on} (100\%) = 0,96 \text{ mJ}$
 $t_{Eon} = 0,14 \text{ } \mu\text{s}$

Figure 7 BOOST IGBT

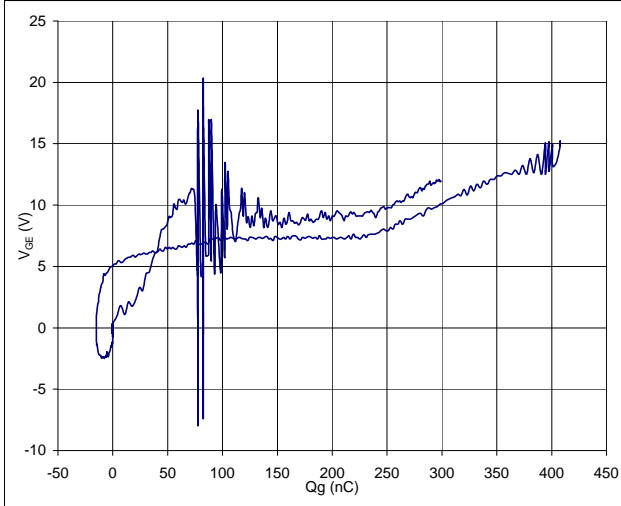
Gate voltage vs Gate charge (measured)

$V_{GEoff} = 0 \text{ V}$
 $V_{GEon} = 15 \text{ V}$
 $V_C (100\%) = 350 \text{ V}$
 $I_C (100\%) = 30 \text{ A}$
 $Q_g = 407,76 \text{ nC}$

Figure 8 BOOST FRED

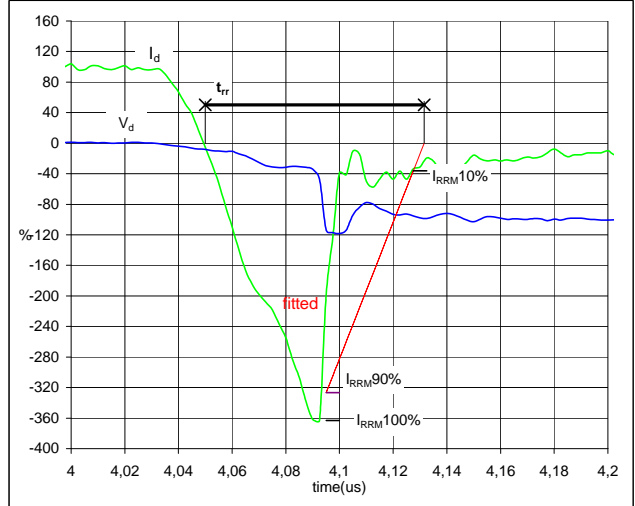
Turn-off Switching Waveforms & definition of t_{rr}

$V_d (100\%) = 350 \text{ V}$
 $I_d (100\%) = 30 \text{ A}$
 $I_{RRM} (100\%) = -112 \text{ A}$
 $t_{rr} = 0,05 \text{ } \mu\text{s}$

Switching Definitions Boost IGBT

Figure 9 BOOST FRED

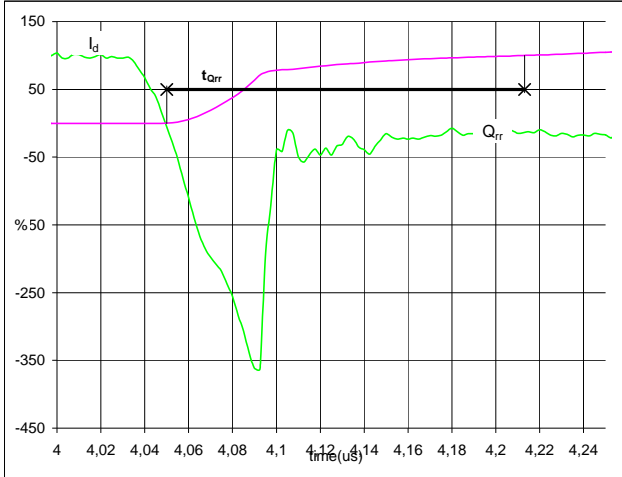
Turn-on Switching Waveforms & definition of t_{Qrr}
 (t_{Qrr} = integrating time for Q_{rr})

I_d (100%) =	30	A
Q_{rr} (100%) =	5,74	μ C
t_{Qrr} =	0,16	μ s

Figure 10 BOOST FRED

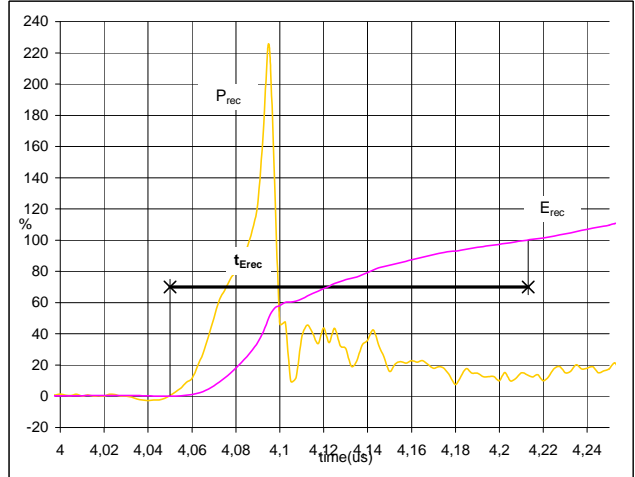
Turn-on Switching Waveforms & definition of t_{Erec}
 (t_{Erec} = integrating time for E_{rec})

P_{rec} (100%) =	10,55	kW
E_{rec} (100%) =	1,39	mJ
t_{Erec} =	0,16	μ s

Measurement circuits

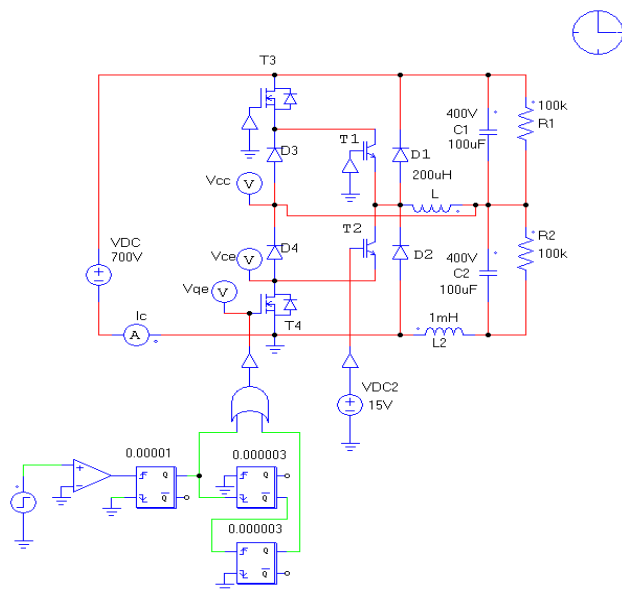
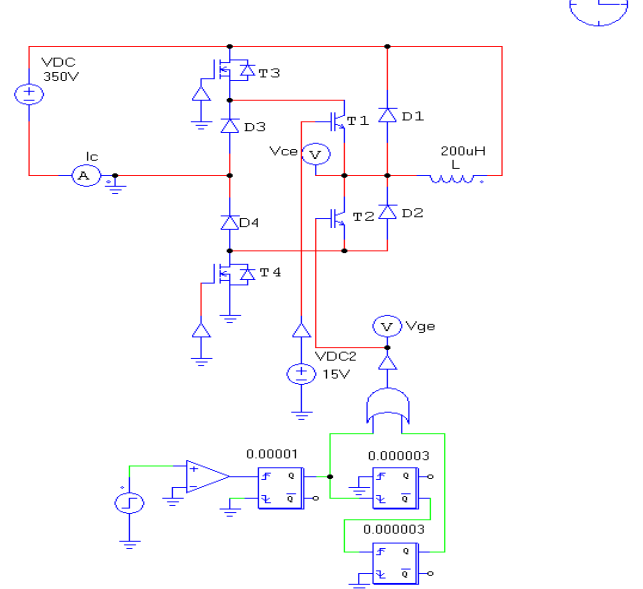
Figure 11
BUCK stage switching measurement circuit

Figure 12
BOOST stage switching measurement circuit

Ordering Code and Marking - Outline - Pinout
Ordering Code & Marking

Version	Ordering Code	in DataMatrix as	in packaging barcode as
without thermal paste 12mm housing	10-FZ06NRA045FH01-P965F10	P965F10	P965F10

Outline

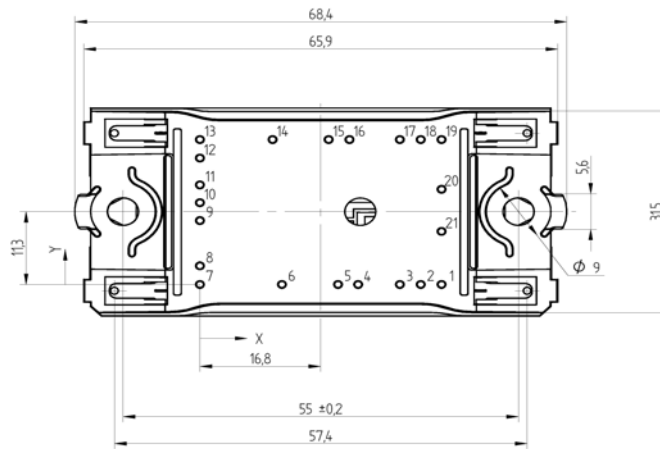
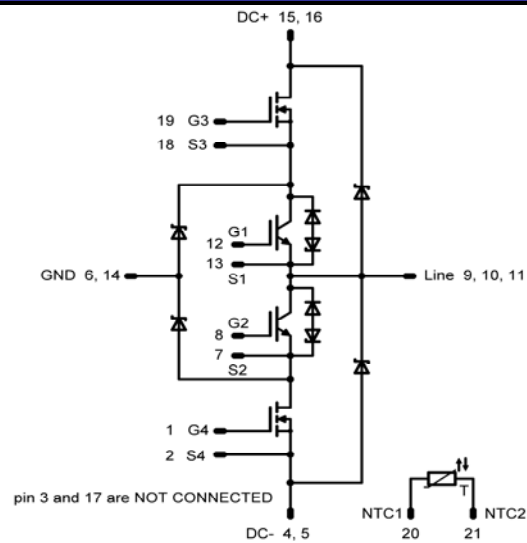
Pin table		
Pin	X	Y
1	33,6	0
2	30,7	0
3	27,8	0
4	22	0
5	19,2	0
6	11,4	0
7	0	0
8	0	2,9
9	0	9,9
10	0	12,7
11	0	15,5
12	0	19,7
13	0	22,6
14	10,1	22,6
15	17,9	22,6
16	20,8	22,6
17	27,8	22,6
18	30,7	22,6
19	33,6	22,6
20	33,6	14,8
21	33,6	8,2

Pinout

PRODUCT STATUS DEFINITIONS

Datasheet Status	Product Status	Definition
Target	Formative or In Design	This datasheet contains the design specifications for product development. Specifications may change in any manner without notice. The data contained is exclusively intended for technically trained staff.
Preliminary	First Production	This datasheet contains preliminary data, and supplementary data may be published at a later date. Vincotech reserves the right to make changes at any time without notice in order to improve design. The data contained is exclusively intended for technically trained staff.
Final	Full Production	This datasheet contains final specifications. Vincotech reserves the right to make changes at any time without notice in order to improve design. The data contained is exclusively intended for technically trained staff.

DISCLAIMER

The information given in this datasheet describes the type of component and does not represent assured characteristics. For tested values please contact Vincotech. Vincotech reserves the right to make changes without further notice to any products herein to improve reliability, function or design. Vincotech does not assume any liability arising out of the application or use of any product or circuit described herein; neither does it convey any license under its patent rights, nor the rights of others.

LIFE SUPPORT POLICY

Vincotech products are not authorised for use as critical components in life support devices or systems without the express written approval of Vincotech.

As used herein:

1. Life support devices or systems are devices or systems which, (a) are intended for surgical implant into the body, or (b) support or sustain life, or (c) whose failure to perform when properly used in accordance with instructions for use provided in labelling can be reasonably expected to result in significant injury to the user.
2. A critical component is any component of a life support device or system whose failure to perform can be reasonably expected to cause the failure of the life support device or system, or to affect its safety or effectiveness.