

Fiber Optic Receiver

OPF520 Series



OPF520 Series

- Low Cost plastic cap package
- Designed to self align in the bore of standard fiber optic receptacles
- Press fit simplifies installation
- Optimized for fiber optic applications using 50 to 200 micron fiber

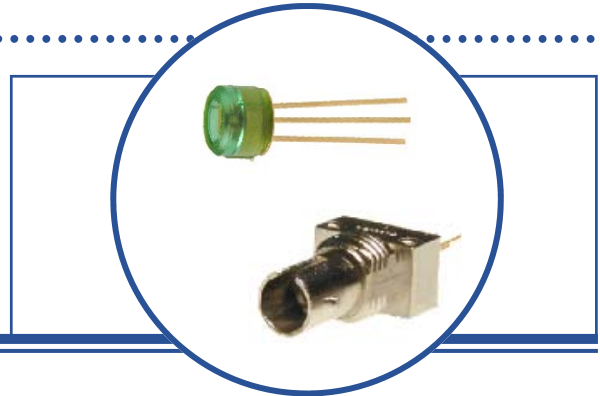

The OPF520 series fiber optic receiver is a high performance device packaged for data communications links. As such, it is designed to work with fiber core diameters from 50µm to 200µm and over a broad input power range. The construction contains a monolithic photo-IC comprised of a photodiode, biasing network, DC amplifier and an open collector output transistor. The output circuitry makes this device compatible with TTL and CMOS logic.

This receiver is designed to operate from a single 5V supply. It is essential that a bypass capacitor be connected from V_{CC} to GND in order to ensure the best possible operation.

Applications

- ◆ Industrial Ethernet equipment
- ◆ Copper-to-fiber media conversion
- ◆ Intra-system fiber optic links
- ◆ Video surveillance systems

Part Ordering Information

Part Number	Description
OPF520	Plastic Cap Component
OPF522	Metal ST Receptacle

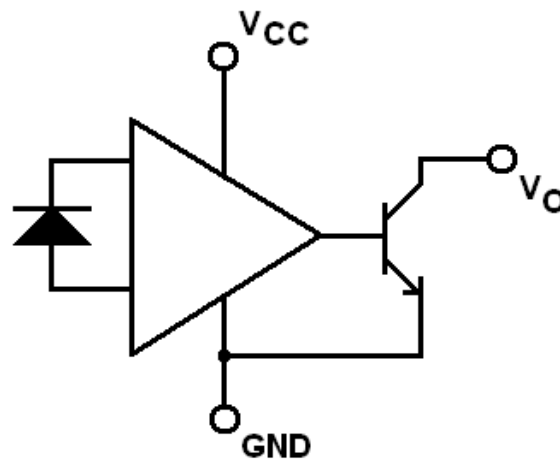

RoHS

OPTEK reserves the right to make changes at any time in order to improve design and to supply the best product possible.

Absolute Maximum Ratings

Storage Temperature.....	-55° C to +115° C
Operating Temperature.....	-40° C to +85° C
Lead Soldering Temperature (for 10 seconds)	260° C
Supply Voltage	-0.5 V to +7.0 V
Output Current	25 mA
Output Voltage	-0.5 V to +18.0 V
Open Collector Power Distribution	40mW
Fan Out (TTL).....	5 ⁽¹⁾

Electrical/Optical Characteristics

4.75 ≤ V_{CC} ≤ 5.25, Fiber Sizes ≤ 200μm, NA ≤ 0.35, T_A = 25°C unless otherwise specified

SYMBOL	PARAMETER	MIN	TYP	MAX	UNITS	CONDITIONS
I _{OH}	High Level Output Current		5	250	μA	V _O = 18V, P _{OC} < -40 dBm, See Note 2
V _{OL}	Low Level Output Voltage		0.2	0.5	V	I _O = 8 mA, P _{OC} > +24 dBm, See Note2
I _{CCH}	Supply Current, Output High		3.5	6.3	mA	V _{CC} = 5.25 V, P _{OC} < -40 dBm, See Note 2
I _{CCL}	Supply Current, Output Low		6.9	10	mA	V _{CC} = 5.25 V, P _{OC} < -24 dBm, See Note 2
P _{OC(H)}	Peak Input Power Level, Output High (Guaranteed Output High)			-40	dBm	λ _p = 850 nm
				0.1	μW	
P _{OC(L)}	Peak Input Power Level, Output Low (Guaranteed Output Low)	-25.4		-9.2	dBm	λ _p = 850 nm, I _O = 8 mA
		2.9		120	μW	
		-24		-10	dBm	λ _p = 850 nm, I _O = 8 mA
		4.0		100	μW	
t _r , t _f	Rise, Fall Time		30		ns	
t _{PDHL}	Propagation Delay, Output High to Low		65		ns	P _{OC} = 20 dBm (peak), f = 2.5 MHz, See Note 3
t _{PDLH}	Propagation Delay, Output Low to High		100		ns	
PWD	Pulse Width Distortion		±30		%	

Notes:

- 8mA load (5 x 1.6 mA), R_L = 560 Ω
- Use recommended test circuit below, but connect V_O to an independent voltage source with R_L = 0.
- Use recommended test circuit below.

Recommended Test Circuit

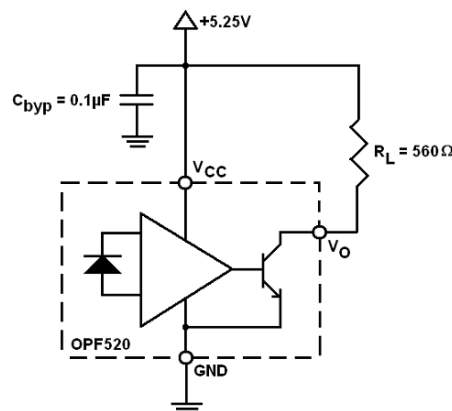

RoHS

OPTEK reserves the right to make changes at any time in order to improve design and to supply the best product possible.

Switching Characteristics

(See Recommended Test Circuit)

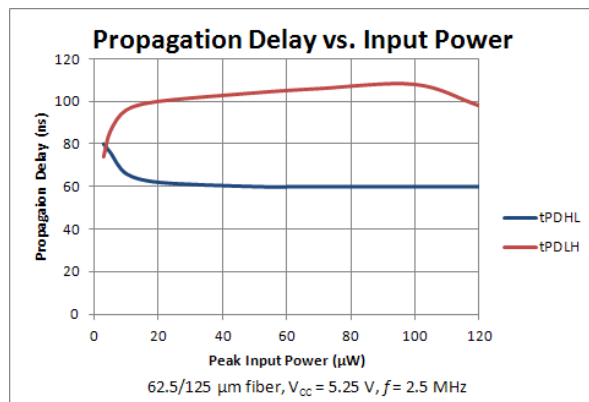
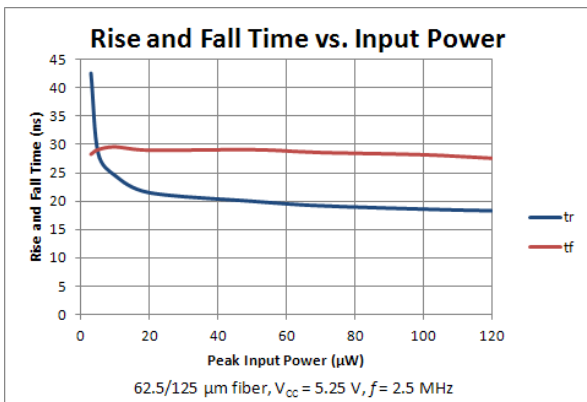
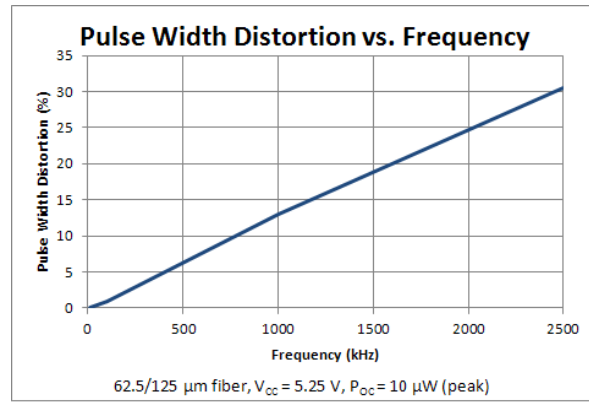
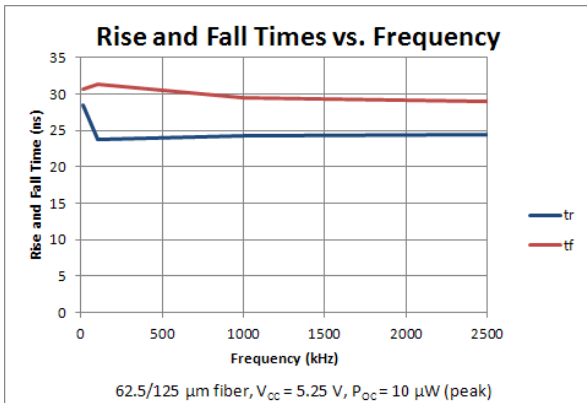
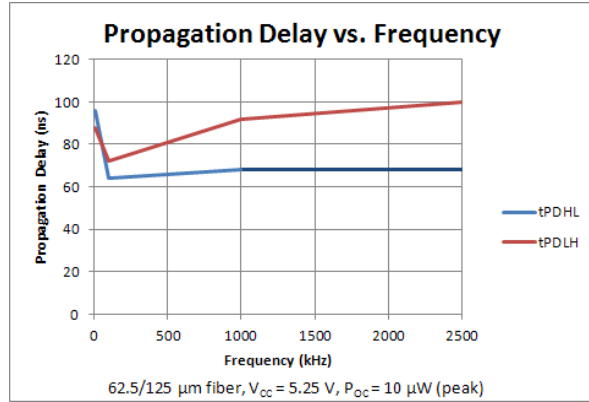
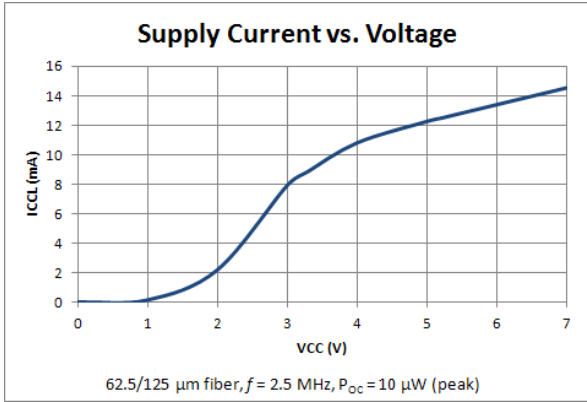

RoHS

OPTEK reserves the right to make changes at any time in order to improve design and to supply the best product possible.

Switching Characteristics
(continued)

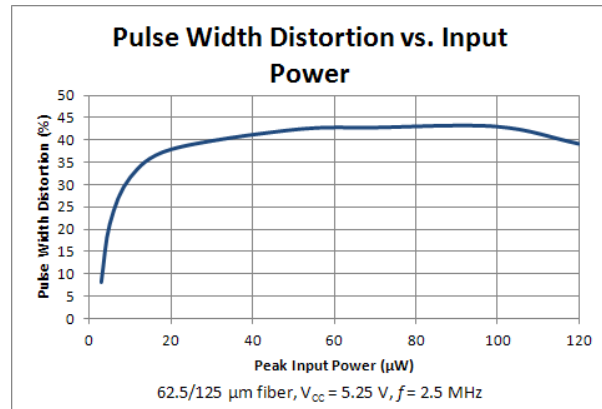
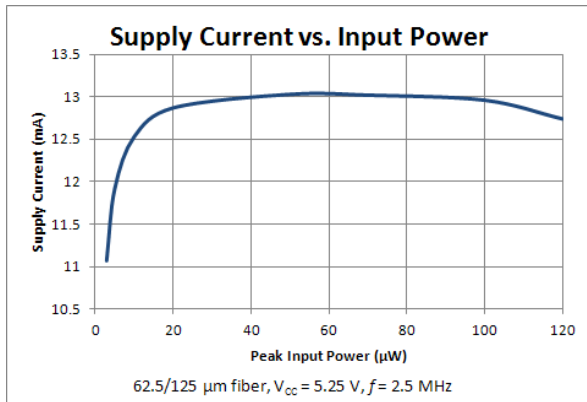

(This space intentionally left blank)



RoHS

OPTEK reserves the right to make changes at any time in order to improve design and to supply the best product possible.

**Typical Waveforms for
Various Input Powers**

(62.5/125 μm fiber, $V_{CC} = 5.25\text{ V}$, $f = 2.5\text{ MHz}$)
(See Recommended Test Circuit)

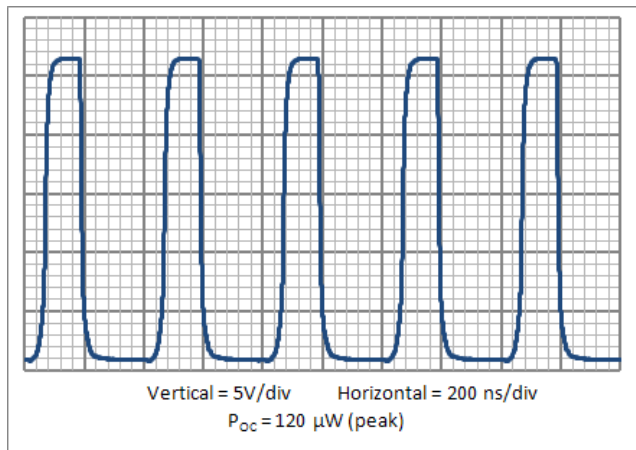
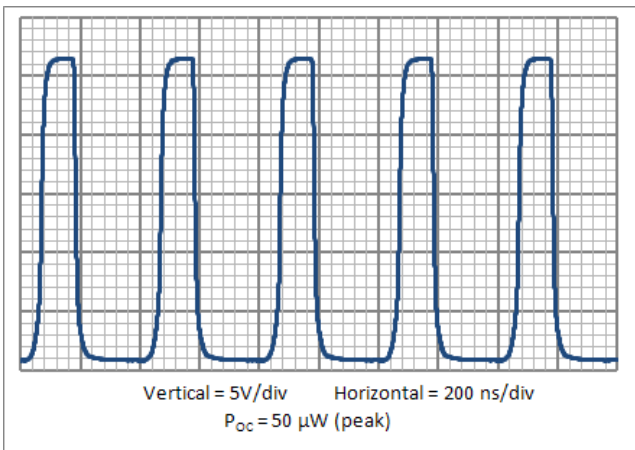
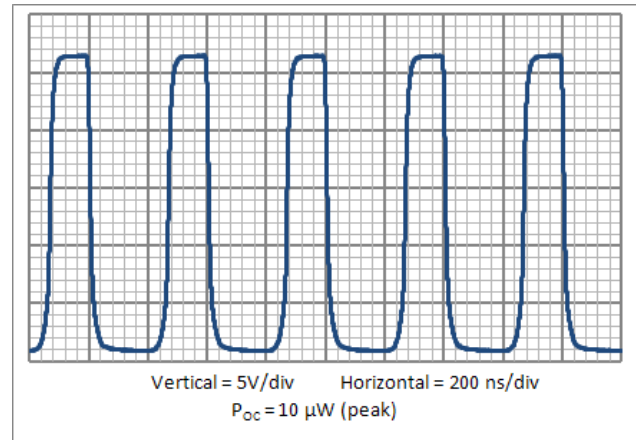
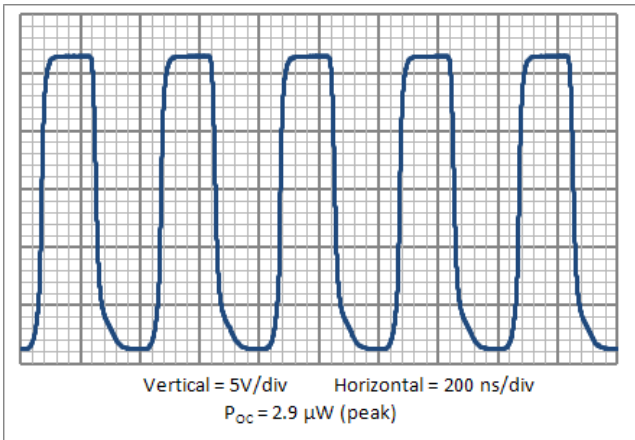

RoHS

OPTEK reserves the right to make changes at any time in order to improve design and to supply the best product possible.

Typical Waveforms for Various Frequencies

(62.5/125 μm fiber, $V_{CC} = 5.25\text{ V}$, $P_{OC} = 10\mu\text{W}$ (peak)
(See Recommended Test Circuit)

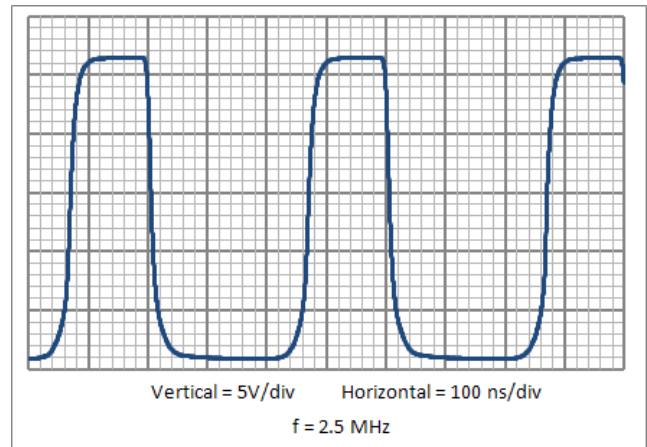
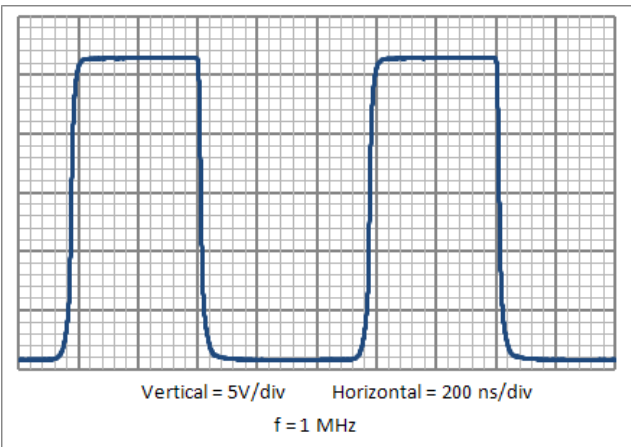
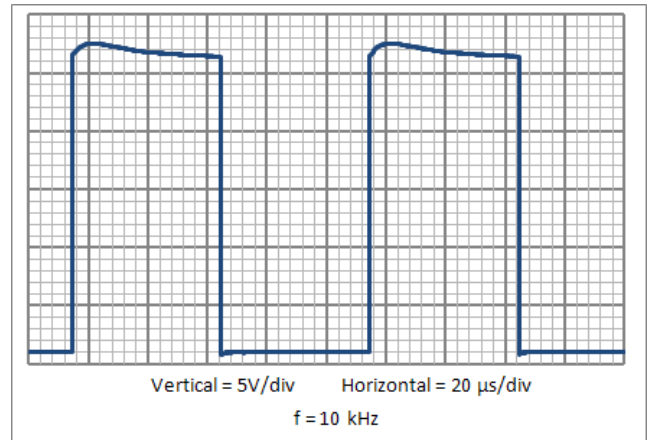
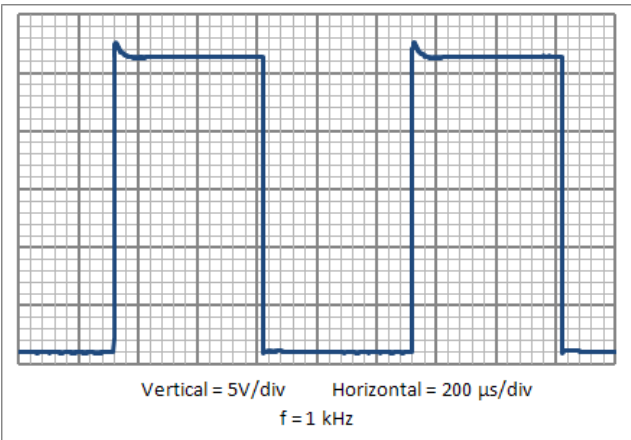

RoHS

OPTEK reserves the right to make changes at any time in order to improve design and to supply the best product possible.

**Typical Waveforms for
Various Fiber Cables and
Input Powers**

($V_{CC} = 5.25\text{ V}$, $f = 2.5\text{ MHz}$)
(See Recommended Test Circuit)

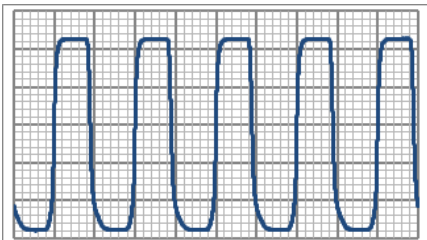

Vertical = 5V/div Horizontal = 200 ns/div
50/125 μm fiber, $P_{OC} = 2.9\ \mu\text{W}$ (peak)

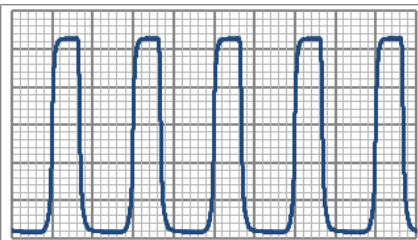

Vertical = 5V/div Horizontal = 200 ns/div
50/125 μm fiber, $P_{OC} = 10\ \mu\text{W}$ (peak)

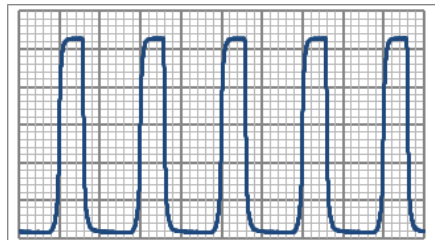

Vertical = 5V/div Horizontal = 200 ns/div
50/125 μm fiber, $P_{OC} = 120\ \mu\text{W}$ (peak)

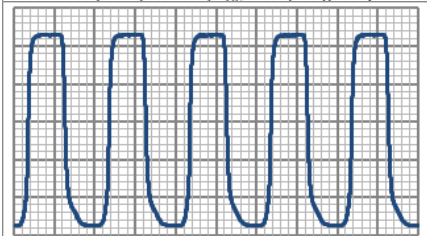

Vertical = 5V/div Horizontal = 200 ns/div
62.5/125 μm fiber, $P_{OC} = 2.9\ \mu\text{W}$ (peak)

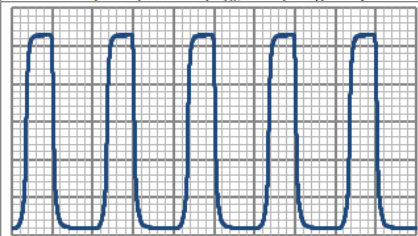

Vertical = 5V/div Horizontal = 200 ns/div
62.5/125 μm fiber, $P_{OC} = 10\ \mu\text{W}$ (peak)

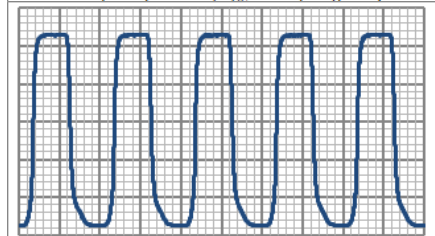

Vertical = 5V/div Horizontal = 200 ns/div
62.5/125 μm fiber, $P_{OC} = 2.9\ \mu\text{W}$ (peak)

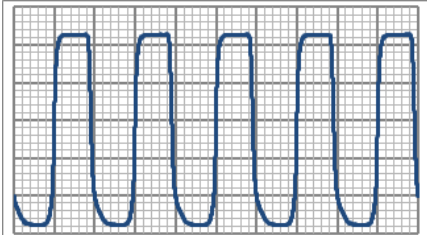

Vertical = 5V/div Horizontal = 200 ns/div
100/140 μm fiber, $P_{OC} = 2.9\ \mu\text{W}$ (peak)

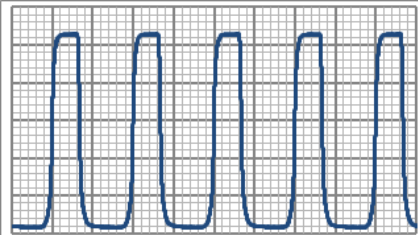

Vertical = 5V/div Horizontal = 200 ns/div
100/140 μm fiber, $P_{OC} = 10\ \mu\text{W}$ (peak)

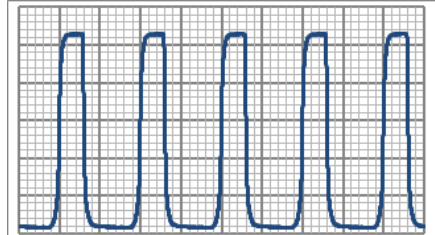

Vertical = 5V/div Horizontal = 200 ns/div
100/140 μm fiber, $P_{OC} = 120\ \mu\text{W}$ (peak)

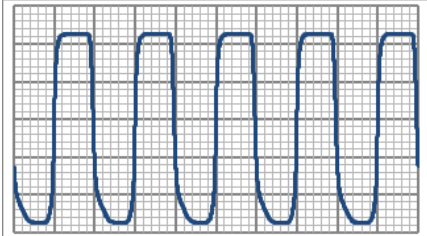

Vertical = 5V/div Horizontal = 200 ns/div
200/230 μm fiber, $P_{OC} = 2.9\ \mu\text{W}$ (peak)

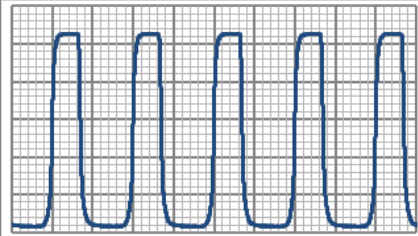

Vertical = 5V/div Horizontal = 200 ns/div
200/230 μm fiber, $P_{OC} = 10\ \mu\text{W}$ (peak)

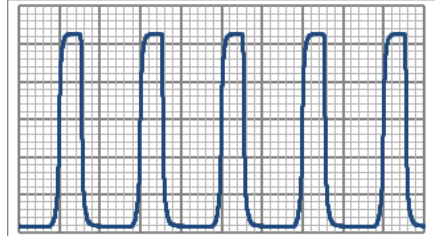

Vertical = 5V/div Horizontal = 200 ns/div
200/230 μm fiber, $P_{OC} = 120\ \mu\text{W}$ (peak)



RoHS

OPTEK reserves the right to make changes at any time in order to improve design and to supply the best product possible.

Mechanical Outline — OPF520

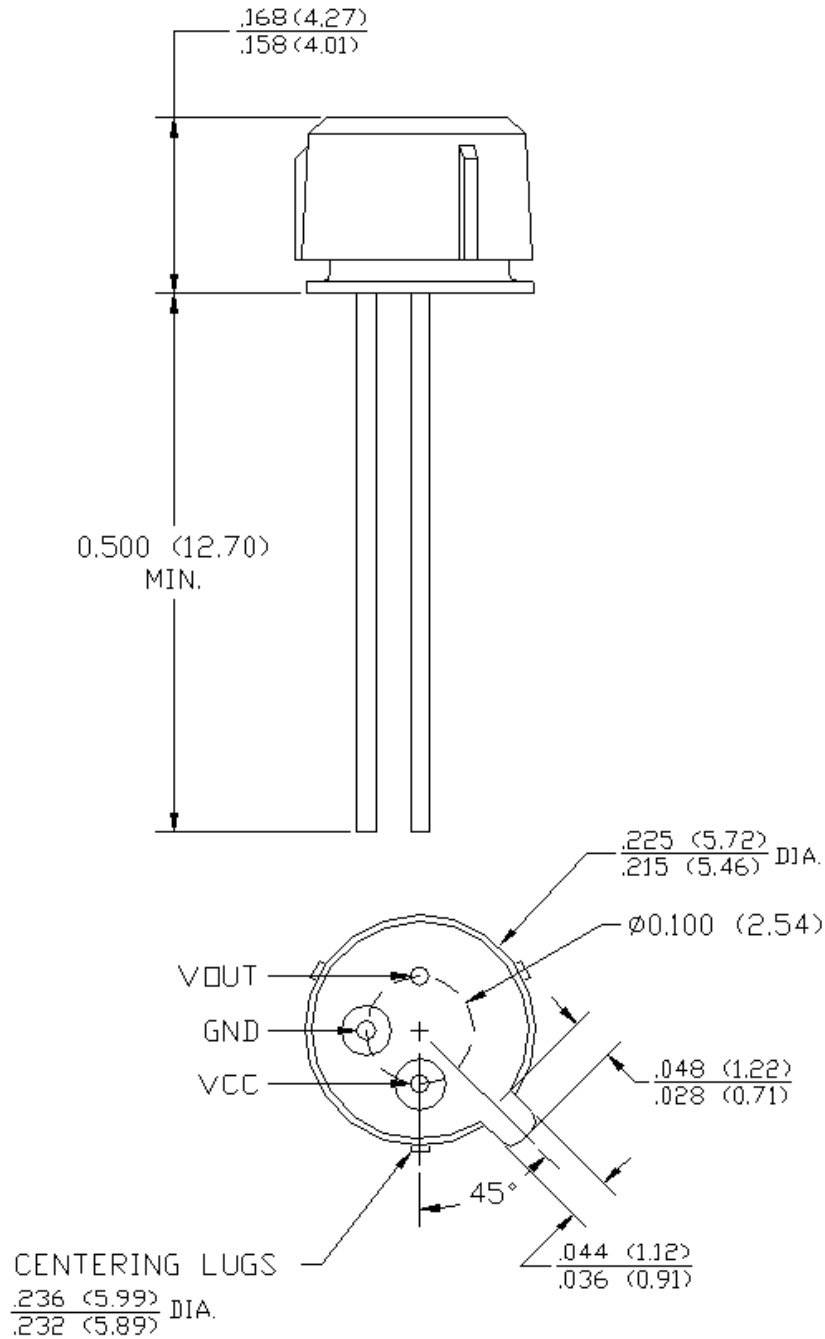

OPTEK reserves the right to make changes at any time in order to improve design and to supply the best product possible.

Mechanical Outline — OPF522

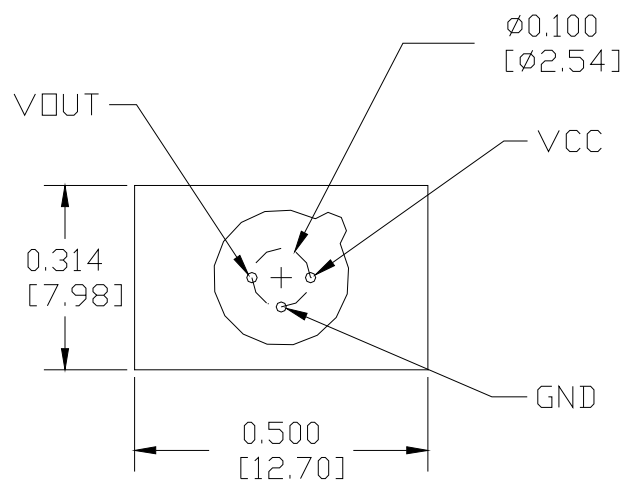
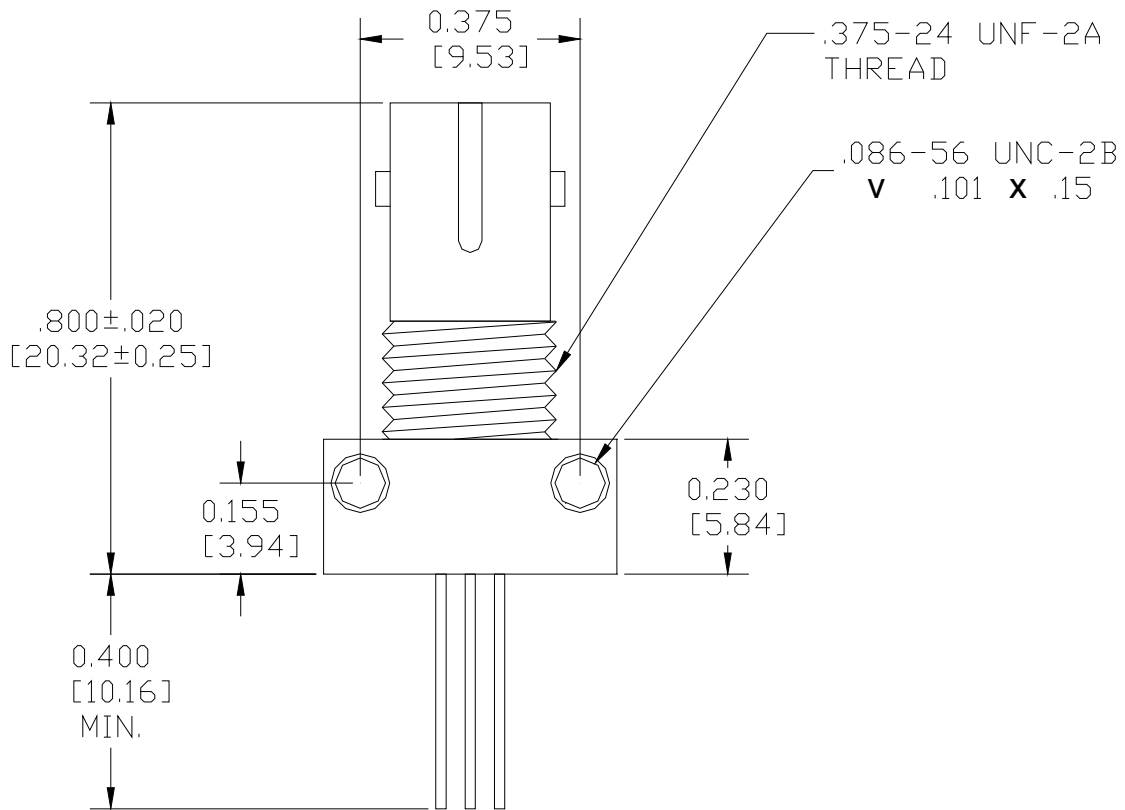

OPTEK reserves the right to make changes at any time in order to improve design and to supply the best product possible.