

ELM834xA 40µA Low power CMOS dual operational amplifier

<http://www.elm-tech.com>

■General description

ELM834xA is a low current consumption-Typ.40µA CMOS dual OP-AMP provided with a wide common mode input voltage range. It has a quasi rail-to-rail input stage and a push-pull rail-to-rail output stage. ELM834xA can operate down to 1.2V. ELM834xA is suitable for portable devices which require low power and a single voltage source.

■Features

- Operation from a single power source
- Low voltage operation : $1.2V \leq V_{dd} \leq 6.0V$
- Low current consumption : Typ.42µA($V_{dd}=3.0V$)
- N-channel depletion differential input
 - : No gm dependence on input operating points
- Common-mode input voltage range
 - : Quasi rail-to-rail input
 - V_{ss} to $V_{dd}-0.3V$ ($V_{dd}=1.5V$)
 - V_{ss} to $V_{dd}-0.1V$ ($V_{dd}=3.0V$)
- Output stage : Push-pull rail-to-rail output
- Unity gain bandwidth : Typ.150kHz($V_{dd} \geq 1.5V$)
- Package : SOT-28, SOP-8, TSSOP-8

■Application

- Battery-operated portable devices
- Micropower signal process
- Low voltage analog circuit

■Maximum absolute ratings

Parameter	Symbol	Limit	Unit
Power supply voltage	V _{dd}	7.0	V
Input voltage	V _{in}	V _{ss} -0.3 to V _{dd} +0.3	V
Output voltage	V _{out}	V _{ss} -0.3 to V _{dd} +0.3	V
Output short circuit		Continuous	Sec.
Power dissipation	P _d	300	mW
Operating temperature	T _{op}	-40 to +85	°C
Storage temperature	T _{stg}	-55 to +125	°C

■Selection guide

ELM834xA-x

Symbol		
a	Package	B: SOT-28 D: SOP-8 E: TSSOP-8
b	Product version	A
c	Taping direction	S: Refer to PKG file N: Refer to PKG file

ELM834 x A - x
 ↑ ↑ ↑
 a b c

ELM834xA 40μA Low power CMOS dual operational amplifier

<http://www.elm-tech.com>

■ Pin configuration

SOT-28(TOP VIEW)

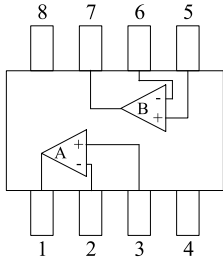

SOP-8(TOP VIEW)

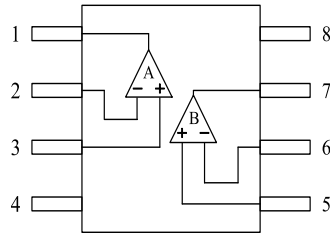

TSSOP-8(TOP VIEW)

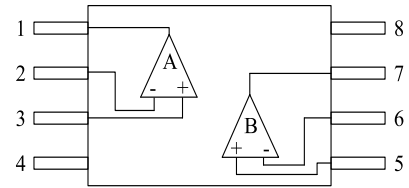

Pin No.	Pin name	Pin No.	Pin name
1	OUTA	5	IN+B
2	IN-A	6	IN-B
3	IN+A	7	OUTB
4	VSS	8	VDD

■ Standard circuit

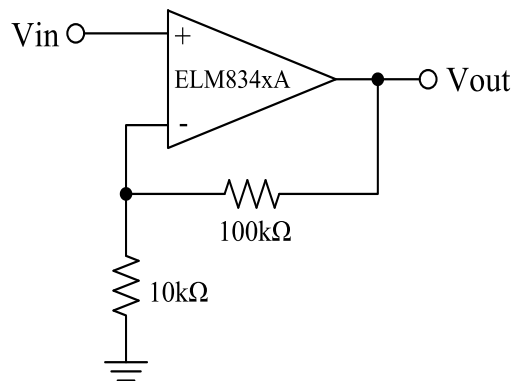

■ Marking

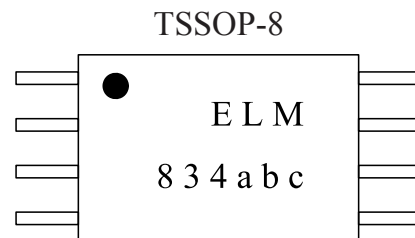
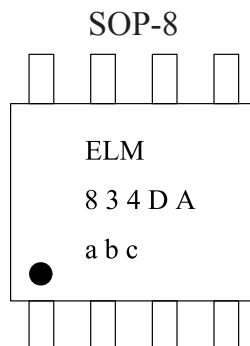
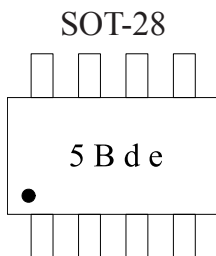

Symbol	Mark	Content
a	0 to 9	Last numeral of A.D.
b	A to M (excepted I.)	Assembly month
c	0 to 9	Lot No.
d	0 to 9 and A to Z (I, O, X excepted.)	
e		

ELM834xA 40 μ A Low power CMOS dual operational amplifier

<http://www.elm-tech.com>

■ Electrical characteristics

V_{ss}=0V, Top=-40~+85°C

Parameter	Symbol	Condition	Min.	Typ.	Max.	Unit
Operating voltage	V _{dd}		1.2		6.0	V

V_{dd}=1.5V

V_{ss}=0V, Top=25°C

Parameter	Symbol	Condition	Min.	Typ.	Max.	Unit
Input offset voltage	V _{io}	V _{cm} =V _{dd} /2, Unity gain follower			±6	mV
Input bias current	I _{ib}				1.0	nA
Common-mode input voltage range	V _{cmr}	For CMRR \geq 50dB	0.00		1.20	V
Maximum output voltage swing	V _{outsh}	V _{id} =100mV, R _L =10k Ω to V _{ss}	1.40			V
Minimum output voltage swing	V _{outsl}	V _{id} =100mV, R _L =10k Ω to V _{dd}			0.10	V
Source current	I _{source}	V _{out} =1.2V, V _{id} =100mV	0.4	1.0		mA
Sink current	I _{sink}	V _{out} =0.3V, V _{id} =100mV	1.0	2.5		mA
Large-signal voltage gain	A _{vd}	R _L =10k Ω to V _{ss} , V _{cm} =0.75V		100		dB
Common-mode rejection ratio	CMRR	R _L =10k Ω to V _{ss} , V _{cm} =0.75V		80		dB
Supply voltage rejection ratio	PSRR	R _L =10k Ω to V _{ss} , V _{cm} =0.75V		85		dB
Current consumption	I _{ss}	V _{cm} =V _{dd} /2, Unity gain follower		40	80	μ A
Short current	I _{shortp}	V _{out} to V _{ss} shrot, V _{id} =100mV		1.4		mA
	I _{shortn}	V _{out} to V _{dd} shrot, V _{id} =100mV		4.0		mA
Unity gain bandwidth	GBW			150		kHz
Slew rate	SR	R _L =100k Ω , C _L =20pF	80	190		mV/ μ s

V_{dd}=3.0V

V_{ss}=0V, Top=25°C

Parameter	Symbol	Condition	Min.	Typ.	Max.	Unit
Input offset voltage	V _{io}	V _{cm} =V _{dd} /2, Unity gain follower			±6	mV
Input bias current	I _{ib}				1.0	nA
Common-mode input voltage range	V _{cmr}	For CMRR \geq 50dB	0.00		2.90	V
Maximum output voltage swing	V _{outsh}	V _{id} =100mV, R _L =10k Ω to V _{ss}	2.90			V
Minimum output voltage swing	V _{outsl}	V _{id} =100mV, R _L =10k Ω to V _{dd}			0.10	V
Source current	I _{source}	V _{out} =2.7V, V _{id} =100mV	1.5	4.0		mA
Sink current	I _{sink}	V _{out} =0.3V, V _{id} =100mV	3.0	7.5		mA
Large-signal voltage gain	A _{vd}	R _L =10k Ω to V _{ss} , V _{cm} =1.5V		105		dB
Common-mode rejection ratio	CMRR	R _L =10k Ω to V _{ss} , V _{cm} =1.5V		85		dB
Supply voltage rejection ratio	PSRR	R _L =10k Ω to V _{ss} , V _{cm} =1.5V		100		dB
Current consumption	I _{ss}	V _{cm} =V _{dd} /2, Unity gain follower		42	90	μ A
Short current	I _{shortp}	V _{out} to V _{ss} shrot, V _{id} =100mV		14		mA
	I _{shortn}	V _{out} to V _{dd} shrot, V _{id} =100mV		25		mA
Unity gain bandwidth	GBW			150		kHz
Slew rate	SR	R _L =100k Ω , C _L =20pF	80	200		mV/ μ s

ELM834xA 40 μ A Low power CMOS dual operational amplifier

<http://www.elm-tech.com>

■Note

1) Common mode input voltage range

ELM834xA common mode input voltage range is fixed under the condition of $CMRR \geq 50\text{dB}$; ELM834xA is able to accept the input above its specification if the degradation of $CMRR$ is not considered. Even if the input voltage exceeds either positive or negative power voltage, troubles such as reverse of output will not occur.

As maximum absolute rating, the input voltage is possible within $(V_{ss}-0.3)\text{V}$ to $(V_{dd}+0.3)\text{V}$.

2) Operation from single power source

ELM834xA is designed to be most suitable for single power source, ELM834xA is able to share power supply with logic circuit one. Meanwhile, ELM834xA can also operate from double power sources. To protect power supplies of ELM834xA and logic circuit from noise, please separate wire from power supply and use decoupling (bypass) capacitor. Using the capacitor can improve PSRR characteristics, especially on 10kHz to 100kHz or more.

3) Feedback

When OP-AMP circuit is used with feedback resistor, oscillation may happen in the circuit with loop-gain like unity gain follower.

a) When large feedback resistance is used, the phase margin is decreased by its combination with the parasitic capacitance of the input part of OP-AMP. In this situation, please connect small capacitor in parallel with feedback resistor as shown in fig-1.

b) For capacitive load, external resistor in series connection will be effective as shown in fig-2.

($R_L = 300$ to 500Ω)

c) Being used as an unity gain follow, ELM834xA is able to drive capacitive load of 100pF directly without oscillation.

a) fig-1

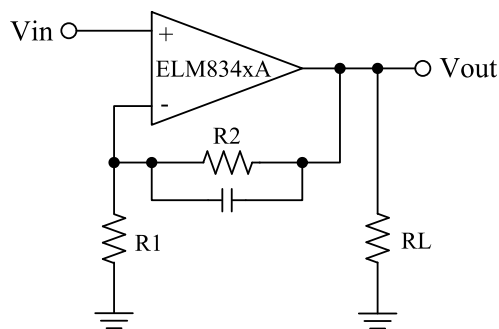

b) fig-2

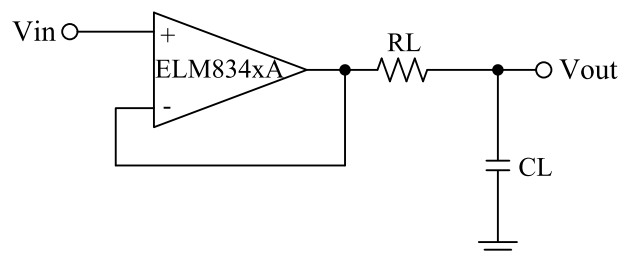

4) Unused Amplifier

Two amplifiers will consume power even if only one amplifier is used.

In order to minimize power consumption by the unused amplifier, ELM recommends to connect this amplifier as voltage follower circuit and the input terminal (IN+) to V_{dd} .

ELM834xA 40 μ A Low power CMOS dual operational amplifier

<http://www.elm-tech.com>

■ Typical characteristics

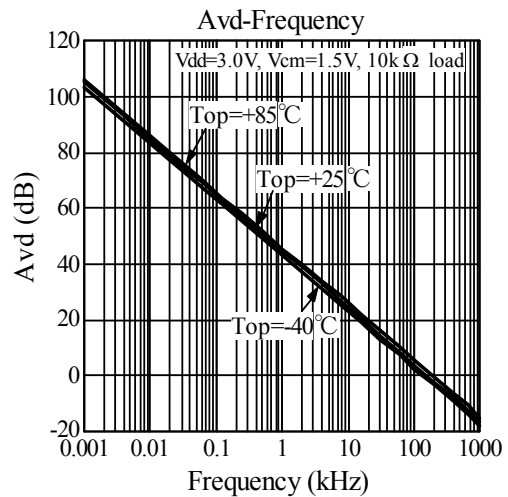
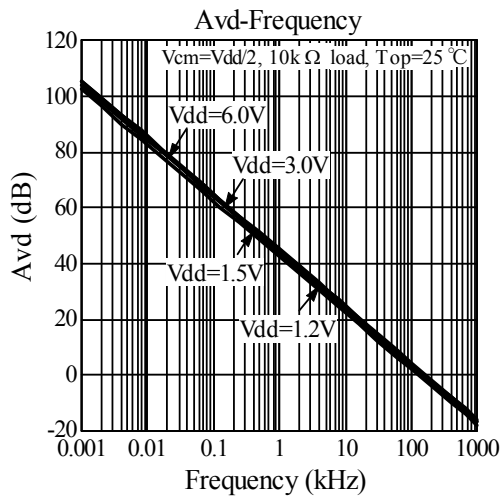
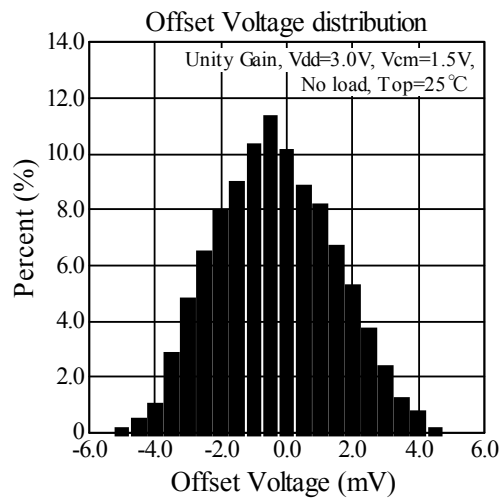
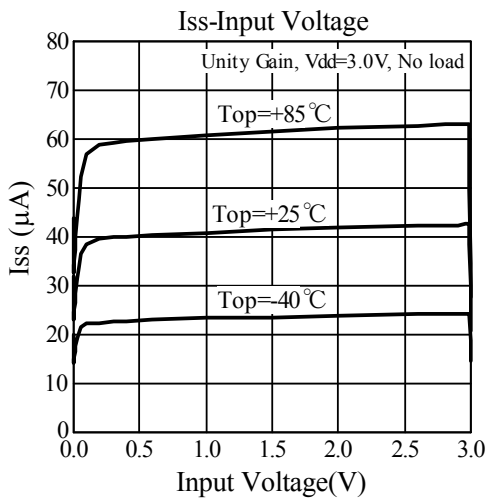
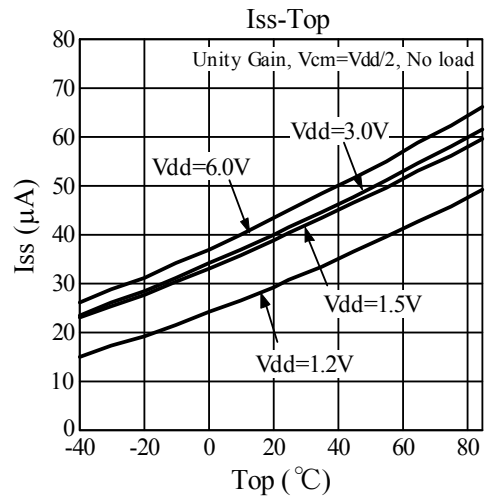
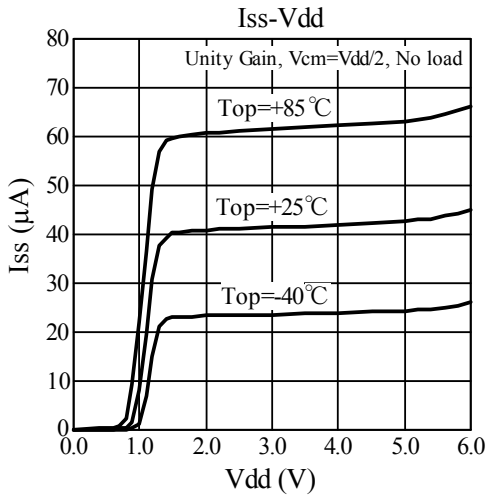

ELM834xA 40 μ A Low power CMOS dual operational amplifier

<http://www.elm-tech.com>

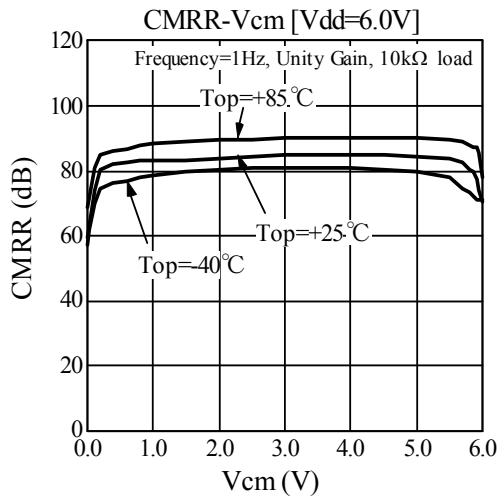
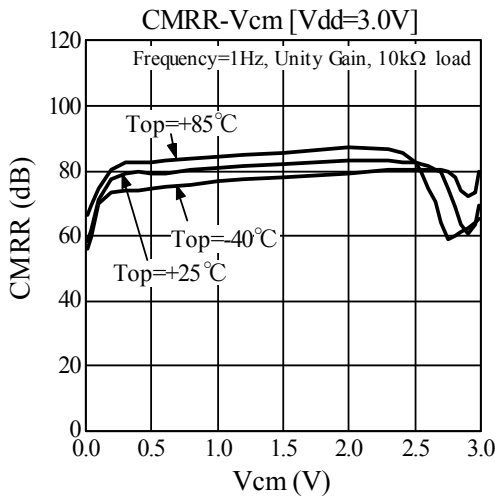
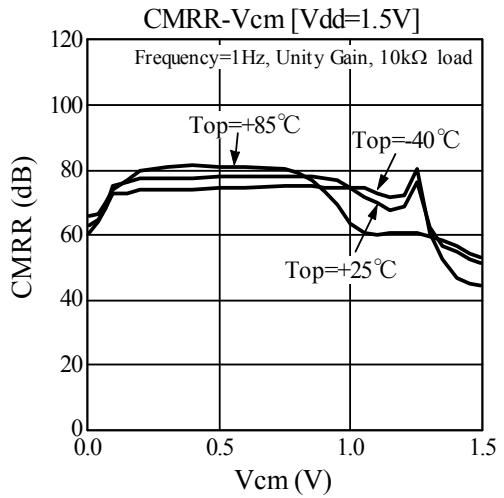
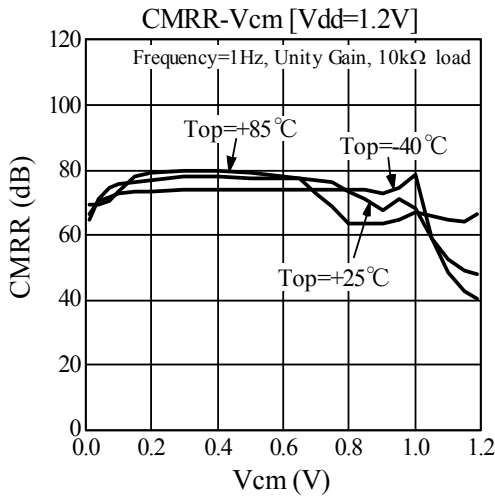
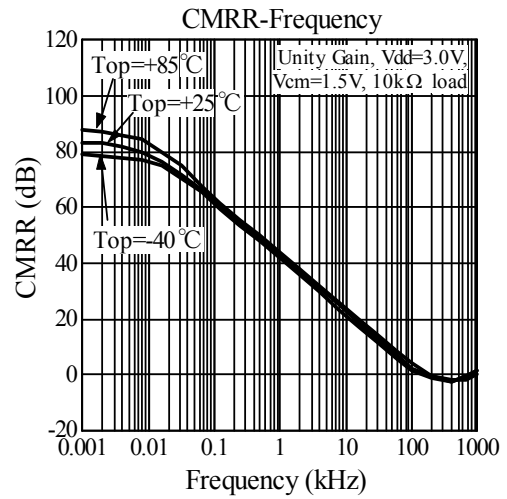
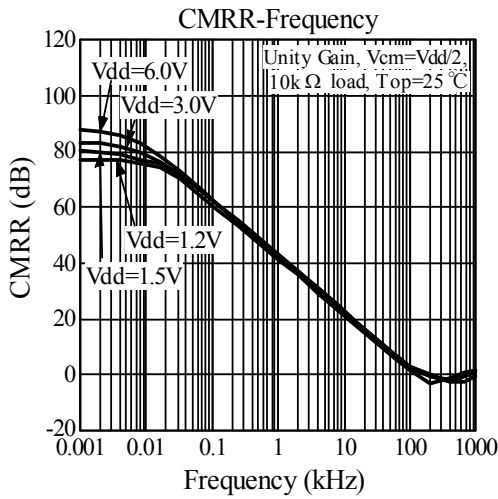

ELM834xA 40 μ A Low power CMOS dual operational amplifier

<http://www.elm-tech.com>

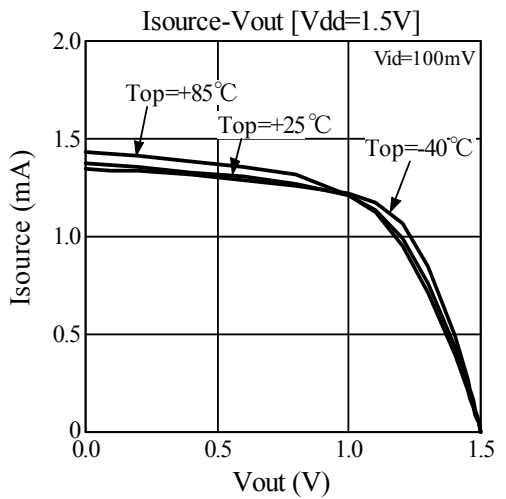
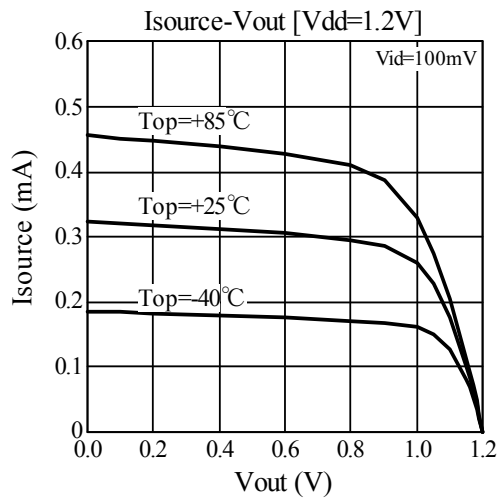
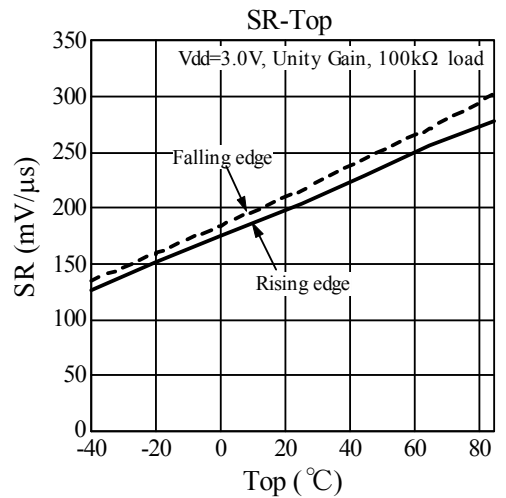
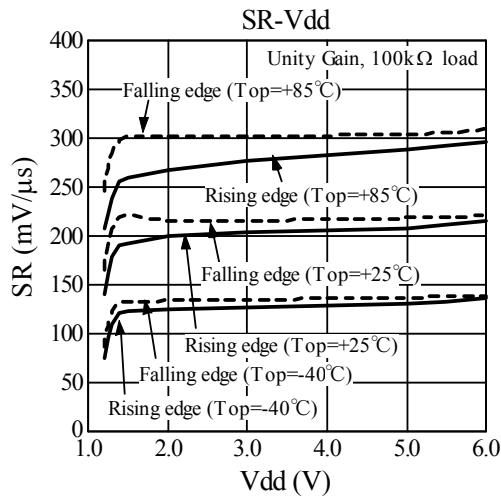
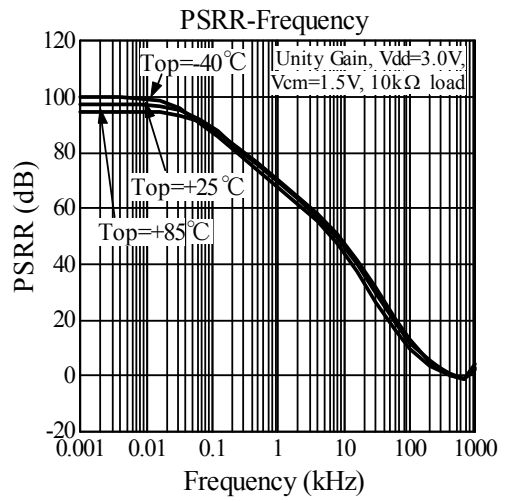
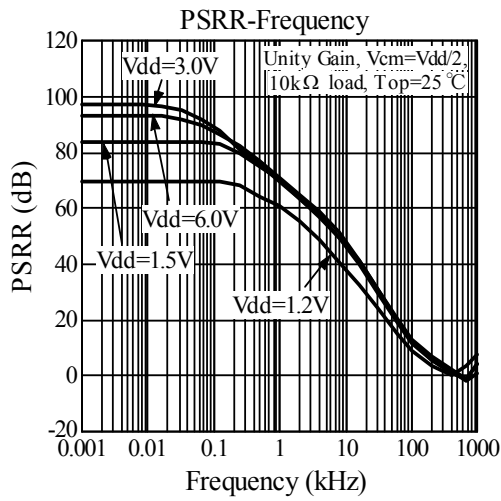

ELM834xA 40 μ A Low power CMOS dual operational amplifier

<http://www.elm-tech.com>

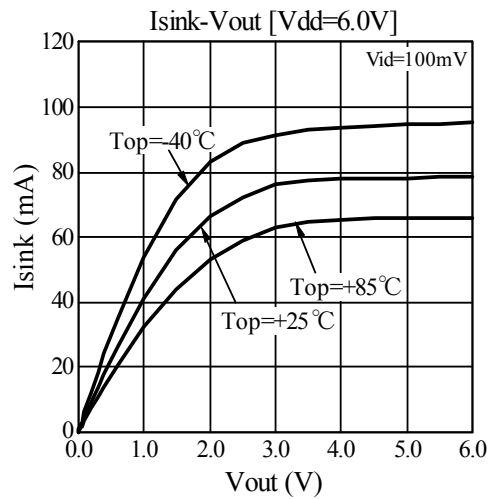
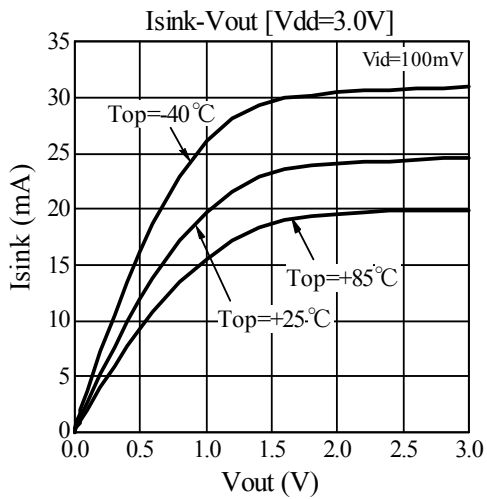
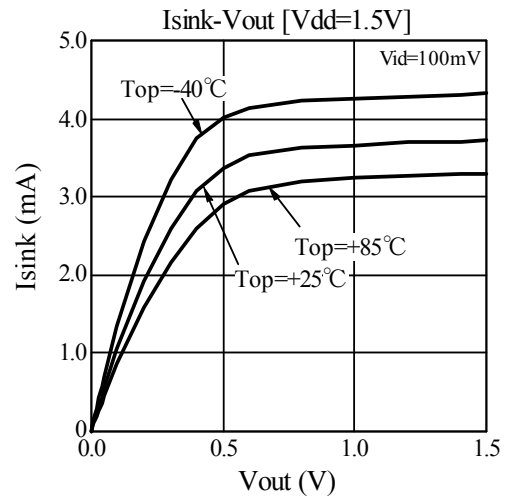
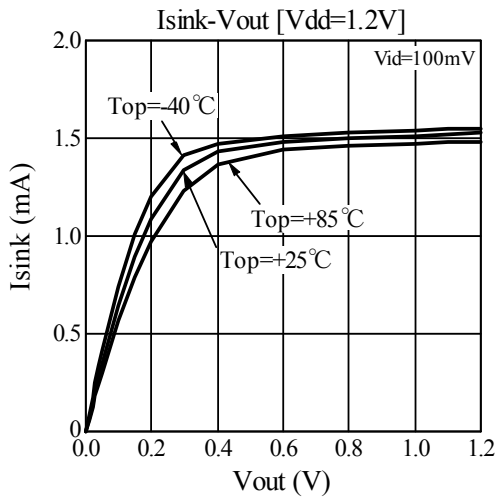
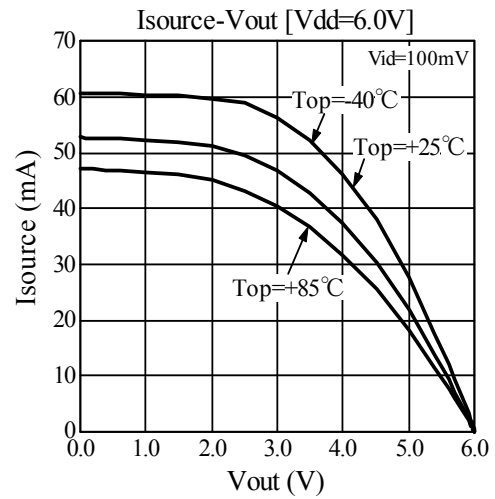
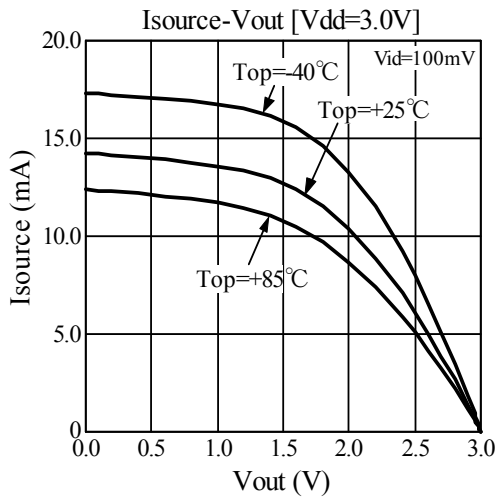

ELM834xA 40 μ A Low power CMOS dual operational amplifier

<http://www.elm-tech.com>

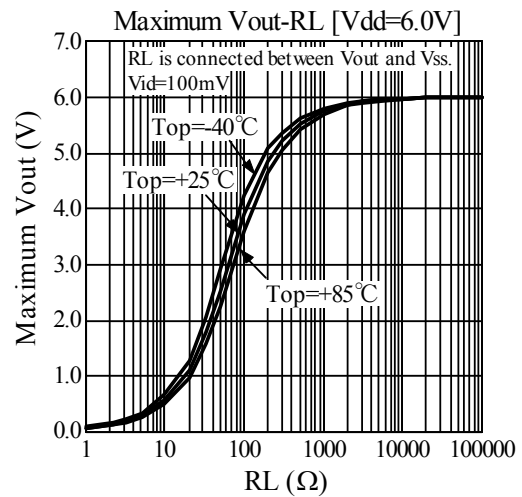
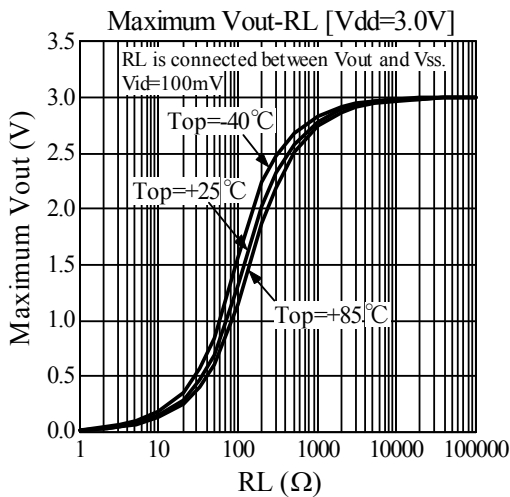
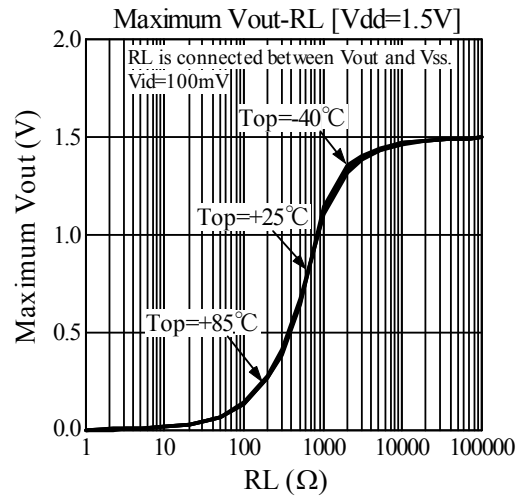
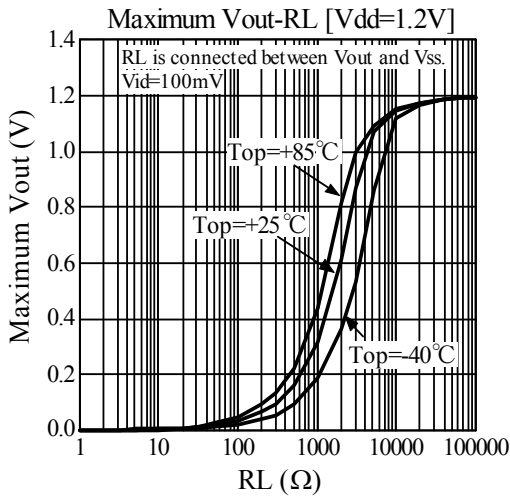
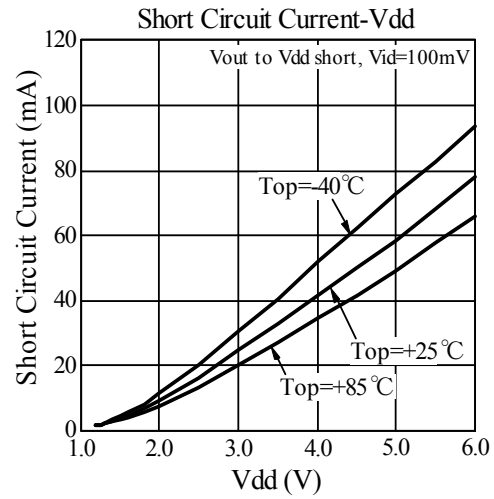
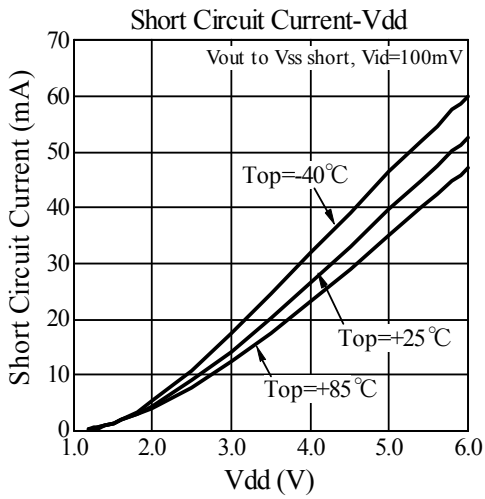

ELM834xA 40 μ A Low power CMOS dual operational amplifier

<http://www.elm-tech.com>

