

MTR (50) Single and Dual DC-DC Converters

28 (16-50) VOLT INPUT – 30 WATT

FEATURES

- Input voltage range 16 to 50 volts
- Transient protection up to 80 volts per MIL-STD-704A
- Operating temperature -55°C to +125°C
- Fully isolated, magnetic feedback
- Fixed high frequency switching
- Inhibit and synchronization function
- Indefinite short circuit and overload protection



LEGACY MTR (40):
16 - 40 Vin, 50 V transient / 50 ms.
Datasheet at www.interpoint.com/mtr40

MODELS	
OUTPUT VOLTAGE (V)	
SINGLE	DUAL
3.3	±5
5	±12
8.5	±15
12	
15	

DESCRIPTION

The Interpoint® MTR Series™ of dc-dc converters offers up to 30 watts of output power from single or dual output configurations. MTR (50) models have a wide input voltage range of 16 to 50 volts. Transient protection of up to 80 volts input meets the transient requirements of MIL-STD-704A. The converters operate over the full military temperature range with up to 81% efficiency. MTR converters are packaged in hermetically sealed metal cases, making them ideal for use in military, aerospace and other high reliability applications. The converters are offered with standard screening, “ES” screening, or fully compliant to “883” MIL-PRF-38534 Class H screening. See Table 9 on page 19 and Table 10 on page 20. Standard microcircuit drawings (SMD) are available refer to Table 3 on page 6.

COVER MARKING

The cover marking for the MTR 50 has “MTR (50) DC-DC CONVERTER” below the model number. Refer to Figure 8 on page 6.

CONVERTER DESIGN

The MTR converters are constant frequency, pulse-width modulated switching regulators which use a quasi-square wave, single ended, forward converter design. Tight load regulation is maintained via wide bandwidth magnetic feedback and, on single output models, through use of remote sense. On dual output models, the positive output is independently regulated and the negative output is cross regulated through the use of tightly coupled magnetics.

Indefinite short circuit protection and overload protection are provided by a constant current-limit feature. This protective system senses current in the converter’s secondary stage and limits it to approximately 140% of the maximum rated output current.

MTR converters are provided with internal filtering capacitors that help reduce the need for external components in normal operation. Use our FMCE-0328™, FMCE-0528™ or FMCE-0828™ EMI filter to meet the requirements of MIL-STD-461C CE03 and CS01 and/or MIL-STD-461D, E and F CE102 and CS101 levels of conducted emissions.

MTR (50) Single and Dual DC-DC Converters

28 (16-50) VOLT INPUT – 30 WATT

SYNCHRONIZATION

Synchronizing the converter with the system clock allows the designer to confine switching noise to clock transitions, minimizing interference and reducing the need for filtering. In sync mode, the converter will run at any frequency between 500 kHz and 675 kHz. The sync control operates with a duty cycle between 40% and 60%. The sync pin must be connected to input common pin when not in use.

DYNAMIC RESPONSE

The MTR Series feed-forward compensation system provides excellent dynamic response and noise rejection. Audio rejection is typically 40 dB. The minimum to maximum step line transition response is typically less than 4%.

INHIBIT FUNCTION

MTR Series converters provide an inhibit terminal that can be used to disable internal switching, resulting in no output voltage and very low quiescent input current. The converter is inhibited when the inhibit pin is pulled below 0.8 volts and enabled when its inhibit pin is left floating. An external inhibit interface should be capable of pulling the converter's inhibit pin below 0.8 volts while sinking the maximum inhibit current and also allowing the inhibit pin to float high to enable the converter. A voltage should not be applied to the inhibit pin. The open circuit voltage present on the inhibit pin is 9 to 11 volts

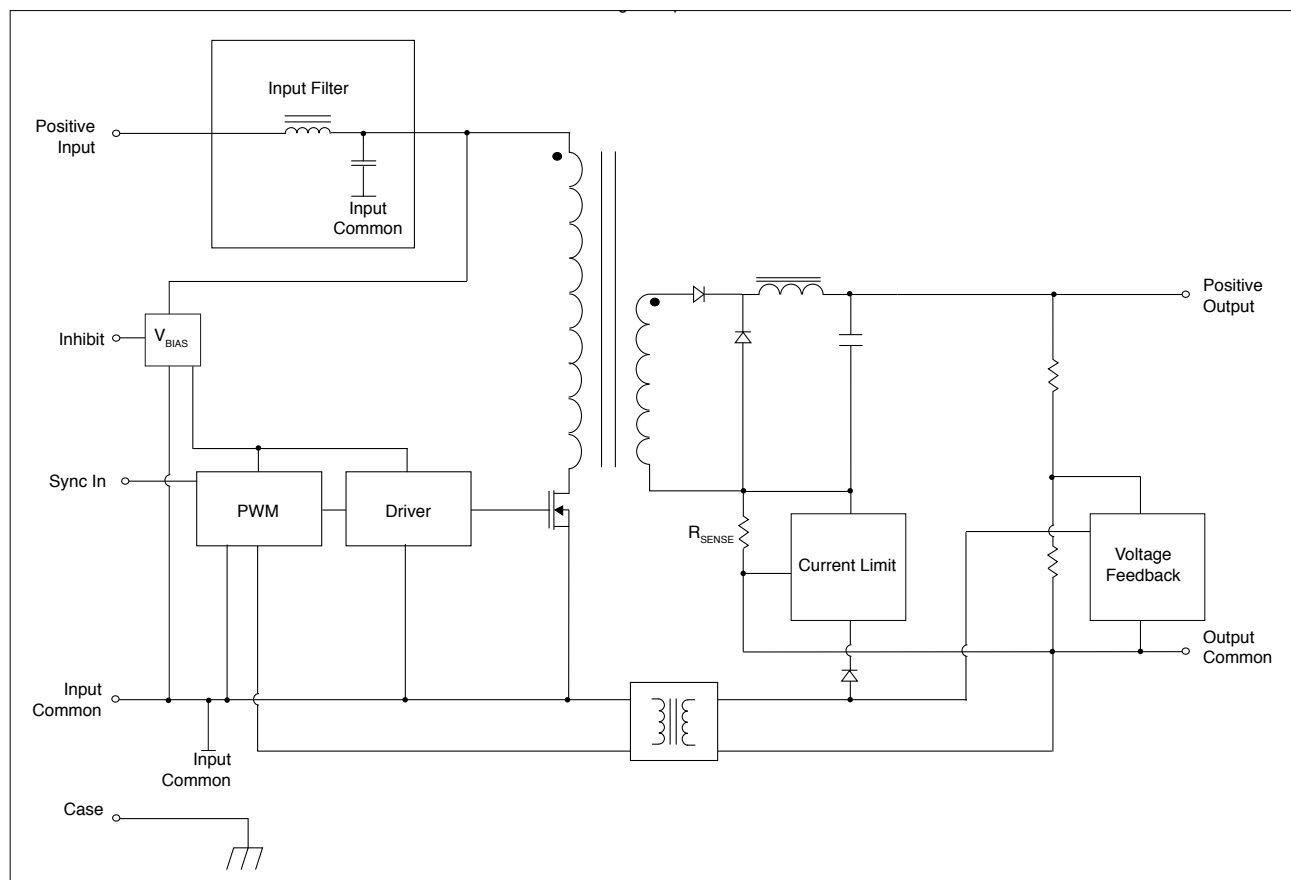

FIGURE 1: MTR SINGLE BLOCK DIAGRAM

MTR (50) Single and Dual DC-DC Converters

28 (16-50) VOLT INPUT – 30 WATT

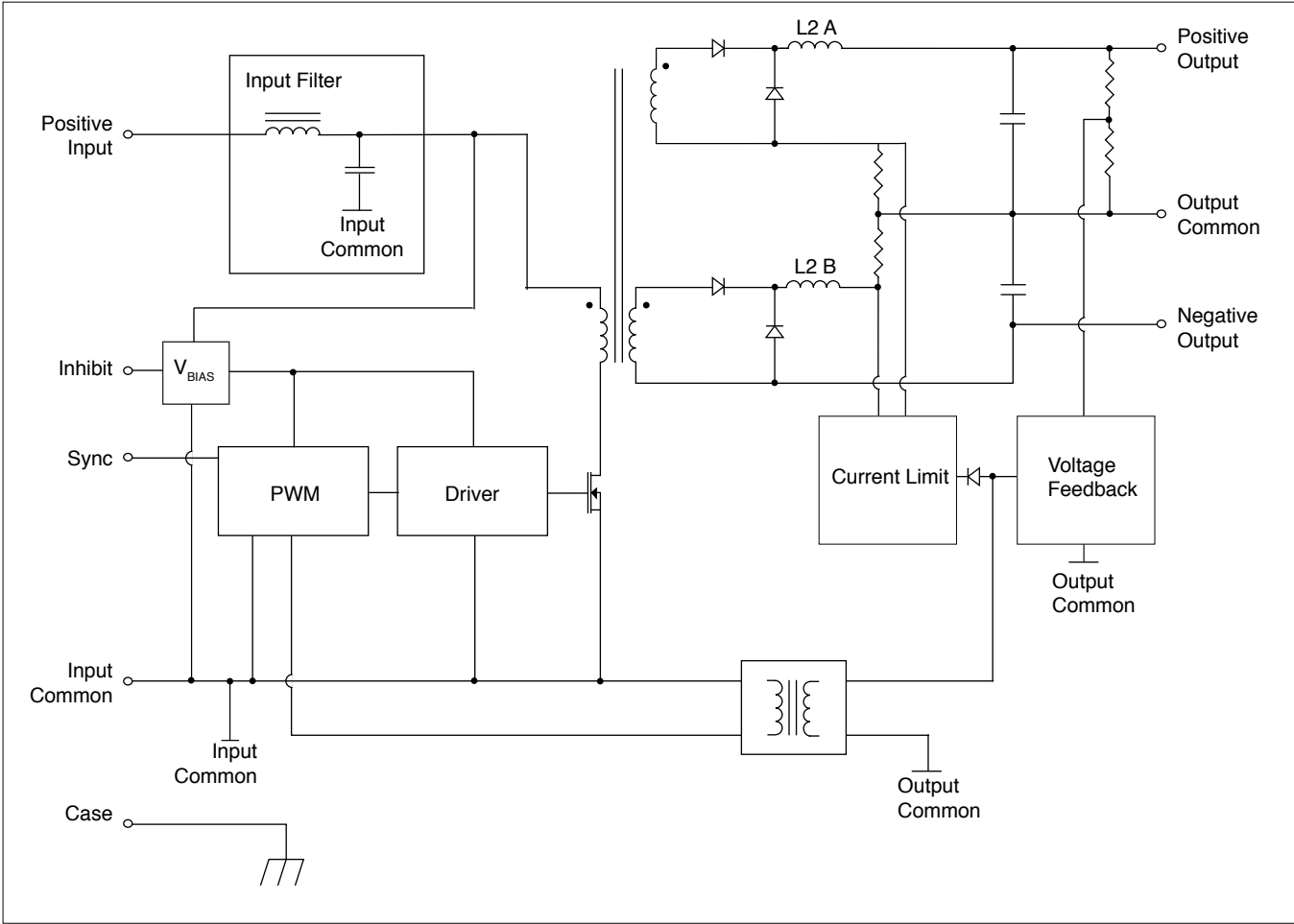

FIGURE 2: MTR DUAL BLOCK DIAGRAM

MTR (50) Single and Dual DC-DC Converters

28 (16-50) VOLT INPUT – 30 WATT

TRIM AND REMOTE SENSE (AVAILABLE ON SINGLE OUTPUT MODELS ONLY)

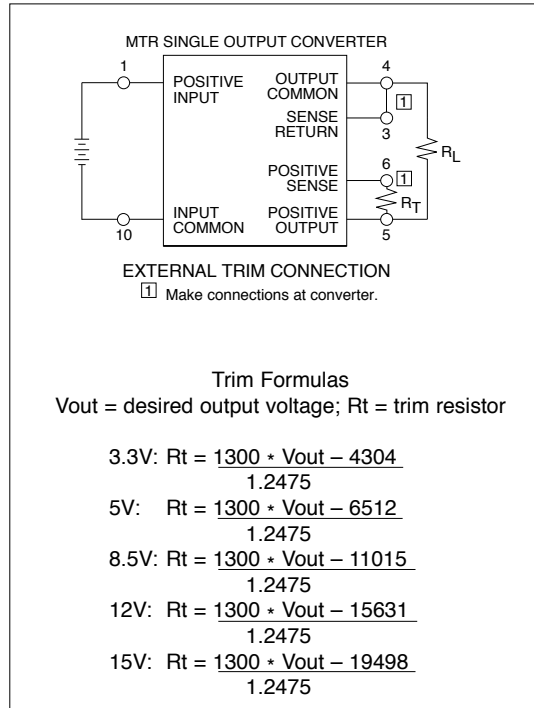

FIGURE 3: TRIM CONNECTION 1, 2, 3

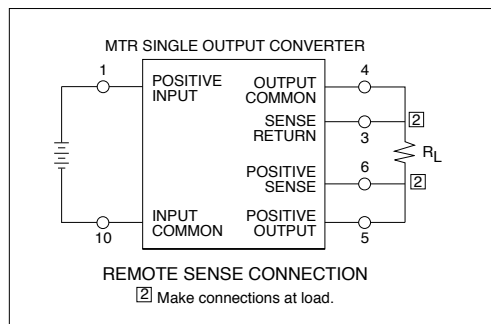

FIGURE 4: REMOTE SENSE CONNECTION 4

Notes for Remote Sense and Trim

1. When trimming output voltage and/or remote sensing, the total output voltage increase must be less than 0.6 volts at the converters pins. Do not exceed the maximum power.
2. If neither voltage trim nor remote sense will be used, connect pin 3 to pin 4 and pin 5 to pin 6.
3. CAUTION: The converter will be permanently damaged if the remote sense (pin 6) is shorted to ground. Damage may also result if the output common or positive output is disconnected from the load when the remote sense leads are connected to the load.
4. When using remote sense for voltage compensation or when using remote sense for trim, the output will drift over temperature. Contact Applications Engineering for more information at powerapps@crane-eg.com

MTR (50) Single and Dual DC-DC Converters

28 (16-50) VOLT INPUT – 30 WATT

PIN OUT		
Pin	Single Output	Dual Output
1	Positive Input	Positive Input
2	Inhibit	Inhibit
3	Sense Return	Positive Output
4	Output Common	Output Common
5	Positive Output	Negative Output
6	Positive Sense	Case Ground
7	Case Ground	Case Ground
8	Case Ground	Case Ground
9	Sync	Sync
10	Input Common	Input Common

TABLE 1: PIN OUT

PINS NOT IN USE	
Inhibit	Leave unconnected
Sync In	Connect to input common
Sense Lines	Must be connected to appropriate outputs

TABLE 2: PINS NOT IN USE

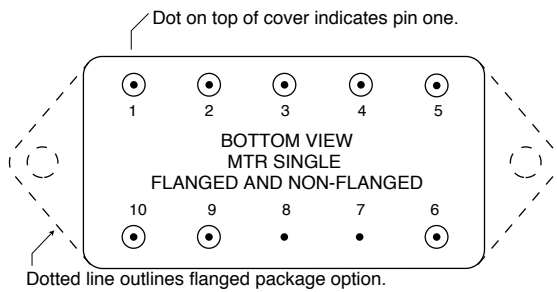

For dimensions see Figure 30 on page 17 and Figure 31 on page 18.

FIGURE 5: PIN OUT SINGLE OUTPUT MODELS

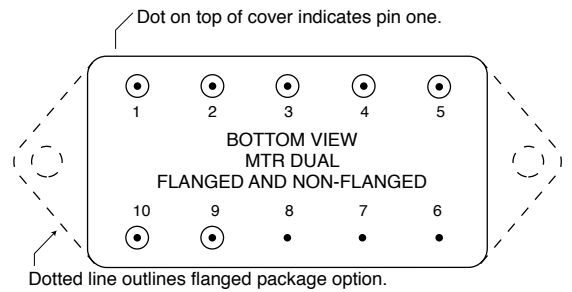

For dimensions see cases Figure 30 on page 17 and Figure 31 on page 18.

FIGURE 6: PIN OUT DUAL OUTPUT MODELS

MTR (50) Single and Dual DC-DC Converters

28 (16-50) VOLT INPUT – 30 WATT

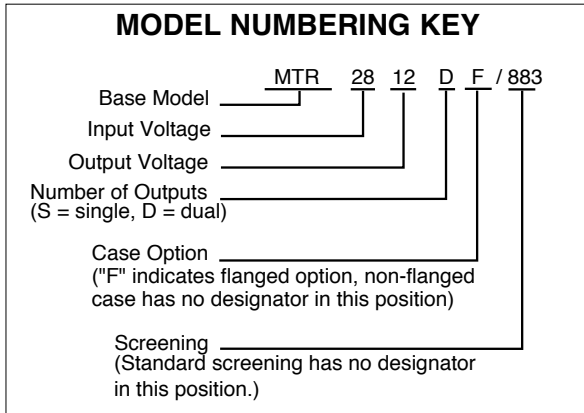

FIGURE 7: MODEL NUMBERING KEY

SMD NUMBERS	
STANDARD MICROCIRCUIT DRAWING (SMD)	MTR SIMILAR PART
5962-0150103HXC	MTR283R3S/883
5962-9306803HXC	MTR2805S/883
5962-9306903HXC	MTR2812S/883
5962-9307003HXC	MTR2815S/883
5962-9320503HXC	MTR2805D/883
5962-9307103HXC	MTR2812D/883
5962-9307203HXC	MTR2815D/883

To indicate the flanged case option change the "X" to "Z" in the SMD number. The SMD number shown is for Class H screening, non-flanged. For exact specifications for an SMD product, refer to the SMD drawing. SMDs can be downloaded from <http://www.landandmaritime.dla.mil/programs/smcr>

TABLE 3: SMD NUMBER CROSS REFERENCE

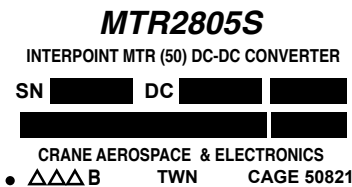

FIGURE 8: COVER MARKING FOR MTR (50) - 50 VIN

MODEL NUMBER OPTIONS					
TO DETERMINE THE MODEL NUMBER ENTER ONE OPTION FROM EACH CATEGORY IN THE FORM BELOW.					
CATEGORY	Base Model and Input Voltage	Output Voltage ¹	Number of Outputs ²	Case Options ³	Screening ⁴
OPTIONS	MTR28	3R3, 05, 8R5, 12, 15	S	(non-flanged, leave blank)	(standard, leave blank)
		05, 12, 15	D	F (flanged)	ES 883
FILL IN FOR MODEL #	MTR28	_____	_____	_____	/ _____

Notes

- Output Voltage: An R indicates a decimal point. 3R3 is 3.3 volts out. The values of 3.3 and 8.5 volts are only available in single output models.
- Number of Outputs: S is a single output and D is a dual output.
- Case Options: For the standard case, Figure 30 on page 17, leave the case option blank. For the flanged case option, Figure 31 on page 18, insert the letter F in the Case Option position.
- Screening: For standard screening leave the screening option blank. For other screening options, insert the desired screening level. For more information see Table 9 on page 19 and Table 10 on page 20.

TABLE 4: MODEL NUMBER OPTIONS

MTR (50) Single and Dual DC-DC Converters

28 (16-50) VOLT INPUT – 30 WATT

TABLE 5: OPERATING CONDITIONS, ALL MODELS: 25°C T_C, 28 V_{IN}, 100% LOAD, UNLESS OTHERWISE SPECIFIED.

PARAMETER	CONDITIONS	ALL MODELS			UNITS
		MIN	TYP	MAX	
LEAD SOLDERING TEMPERATURE ¹	10 SECONDS MAX.	—	—	300	°C
STORAGE TEMPERATURE ¹		-65	—	+150	°C
CASE OPERATING TEMPERATURE	FULL POWER	-55	—	+125	°C
	ABSOLUTE ¹	-55	—	+135	
DERATING OUTPUT POWER/CURRENT ¹	LINEARLY	From 100% at 125°C to 0% at 135°C			
ESD RATING ¹ MIL-PRF-38534, 3.9.5.8.2	MIL STD 883 METHOD 3015 CLASS 3B	—	—	≥8000	V
ISOLATION: INPUT TO OUTPUT OR ANY PIN TO CASE EXCEPT CASE PINS	@ 500 VDC AT 25°C	100	—	—	Megohms
INPUT TO OUTPUT CAPACITANCE ¹		—	50	—	pF
CURRENT LIMIT ²	% OF FULL LOAD	—	140	—	%
AUDIO REJECTION ¹		—	40	—	dB
CONVERSION FREQUENCY, FREE RUN	-55°C TO +125°C	530	—	670	kHz
SYNCHRONIZATION -55°C TO +125°C	INPUT FREQUENCY	500	—	675	kHz
	DUTY CYCLE ¹	40	—	60	%
	ACTIVE LOW	—	—	0.8	V
	ACTIVE HIGH ¹	4.5	—	5.0	
	REFERENCED TO		INPUT COMMON		
IF NOT USED		CONNECT TO INPUT COMMON			
INHIBIT ACTIVE LOW (OUTPUT DISABLED) Do not apply a voltage to the inhibit pin. ³	INHIBIT PIN PULLED LOW	—	—	0.8	V
	INHIBIT PIN SOURCE CURRENT ¹	—	—	8	mA
	REFERENCED TO		INPUT COMMON		
INHIBIT ACTIVE HIGH (OUTPUT ENABLED) Do not apply a voltage to the inhibit pin. ³	INHIBIT PIN CONDITION	OPEN COLLECTOR OR UNCONNECTED			
	OPEN INHIBIT PIN VOLTAGE ¹	9	—	11	V

*For mean time between failures (MTBF) contact Applications Engineering
powerapps@crane-eg.com +1 425-882-3100 option 7*

Notes

1. Guaranteed by qualification test and/or analysis. Not an in-line test.
2. Dual outputs: The over-current limit will trigger when the sum of the currents from both outputs reaches 140% (typical value) of the maximum rated "total" current of both outputs.
3. An external inhibit interface should be used to pull the inhibit low or leave it floating. The inhibit pin can be left unconnected if not used.

MTR (50) Single and Dual DC-DC Converters

28 (16-50) VOLT INPUT – 30 WATT

TABLE 6: ELECTRICAL CHARACTERISTICS -55°C TO +125°C CASE, 28 VIN, 100% LOAD, FREE RUN, UNLESS OTHERWISE SPECIFIED.

SINGLE OUTPUT MODELS		MTR283R3S			MTR2805S			MTR288R5S			UNITS
PARAMETER	CONDITIONS	MIN	TYP	MAX	MIN	TYP	MAX	MIN	TYP	MAX	
OUTPUT VOLTAGE		3.201	3.30	3.399	4.85	5.00	5.15	8.23	8.5	8.77	V
OUTPUT CURRENT	V _{IN} = 16 TO 50 V	0	—	6.06	0	—	5.0	0	—	2.94	A
OUTPUT POWER	V _{IN} = 16 TO 50 V	0	—	20	0	—	25	0	—	25	W
OUTPUT RIPPLE 10 KHZ - 2 MHZ	T _C = 25°C	—	10	40	—	15	70	—	15	60	mV p-p
	T _C = -55°C TO +125°C	—	15	50	—	15	90	—	20	60	
LINE REGULATION	V _{IN} = 16 TO 50 V	—	0	10	—	2	50	—	2	50	mV
LOAD REGULATION	NO LOAD TO FULL	—	1	10	—	2	50	—	2	50	mV
INPUT VOLTAGE NO LOAD TO FULL	CONTINUOUS	16	28	50	16	28	50	16	28	50	V
	TRANSIENT 50 ms ¹	—	—	80	—	—	80	—	—	80	V
INPUT CURRENT	NO LOAD	—	40	80	—	50	80	—	50	80	mA
	INHIBITED	—	3	8	—	3	8	—	3	8	
INPUT RIPPLE CURRENT ²	10 KHZ - 10 MHZ	—	30	100	—	30	100	—	30	100	mA p-p
EFFICIENCY	T _C = 25°C	73	74	—	75	77	—	77	81	—	%
	T _C = -55°C TO +125°C	71	74	—	73	76	—	76	79	—	
LOAD FAULT ³	POWER DISSIPATION	—	8	12	—	8	12	—	6	12	W
SHORT CIRCUIT	RECOVERY ¹	—	1.4	6	—	1.4	5	—	1.4	5	ms
STEP LOAD RESPONSE ⁴ 50% - 100% - 50%	TRANSIENT	—	±80	±250	—	±100	±300	—	±150	±400	mV pk
	RECOVERY	—	50	200	—	50	200	—	30	200	μs
STEP LINE RESPONSE ^{1, 4} 16 - 40 - 16 V	TRANSIENT	—	—	±300	—	±200	±300	—	±400	±500	mV pk
	RECOVERY	—	—	400	—	—	400	—	—	400	μs
START-UP ⁵	DELAY	—	2.5	5	—	2.5	5	—	2.5	5	ms
FULL LOAD	OVERSHOOT ¹	—	0	50	—	0	80	—	0	150	mV pk
CAPACITIVE LOAD ¹	NO EFFECT ON DC	—	—	3000	—	—	3000	—	—	3000	μF
	PERFORMANCE										

Notes

1. Guaranteed by qualification test and/or analysis. Not an in-line test.
2. Tested with 6800 pF ceramic bypass capacitor connected externally from input common to case.
3. Indefinite short circuit protection not guaranteed above 125°C case.

4. Recovery time is measured from application of the transient to point at which V_{OUT} is within 1% of final value.
5. Tested on release from inhibit.

MTR (50) Single and Dual DC-DC Converters

28 (16-50) VOLT INPUT – 30 WATT

TABLE 7: ELECTRICAL CHARACTERISTICS -55°C TO +125°C CASE, 28 VIN, 100% LOAD, FREE RUN, UNLESS OTHERWISE SPECIFIED.

SINGLE OUTPUT MODELS		MTR2812S			MTR2815S			UNITS
PARAMETER	CONDITIONS	MIN	TYP	MAX	MIN	TYP	MAX	
OUTPUT VOLTAGE		11.64	12.00	12.36	14.55	15.00	15.45	V
OUTPUT CURRENT	$V_{IN} = 16 \text{ TO } 50 \text{ V}$	0	—	2.5	0	—	2.0	A
OUTPUT POWER	$V_{IN} = 16 \text{ TO } 50 \text{ V}$	0	—	30	0	—	30	W
OUTPUT RIPPLE 10 kHz - 2 MHz	$T_C = 25^\circ\text{C}$	—	10	40	—	10	40	mV p-p
	$T_C = -55^\circ\text{C TO } +125^\circ\text{C}$	—	15	90	—	15	90	
LINE REGULATION	$V_{IN} = 16 \text{ TO } 50 \text{ V}$	—	2	50	—	2	50	mV
LOAD REGULATION	NO LOAD TO FULL	—	2	50	—	2	50	mV
INPUT VOLTAGE NO LOAD TO FULL	CONTINUOUS	16	28	50	16	28	50	V
	TRANSIENT 50 ms ¹	—	—	80	—	—	80	V
INPUT CURRENT	NO LOAD	—	50	80	—	50	80	mA
	INHIBITED	—	3	8	—	3	8	
INPUT RIPPLE CURRENT ²	10 kHz - 10 MHz	—	35	100	—	35	100	mA p-p
EFFICIENCY	$T_C = 25^\circ\text{C}$	77	80	—	79	80	—	%
	$T_C = -55^\circ\text{C TO } +125^\circ\text{C}$	75	77	—	75	77	—	
LOAD FAULT ³	POWER DISSIPATION	—	6	12	—	5	12	W
SHORT CIRCUIT	RECOVERY ¹	—	1.4	5	—	1.4	5	ms
STEP LOAD RESPONSE ⁴ 50% - 100% - 50%	TRANSIENT	—	±150	±400	—	±150	±500	mV pk
	RECOVERY	—	30	200	—	30	200	µs
STEP LINE RESPONSE ^{1, 4} 16 - 40 - 16 V	TRANSIENT	—	±400	±500	—	±500	±600	mV pk
	RECOVERY	—	—	400	—	—	400	µs
START-UP ⁵	DELAY	—	2.5	5	—	2.5	5	ms
FULL LOAD	OVERSHOOT ¹	—	0	180	—	0	180	mV pk
CAPACITIVE LOAD ¹	NO EFFECT ON DC PERFORMANCE	—	—	3000	—	—	3000	µF

Notes

1. Guaranteed by qualification test and/or analysis. Not an in-line test.
2. Tested with 6800 pF ceramic bypass capacitor connected externally from input common to case.
3. Indefinite short circuit protection not guaranteed above 125°C case.

4. Recovery time is measured from application of the transient to point at which V_{OUT} is within 1% of final value.
5. Tested on release from inhibit.

MTR (50) Single and Dual DC-DC Converters

28 (16-50) VOLT INPUT – 30 WATT

TABLE 8: ELECTRICAL CHARACTERISTICS -55°C TO +125°C CASE, 28 VIN, 100% LOAD, FREE RUN, UNLESS OTHERWISE SPECIFIED.

DUAL OUTPUT MODELS		MTR2805D			MTR2812D			MTR2815D			UNITS
PARAMETER	CONDITIONS	MIN	TYP	MAX	MIN	TYP	MAX	MIN	TYP	MAX	
OUTPUT VOLTAGE	+ V _{OUT}	4.850	5.00	5.150	11.64	12.00	12.36	14.55	15.00	15.45	V
	- V _{OUT}	4.825	5.00	5.172	11.58	12.00	12.42	14.47	15.00	15.53	
OUTPUT CURRENT ² V _{IN} = 16 TO 50 V	EITHER OUTPUT	0	2.5	4.5 ¹	0	1.25	2.25 ¹	0	1.00	1.80 ¹	A
	TOTAL OUTPUT	—	—	5	—	—	2.5	—	—	2.00	
OUTPUT POWER ² V _{IN} = 16 TO 50 V	EITHER OUTPUT	0	12.5	22.5 ¹	0	15	27 ¹	0	15	27 ¹	W
	TOTAL OUTPUT	—	—	25	—	—	30	—	—	30	
OUTPUT RIPPLE 10 kHz - 2 MHz ± V _{OUT}	T _C = 25°C	—	5	40	—	20	80	—	20	80	mV p-p
	T _C = -55°C TO +125°C	—	10	90	—	30	120	—	20	120	
LINE REGULATION V _{IN} = 16 TO 50 V	+ V _{OUT}	—	2	50	—	2	50	—	2	50	mV
	- V _{OUT}	—	5	100	—	20	150	—	40	180	
LOAD REGULATION NO LOAD TO FULL	+ V _{OUT}	—	2	50	—	2	50	—	2	50	mV
	- V _{OUT}	—	10	100	—	20	150	—	20	180	
CROSS REGULATION ¹	SEE NOTE 3	—	6	10	—	3	6	—	3	6	%
EFFECT ON -V _{OUT} , 25°C	SEE NOTE 4	—	9	14	—	5	9	—	6	9	
INPUT VOLTAGE NO LOAD TO FULL	CONTINUOUS	16	28	50	16	28	50	16	28	50	V
	TRANSIENT 50 ms. ¹	—	—	80	—	—	80	—	—	80	V
INPUT CURRENT	NO LOAD	—	50	90	—	60	90	—	60	90	mA
	INHIBITED	—	3	8	—	3	8	—	3	8	
INPUT RIPPLE CURRENT ⁵	10 kHz - 10 MHz	—	25	100	—	30	100	—	30	100	mA p-p
EFFICIENCY BALANCED LOAD	T _C = 25°C	76	79	—	76	80	—	78	80	—	%
	T _C = -55°C TO +125°C	73	78	—	74	77	—	75	77	—	
LOAD FAULT ⁶	POWER DISSIPATION	—	7	12	—	5	12	—	5	12	W
SHORT CIRCUIT	RECOVERY ¹	—	1.4	5.0	—	1.4	5.0	—	1.4	5.0	ms
STEP LOAD RESPONSE ⁷ 50% - 100% - 50% ± V _{OUT}	TRANSIENT	—	±80	±300	—	±130	±300	—	±120	±400	mV pk
	RECOVERY	—	70	200	—	10	200	—	10	200	μs
STEP LINE RESPONSE ^{1, 7} 16 - 40 - 16 V ± V _{OUT}	TRANSIENT	—	±200	±400	—	±200	±400	—	±400	±500	mV pk
	RECOVERY	—	—	400	—	—	400	—	—	400	μs
START-UP ⁸	DELAY	—	2.5	5	—	2.5	5	—	2.5	5	ms
FULL LOAD	OVERSHOOT ¹	—	0	180	—	0	180	—	0	180	mV pk
CAPACITIVE LOAD ^{1, 9}	NO EFFECT ON DC	—	—	1500	—	—	1500	—	—	1500	μF
	PERFORMANCE	—	—	1500	—	—	1500	—	—	1500	

Notes

- Guaranteed by qualification test and/or analysis. Not an in-line test.
- Up to 90% of the total output current/power is available from either output providing the opposite output is carrying at least 10% of the total output power.
- Effect on negative V_{OUT} from 50%/50% loads to 80%/20% or 20%/80% loads.
- Effect on negative V_{OUT} from 50%/50% loads to 90%/10% or 10%/90% loads. See Figure 21 on page 14.
- Tested with 6800 pF ceramic bypass capacitor connected externally from input common to case.

- Indefinite short circuit protection not guaranteed above 125°C case.

- Recovery time is measured from application of the transient to point at which V_{OUT} is within 1% of final value.
- Tested on release from inhibit.
- Applies to each output.

MTR (50) Single and Dual DC-DC Converters

28 (16-50) VOLT INPUT – 30 WATT

TYPICAL PERFORMANCE PLOTS: 25°C CASE, 28 VIN, 100% LOAD, FREE RUN, UNLESS OTHERWISE SPECIFIED.
FOR REFERENCE ONLY, NOT GUARANTEED SPECIFICATIONS.

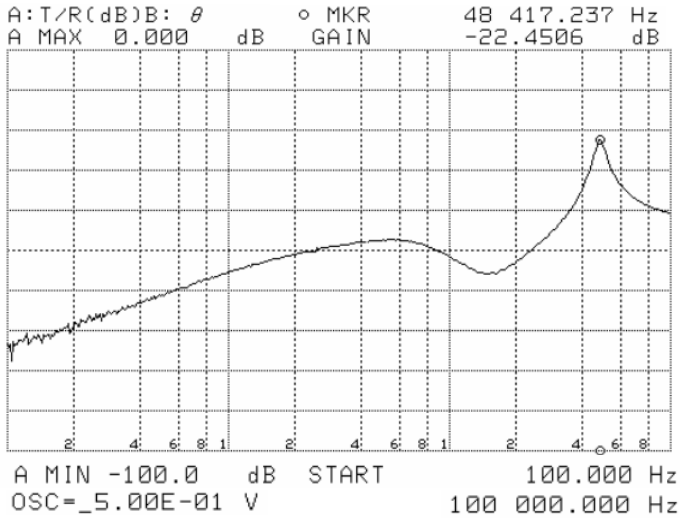

MTR2805S AUDIO REJECTION

FIGURE 9

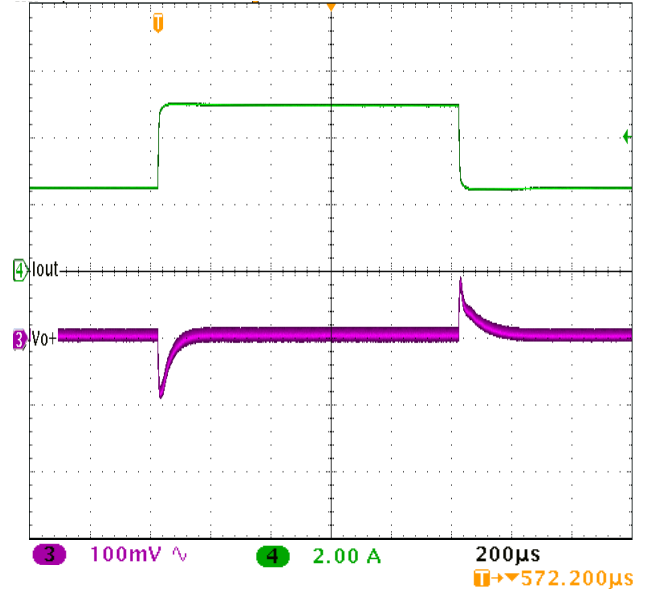

MTR2805S STEP LOAD 50% - 100% - 50%

FIGURE 10

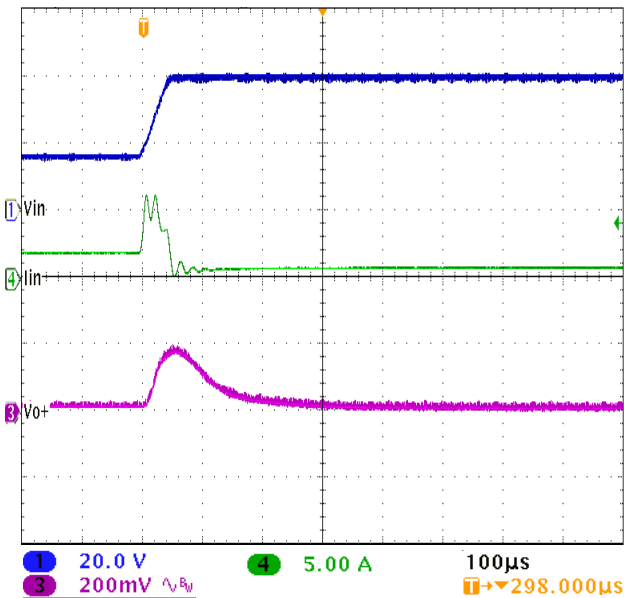

MTR2805S STEP LINE 16 - 40 VOLTS

FIGURE 11

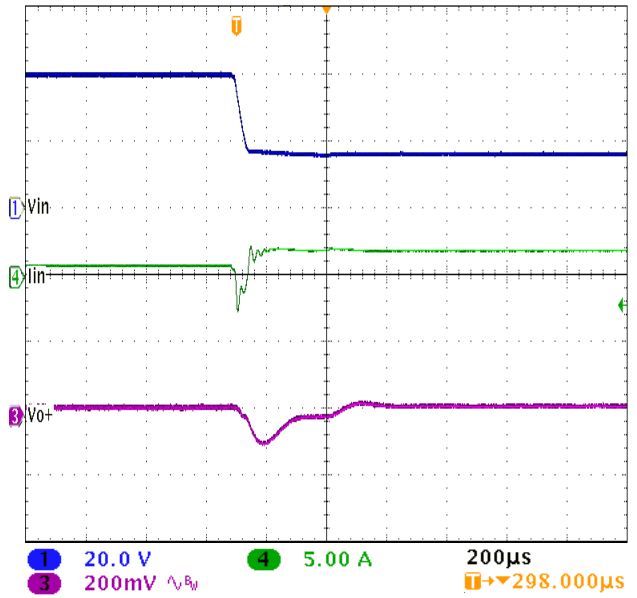

MTR2805S STEP LINE 40 - 16 VOLTS

FIGURE 12

MTR (50) Single and Dual DC-DC Converters

28 (16-50) VOLT INPUT – 30 WATT

TYPICAL PERFORMANCE PLOTS: 25°C CASE, 28 VIN, 100% LOAD, FREE RUN, UNLESS OTHERWISE SPECIFIED.
FOR REFERENCE ONLY, NOT GUARANTEED SPECIFICATIONS.

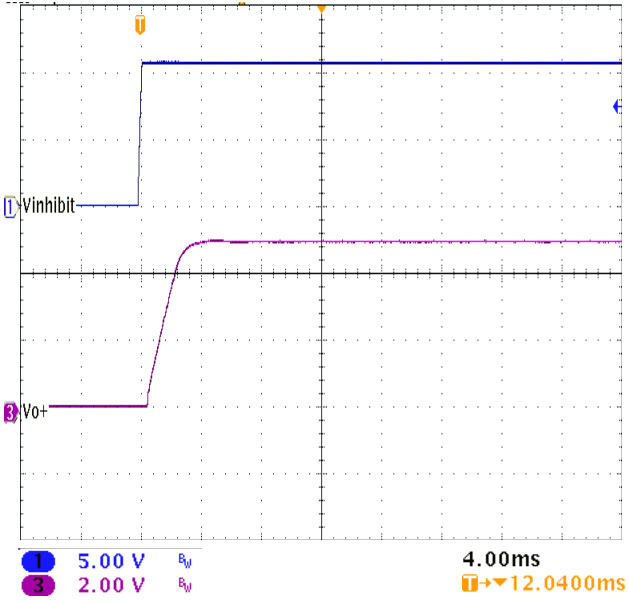

MTR2805S START-UP INTO NO LOAD, 3000 µF CAP LOAD
FIGURE 13

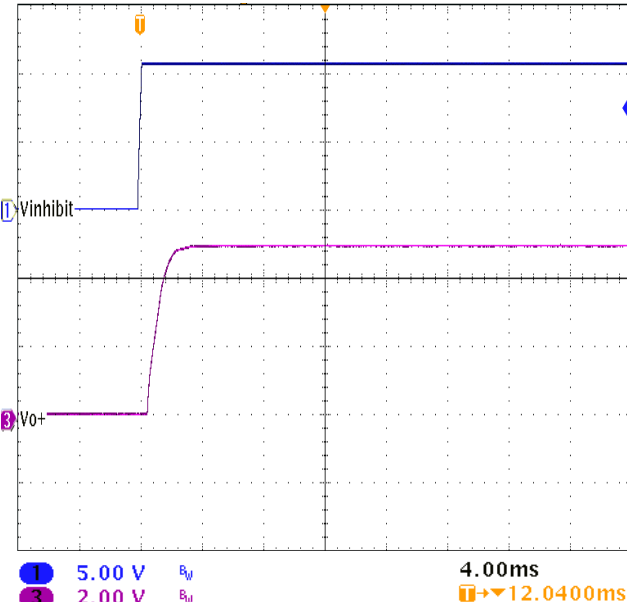

MTR2805S START-UP INTO NO LOAD
FIGURE 14

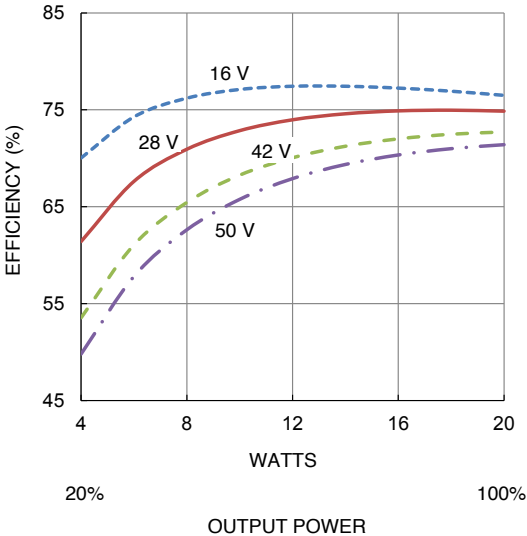

MTR283R3S EFFICIENCY
FIGURE 15

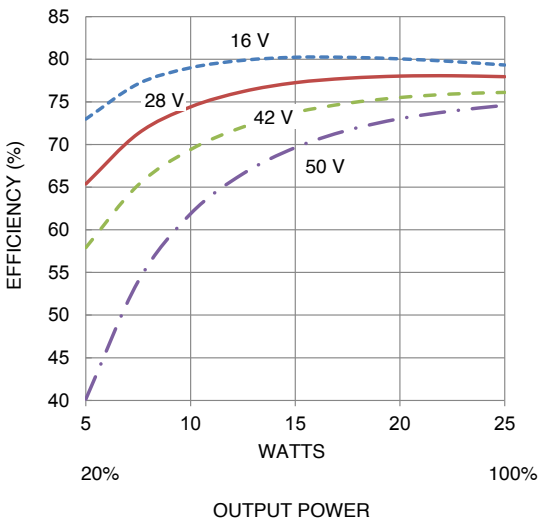

MTR2805S EFFICIENCY
FIGURE 16

MTR (50) Single and Dual DC-DC Converters

28 (16-50) VOLT INPUT – 30 WATT

TYPICAL PERFORMANCE PLOTS: 25°C CASE, 28 VIN, 100% LOAD, FREE RUN, UNLESS OTHERWISE SPECIFIED.
FOR REFERENCE ONLY, NOT GUARANTEED SPECIFICATIONS.

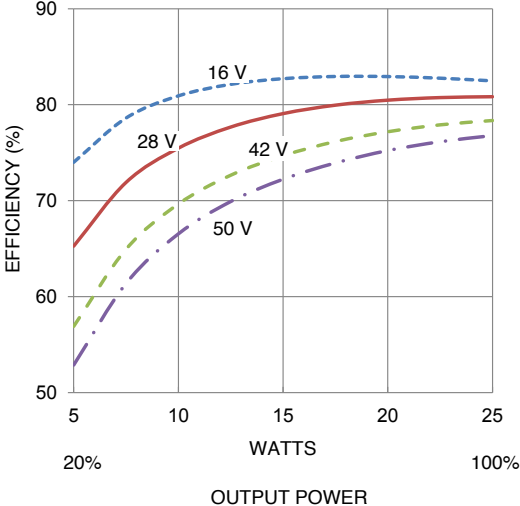

MTR288R5S EFFICIENCY

FIGURE 17

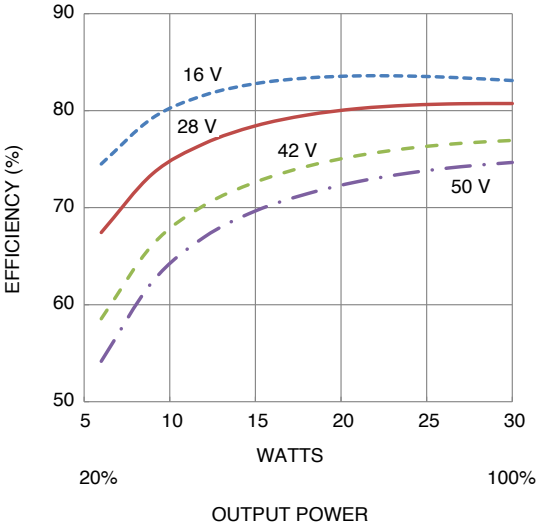

MTR2812S EFFICIENCY

FIGURE 18

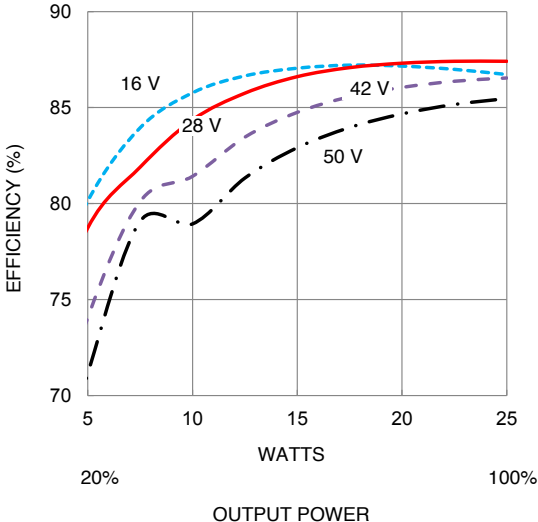

MTR2815S EFFICIENCY

FIGURE 19

MTR (50) Single and Dual DC-DC Converters

28 (16-50) VOLT INPUT – 30 WATT

TYPICAL PERFORMANCE PLOTS: 25°C CASE, 28 VIN, 100% LOAD, FREE RUN, UNLESS OTHERWISE SPECIFIED.
FOR REFERENCE ONLY, NOT GUARANTEED SPECIFICATIONS.

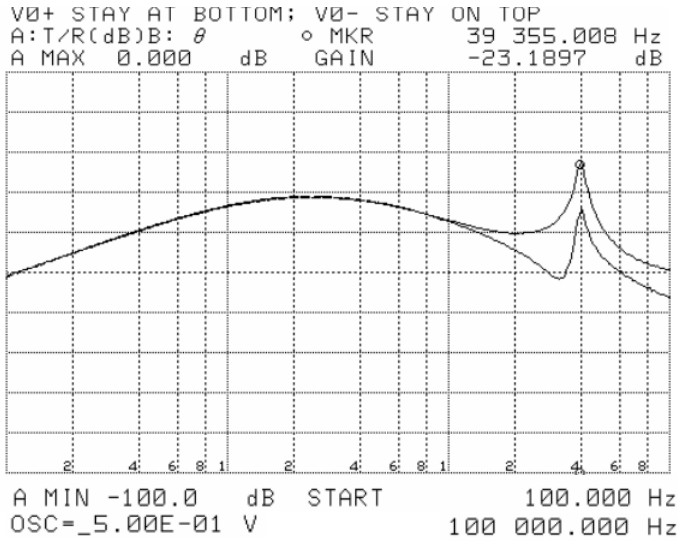

MTR2815D AUDIO REJECTION

FIGURE 20

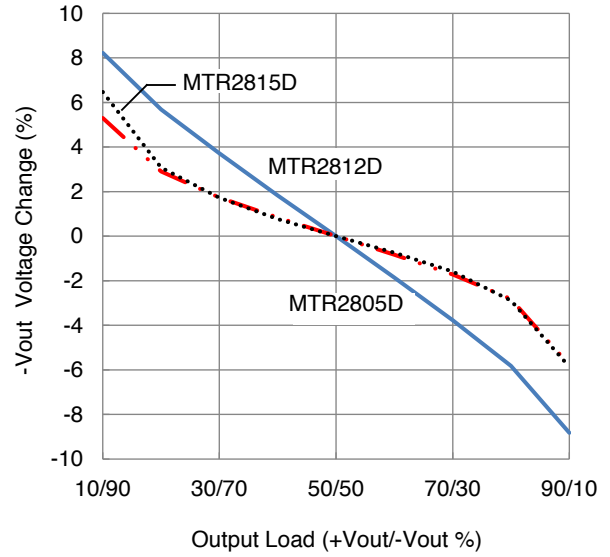

MTR CROSS REGULATION

FIGURE 21

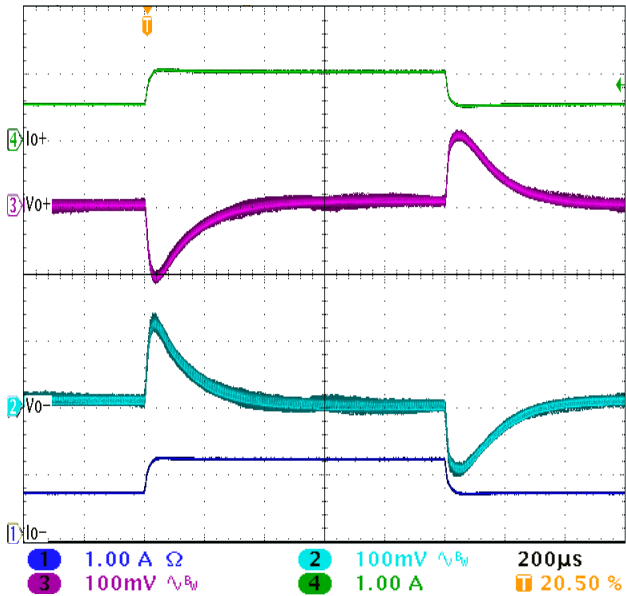

MTR2815D STEP LOAD 50% - 100% - 50%

FIGURE 22

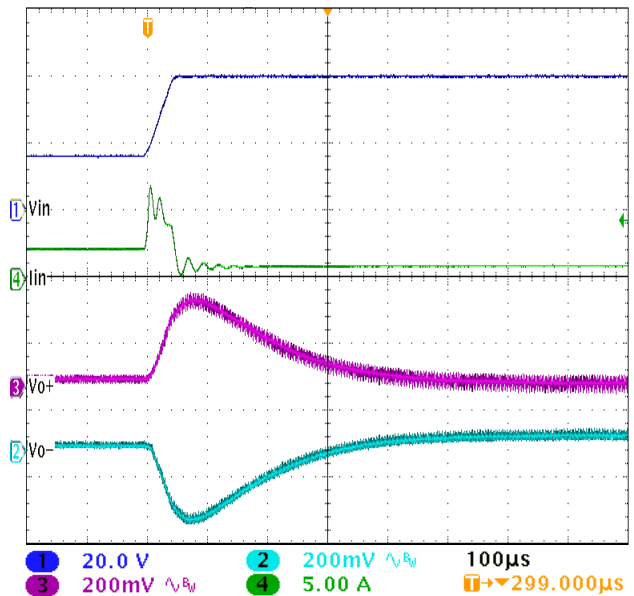

MTR2815D STEP LINE 16 - 40 VOLTS

FIGURE 23

MTR (50) Single and Dual DC-DC Converters

28 (16-50) VOLT INPUT – 30 WATT

TYPICAL PERFORMANCE PLOTS: 25°C CASE, 28 VIN, 100% LOAD, FREE RUN, UNLESS OTHERWISE SPECIFIED.
FOR REFERENCE ONLY, NOT GUARANTEED SPECIFICATIONS.

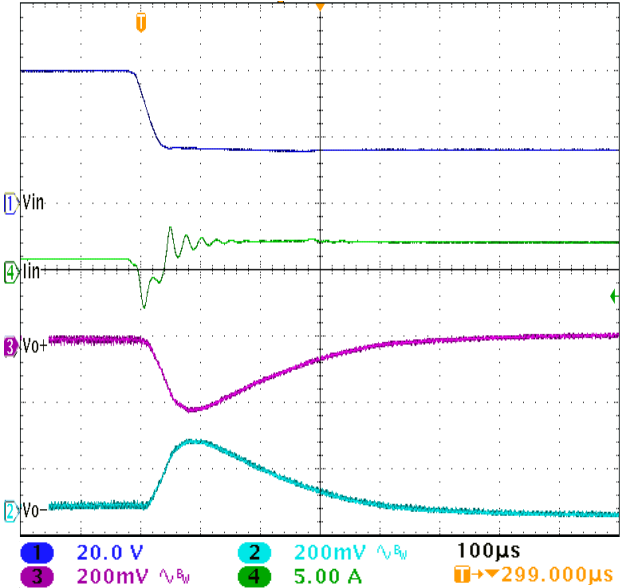

MTR2815D STEP LINE 40 - 16 VOLTS

FIGURE 24

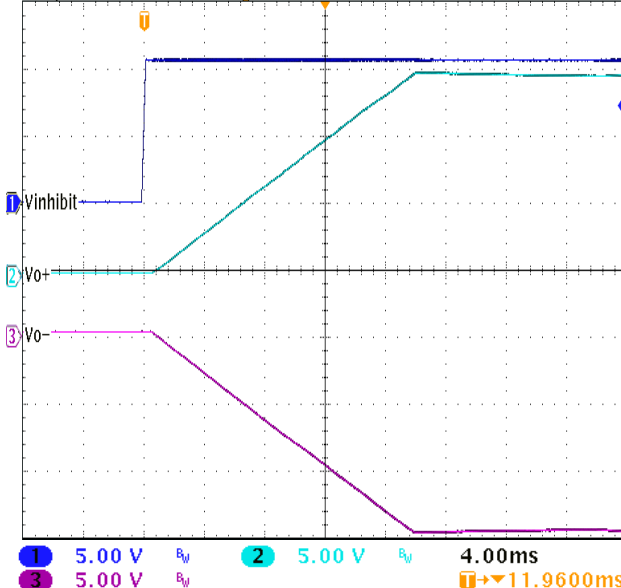

MTR2815D START-UP INTO NO LOAD, 1500 µF CAP LOAD EACH

FIGURE 25

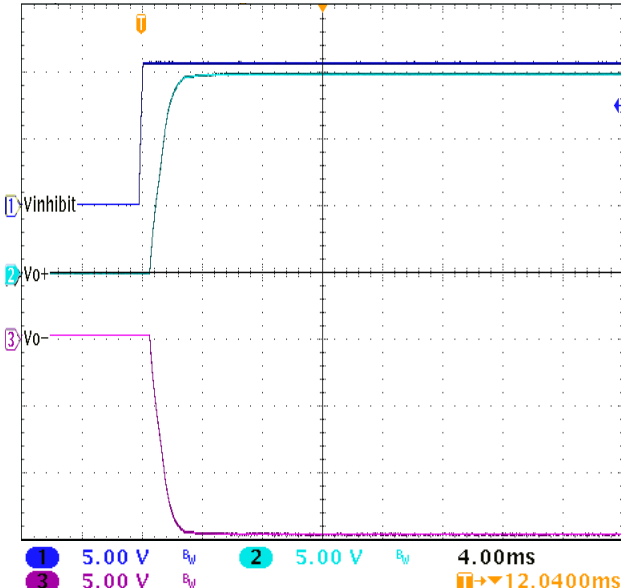

MTR2815D START-UP INTO NO LOAD

FIGURE 26

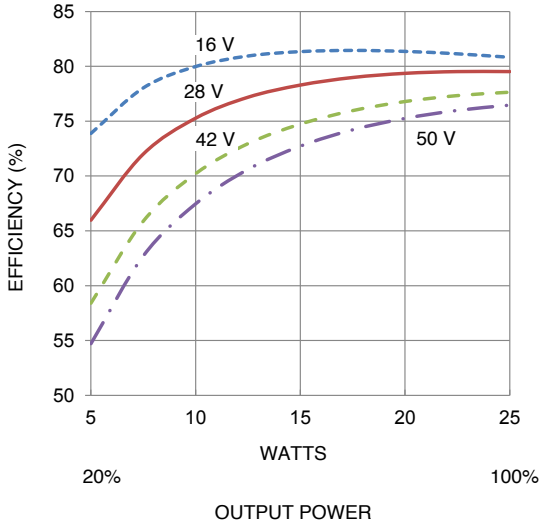

MTR2805D EFFICIENCY

FIGURE 27

MTR (50) Single and Dual DC-DC Converters

28 (16-50) VOLT INPUT – 30 WATT

TYPICAL PERFORMANCE PLOTS: 25°C CASE, 28 VIN, 100% LOAD, FREE RUN, UNLESS OTHERWISE SPECIFIED.
FOR REFERENCE ONLY, NOT GUARANTEED SPECIFICATIONS.

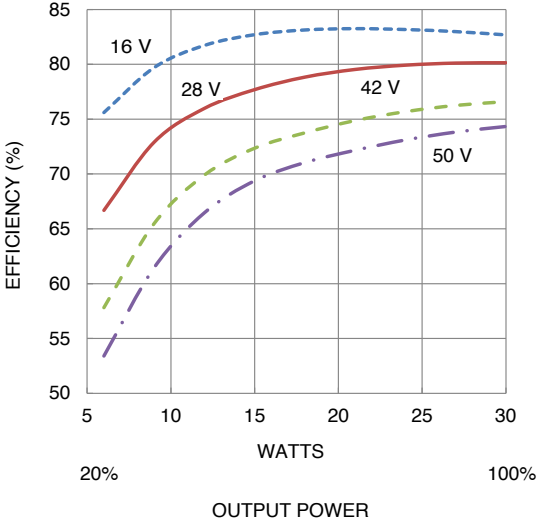

MTR2812D EFFICIENCY

FIGURE 28

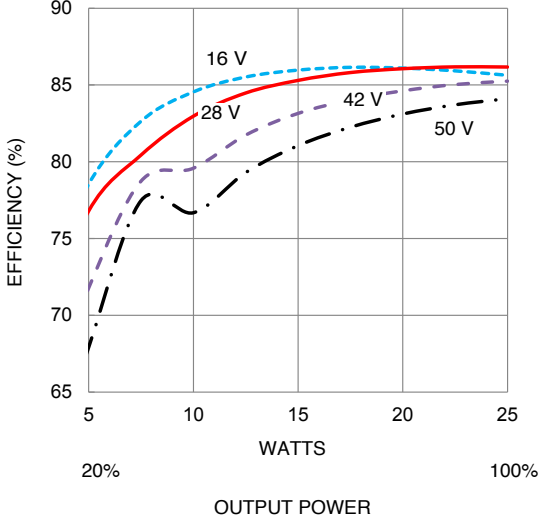

MTR2815D EFFICIENCY

FIGURE 29

MTR (50) Single and Dual DC-DC Converters

28 (16-50) VOLT INPUT – 30 WATT

BOTTOM VIEW MTR SINGLE AND DUAL

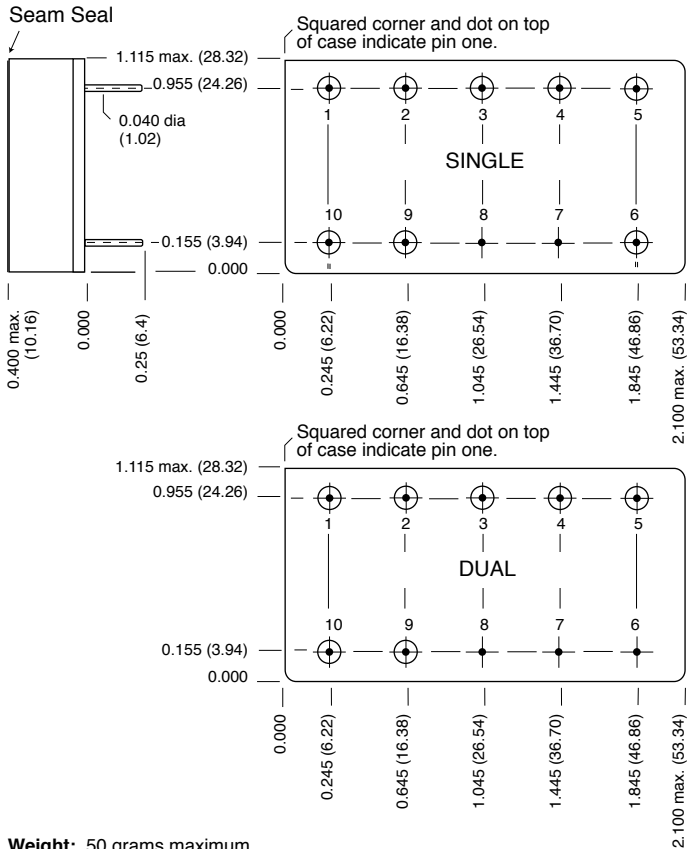

Weight: 50 grams maximum

Case dimensions in inches (mm)
 Tolerance ±0.005 (0.13) for three decimal places
 ±0.01 (0.3) for two decimal places
 unless otherwise specified

CAUTION
 Heat from reflow or wave soldering may damage the device.
 Solder pins individually with heat application not exceeding 300°C for 10 seconds per pin.

Materials

Header	Cold Rolled Steel/Nickel/Gold
Cover	Kovar/Nickel
Pins	#52 alloy/Gold ceramic seal
	Gold plating of 50 - 150 microinches included in pin diameter
	Seal hole 0.120 ±0.002 (3.05 ± 0.05)

Case H2 MTR SD, Rev L, 2015.04.21
 Please refer to the numerical dimensions for accuracy..

FIGURE 30: CASE H2

MTR (50) Single and Dual DC-DC Converters

28 (16-50) VOLT INPUT – 30 WATT

BOTTOM VIEW MTR SINGLE AND DUAL FLANGED
 Flanged cases: Designator "F" required in Case Option position of model number.

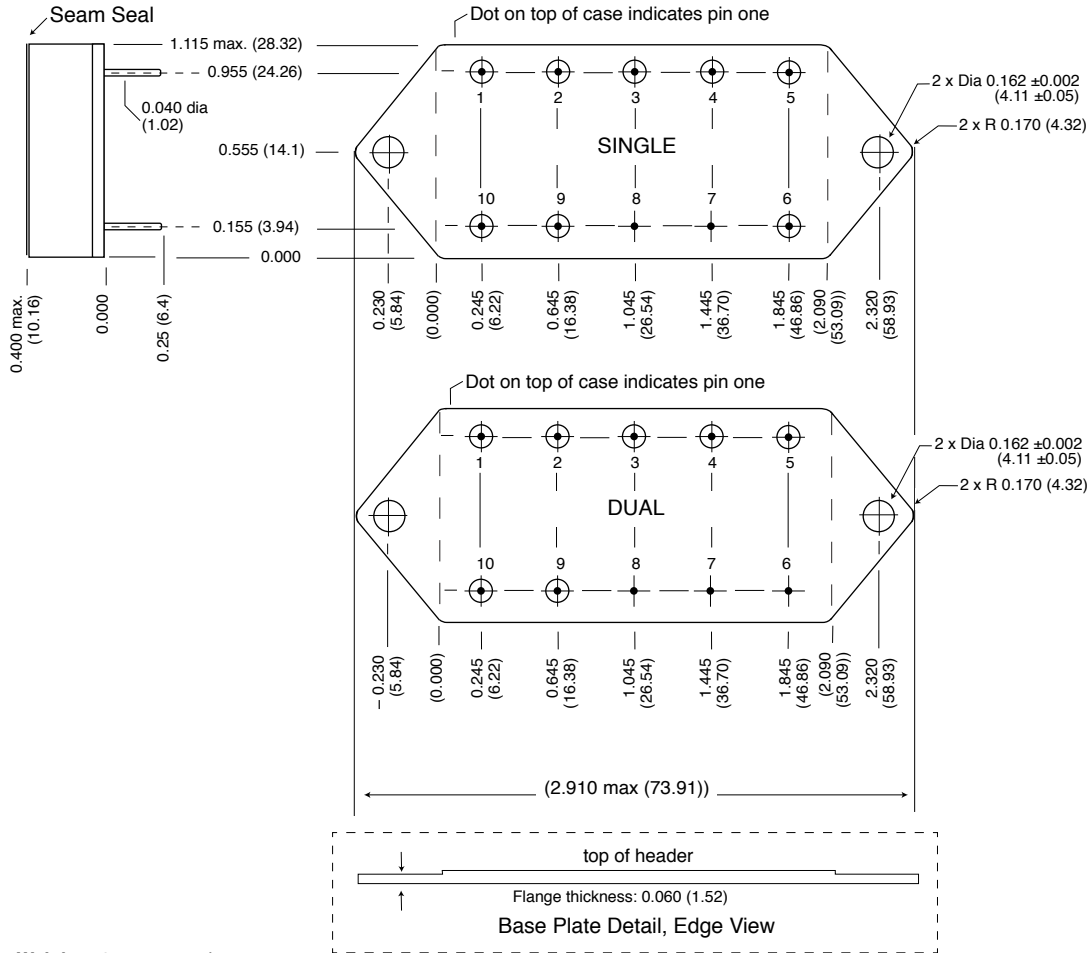

Weight: 52 grams maximum

Case dimensions in inches (mm)

Tolerance ±0.005 (0.13) for three decimal places
 ±0.01 (0.3) for two decimal places
 unless otherwise specified

CAUTION

Heat from reflow or wave soldering may damage the device. Solder pins individually with heat application not exceeding 300°C for 10 seconds per pin.

Materials

Header Cold Rolled Steel/Nickel/Gold
 Cover Kovar/Nickel
 Pins #52 alloy/Gold, ceramic seal
 Gold plating of 50 - 150 microinches included in pin diameter
 Seal hole 0.120 ±0.002 (3.04 ±0.05)

Case K3 MTR SD F, Rev M, 2015.04.21
 Please refer to the numerical dimensions for accuracy.

FIGURE 31: CASE K3

MTR (50) Single and Dual DC-DC Converters

28 (16-50) VOLT INPUT – 30 WATT

ELEMENT EVALUATION ¹ HIGH RELIABILITY /883 (CLASS H)

COMPONENT-LEVEL TEST PERFORMED	QML	
	CLASS H /883	
	M/S ²	P ³
Element Electrical	■	■
Visual	■	■
Internal Visual	■	
Final Electrical	■	■
Wire Bond Evaluation	■	■

Notes

1. Element evaluation does not apply to standard and /ES product.
2. M/S = Active components (microcircuit and semiconductor die).
3. P = Passive components, Class H element evaluation. Not applicable to standard and /ES element evaluation.

TABLE 9: ELEMENT EVALUATION

MTR (50) Single and Dual DC-DC Converters

28 (16-50) VOLT INPUT – 30 WATT

ENVIRONMENTAL SCREENING HIGH RELIABILITY STANDARD, /ES AND /883 (CLASS H)

TEST PERFORMED	NON-QML ¹		QML ²
	STANDARD	/ES	CLASS H /883
Pre-cap Inspection, Method 2017, 2032	■	■	■
Temperature Cycle (10 times)			
Method 1010, Cond. C, -65°C to +150°C, ambient			■
Method 1010, Cond. B, -55°C to +125°C, ambient		■	
Constant Acceleration			
Method 2001, 3000 g			■
Method 2001, 500 g		■	
PIND, Test Method 2020, Cond. A			■ ³
Burn-in Method 1015, +125°C case, typical ⁴			
96 hours		■	
160 hours			■
Final Electrical Test, MIL-PRF-38534, Group A,			
Subgroups 1 through 6, -55°C, +25°C, +125°C case			■
Subgroups 1 and 4, +25°C case	■	■	
Hermeticity Test			
Gross Leak, Cond. C ₁ , fluorocarbon		■	■
Fine Leak, Cond. A ₂ , helium		■	■
Gross Leak, Dip	■		
Final visual inspection, Method 2009	■	■	■

Test methods are referenced to MIL-STD-883 as determined by MIL-PRF-38534.

Notes

- Standard and ES are non-QML products and may not meet all of the requirements of MIL-PRF-38534.
- All processes are QML qualified and performed by certified operators.
- Not required by DLA but performed to assure product quality.
- Burn-in temperature designed to bring the case temperature to +125°C minimum.
Burn-in is a powered test.

TABLE 10: ENVIRONMENTAL SCREENING