



MODEL: WST-1307S
PRODUCT: Electromagnetic Buzzer
EDITION: A/2017

THIS SPECIFICATION APPLIES TO THE ELECTROMAGNETIC BUZZER

SPECIFICATION

Test condition: TEMP=+25 ±2 °C Related Humidity= 65 ±5% Air Pressure: 860 ~ 1060mbar

item	unit	specification	condition
rated voltage	Vo-p	5.0	
operating voltage	Vo-p	3.0 ~ 7.0	
mean current	mA	MAX.40	At rated voltage direct current
sound output	dBA	90	At 10cm (A-weight free air) At rated voltage direct current
rated frequency	Hz	2400 ±200	
operating temperature	°C	-30 ~ +85	
storage temperature	°C	-40 ~ +85	
dimension	mm	12.8 × 12.8 × 7.1	See appearance drawing.
weight	gram	2.0	
material		PPS(gray)	
terminal		SMD Type (Plating Sn)	See appearance drawing
environmental protection regulation		RoHS	

ENVIRONMENT TEST

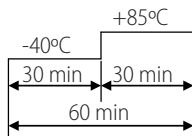
item	test condition and requirement	evaluation standard
high temperature test	After being placed in a chamber at +80°C for 96 hours.	After the test the part will meet specifications without any degradation in appearance and performance except SPL, after 4 hours at +25°C.
low temperature test (storage)	After being placed in a chamber at -40°C for 96 hours.	The SPL will be in ±10dBA compared with the initial one.
thermal shock	The part will be subjected to 10 cycles. One cycle shall consist of: 	

temperature/humidity cycle test	The part will be subjected to 10 cycles, one cycle shall be 24 hours and consist of:
---------------------------------	--

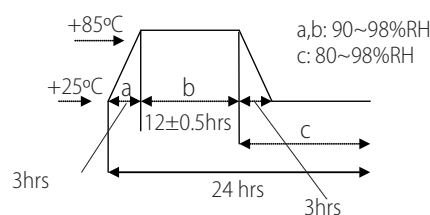



MODEL: WST-1307S
PRODUCT: Electromagnetic Buzzer
EDITION: A/2017

RELIABILITY TEST

item	test conditions	evaluation standard
operating life test	ORDINARY TEMPERATURE The part will be subjected to 96 hours of continuous operation at $+25 \pm 10^{\circ}\text{C}$.	After the test the part will meet specifications without any degradation in appearance and performance except SPL, after 4 hours at $+25^{\circ}\text{C}$. The SPL will be in $\pm 10\text{dBA}$ compared with the initial one.
	HIGH TEMPERATURE The part will be subjected to 72 hours of continuous operation at $+60^{\circ}\text{C}$ with 5V, 2400Hz applied.	
	LOW TEMPERATURE The part will be subjected to 72 hours of continuous operation at -20°C with 5V, 2400Hz applied.	
	HIGH AND LOW VOLTAGE Applying 4 voltage and 7 voltage, available time 24 hours each.	

TEST CONDITION

Standard Test Condition: a) Temperature : $+5 \sim +35^{\circ}\text{C}$ b) Humidity : 45 ~ 85% c) Pressure : 860 ~ 1060mbar

MECHANICAL CHARACTERISTICS

item	test conditions	evaluation standard
solderability	Lead terminal are immersed in rosin for 5 seconds and then immersed in solder bath of $+250 \pm 5^{\circ}\text{C}$ for 3 ± 0.5 seconds	90% min. lead terminals will be wet with solder
soldering heat resistance	Lead terminals are immersed in soldering bath of $+250 \pm 5^{\circ}\text{C}$ for 2 ± 0.5 seconds.	No interference in operation.
terminal mechanical strength	Apply the terminal with 1KG strength for 1 minute.	No damage and cutting off.
vibration	The part will be subjected to a vibration cycle of 10Hz to 55Hz to 10Hz in a period of 1 minute. Total peak amplitude will be 1.52mm(9.3G). The vibration test will consist of 2 hours per axis in each three axes(X,Y,Z). Total 6 hours.	After the test the part will meet specifications without any damage in appearance and performance except SPL. The SPL would be 10dBA compared with the initial one.
drop test	The part only will be dropped from a height of 75cm onto a 40mm thick wooden board 3 times in 3 axes(X,Y,Z). A total of 9 times.	

RECOMMENDED WAVE SOLDERING TEMPERATURE CURVE

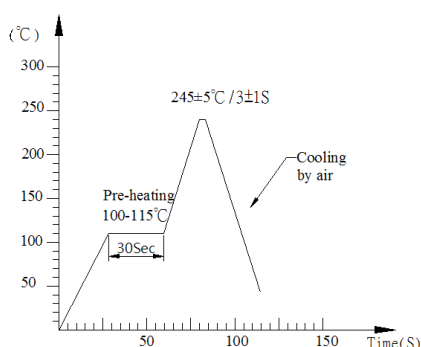



MODEL: WST-1307S
PRODUCT: Electromagnetic Buzzer
EDITION: A/2017

INSPECTION FIXTURE

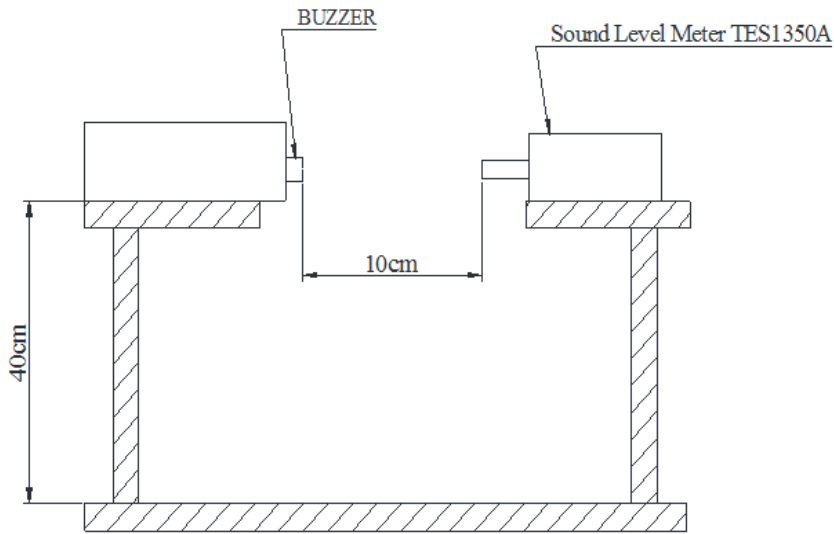

RECOMMENDED LAND PATTERN

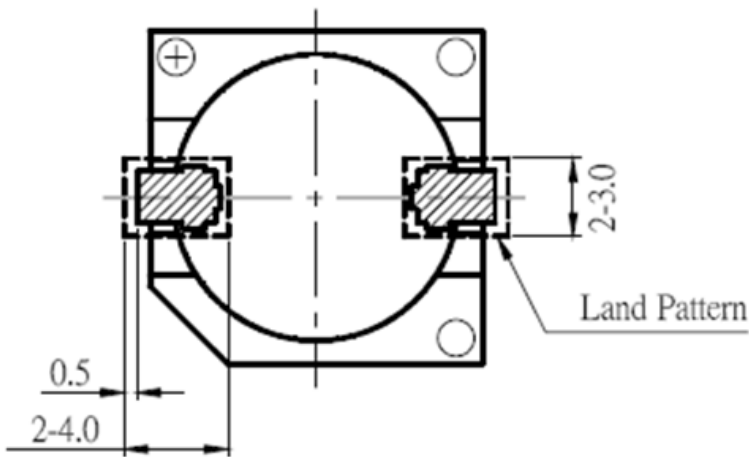

FREQUENCY RESPONSE

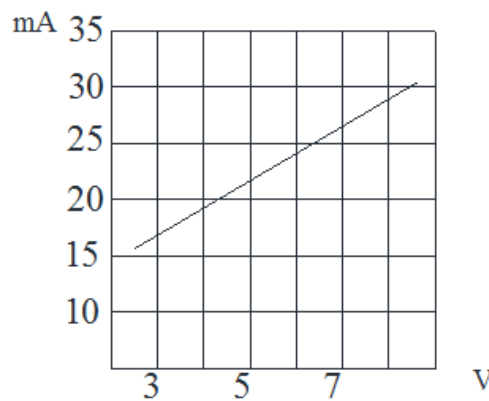
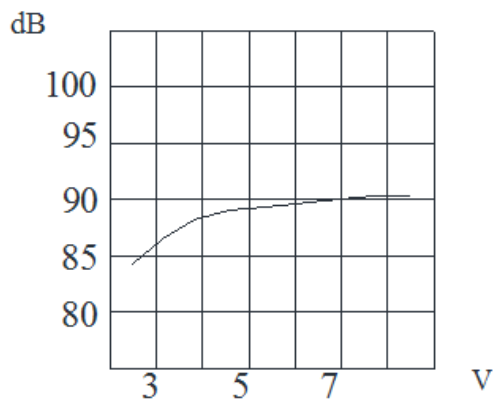



MODEL: WST-1307S
PRODUCT: Electromagnetic Buzzer
EDITION: A/2017

DIMENSIONS

Tolerance:±0.5 (unit: mm)

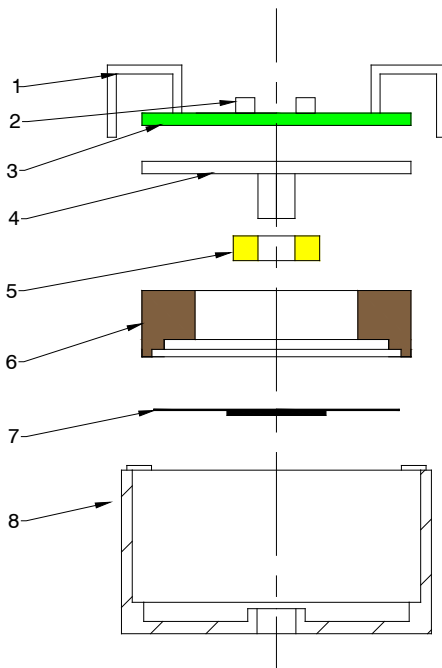
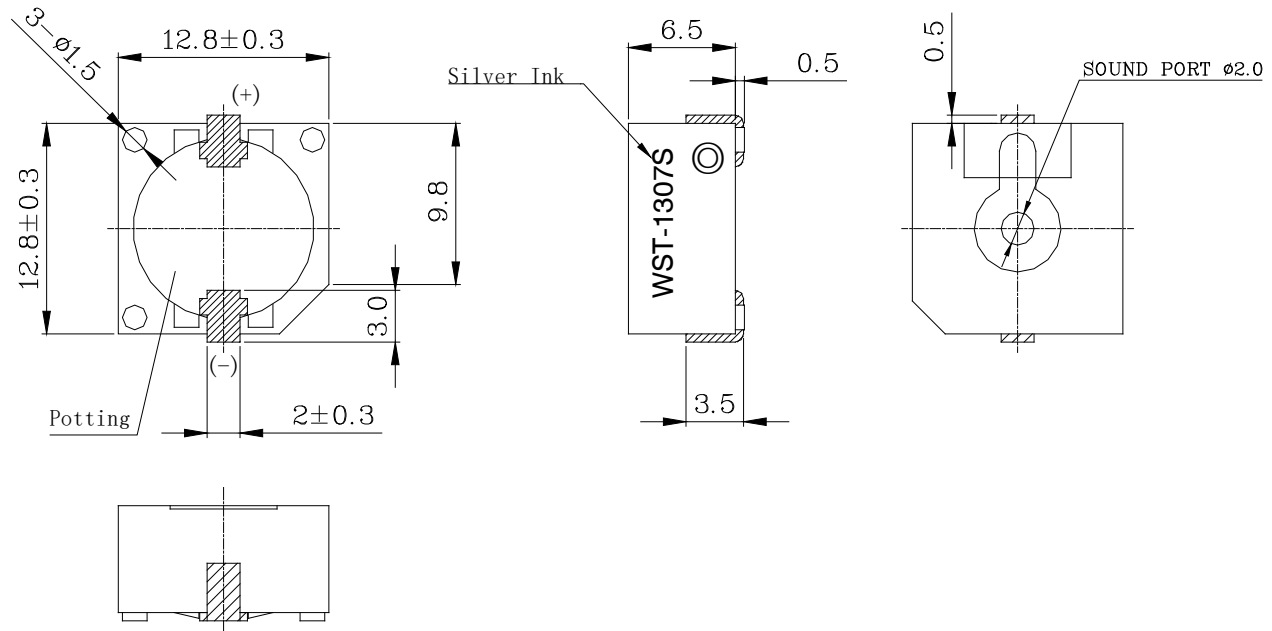

no	components	material	quantity
1	PIN	Copper	2
2	Transistor	Epoxy + Copper	2
3	PCB	Epoxy glass fiber cloth + copper	1
4	Core	Ferrum	1
5	Coil	Copper	1
6	Magnet ring	Poly+Ferrite	1
7	Diaphragm	Ferrum	1
8	Case	PPS	1



MODEL: WST-1307S
PRODUCT: Electromagnetic Buzzer
EDITION: A/2017

PACKING

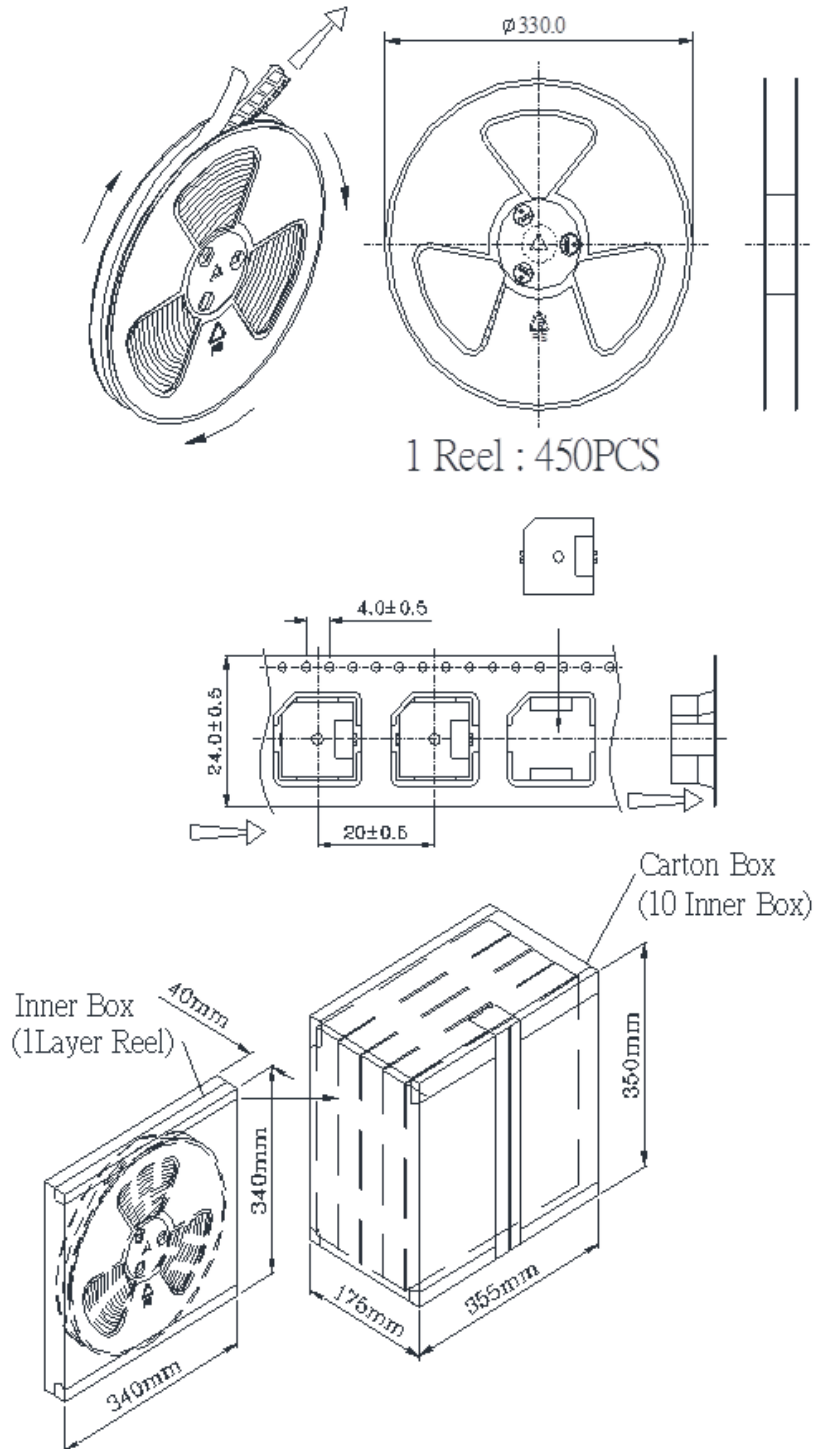

packing box	L x W x H (mm)	pieces
Inner Box	340x340x40	1 x 450 = 450pcs
Carton box	350 x 355 x 175	10 x 450 = 4,500pcs