

MITSUBISHI Nch POWER MOSFET

FK20SM-10

HIGH-SPEED SWITCHING USE

FK20SM-10

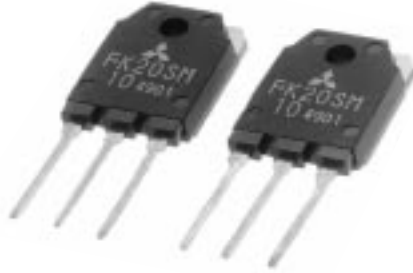

- V_{DSS} 500V
- $r_{DS(ON)}$ (MAX) 0.36Ω
- I_D 20A
- Integrated Fast Recovery Diode (MAX.) 150ns

OUTLINE DRAWING

Dimensions in mm

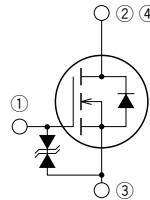
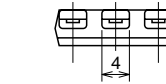
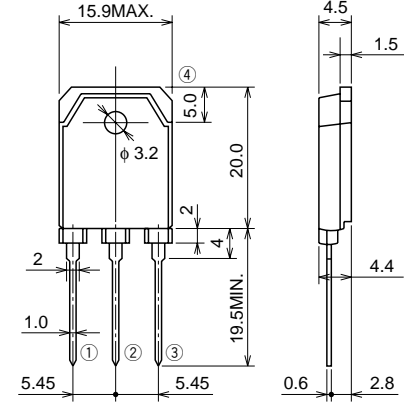

- ① GATE
- ② DRAIN
- ③ SOURCE
- ④ DRAIN

TO-3P

APPLICATION

Servo motor drive, Robot, UPS, Inverter Fluorecent lamp, etc.

MAXIMUM RATINGS (Tc = 25°C)

Symbol	Parameter	Conditions	Ratings	Unit
V_{DSS}	Drain-source voltage	$V_{GS} = 0V$	500	V
V_{GSS}	Gate-source voltage	$V_{DS} = 0V$	± 30	V
I_D	Drain current		20	A
I_{DM}	Drain current (Pulsed)		60	A
I_S	Source current		20	A
I_{SM}	Source current (Pulsed)		60	A
P_D	Maximum power dissipation		275	W
T_{ch}	Channel temperature		-55 ~ +150	°C
T_{stg}	Storage temperature		-55 ~ +150	°C
—	Weight	Typical value	4.8	g

ELECTRICAL CHARACTERISTICS (T_{ch} = 25°C)

Symbol	Parameter	Test conditions	Limits			Unit
			Min.	Typ.	Max.	
V (BR) DSS	Drain-source breakdown voltage	I _D = 1mA, V _{GS} = 0V	500	—	—	V
V (BR) GSS	Gate-source breakdown voltage	I _G = ±100μA, V _{DS} = 0V	±30	—	—	V
I _{GSS}	Gate-source leakage current	V _{GS} = ±25V, V _{DS} = 0V	—	—	±10	μA
I _{DSS}	Drain-source leakage current	V _{DS} = 500V, V _{GS} = 0V	—	—	1	mA
V _{GS} (th)	Gate-source threshold voltage	I _D = 1mA, V _{DS} = 10V	2	3	4	V
r _{DS} (ON)	Drain-source on-state resistance	I _D = 10A, V _{GS} = 10V	—	0.28	0.36	Ω
V _{DS} (ON)	Drain-source on-state voltage	I _D = 10A, V _{GS} = 10V	—	2.80	3.60	V
y _{fs}	Forward transfer admittance	I _D = 10A, V _{DS} = 10V	7.0	10.0	—	S
C _{iss}	Input capacitance	V _{DS} = 25V, V _{GS} = 0V, f = 1MHz	—	2800	—	pF
C _{oss}	Output capacitance		—	350	—	pF
C _{rss}	Reverse transfer capacitance		—	55	—	pF
t _d (on)	Turn-on delay time	V _{DD} = 200V, I _D = 10A, V _{GS} = 10V, R _{GEN} = R _{GS} = 50Ω	—	60	—	ns
t _r	Rise time		—	80	—	ns
t _d (off)	Turn-off delay time		—	270	—	ns
t _f	Fall time		—	80	—	ns
V _{SD}	Source-drain voltage	I _S = 10A, V _{GS} = 0V	—	1.5	2.0	V
R _{th} (ch-c)	Thermal resistance	Channel to case	—	—	0.45	°C/W
t _{rr}	Reverse recovery time	I _S = 20A, di _s /dt = -100A/μs	—	—	150	ns

PERFORMANCE CURVES

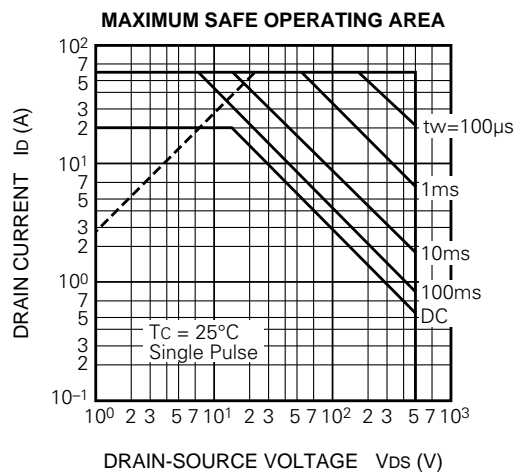
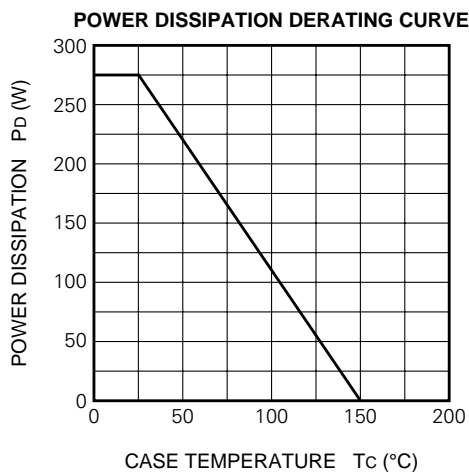

OUTPUT CHARACTERISTICS (TYPICAL)

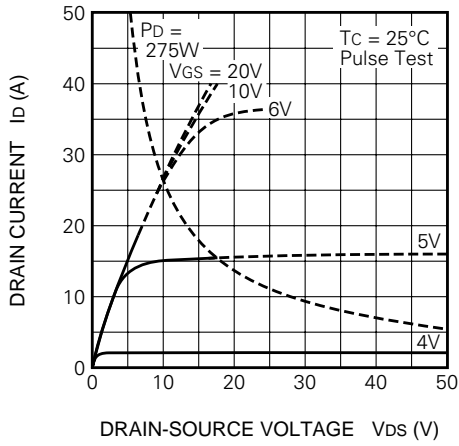

OUTPUT CHARACTERISTICS (TYPICAL)

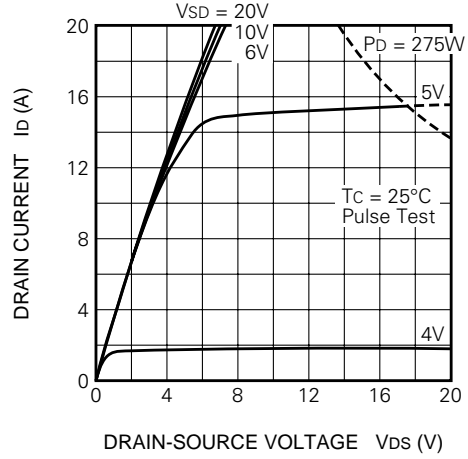

ON-STATE VOLTAGE VS. GATE-SOURCE VOLTAGE (TYPICAL)

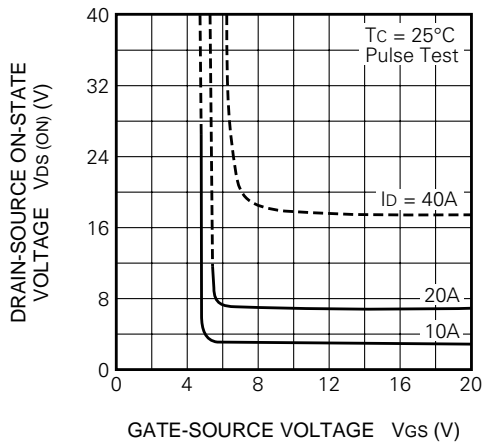

ON-STATE RESISTANCE VS. DRAIN CURRENT (TYPICAL)

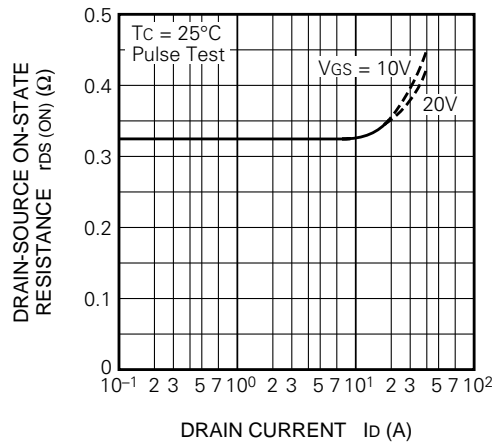

TRANSFER CHARACTERISTICS (TYPICAL)

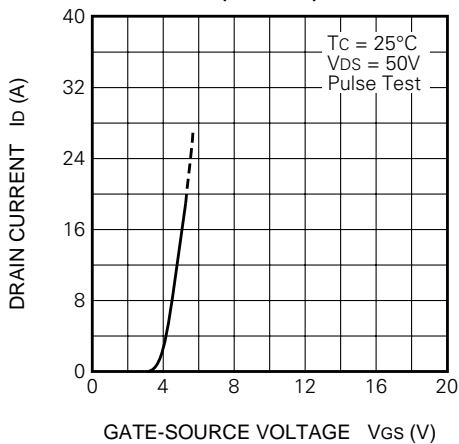

FORWARD TRANSFER ADMITTANCE VS. DRAIN CURRENT (TYPICAL)

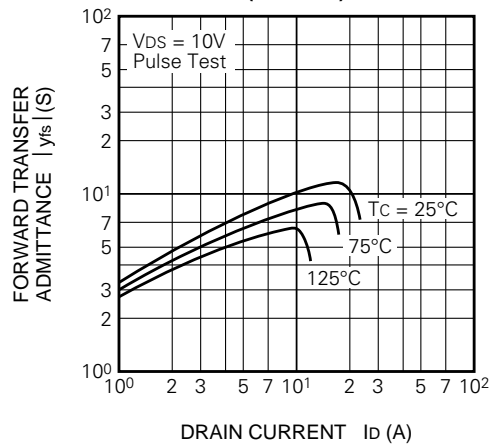

CAPACITANCE VS. DRAIN-SOURCE VOLTAGE (TYPICAL)

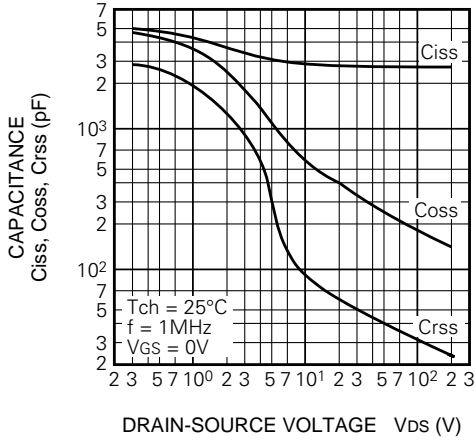

SWITCHING CHARACTERISTICS (TYPICAL)

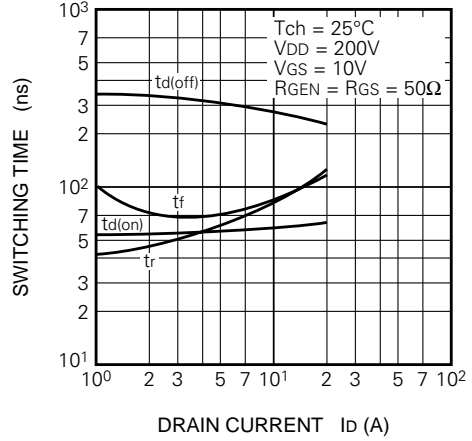

GATE-SOURCE VOLTAGE VS. GATE CHARGE (TYPICAL)

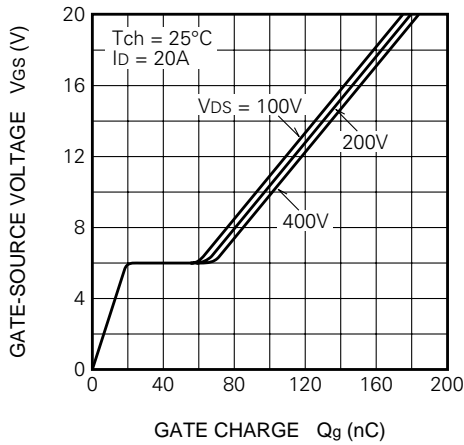

SOURCE-DRAIN DIODE FORWARD CHARACTERISTICS (TYPICAL)

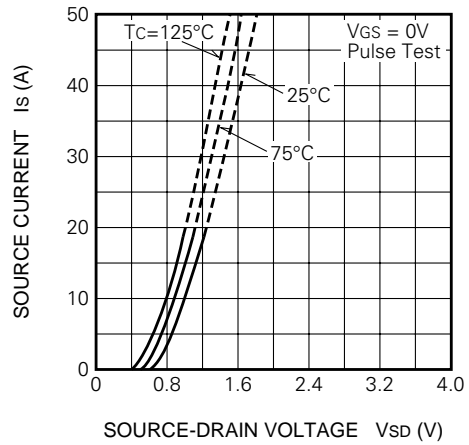

ON-STATE RESISTANCE VS. CHANNEL TEMPERATURE (TYPICAL)

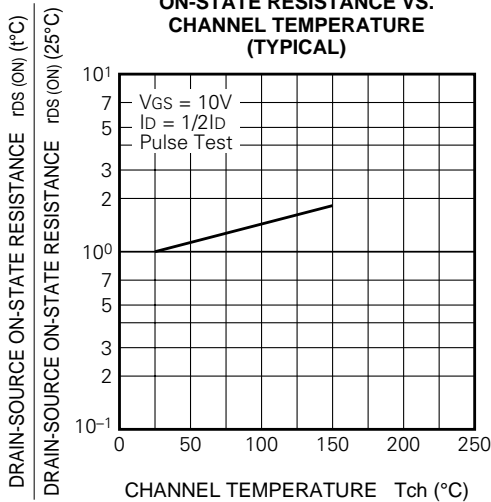

THRESHOLD VOLTAGE VS. CHANNEL TEMPERATURE (TYPICAL)

