

Compact total length of travel +15mm and improved operating feel

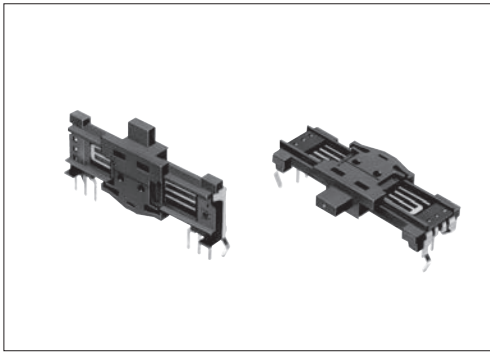

■ Typical Specifications



Items	Specifications
Total resistance tolerance	±20%
Maximum operating voltage	Please see P.402
Operating force	0.6 ^{+0.5} _{-0.4} N
Operating life	10,000 cycles
Operating temperature range	-25°C to +70°C

■ Product Line

Number of resistor elements	Direction of lever	Travel (mm)	Lever types	Length of lever (L1) (mm)	Total resistance (kΩ)	Resistance taper	Center detent	Tap	Minimum order unit (pcs.)		Products No.	Drawing No.					
									Japan	Export							
Single-unit	Vertical	15	C	9.5	100	1B	With	Without	2,900	5,800	RS15H113CA05	1					
					50		Without				RS15H111CA04						
					100		With				RS15H113C001						
		20		50	Without		RS20H113C008		2								
				100	With		RS20H111C009										
				15A	Without		RS30H111A00D										
	Horizontal	15	20	A	4.5	100	1B		Without	2,750	5,500	RS15H11AA04M	7				
						10						15A		RS15H11AA008			
						250						1B		RS15H11AA00G			
						10								With	RS20H11AA02T		
						5								Without	RS20H11CA00B		
		30				50	1B		Without			RS20H11AA01U	8				
						10						Without		RS20H11AA015			
						50						Without		RS30H11AA009			
						200						Without		RS30H11AA00G			
						5						Without		RS30H11AAA0B			
Dual-unit	Vertical	15	A	9.5	10	15A	With	Without	2,900	5,800	RS15H121A009	4					
					20						100		1B	Without	2,500	5,000	RS20H123A01C
																	30
	Horizontal	15		4.5	50	1B	Without		2,750	5,500	RS15H12AA00F	10					
											20		250	3B	1,980	3,960	RS15H12AA009
																	30
	RS30H12AA003	12															

Note
Other varieties are also available. Refer to "Other Specifications" (P.402).

Refer to P.402 for other specifications.
Refer to P.402 for details of lever types.
Refer to P.403 for ordering products not listed.
Refer to P.426 for soldering conditions.

■ Packing Specifications

Tray

Travel (mm)	Direction of lever	Number of packages (pcs.)		Export package measurements (mm)
		1 case /Japan	1 case /export packing	
15	Vertical	2,900	5,800	378×514×512
	Horizontal	2,750	5,500	374×508×408
20	Vertical	2,500	5,000	378×514×512
	Horizontal	2,750	5,500	374×508×408
30	Vertical	2,000	4,000	378×514×512
	Horizontal	1,980	3,960	374×508×408

■ Dimensions

Unit:mm

No.	Style	PC board mounting hole dimensions (Viewed from mounting side)			
1	<table border="1" style="margin-left: auto; margin-right: auto;"> <tr> <td>L_1</td> <td>9.5</td> <td>14.5</td> </tr> </table>	L_1	9.5	14.5	<p>L : Lug terminal</p>
L_1	9.5	14.5			
2		<p>L : Lug terminal</p>			
3		<p>L : Lug terminal</p>			

The length of Lever (L_1) can be customized. Refer to P.402 for details.

■ Dimensions

Unit:mm

No.	Style	PC board mounting hole dimensions (Viewed from mounting side)
4		
5		
6		
7		
8		

■ Dimensions

Unit:mm

No.	Style	PC board mounting hole dimensions (Viewed from mounting side)
9		
10		
11		
12		

The length of Lever (L₁) can be customized. Refer to P.402 for details.

Rotary Potentiometers
 Slide Potentiometers
 General-use
 Mixer

Slim Slide™ (Slim 4) / Other Specifications

In addition to the products listed, we can accommodate the follow specifications.

Travel Distance Variety

Travel (mm)	15	20	30
-------------	----	----	----

Total Resistance Variety

Total resistance (k Ω)	5	10	20	50	100	200	250
------------------------	---	----	----	----	-----	-----	-----

Resistance Taper

Resistance taper	15A	1B	3B
------------------	-----	----	----

Note

Also compatible to DC (10V DC). (Excluding tapped types)

Rated Power

Travel	Resistance taper	
	15A	1B, 3B
15mm	0.012W	0.025W
20mm	0.025W	0.05W
30mm	0.05W	0.1W

Maximum Operating Voltage

Travel	Resistance taper	
	15A	1B, 3B
15mm	50V AC, 10V DC	100V AC, 10V DC
20mm		
30mm	150V AC, 10V DC	200V AC, 10V DC

Terminal Layout / Circuit Diagram (Viewed from the Mounting Side)

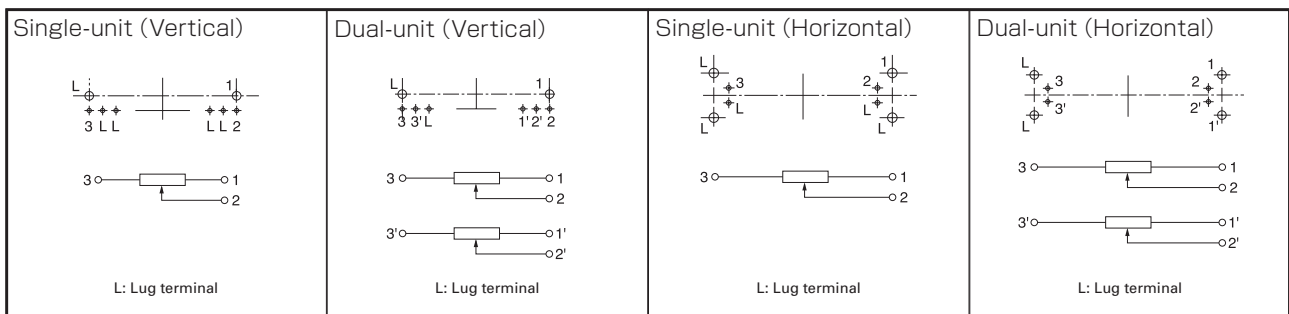

Lever Types

Configuration code	A		C		D	
	4.5	9.5	9.5	14.5	9.5	14.5
Dimensions						
Length L ₁	4.5	9.5	9.5	14.5	9.5	14.5

Corresponding Specification

Tap	Available, (Only the center-positioned)
-----	--

Notes

- The color of the D-type lever is black. Please specify the required color for markers from red, green, orange and white.
- Marked are specifications recommended by Alps.

When ordering product varieties that are not listed, specify referring to the examples below.

Sample Part Number

R S 3 0 H 1 1 1 - A 0 9 5 - B 1 0 3

Travel (mm)
 15, 20, 30

Number of resistor elements

Single-unit	1
Dual-unit	2

Direction of lever and presence of center detent

Code	Direction of lever	Center detent
1	Vertical	Without
3		With
A	Horizontal	Without
C		With

Lever types

Code
A
C
D

Length of lever

Code	Length L ₁ (mm)
045	4.5
095	9.5
145	14.5

Resistance taper

Code	Resistance taper
A	15A
B	1B
V	3B

B: For tone & general V: For vol.

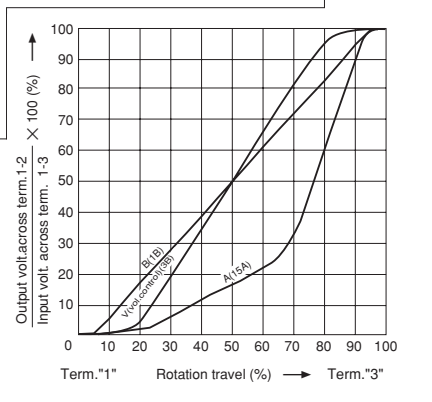









Total resistance

Code	Total resistance (k Ω)	Code	Total resistance (k Ω)
502	5	104	100
103	10	204	200
203	20	254	250
503	50	—	—

Note
Marked are specifications recommended by Alps.

Slide Potentiometers

List of Varieties

Type		Standard Type			Master Type	
Series	Super Slide™	Slim Slide™ (Slim4)		Compact Reflow Type	K Fader	
	RS □□ 1	RS □□ H		RS08U	RS □□ K	
	Single-unit/Dual-unit	Single-unit/Dual-unit		Single-unit	Single-unit/Dual-unit	
Photo						
Travel (mm)		15, 20, 30, 45, 60	15, 20, 30		8	60, 100
Direction of lever		Vertical		Horizontal	Vertical Horizontal	Vertical
Lever material		Metal / Resin	Resin			Metal
Operating temperature range		-25°C to +70°C			-10°C to +70°C	-10°C to +60°C
Operating life		15,000 cycles	10,000 cycles			100,000 cycles (Standard) 300,000 cycles (CP)
Available for automotive use		○	—	—	—	—
Life cycle (availability)						
Electrical performance	Total resistance (k Ω)	10, 20, 50, 100, 200	5, 10, 20, 50, 100, 200, 250		10	10, 50, 100(Standard) 10 (CP)
	Resistance taper	10A, 15A, 1B, 3B, 4B	15A, 1B, 3B		1B	15A, 1B
	Rated Power	Please see P.395	Please see P.402		0.025W	0.25W
	Insulation resistance	100MΩ min. 250V DC	Dual-unit: 100MΩ min. 250V DC		100MΩ min. 100V DC	100MΩ min. 250V DC
	Voltage proof	300V AC for 1 minute	Dual-unit: 300V AC for 1 minute		100V AC for 1 minute	250V AC for 1 minute
	Center-taps	Without / With			Without	
Mechanical performance	Operating force	0.3 to 2.5N	0.6 ^{+0.5} _{-0.4} N		0.17±0.15N	Please see P.408
	Center detent	Without / With			Without	
	Stopper strength	50N	30N		5N	100N
	Lever push-pull strength	50N	30N		5N	100N
	Lever wobble (mm) ※ Both sides	$\frac{2(2 \times L)}{20}$	1.6 max.		—	$\frac{2(2 \times L)}{25}$
	Detent slip-out force	Operating force + (0.2 to 2N)	Operating force +0.3 ^{+0.5} _{-0.25} N		—	—
	Lever deviation (mm) ※ One side	0.5 max.	—	—	—	0.5 max.
Terminal style		Insertion			Reflow	Lead (Standard) Connector (CP)
Page		389	398		404	405

Slide Potentiometers Soldering Conditions	426
Potentiometer Cautions	427
Potentiometers Measurement and Test Methods	429
Potentiometers Resistance Taper	431

Notes

- "L" in the "Lever Wobble" column of the above table indicates the length of lever.
- RS □□
 □□ indicates travel.
- Indicates applicability to some products in the series.

Reference for Manual Soldering

Series	Tip temperature	Duration of Soldering time	No. of solders
RS□□1, RS□□H, RS08U, RS□□K (Standard), RS□□N, RS□□N11S, RS6011□P, RS□□N1□M, RSA0K1□V (Motor terminal)	350°C max.	3s max.	1 time

Reference for Dip Soldering

Series	Preheating		Dip soldering		Number of soldering
	Soldering surface temperature	Heating time	Soldering temperature	Soldering time	
RS□□1, RS□□H, RS□□N, RS□□N11S, RS6011□P, RS□□N1□M	100°C max.	1 min. max.	260°C	5s max.	1 time

Example of Reflow Soldering Condition

Temperature profile

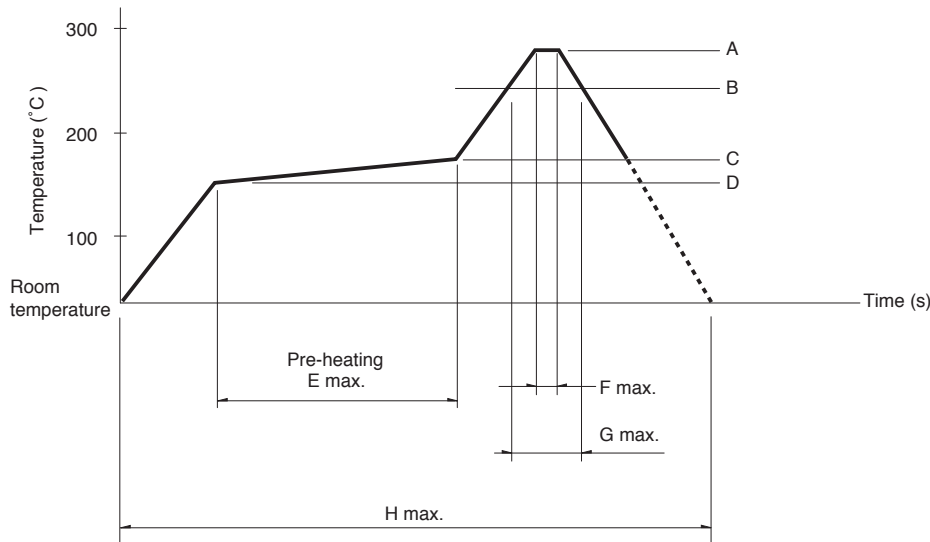

Series	A	B	C	D	E	F	G	H	No. of reflows
RS08U	250°C	200°C	150°C	150°C	2 min.	3s	40s	4 min.	1 time

Notes

1. When using an infrared reflow oven, solder may sometimes not be applied. Be sure to use a hot air reflow oven or a type that uses infrared rays in combination with hot air.
2. The temperatures given above are the maximum temperatures at the terminals of the potentiometer when employing a hot air reflow method. The temperature of the PC board and the surface temperature of the potentiometer may vary greatly depending on the PC board material, its size and thickness. Ensure that the surface temperature of the potentiometer does not rise to 250°C or greater.
3. Conditions vary to some extent depending on the type of reflow bath used. Be sure to give due consideration to this prior to use.