

N-channel Enhanced mode TO-220 MOSFET

Features

- High ruggedness
- Low $R_{DS(ON)}$ (Typ 2.8mΩ)@ $V_{GS}=10V$
(Typ 3.7mΩ)@ $V_{GS}=4.5V$
- Low Gate Charge (Typ 120nC)
- Improved dv/dt Capability
- 100% Avalanche Tested
- Application: Power Supply, LED Boost

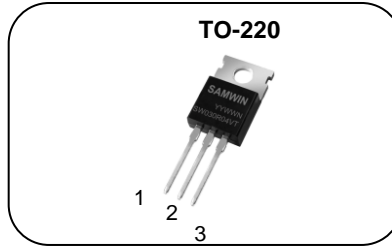

1. Gate 2. Drain 3. Source

BV_{DSS}	: 40V
I_D	: 130A
$R_{DS(ON)}$: 2.8mΩ@ $V_{GS}=10V$ 3.7mΩ@ $V_{GS}=4.5V$

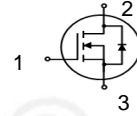

General Description

This power MOSFET is produced with advanced technology of SAMWIN. This technology enable the power MOSFET to have better characteristics, including fast switching time, low on resistance, low gate charge and especially excellent avalanche characteristics.



Order Codes

Item	Sales Type	Marking	Package	Packaging
1	SW P 030R04VT	SW030R04VT	TO-220	TUBE

Absolute maximum ratings

Symbol	Parameter	Value	Unit
V_{DSS}	Drain to source voltage	40	V
I_D	Continuous drain current (@ $T_C=25^{\circ}C$)	130*	A
	Continuous drain current (@ $T_C=100^{\circ}C$)	82*	A
I_{DM}	Drain current pulsed (note 1)	520	A
V_{GS}	Gate to source voltage	±20	V
E_{AS}	Single pulsed avalanche energy (note 2)	826	mJ
E_{AR}	Repetitive avalanche energy (note 1)	49	mJ
dv/dt	Peak diode recovery dv/dt (note 3)	5	V/ns
P_D	Total power dissipation (@ $T_C=25^{\circ}C$)	121	W
	Derating factor above 25°C	0.98	W/°C
T_{STG}, T_J	Operating junction temperature & storage temperature	-55 ~ + 150	°C
T_L	Maximum lead temperature for soldering purpose, 1/8 from case for 5 seconds.	300	°C

*. Drain current is limited by junction temperature.

Thermal characteristics

Symbol	Parameter	Value	Unit
R_{thjc}	Thermal resistance, Junction to case	1.03	°C/W
R_{thja}	Thermal resistance, Junction to ambient	52	°C/W

Electrical characteristic ($T_c = 25^\circ\text{C}$ unless otherwise specified)

Symbol	Parameter	Test conditions	Min.	Typ.	Max.	Unit
Off characteristics						
BV_{DSS}	Drain to source breakdown voltage	$V_{GS}=0V, I_D=250\mu A$	40			V
$\Delta BV_{DSS} / \Delta T_J$	Breakdown voltage temperature coefficient	$I_D=250\mu A$, referenced to 25°C		0.02		$V/^\circ\text{C}$
I_{DSS}	Drain to source leakage current	$V_{DS}=40V, V_{GS}=0V$			1	μA
		$V_{DS}=32V, T_c=125^\circ\text{C}$			50	μA
I_{GSS}	Gate to source leakage current, forward	$V_{GS}=20V, V_{DS}=0V$			100	nA
	Gate to source leakage current, reverse	$V_{GS}=-20V, V_{DS}=0V$			-100	nA
On characteristics						
$V_{GS(TH)}$	Gate threshold voltage	$V_{DS}=V_{GS}, I_D=250\mu A$	1		3	V
$R_{DS(ON)}$	Drain to source on state resistance	$V_{GS}=10V, I_D=130A$		2.9	3.6	$m\Omega$
		$V_{GS}=10V, I_D=65A$		2.8	3.5	$m\Omega$
		$V_{GS}=4.5V, I_D=65A$		3.7	4.6	$m\Omega$
G_{fs}	Forward transconductance	$V_{DS}=10V, I_D=30A$		140		S
Dynamic characteristics						
C_{iss}	Input capacitance	$V_{GS}=0V, V_{DS}=20V, f=1\text{MHz}$		5350		pF
C_{oss}	Output capacitance			686		
C_{riss}	Reverse transfer capacitance			644		
$t_{d(on)}$	Turn on delay time	$V_{DS}=20V, I_D=30A, R_G=25\Omega, V_{GS}=10V$ (note 4,5)		36		ns
t_r	Rising time			123		
$t_{d(off)}$	Turn off delay time			396		
t_f	Fall time			210		
Q_g	Total gate charge	$V_{DS}=32V, V_{GS}=10V, I_D=30A$ (note 4,5)		120		nC
Q_{gs}	Gate-source charge			17		
Q_{gd}	Gate-drain charge			35		
R_g	Gate resistance		$V_{DS}=0V$, Scan F mode		1.3	

Source to drain diode ratings characteristics

Symbol	Parameter	Test conditions	Min.	Typ.	Max.	Unit
I_S	Continuous source current	Integral reverse p-n Junction diode in the MOSFET			130	A
I_{SM}	Pulsed source current				520	A
V_{SD}	Diode forward voltage drop.	$I_S=30A, V_{GS}=0V$			1.4	V
t_{rr}	Reverse recovery time	$I_S=30A, V_{GS}=0V,$ $di_f/dt=100A/\mu s$		29		ns
Q_{rr}	Reverse recovery charge				19	

※. Notes

1. Repeattive rating : pulse width limited by junction temperature.
2. $L = 1.84\text{mH}, I_{AS} = 30A, V_{DD} = 30V, R_G = 25\Omega$, Starting $T_J = 25^\circ\text{C}$
3. $I_{SD} \leq 30A, di/dt = 100A/\mu s, V_{DD} \leq BV_{DSS}$, Starting $T_J = 25^\circ\text{C}$
4. Pulse Test : Pulse Width $\leq 300\mu s$, duty cycle $\leq 2\%$.
5. Essentially independent of operating temperature.

Fig. 1. On-state characteristics

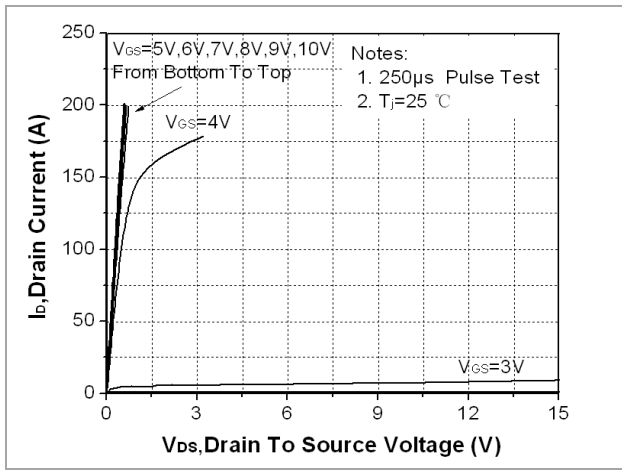

Fig. 2. On-resistance variation vs. drain current and gate voltage

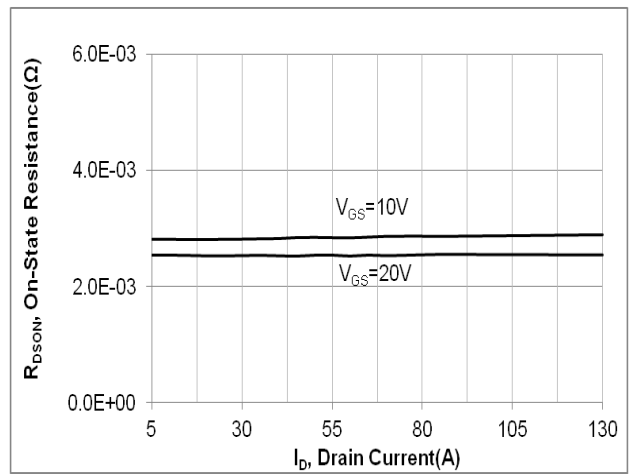

Fig. 3. Gate charge characteristics

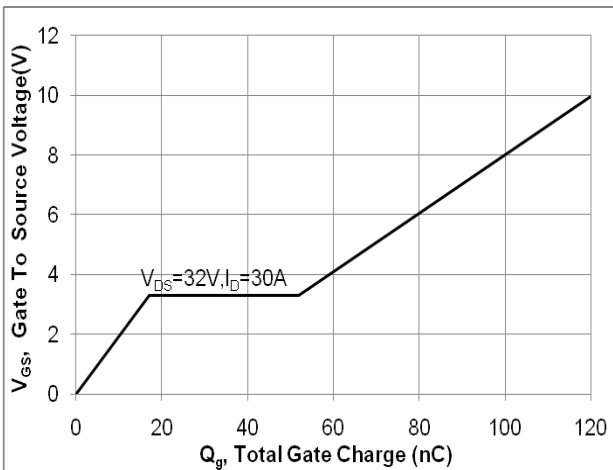

Fig. 4. On-state current vs. diode forward voltage

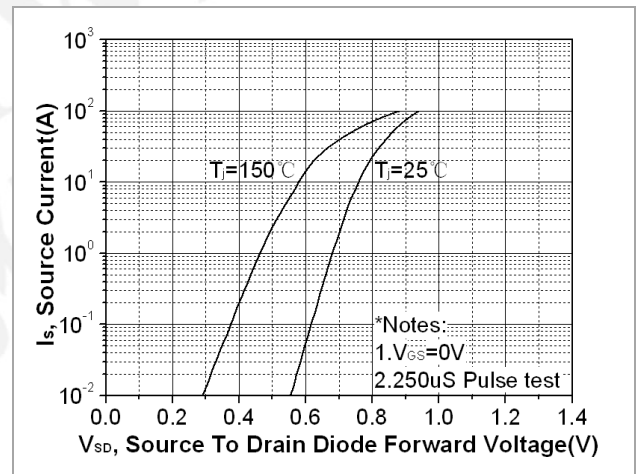

Fig 5. Breakdown voltage variation vs. junction temperature

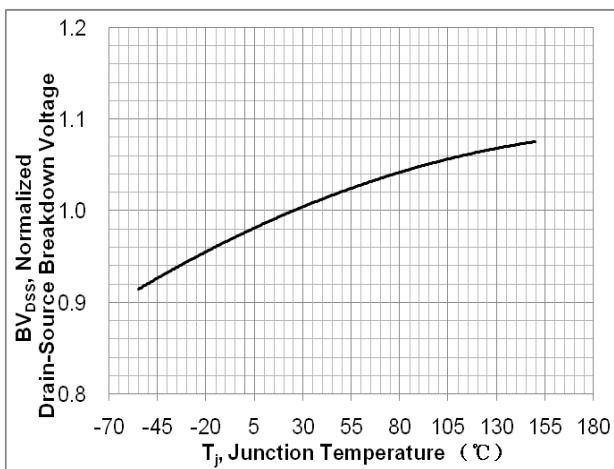

Fig. 6. On-resistance variation vs. junction temperature

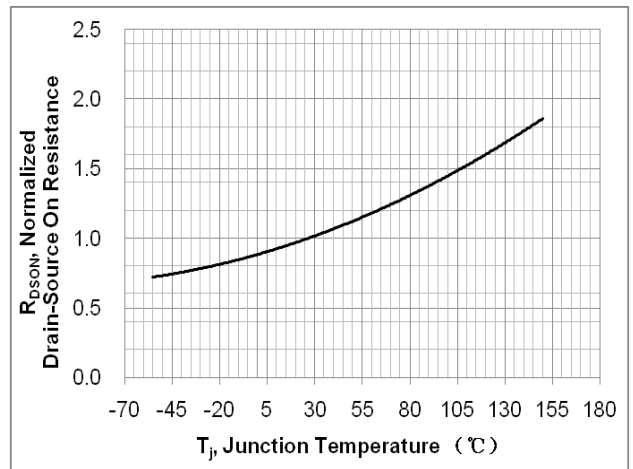

Fig. 7. Maximum safe operating area

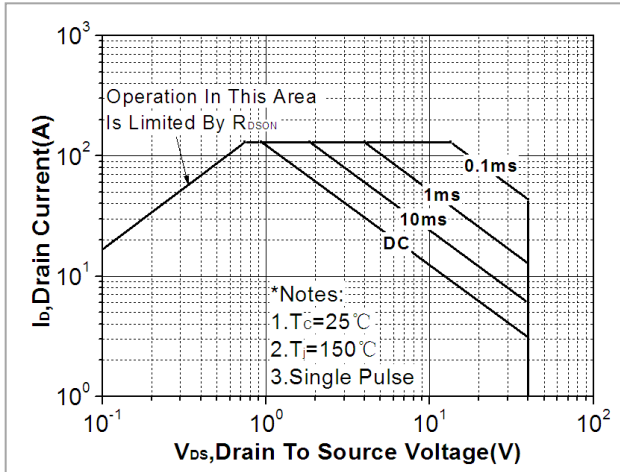

Fig. 8. Capacitance Characteristics

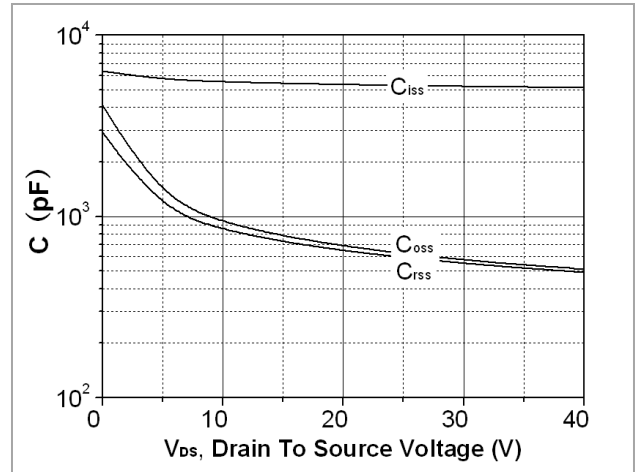

Fig. 9. Transient thermal response curve

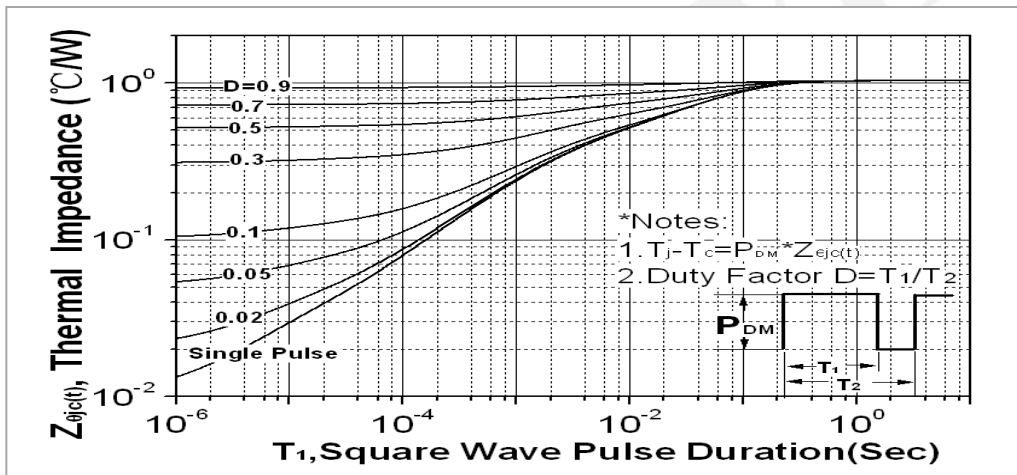

Fig. 10. Gate charge test circuit & waveform

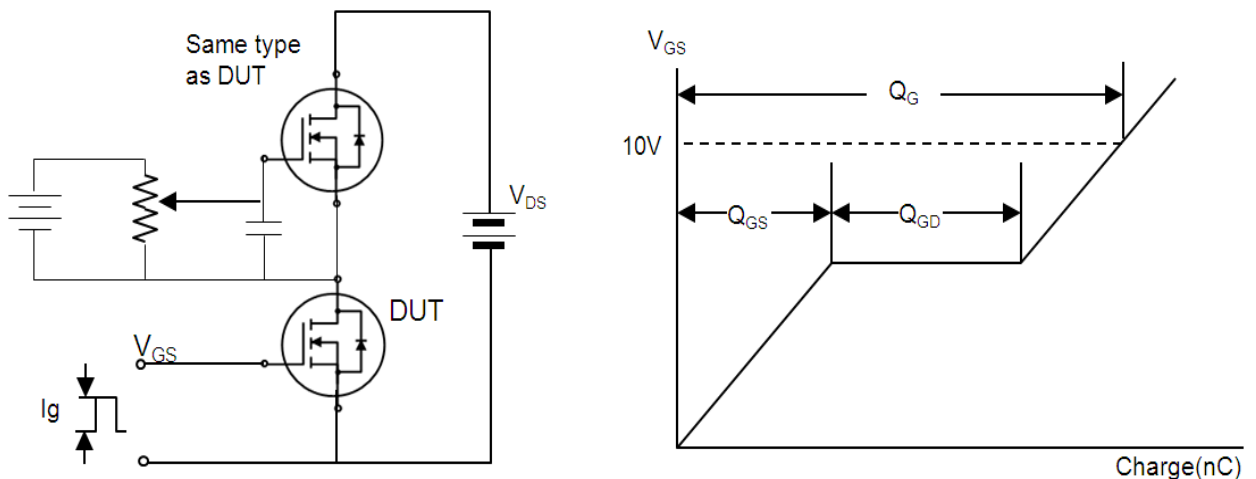

Fig. 11. Switching time test circuit & waveform

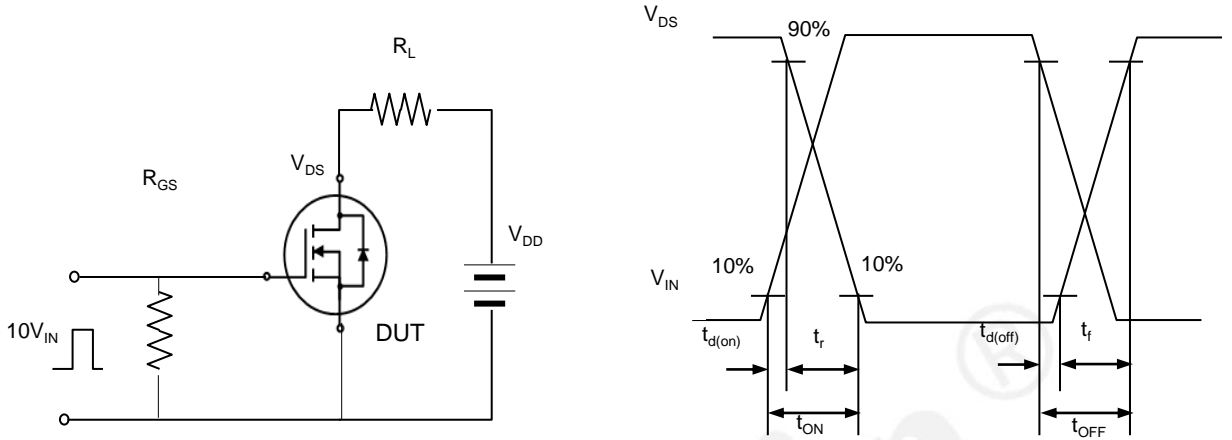

Fig. 12. Unclamped Inductive switching test circuit & waveform

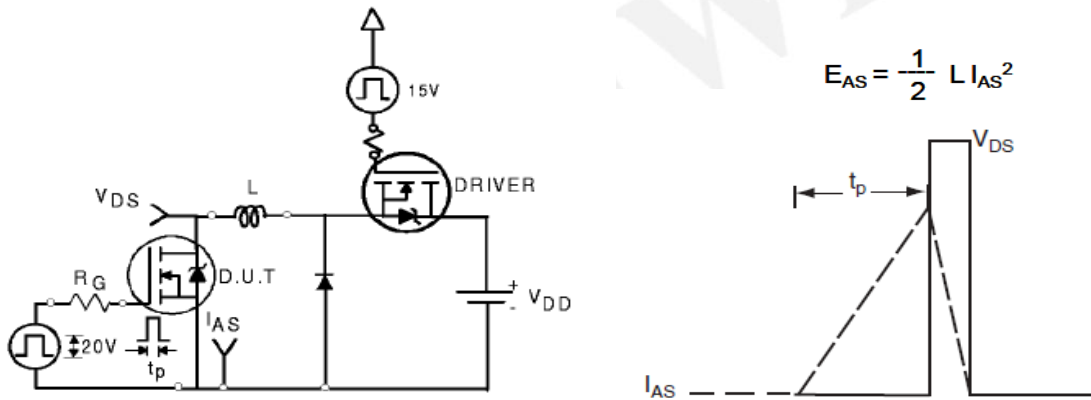
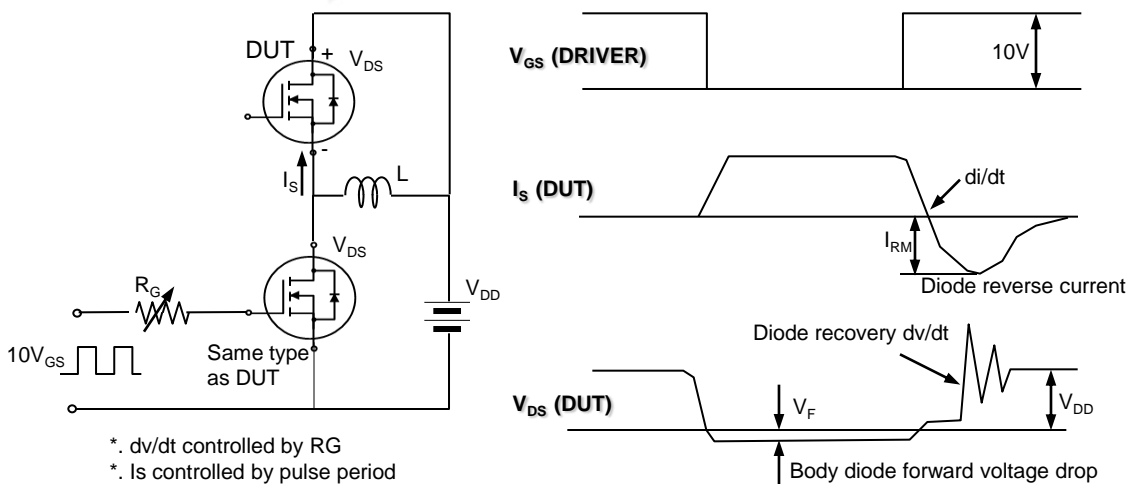

Fig. 13. Peak diode recovery dv/dt test circuit & waveform



Samwin®
内部保密

DISCLAIMER

* All the data & curve in this document was tested in XI' AN SEMIPOWER TESTING & APPLICATION CENTER.

* This product has passed the PCT,TC,HTRB,HTGB,HAST,PC and Solderdunk reliability testing.

* Qualification standards can also be found on the Web site (<http://www.semipower.com.cn>)

* Suggestions for improvement are appreciated, Please send your suggestions to samwin@samwinsemi.com

