

REVISION RECORD

REVISION	REVISION DATE	PAGE	CONTENTS
VER1.0	2013-012-09		FIRST ISSUED

※ **CONTENTS**

- 1.0 GENERAL SPECIFICATION
- 2.0 BLOCK DIAGRAM
- 3.0 PIN ASSIGNMENT
- 4.0 OPERATING SPECIFICATIONS
- 5.0 OPTICAL CHARACTERISTICS
- 6.0 RELIABILITY TEST
- 7.0 PRECAUTION FOR USING LCM
- 8.0 MECHANICAL DIAGRAM
- 9.0 PACKAGE DRAWING
- 10.0 INSPECTION SPECIFICATION

1.0 GENERAL SPECIFICATION

1. Display Format	800RGB*600 DOTS
2. Power Supply	LCD 3.3V/BACKLIGHT 5.0V
3. Overall Module Size	228.4mm(W) x 175.4mm(H) x 13.4mm(T)
4. Active Area(W*H)	211.2mm(W) x 158.4mm(H)
5. Color Configuration	RGB stripe
6. Color Depth	16.7M colors
7. Dot Pitch (W*H)	0.088mm(W) x 0.264mm(H)
8. Viewing Direction	6 O'clock
9. Display mode	Normally white
10. Backlight Options	LED-SIDE(White)
11. Interface	LVDS
12. Operating temperature	-20°C ~ 70°C
14. Storage temperature	-30°C ~ 80°C
13. Power consumption of BL Unit	2.304W(Typ.)
14. Power consumption of BL driving circuit(with BL)	3.072W(Typ.)
15. Power consumption of TFT circuit	0.99W(Typ.)
16. Weight	525g(Typ.)
17. ROHS	ROHS compliant

Note 1: Please refer to mechanical drawing.

2.0 BLOCK DIAGRAM

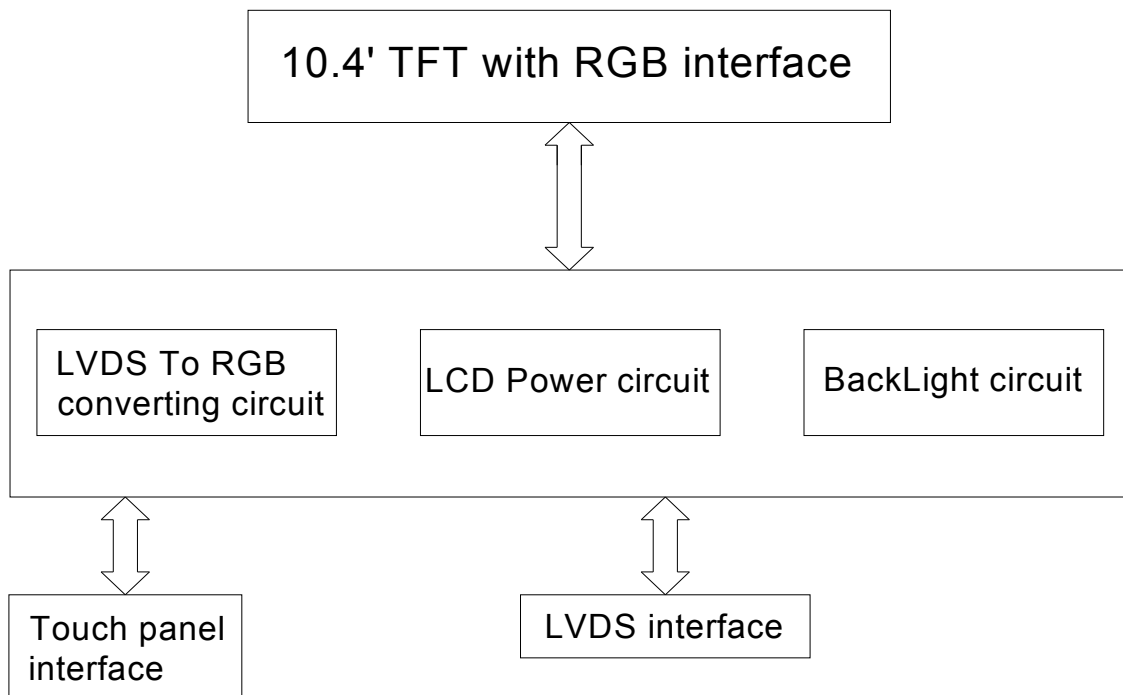

ATM1040L3A-T1(AZ DISPLAYS) TFT MODULE VER1.0

3.0 PIN ASSIGNMENT

Connector on LCM : HIROSE DF19G-20P-1H or compatible, mating with HIROSE DF19-20S-1C or compatible

Pin No.	Symbol	Function
1	TX0-	Negative LVDS differential data input(G0,R5-R0)*3
2	TX0+	Positive LVDS differential data input(G0,R5-R0)*3
3	VSS*1	Ground
4	TX1-	Negative LVDS differential data input(B1,B0,G5-G1)*3
5	TX1+	Positive LVDS differential data input(B1,B0,G5-G1)*3
6	VSS*1	Ground
7	TX2-	Negative LVDS differential data input(DE, VS,HS,B5-B2)*3
8	TX2+	Positive LVDS differential data input(DE, VS,HS,B5-B2)*3
9	VSS*1	Ground
10	CLK-	Clock Signal(-)
11	CLK+	Clock signal(+)
12	VSS*1	Ground
13	TX3-	Negative LVDS differential data input(B7,B6,G7,G6,R7,R6)*3 *4
14	TX3+	Positive LVDS differential data input(B7,B6,G7,G6,R7,R6)*3 *4
15	VDD	+3.3V power supply for logic and LCM
16	VDD	+3.3V power supply for logic and LCM
17	BL_DV+	Backlight driving circuit power in(+5.0V)
18	BL_DV-	Ground of backlight driving circuit, seperated from system ground
19	PWM	Backlight On/Off/Dimming control(PWM:100~1000Hz, 0~100%)
20	VSS*1	Ground

NOTE 1) PLEASE CONNECT VSS PIN TO GROUND. DON'T USE IT AS NO-CONNECT NOR CONNECTION WITH HIGH IMPEDANCE.

NOTE 2) PLEASE CONNECT NC PIN TO NOTHING. DON'T CONNECT IT TO GROUND NOR TO OTHER SIGNAL INPUT.

NOTE 3) REFER TO NEXT PAGE.

ATM1040L3A-T1(AZ DISPLAYS) TFT MODULE VER1.0

RECOMMENDED TRANSMITTER(DS90C386)TO ATM1040L3A INTERFACE ASSIGNMENT

Device Pin Name	Signal	Signal Pattern	Signal Frequency
TxCLK IN/RxCLK OUT	Dot Clk		f
TxIN0/RxOUT0	R0		f/16
TxIN1/RxOUT1	R1		f/8
TxIN2/RxOUT2	R2		f/4
TxIN3/RxOUT3	R3		f/2
TxIN4/RxOUT4	R4		Steady State, Low
TxIN5/RxOUT5	R7		Steady State, Low
TxIN6/RxOUT6	R5		Steady State, Low
TxIN7/RxOUT7	G0		Steady State, Low
TxIN8/RxOUT8	G1		f/16
TxIN9/RxOUT9	G2		f/8
TxIN10/RxOUT10	G6		f/4
TxIN11/RxOUT11	G7		f/2
TxIN12/RxOUT12	G3		Steady State, Low
TxIN13/RxOUT13	G4		Steady State, Low
TxIN14/RxOUT14	G5		Steady State, Low
TxIN15/RxOUT15	B0		Steady State, Low
TxIN16/RxOUT16	B6		f/16
TxIN17/RxOUT17	B7		f/8
TxIN18/RxOUT18	B1		f/4
TxIN19/RxOUT19	B2		f/2
TxIN20/RxOUT20	B3		Steady State, Low
TxIN21/RxOUT21	B4		Steady State, Low
TxIN22/RxOUT22	B5		Steady State, Low
TxIN23/RxOUT23	RES		Steady State, Low
TxIN24/RxOUT24	HSYNC		Steady State, High
TxIN25/RxOUT25	VSYNC		Steady State, High
TxIN26/RxOUT26	EN		Steady State, High
TxIN27/RxOUT27	R6		Steady State, High

Grayscale" Test Pattern (DS90CF386) (Notes I , II ,III)

I . The 16 grayscale test pattern tests device power consumption for a "typical" LCD display pattern. The test pattern approximates signal switching needed to produce groups of 16 vertical stripes across the display.

II . falling edge data strobe (TxCLK IN/RxCLK OUT).

III. Recommended pin to signal mapping. Customer may choose to define differently.

ATM1040L3A-T1(AZ DISPLAYS) TFT MODULE VER1.0

Touch Panel Section

Recommended connector: SFW04R-1STAE1LF or compatible(4PINS,Pitch = 1.0mm, bottom side contact)

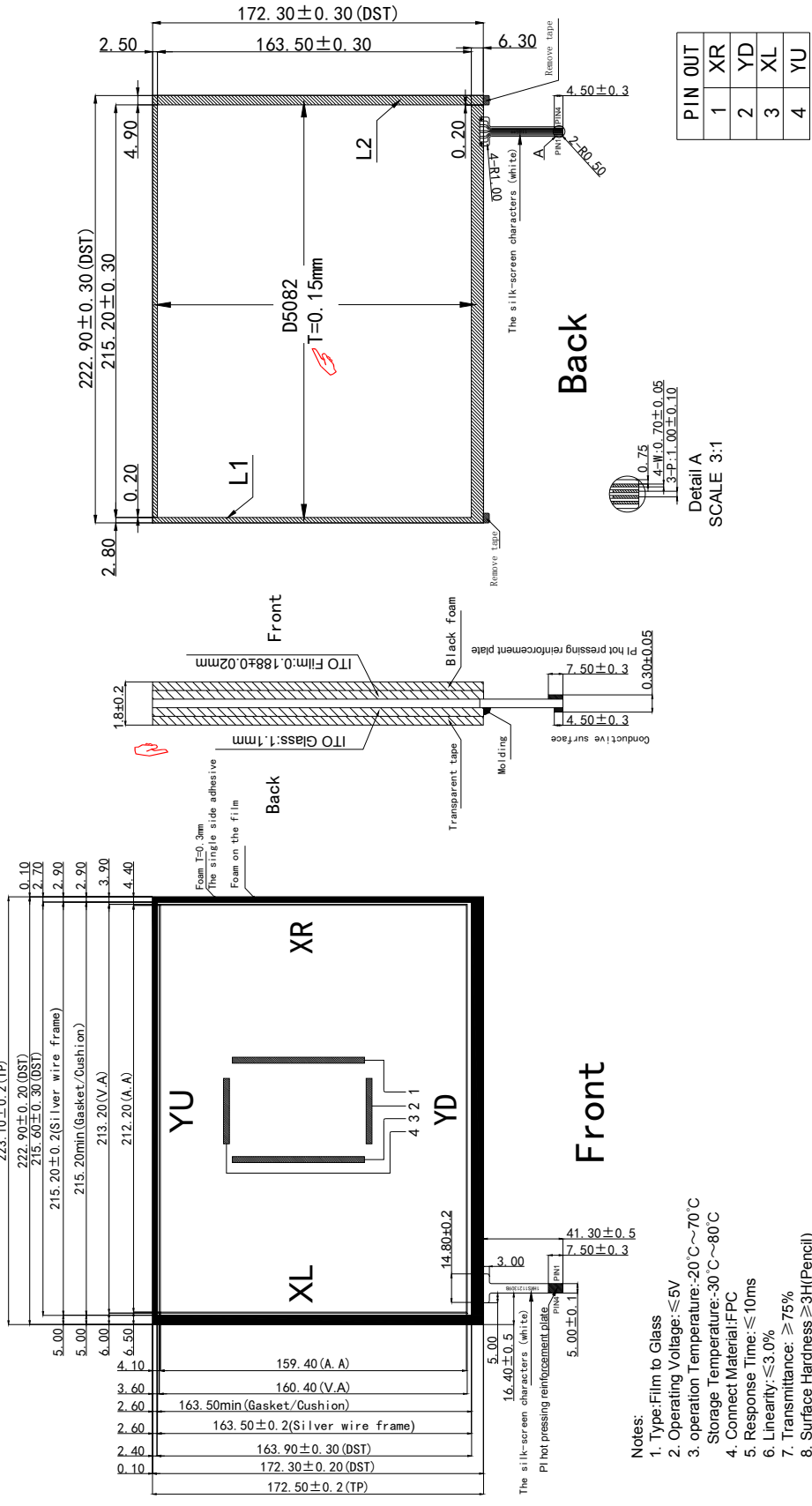

- Notes:
1. Type: Film to Glass
 2. Operating Voltage: $\leq 5V$
 3. operation Temperature: $-20^{\circ}C \sim 70^{\circ}C$
Storage Temperature: $-30^{\circ}C \sim 80^{\circ}C$
 4. Connect Material: FPC
 5. Response Time: $\leq 10ms$
 6. Linearity: $\leq 3.0\%$
 7. Transmittance: $\geq 75\%$
 8. Surface Hardness $\geq 3H$ (Pencil)
 9. operation force: $\leq 100g$
 10. Resistance:
(Anti-glare Hard & Mate anti-newton ring coating ITO Film): $300 \Omega \sim 850 \Omega$
(Stand ard ITO Glass): $150 \Omega \sim 550 \Omega$
 11. Insulating resistance $> 10M\Omega$, $15V(DC)$
 12. Unspecified Tolerance: ± 0.30
 13. All materials in the drawing coincide with the ROHS

4.0 Operating Specification

4.1 ABSOLUTE MAXIMUM RATINGS

Item	Symbol	Min	Typ	Max	Unit
Operating temperature	Top	-20	-	70	°C
Storage temperature	Tst	-30	-	80	°C
Input voltage	Vin	Vss-0.3	-	Vdd+0.3	V
Supply voltage for logic	Vdd- Vss	-0.3	-	3.6	V

4.1.1 Typical Operation Conditions

Item	Symbol	Condition	Min	Typ	Max	Unit
Power Supply Voltage	V _{DD}	Ta=25°C	3.0	3.3	3.6	V
Power Supply current	I _{DD}	V _{DD} =3.3V	-	300	-	mA
BL circuit voltage	VLED(PIN17)	Ta=25°C	4.8	5.0	5.2	V
BL circuit current	I _{LED}	V _{LED} =5V		614		mA
Input voltage (high)	V _{ih}	H level	0.7V _{dd}	-	V _{dd}	V
Input voltage (low)	V _{il}	L level	V _{ss}	-	0.3V _{dd}	V

4.1.2 Backlight driving conditions

Item	Symbol	Condition	Min	Typ	Max	Unit	Remark
Backlight Voltage (To LED directly)	V _{BL}	I _{BL} =240mA	-	9.6	10.5	V	Note1
LED life time	--	--	10000	--	--	H	Note2

Note 1: The LED Supply Voltage is defined by the number of LED at Ta=25°C and I_{BL}=240mA.

Note 2: The "LED life time" is defined as the module brightness decrease to 50% original brightness at Ta=25°C and I_{BL}=240mA.

4.2 TIMING CHARACTERISTICS

4.2.1 Data Input Format

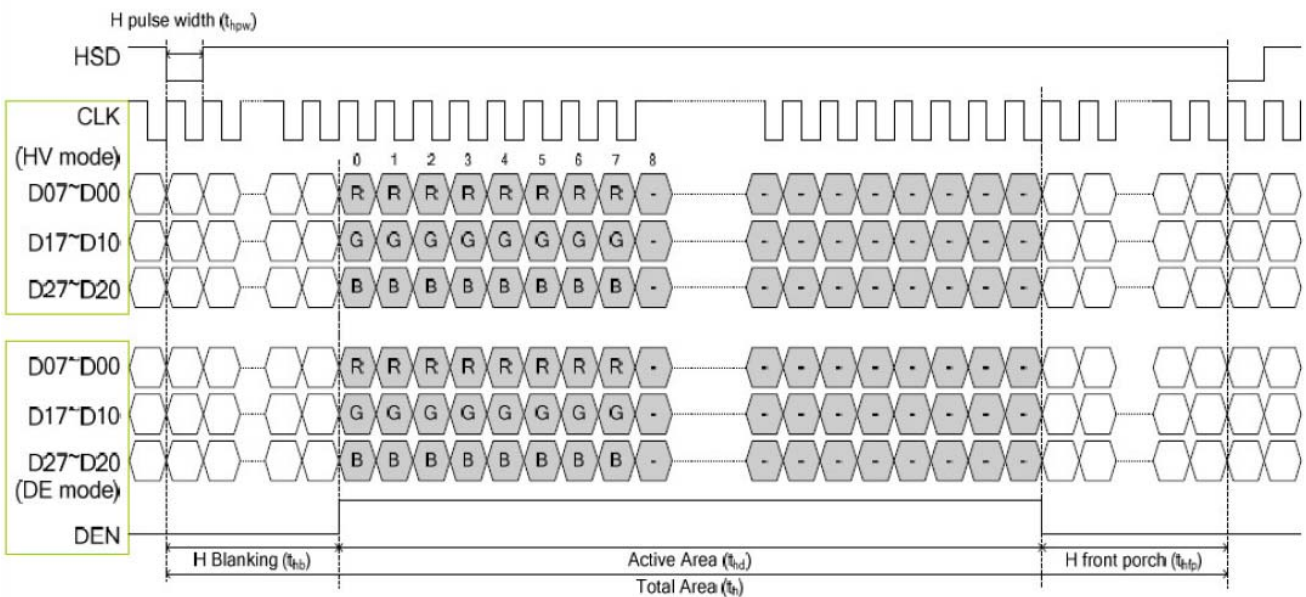
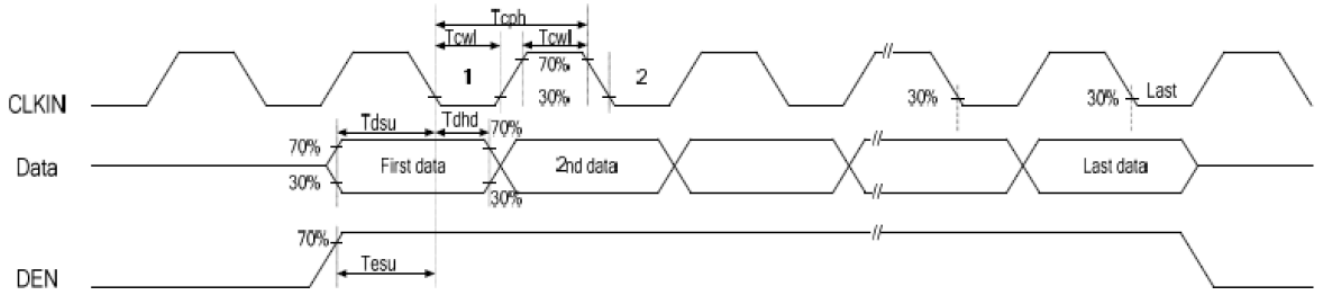

4.2.2 AC Electrical Characteristics

Item	Symbol	Values			Unit	Remark
		Min.	Typ.	Max.		
HS setup time	T_{hst}	8	-	-	Ns	
HS hold time	T_{hhd}	8	-	-	Ns	
VS setup time	T_{vst}	8	-	-	Ns	
VS hold time	T_{vhd}	8	-	-	Ns	
Data setup time	T_{dsu}	8	-	-	Ns	
Data hole time	T_{dhd}	8	-	-	Ns	
DE setup time	T_{esu}	8	-	-	Ns	
DE hole time	T_{ehd}	8	-	-	Ns	
VDD Power On Slew rate	T_{POR}	-	-	20	ms	
RSTB pulse width	T_{Rst}	10	-	-	us	
CLKIN cycle time	T_{coh}	20	-	-	Ns	
CLKIN pulse duty	T_{cwh}	40	50	60	%	
Output stable time	T_{sst}	-	-	6	us	

4.2.3 Timing

Item	Symbol	Values			Unit	Remark
		Min.	Typ.	Max.		
Horizontal Display Area	thd	-	800	-	DCLK	
DCLK Frequency	fclk	-	40	50	MHz	
One Horizontal Line	th	862	1056	1200	DCLK	
HS pulse width	thpw	1	-	40	DCLK	
HS Back Porch(Blanking)	thb	46	46	46	DCLK	
HS Front Porch	thfp	16	210	354	DCLK	

Item	Symbol	Values			Unit	Remark
		Min.	Typ.	Max.		
Vertical Display Area	tvd	-	600	-	TH	
VS period time	tv	624	635	700	TH	
VS pulse width	tvpw	1	-	20	TH	
VS Back Porch(Blanking)	tvb	23	23	23	TH	
VS Front Porch	tvfp	1	12	77	TH	

5.0 OPTICAL CHARACTERISTICS

Item	Symbol	Condition	Min	Typ	Max	Unit	Remarks	Note
Reponse time	Tr	Ta = 25°C	---	10	20	ms	---	3
	Tf		---	15	30	ms	---	3
Luminance	L	I _{BL} =240mA	160	200	--	cd/m2	---	--
Contrast		Ta = 25°C	300	500	---	---	---	4
Viewing angle range	θ	Cr ≥ 10	40	50	---	deg	∅ = 90°	1
			50	60	---	deg	∅ = 270°	1
			60	70	---	deg	∅ = 0°	1
			60	70	---	deg	∅ = 180°	1

Test Conditions:

- I_{BL}=240mA (Backlight current), the ambient temperature is 25°C.
- The test systems refer to Note 2.

Note 1: Definition of viewing angle range

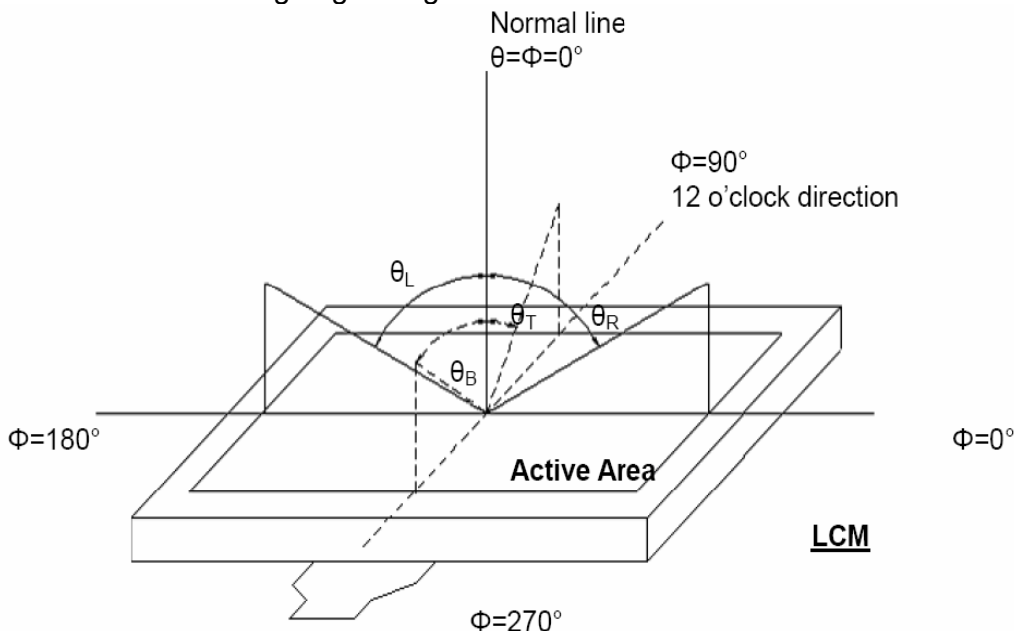

Figure 5.1 Definition of viewing angle.

Note 2: Definition of optical measurement system.

The optical characteristics should be measured in dark room. After 30 minutes operation, the optical properties are measured at the center point of the LCD screen. (Response time is measured by Photo detector TOPCON)

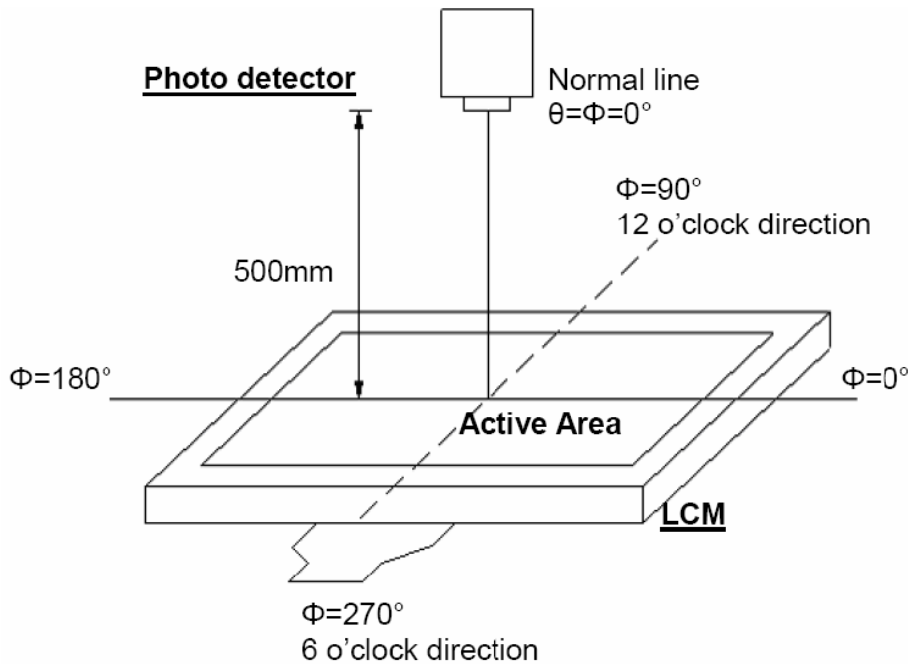

Figure 5.2 Optical measurement system setup

Note 3: Definition of Response time

The response time is defined as the LCD optical switching time interval between "White" state and "Black" state. Rise time (TON) is the time between photo detector output intensity changed from 90% to 10%. And fall time (TOFF) is the time between photo detector output intensity changed from 10% to 90%.

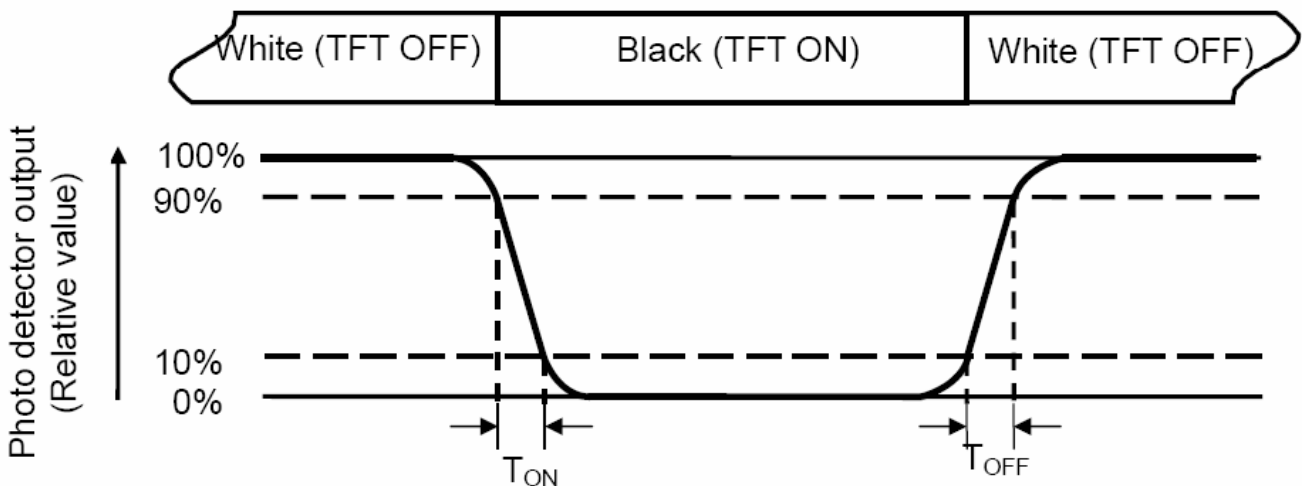
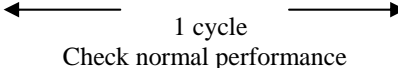

Figure 5.3 Definition of response.

Note 4: Definition of contrast ratio

$$\text{Contrast ratio(CR)} = \frac{\text{Luminance measured when LCD on the "white" state}}{\text{Luminance measured when LCD on the "black" state}}$$

6.0 RELIABILITY TEST

NO	Test Item	Description	Test Condition	Remark	
1	Environmental Test	High temperature storage	Applying the high storage temperature Under normal humidity for a long time Check normal performance	80 °C 96hrs	
2		Low temperature storage	Applying the low storage temperature Under normal humidity for a long time Check normal performance	-30°C 96hrs	
3		High temperature Operation	Apply the electric stress(Volatge and current) Under high temperature for a long time	70 °C 96hrs	Note1
4		Low temperature Operation	Apply the electric stress Under low temperature for a long time	-20°C 96hrs	Note1 Note2
5		High temperature/High Humidity Storage	Apply high temperature and high humidity storage for a long time	90% RH 40°C 96hrs	Note2
6		Temperature Cycle	Apply the low and high temperature cycle -30°C <> 25°C <> 80°C <> 25°C 30min 10min 30min 10min  1 cycle Check normal performance	-30°C/80°C 10 cycle	
7	Mechanical Test	Vibration test(Package state)	Applying vibration to product check normal performance	Freq:10-55Hz Max Acceleration 5G 1cycle time:1min time X.Y.Z direction for 15 mines	
8		Shock test(package state)	Applying shock to product check normal performance	Drop them through 70cm height to strike horizontal plane	
9	Other				

Remark

Note1:Normal operations condition (25°C±5°C).

Note2:Pay attention to keep dewdrops from the module during this test.

7.0 PRECAUTION FOR USING LCM

1. When design the product with this LCD Module, make sure the viewing angle matches to its purpose of usage.
2. As LCD panel is made of glass substrate, Dropping the LCD module or banging it against hard objects may cause cracking or fragmentation. Especially at corners and edges.
3. Although the polarizer of this LCD Module has the anti-glare coating, always be careful not to scratch its surface. Use of a plastic cover is recommended to protect the surface of polarizer.
4. If the LCD module is stored at below specified temperature, the LC material may freeze and be deteriorated. If it is stored at above specified temperature, the molecular orientation of the LC material may change to Liquid state and it may not revert to its original state. Excessive temperature and humidity could cause polarizer peel off or bubble. Therefore, the LCD module should always be stored within specified temperature range.
5. Saliva or water droplets must be wiped off immediately as those may leave stains or cause color changes if remained for a long time. Water vapor will cause corrosion of ITO electrodes.
6. If the surface of LCD panel needs to be cleaned, wipe it swiftly with cotton or other soft cloth. If it is not still clean enough, blow a breath on the surface and wipe again.
7. The module should be driven according to the specified ratings to avoid malfunction and permanent damage.
Applying DC voltage cause a rapid deterioration of LC material. Make sure to apply alternating waveform by continuous application of the M signal. Especially the power ON/OFF sequence should be kept to avoid latchup of driver LSIs and DC charge up to LCD panel.

8. Mechanical Considerations

- a) LCM are assembled and adjusted with a high degree of precision. Avoid excessive shocks and do not make any alterations or modifications. The following should be noted.
- b) Do not tamper in any way with the tabs on the metal frame.
- c) Do not modify the PCB by drilling extra holes, changing its outline, moving its components or modifying its pattern.
- d) Do not touch the elastomer connector; especially insert a backlight panel (for example, EL).
- e) When mounting a LCM makes sure that the PCB is not under any stress such as bending or twisting.
Elastomer contacts are very delicate and missing pixels could result from slight dislocation of any of the elements.
- f) Avoid pressing on the metal bezel, otherwise the elastomer connector could be deformed and lose contact, resulting in missing pixels.

9. Static Electricity

a) Operator

Wear the electrostatics shielded clothes because human body may be statically charged if not wear shielded clothes.

Never touch any of the conductive parts such as the LSI pads; the copper leads on the PCB and the interface

terminals

with any parts of the human body.

b) Equipment

There is a possibility that the static electricity is charged to the equipment, which has a function of peeling or friction

action (ex: conveyer, soldering iron, working table). Earth the equipment through proper resistance

(electrostatic

earth: 1x10⁸ ohm).

Only properly grounded soldering irons should be used.

If an electric screwdriver is used, it should be well grounded and shielded from commutator sparks.

The normal static prevention measures should be observed for work clothes and working benches; for the latter

conductive (rubber) mat is recommended.

c) Floor

Floor is the important part to drain static electricity, which is generated by operators or equipment.

There is a possibility that charged static electricity is not properly drained in case of insulating floor. Set the electrostatic earth (electrostatic earth: 1x10⁸ ohm).

d) Humidity

Proper humidity helps in reducing the chance of generating electrostatic charges. Humidity should be kept over

50%RH.

e) Transportation/storage

The storage materials also need to be anti-static treated because there is a possibility that the human body or storage

materials such as containers may be statically charged by friction or peeling.

The modules should be kept in antistatic bags or other containers resistant to static for storage.

f) Soldering

Solder only to the I/O terminals. Use only soldering irons with proper grounding and no leakage.

Soldering temperature : 280° C ± 10° C

Soldering time: 3 to 4 sec.

Use eutectic solder with resin flux fill.

If flux is used, the LCD surface should be covered to avoid flux spatters. Flux residue should be removed afterwards.

g) Others

The laminator (protective film) is attached on the surface of LCD panel to prevent it from scratches or stains. It should

be peeled off slowly using static eliminator.

Static eliminator should also be installed to the workbench to prevent LCD module from static charge.

10. Operation

a) Driving voltage should be kept within specified range; excess voltage shortens display life.

b) Response time increases with decrease in temperature.

c) Display may turn black or dark blue at temperatures above its operational range; this is (however not pressing on the viewing area) may cause the segments to appear "fractured".

d) Mechanical disturbance during operation (such as pressing on the viewing area) may cause the segments to appear "fractured".

11. If any fluid leaks out of a damaged glass cell, wash off any human part that comes into contact with soap and

water. The toxicity is extremely low but caution should be exercised at all the time.

12. Disassembling the LCD module can cause permanent damage and it should be strictly avoided.
13. LCD retains the display pattern when it is applied for long time (Image retention). To prevent image retention, do not apply the fixed pattern for a long time. Image retention is not a deterioration of LCD. It will be removed after display pattern is changed.
14. Do not use any materials, which emit gas from epoxy resin (hardener for amine) and silicone adhesive agent (dealcohol or deoxym) to prevent discoloration of polarizer due to gas.
15. Avoid the exposure of the module to the direct sunlight or strong ultraviolet light for a long time.

8.0 MECHANICAL DIAGRAM

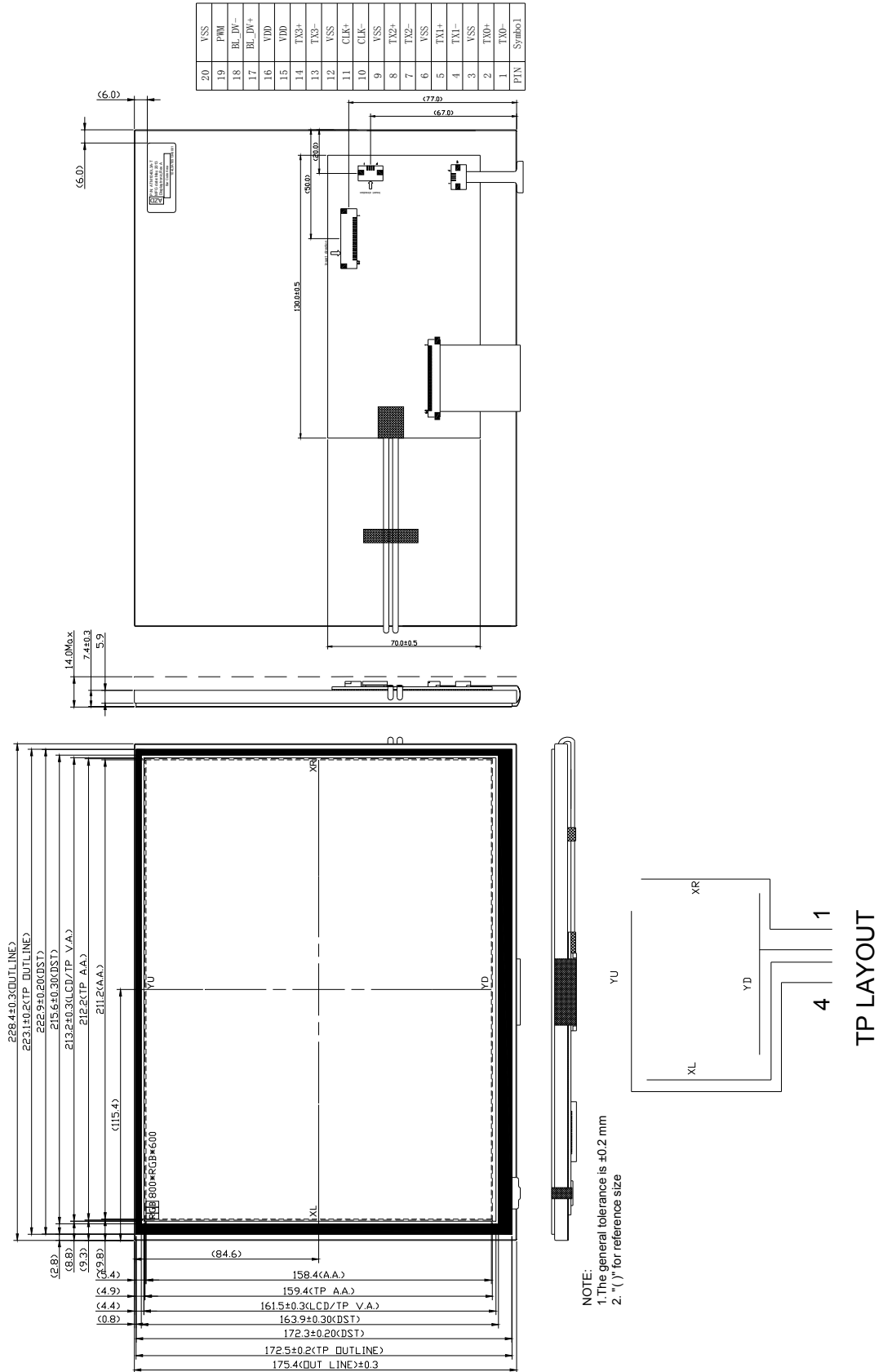

9.0 PACKAGE DRAWING

TBD.

10.0 INSPECTION SPECIFICATION

SCOPE SPECIFICATIONS CONTAIN

- 1.1 DISPLAY QUALITY EVALUATION
- 1.2 MECHANICS SPECIFICATION

SAMPLING PLAN

UNLESS THERE IS OTHER AGREEMENT, THE SAMPLING PLAN FOR INCOMING INSPECTION SHALL FOLLOW MIL-STD-105E.

- 2.1 LOT SIZE: QUANTITY PER SHIPMENT AS ONE LOT (DIFFERENT MODEL AS DIFFERENT LOT).
- 2.2 SAMPLING TYPE: NORMAL INSPECTION, SINGLE SAMPLING.
- 2.3 SAMPLING LEVEL: LEVEL II.
- 2.4 AQL: ACCEPTABLE QUALITY LEVEL
 MAJOR DEFECT: AQL=0.65
 MINOR DEFECT: AQL=1.0

PANEL INSPECTION CONDITION

- 3.1 ENVIRONMENT:
 ROOM TEMPERATURE: 25±5°C.
 HUMIDITY: 65±5% RH.
 ILLUMINATION: 300 ~ 700 LUX.
- 3.2 INSPECTION DISTANCE:
 35±5 CM
- 3.3 INSPECTION ANGLE:
 THE VISION OF INSPECTOR SHOULD BE PERPENDICULAR TO THE SURFACE OF THE MODULE.
- 3.4 INSPECTION TIME:
 PERCEPTIBILITY TEST TIME: 20 SECONDS MAX.

4. DISPLAY QUALITY



- 4.1 FUNCTION RELATED:
 THE FUNCTION DEFECTS OF LINE DEFECT, ABNORMAL DISPLAY, AND NO DISPLAY ARE CONSIDERED MAJOR DEFECTS.
- 4.2 BRIGHT/DARK DOTS:

Defect Type	Specification	Major	Minor
Bright Dots	$N \leq 3$		●
Dark Dots	$N \leq 4$		●
Total Bright and Dark Dots	$N \leq 6$		●

Note: 1:

- The definition of dot: The size of a defective dot over 1/2 of whole dot is regarded as one defective dot.
- Bright dot: Dots appear bright and unchanged in size in which LCD panel is displaying under black pattern.
- The bright dot defect must be visible through 2% ND filter
- Dark dot: Dots appear dark and unchanged in size in which LCD panel is displaying under pure red, green, blue pattern.

4.3 Pixel Definition:

R	G	B	R	G	B	R	G	B			Dot Defect
R	G	B	R	G	B	R	G	B			Adjacent Dot Defect
R	G	B	R	G	B	R	G	B			Cluster

Note 1:

If pixel or partial sub-pixel defects exceed 50% of the affected pixel or sub-pixel area, it shall be considered as 1 defect.

Note 2:

There should be no distinct non-uniformity visible through 2% ND Filter within 2 sec inspection times.

ATM1040L3A-T1(AZ DISPLAYS) TFT MODULE VER1.0

4.4 Visual Inspection specifications:

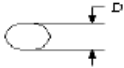
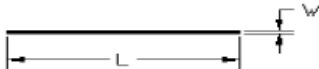
<u>Defect Type</u>		<u>Specification Size</u>	<u>Count(N)</u>	Major	Minor	
Dot Shape (Particle · Scratch and Bubbles in display area) 		$D \leq 0.3 \text{ mm}$	Ignored			
		$0.3\text{mm} < D \leq 0.5\text{mm}$	$N \leq 4$		•	
		$D > 0.5\text{mm}$	$N=0$			
Newton Ring (Only for Touch panel)		$D \leq 70\text{mm}$	$N \leq 4$		•	
		$D > 70\text{mm}$	$N=0$			
TSP Fish Eyes (Only for Touch panel) (Bubble/Dent)		$0.1\text{mm} < D \leq 0.2\text{mm}$	$N \leq 4$			
		$0.2\text{mm} < D \leq 0.3\text{mm}$	$N \leq 3$		•	
		$0.3 < D \leq 0.4$	$N \leq 2$			
Line Shape (Particles · Scratch · Lint and Bubbles in display area) 		$W \leq 0.07 \text{ mm}$	Ignored			
		$0.07\text{mm} < W \leq 0.1\text{mm}$ and $L \leq 5\text{mm}$	$N \leq 4$		•	
		$W > 0.10\text{mm}$ or $L > 5\text{mm}$	$N=0$			
Bubble in cell (active area)		It should be found by eyes			•	
Bezel	Scratch	No harm			•	
	Dirt				•	
	Wrap				•	
	Sunken				•	
Label	No label	No			•	
	Inverted label				•	
	Broken				•	
	Dirt			Word can be read.		•
	Not clear					•
	Word out of shape					•
	Mistake					•
	Position			Be attached on right position		•
Screw	Not enough	No			•	
	Limp	No			•	

ATM1040L3A-T1(AZ DISPLAYS) TFT MODULE VER1.0

Connector	Connection status	No bend on pins and damage		•
FPC/FFC	Broken	No		•

Note: Extraneous substance and scratch not affecting the display of image, for instance, extraneous substance under polarizer film but outside the display area, or scratch on metal bezel and backlight module or polarizer film outside the display area, shall not be considered as defective or non-conforming.