

## Evaluation Board for the 1.2 A, 20 V Nonsynchronous Step-Down Regulators

### FEATURES

- 1.2 A maximum load current**
- ±2% output accuracy over temperature range**
- Wide input voltage range: 3.0 V to 20 V**
- Output voltage from 0.8 V to  $0.85 \times V_{IN}$**
- 700 kHz (ADP2300) or 1.4 MHz (ADP2301) switching frequency options**
- Automatic PFM/PWM mode switching**
- Precision enable pin with hysteresis**
- Integrated high-side MOSFET**
- Integrated bootstrap diode**
- ADIsimPower™ online design tool**
- Available in ultrasmall, 6-lead TSOT package**

### GENERAL DESCRIPTION

The [ADP2300/ADP2301](#) are compact, constant-frequency, current-mode, step-down dc-to-dc regulators with an integrated power MOSFET. The ADP2300/ADP2301 evaluation boards are complete solutions that allow the user to evaluate the performance of the regulators. There are two frequency options available: the ADP2300 runs at 700 kHz, and the ADP2301 runs at 1.4 MHz. These options allow the user to make design decisions based on the trade-off between efficiency and the size of the total solution.

The ADP2300/ADP2301 provide accurate ( $\pm 2\%$ ) output regulation for load currents up to 1.2 A. Current-mode control provides fast and stable line and load transient performance. The precision, EN pin, threshold voltage allows the ADP2300/ADP2301 to be sequenced from other input/output supplies. The EN pin can also be used as a programmable UVLO input by using a resistive divider.

### DEMONSTRATION BOARD

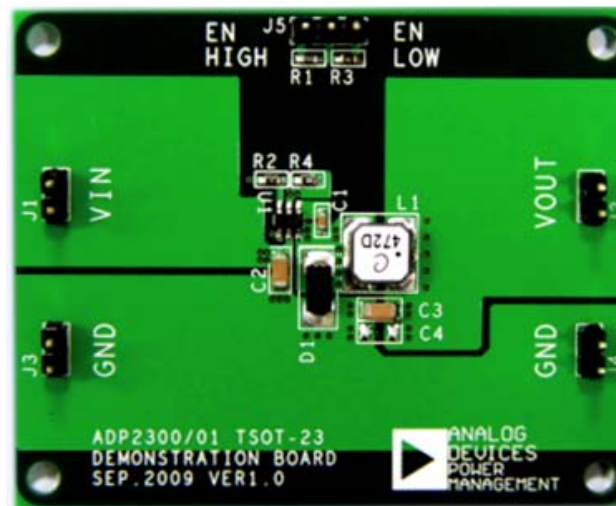

Figure 1.

**TABLE OF CONTENTS**

Features .....	1	Input and Output Voltmeter Connections.....	3
General Description .....	1	Power On the Evaluation Board.....	3
Demonstration Board .....	1	Measuring Evaluation Board Performance .....	3
Revision History .....	2	Typical Performance Characteristics .....	5
Using the Evaluation Board.....	3	Demonstration Board Schematics and Bill of Materials .....	7
Jumper Setting .....	3	ADP2300 Schematic and Bill of Materials .....	7
Input Power Source Connection .....	3	ADP2301 Schematic and Bill of Materials .....	8
Output Load Connection .....	3	Demonstration Board Layout .....	9

**REVISION HISTORY**

8/10—Revision 0: Initial Version

## USING THE EVALUATION BOARD

The ADP2300/ADP2301 evaluation boards are fully assembled and tested. Before applying power to the evaluation boards, follow the procedures in this section.

### JUMPER SETTING

Jumper J5 enables the part. Connect a jumper between Position 1 and Position 2 to enable the part. Connect a jumper between Position 2 and Position 3 to disable the part. Leave Jumper J5 open to obtain an approximately 7.8 V  $V_{IN}$  start-up voltage.

**Table 1. Jumper J5 (EN) Setting**

State	Function
High	Enable the part
Low	Disable the part
Open	Program the $V_{IN}$ start-up voltage to be about 7.8 V

### INPUT POWER SOURCE CONNECTION

Before connecting the power source to the ADP2300/ADP2301 evaluation board, make sure that the evaluation board is turned off. If the input power source includes a current meter, use that meter to monitor the input current. Connect the positive terminal of the power source to the  $V_{IN}$  terminal (J1) on the evaluation board, and the negative terminal of the power source to the GND terminal (J3) of the board. If the power source does not include a current meter, connect a current meter in series with the input source voltage. Connect the positive terminal of the power source to the current meter's positive lead (+), the negative terminal of the power source to the GND terminal (J3) on the evaluation board, and the negative lead (–) of the current meter to the  $V_{IN}$  terminal (J1) on the board.

### OUTPUT LOAD CONNECTION

Make sure that the board is turned off before connecting the load. If the load includes a current meter, or if the current is not measured, connect the load directly to the demonstration board with the positive (+) load connection to the  $V_{OUT}$  terminal (J2) and negative (–) load connection to the GND terminal (J4). If a current meter is used, connect it in series with the load; connect the positive (+) current meter terminal to the evaluation board  $V_{OUT}$  terminal (J2), the negative (–) current meter terminal to the positive (+) load terminal, and the negative (–) load terminal to the evaluation board GND terminal (J4).

### INPUT AND OUTPUT VOLTMETER CONNECTIONS

Measure the input and output voltages with voltmeters. Make sure that the voltmeters are connected to the appropriate test point on the board. If the voltmeters are not connected to the right test point, the measured voltages will be incorrect due to the voltage drop across the leads and/or connections between the board, the power source, and/or the load.

Connect the input voltage measuring the voltmeter's positive terminal (+) to the input capacitor (C2) positive terminal and the negative (–) terminal to the input capacitor (C2) negative terminal.

Connect the output voltage measuring the voltmeter's positive (+) terminal to the output capacitor (C3 or C4) positive terminal and the negative (–) terminal to the output capacitor (C3 or C4) negative terminal.

### POWER ON THE EVALUATION BOARD

When the power source and load are connected to the ADP2300/ADP2301 evaluation board, they can be powered up for operation. If the input power source voltage goes higher than 7.8 V with Jumper J5 open, the output voltage goes up to 3.3 V.

### MEASURING EVALUATION BOARD PERFORMANCE

#### Measuring the Switching Waveform

To observe the switching waveform with an oscilloscope, place the oscilloscope probe tip at the end of inductor connected to the SW pin with the probe ground at GND. Set the scope to dc, 5 V/division, and 1  $\mu$ s/division time base. The switching waveform should alternate between 0 V and approximately the input voltage.

#### Measuring Load Regulation

Load regulation should be tested by increasing the load current at the output and measuring the output voltage across the output capacitor (C3 or C4).

#### Measuring Line Regulation

Vary the input voltage and measure the output voltage at a fixed output current. The input voltage can be measured across the input capacitor (C2), and the output voltage can be measured across the output capacitor (C3 or C4).

#### Measuring Efficiency

The efficiency,  $\eta$ , is measured by comparing the input power with the output power.

$$\eta = \frac{V_{OUT} \times I_{OUT}}{V_{IN} \times I_{IN}}$$

#### Measuring Inductor Current

The inductor current is measured by removing one end of the inductor from the pad on the board and using a wire connected between the pad and the inductor. Then a current probe is used to measure the inductor current.

**Measuring Output Voltage Ripple**

To observe the output voltage ripple, place an oscilloscope probe across the output capacitor (C3 or C4) with the probe ground lead at the negative (–) capacitor terminal and the probe tip at the positive (+) capacitor terminal. Set the oscilloscope to ac, 1 mV/division, and 1 μs/division time base, 20 MHz bandwidth.

The standard oscilloscope probe has a long wire ground clip. For high frequency measurements, this ground clip picks up high frequency noise and injects it into the measured output ripple. Make sure to keep the ground lengths on the oscilloscope probe as short as possible to get a clean voltage ripple measurement.

**Varying the Output voltage**

The [ADP2300/ADP2301](#) demonstration board output is preset to 3.3 V; however, the output voltage can be adjusted to other output voltages using the following equation:

$$V_{OUT} = 0.800 \text{ V} \times \left( 1 + \frac{R_2}{R_4} \right)$$

# TYPICAL PERFORMANCE CHARACTERISTICS

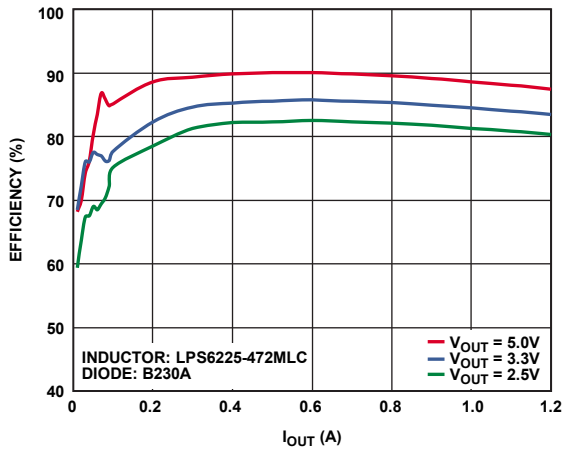

Figure 2. Efficiency Curve,  $V_{IN} = 12V$ ,  $f_{SW} = 1.4MHz$

09232-072

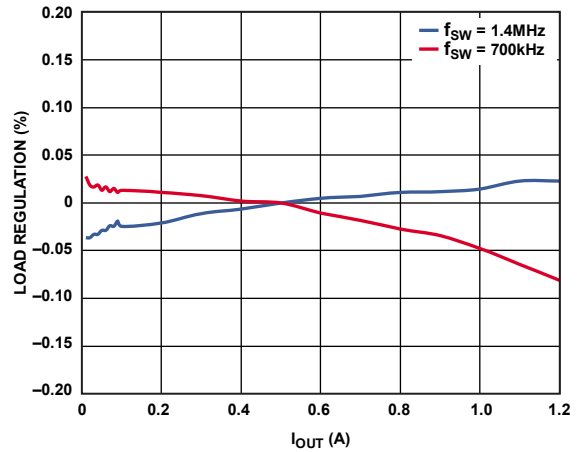

Figure 5. Load Regulation,  $V_{OUT} = 3.3V$ ,  $V_{IN} = 12V$

09232-067

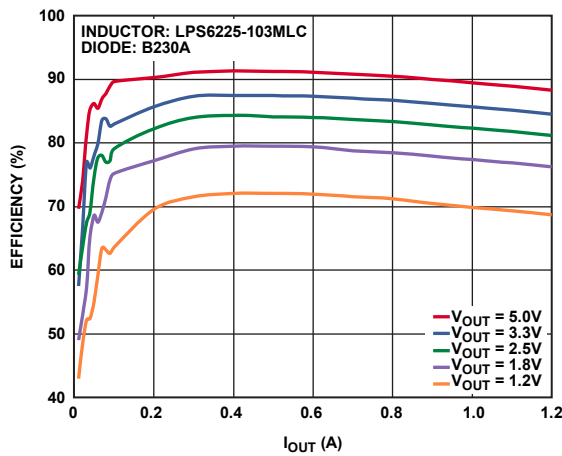

Figure 3. Efficiency Curve,  $V_{IN} = 12V$ ,  $f_{SW} = 700kHz$

09232-073

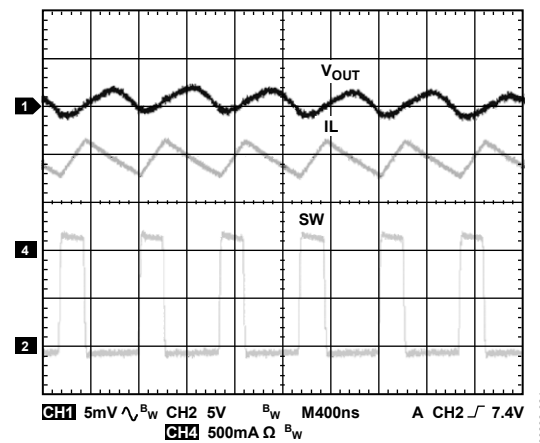

Figure 6. Steady State at Heavy Load,  $f_{SW} = 1.4MHz$ ,  $I_{OUT} = 1A$

09232-024

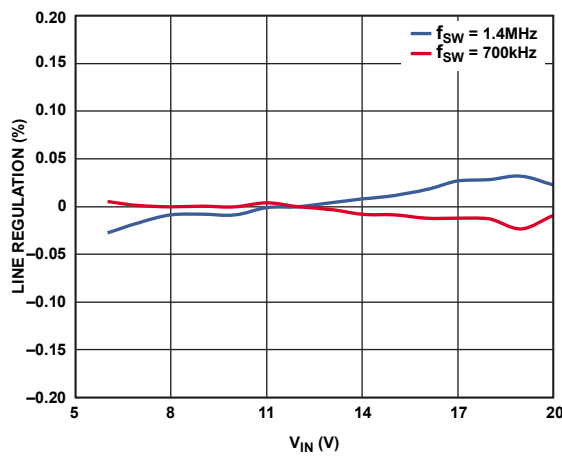

Figure 4. Line Regulation,  $V_{OUT} = 3.3V$ ,  $I_{OUT} = 500mA$

09232-068

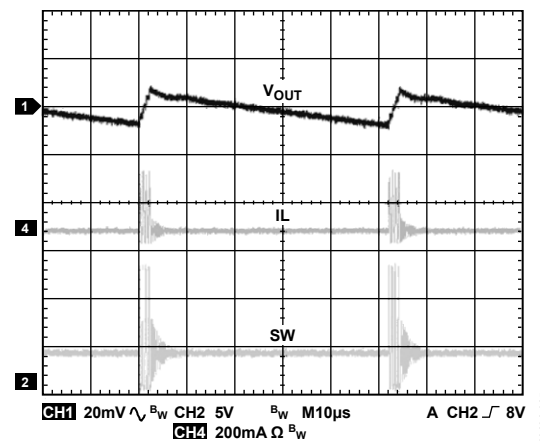

Figure 7. Steady State at Light Load,  $f_{SW} = 1.4MHz$ ,  $I_{OUT} = 40mA$

09232-025

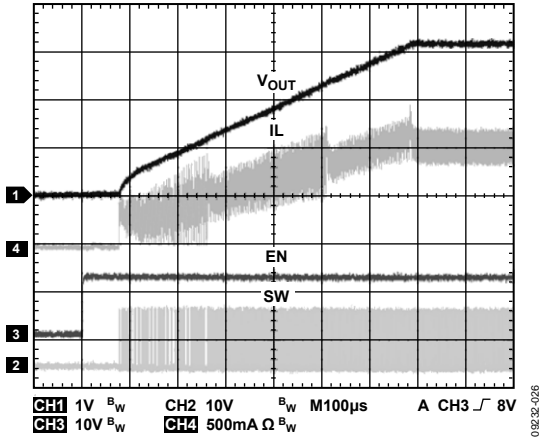

Figure 8. Soft Start with 1 A Resistance Load,  $f_{SW} = 1.4$  MHz

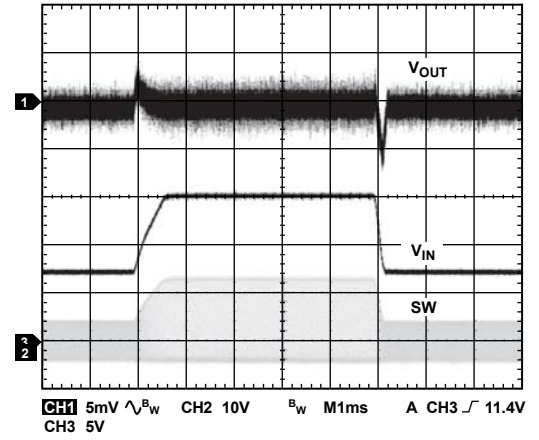

Figure 11. ADP2301 Line Transient, 7 V to 15 V,  $V_{OUT} = 3.3$  V,  $I_{OUT} = 1.2$  A,  $f_{SW} = 1.4$  MHz

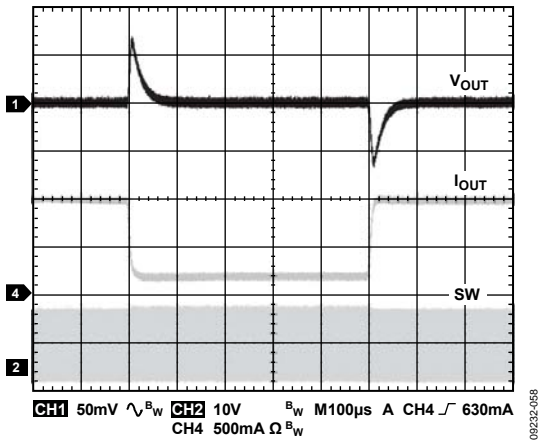

Figure 9. ADP2301 Load Transient, 0.2 A to 1.0 A,  $V_{OUT} = 3.3$  V,  $V_{IN} = 12$  V ( $f_{SW} = 1.4$  MHz,  $L = 4.7$   $\mu$ H,  $C_{OUT} = 22$   $\mu$ F)

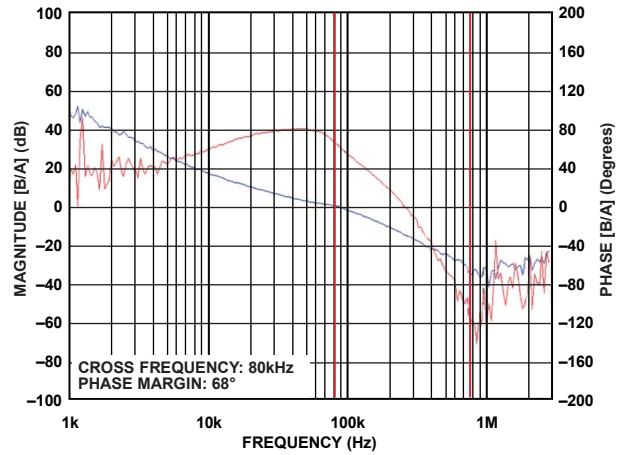

Figure 12. ADP2301 Bode Plot,  $V_{OUT} = 3.3$  V,  $V_{IN} = 12$  V ( $f_{SW} = 1.4$  MHz,  $L = 4.7$   $\mu$ H,  $C_{OUT} = 22$   $\mu$ F)

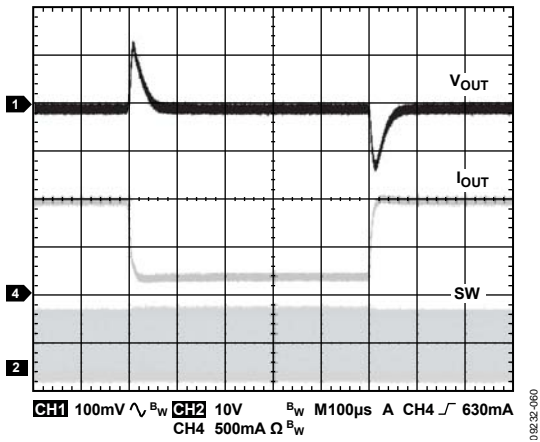

Figure 10. ADP2300 Load Transient, 0.2 A to 1.0 A,  $V_{OUT} = 3.3$  V,  $V_{IN} = 12$  V ( $f_{SW} = 700$  kHz,  $L = 10$   $\mu$ H,  $C_{OUT} = 22$   $\mu$ F)

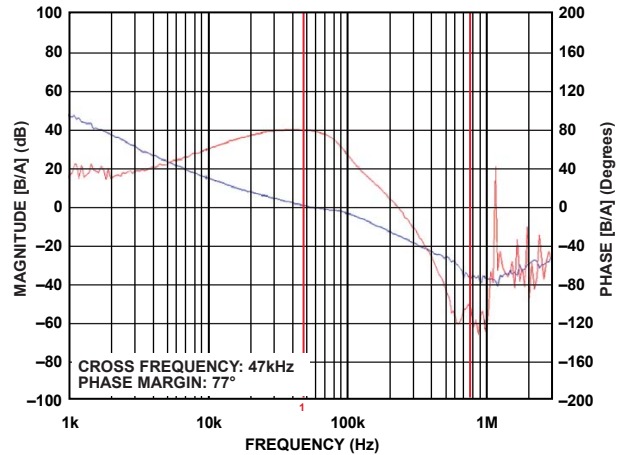

Figure 13. ADP2300 Bode Plot,  $V_{OUT} = 3.3$  V,  $V_{IN} = 12$  V ( $f_{SW} = 700$  kHz,  $L = 10$   $\mu$ H,  $C_{OUT} = 22$   $\mu$ F)

## DEMONSTRATION BOARD SCHEMATICS AND BILL OF MATERIALS

### ADP2300 SCHEMATIC AND BILL OF MATERIALS

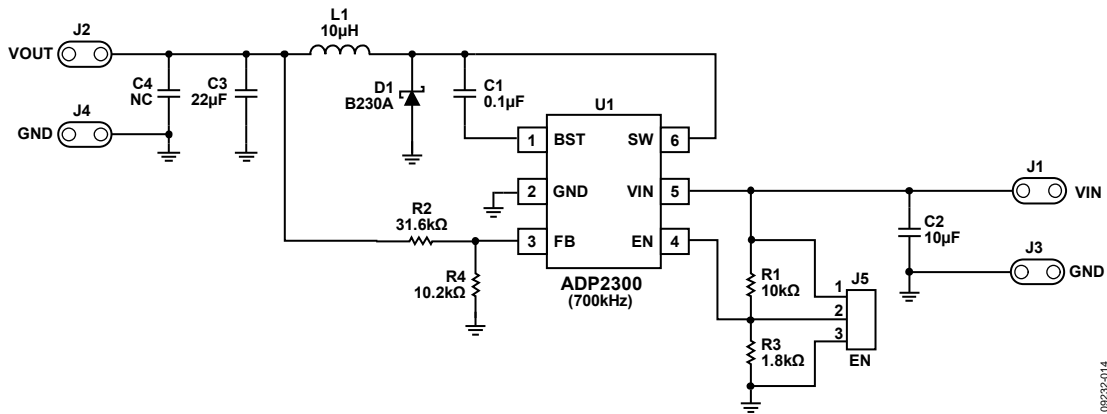

Figure 14. ADP2300 Demonstration Board Schematic

09232-014

Table 2. ADP2300 Demonstration Board Bill of Materials

Qty	Reference Designator	Description	Manufacturer	Part Number
1	C1	Capacitor, 0.1 µF, 25 V, 0603, X7R	Murata	GRM188R71E104KA01
1	C2	Capacitor, 10 µF, 25 V, 1206, X5R	Murata	GRM31CR61E106KA12
1	C3	Capacitor, 22 µF, 6.3 V, 1206, X5R	Murata	GRM31CR60J226KE19
1	C4	No assembly	N/A <sup>1</sup>	N/A <sup>1</sup>
1	D1	Schottky diode, 2 A, 30 V, SMA	Diodes, Inc.	B230A
4	J1, J2, J3, J4	Header, 1 × 2, 0.1 pitch	Harwin	M20-9990246
1	J5	Header, 1 × 3, 0.1 pitch	Harwin	M20-9990346
1	L1	Shielded power inductor, 10 µH, 2.1 A	Coilcraft, Inc.	LPS6225-103MLC
1	R1	Resistor, 10 kΩ, 1%, 0603	Vishay	CRCW060310K0FKEA
1	R2	Resistor, 31.6 kΩ, 1%, 0603	Vishay	CRCW060331K6FKEA
1	R3	Resistor, 1.8 kΩ, 1%, 0603	Vishay	CRCW06031K80FKEA
1	R4	Resistor, 10.2 kΩ, 1%, 0603	Vishay	CRCW060310K2FKEA
1	U1	1.2 A, 20 V, 700 kHz nonsynchronous step-down switching regulator	Analog Devices, Inc.	ADP2300

<sup>1</sup> N/A is not applicable.

ADP2301 SCHEMATIC AND BILL OF MATERIALS

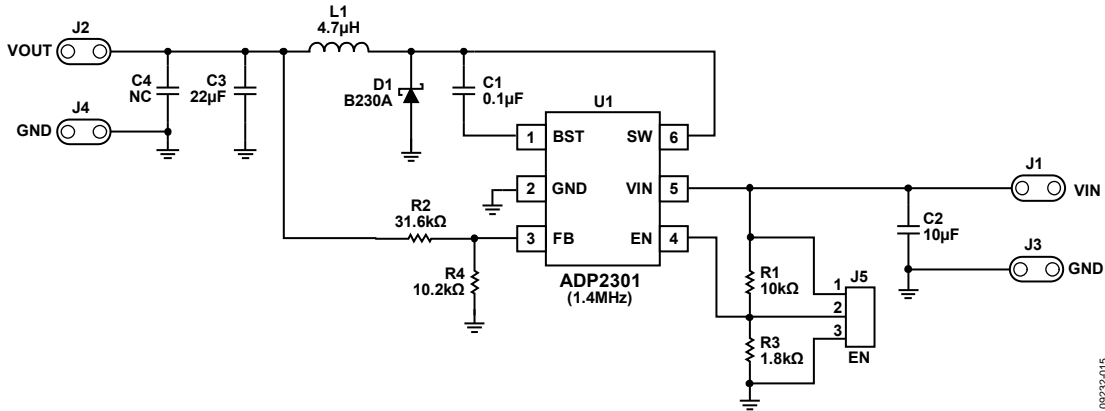

Figure 15. ADP2301 Demonstration Board Schematic

Table 3. ADP2301 Demonstration Board Bill of Materials

Qty	Reference Designator	Description	Manufacturer	Part Number
1	C1	Capacitor, 0.1 µF, 25 V, 0603, X7R	Murata	GRM188R71E104KA01
1	C2	Capacitor, 10 µF, 25 V, 1206, X5R	Murata	GRM31CR61E106KA12
1	C3	Capacitor, 22 µF, 6.3 V, 1206, X5R	Murata	GRM31CR60J226KE19
1	C4	No assembly	N/A <sup>1</sup>	N/A <sup>1</sup>
1	D1	Schottky diode, 2 A, 30 V, SMA	Diodes, Inc.	B230A
4	J1, J2, J3, J4	Header, 1 × 2, 0.1 pitch	Harwin	M20-9990246
1	J5	Header, 1 × 3, 0.1 pitch	Harwin	M20-9990346
1	L1	Shielded power inductor, 4.7 µH, 3.0 A	Coilcraft, Inc.	LPS6225-472MLC
1	R1	Resistor, 10 kΩ, 1%, 0603	Vishay	CRCW060310K0FKEA
1	R2	Resistor, 31.6 kΩ, 1%, 0603	Vishay	CRCW060331K6FKEA
1	R3	Resistor, 1.8 kΩ, 1%, 0603	Vishay	CRCW06031K80FKEA
1	R4	Resistor, 10.2 kΩ, 1%, 0603	Vishay	CRCW060310K2FKEA
1	U1	1.2 A, 20 V, 1.4 MHz nonsynchronous step-down switching regulator	Analog Devices, Inc.	ADP2301

<sup>1</sup> N/A is not applicable.



### DEMONSTRATION BOARD LAYOUT

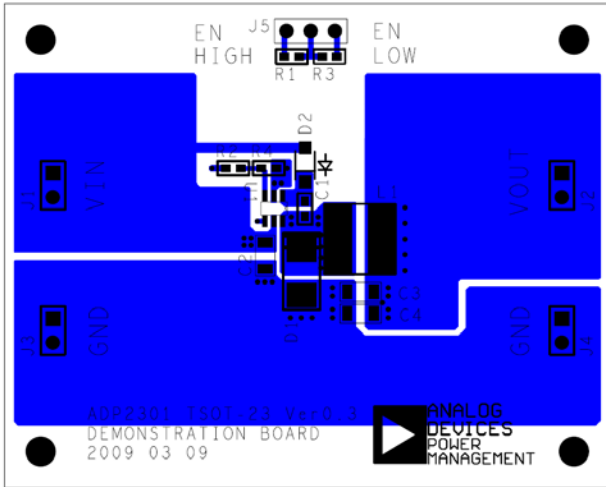

Figure 16. Demonstration Board, Top Layer

09232-016

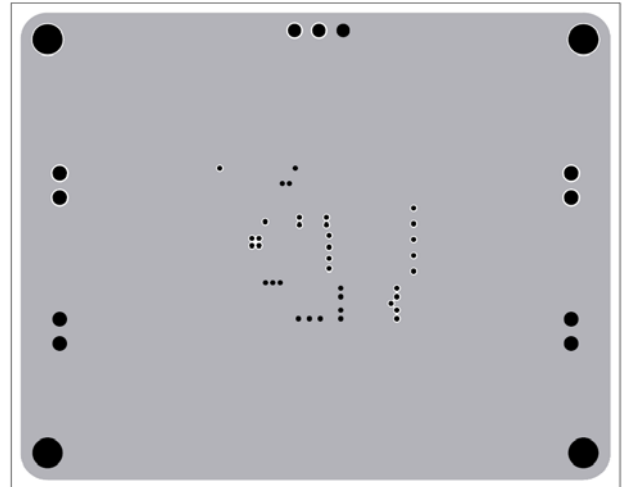

Figure 18. Demonstration Board, Second Layer

09232-018

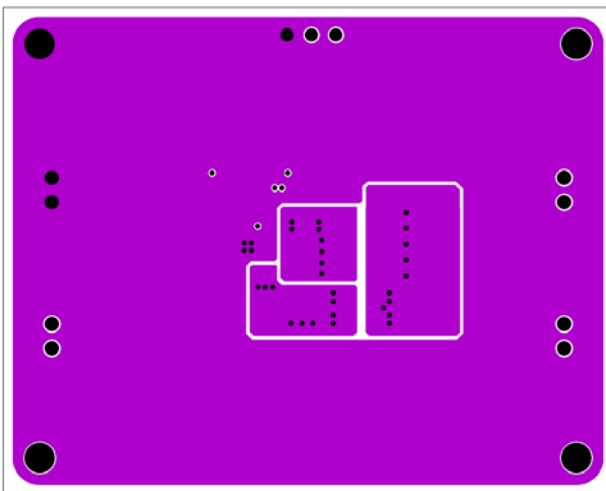

Figure 17. Demonstration Board, Third Layer

09232-017

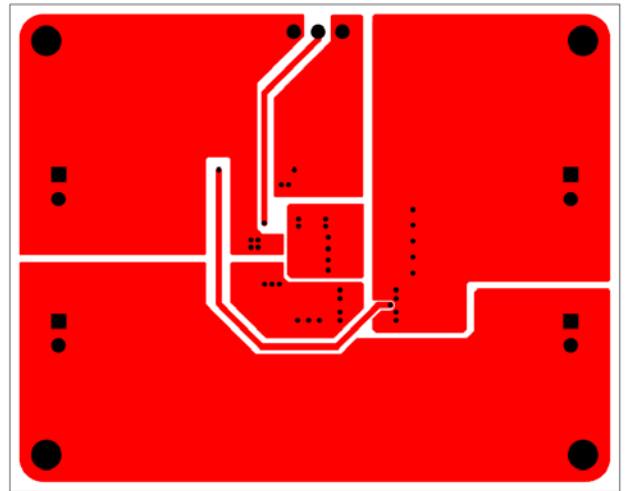

Figure 19. Demonstration Board, Bottom Layer

09232-019

**NOTES**

**NOTES**

## NOTES

**ESD Caution**

**ESD (electrostatic discharge) sensitive device.** Charged devices and circuit boards can discharge without detection. Although this product features patented or proprietary protection circuitry, damage may occur on devices subjected to high energy ESD. Therefore, proper ESD precautions should be taken to avoid performance degradation or loss of functionality.

**Legal Terms and Conditions**

By using the evaluation board discussed herein (together with any tools, components documentation or support materials, the "Evaluation Board"), you are agreeing to be bound by the terms and conditions set forth below ("Agreement") unless you have purchased the Evaluation Board, in which case the Analog Devices Standard Terms and Conditions of Sale shall govern. Do not use the Evaluation Board until you have read and agreed to the Agreement. Your use of the Evaluation Board shall signify your acceptance of the Agreement. This Agreement is made by and between you ("Customer") and Analog Devices, Inc. ("ADI"), with its principal place of business at One Technology Way, Norwood, MA 02062, USA. Subject to the terms and conditions of the Agreement, ADI hereby grants to Customer a free, limited, personal, temporary, non-exclusive, non-sublicensable, non-transferable license to use the Evaluation Board FOR EVALUATION PURPOSES ONLY. Customer understands and agrees that the Evaluation Board is provided for the sole and exclusive purpose referenced above, and agrees not to use the Evaluation Board for any other purpose. Furthermore, the license granted is expressly made subject to the following additional limitations: Customer shall not (i) rent, lease, display, sell, transfer, assign, sublicense, or distribute the Evaluation Board; and (ii) permit any Third Party to access the Evaluation Board. As used herein, the term "Third Party" includes any entity other than ADI, Customer, their employees, affiliates and in-house consultants. The Evaluation Board is NOT sold to Customer; all rights not expressly granted herein, including ownership of the Evaluation Board, are reserved by ADI. CONFIDENTIALITY. This Agreement and the Evaluation Board shall all be considered the confidential and proprietary information of ADI. Customer may not disclose or transfer any portion of the Evaluation Board to any other party for any reason. Upon discontinuation of use of the Evaluation Board or termination of this Agreement, Customer agrees to promptly return the Evaluation Board to ADI. ADDITIONAL RESTRICTIONS. Customer may not disassemble, decompile or reverse engineer chips on the Evaluation Board. Customer shall inform ADI of any occurred damages or any modifications or alterations it makes to the Evaluation Board, including but not limited to soldering or any other activity that affects the material content of the Evaluation Board. Modifications to the Evaluation Board must comply with applicable law, including but not limited to the RoHS Directive. TERMINATION. ADI may terminate this Agreement at any time upon giving written notice to Customer. Customer agrees to return to ADI the Evaluation Board at that time. LIMITATION OF LIABILITY. THE EVALUATION BOARD PROVIDED HEREUNDER IS PROVIDED "AS IS" AND ADI MAKES NO WARRANTIES OR REPRESENTATIONS OF ANY KIND WITH RESPECT TO IT. ADI SPECIFICALLY DISCLAIMS ANY REPRESENTATIONS, ENDORSEMENTS, GUARANTEES, OR WARRANTIES, EXPRESS OR IMPLIED, RELATED TO THE EVALUATION BOARD INCLUDING, BUT NOT LIMITED TO, THE IMPLIED WARRANTY OF MERCHANTABILITY, TITLE, FITNESS FOR A PARTICULAR PURPOSE OR NON-INFRINGEMENT OF INTELLECTUAL PROPERTY RIGHTS. IN NO EVENT WILL ADI AND ITS LICENSORS BE LIABLE FOR ANY INCIDENTAL, SPECIAL, INDIRECT, OR CONSEQUENTIAL DAMAGES RESULTING FROM CUSTOMER'S POSSESSION OR USE OF THE EVALUATION BOARD, INCLUDING BUT NOT LIMITED TO LOST PROFITS, DELAY COSTS, LABOR COSTS OR LOSS OF GOODWILL. ADI'S TOTAL LIABILITY FROM ANY AND ALL CAUSES SHALL BE LIMITED TO THE AMOUNT OF ONE HUNDRED US DOLLARS (\$100.00). EXPORT. Customer agrees that it will not directly or indirectly export the Evaluation Board to another country, and that it will comply with all applicable United States federal laws and regulations relating to exports. GOVERNING LAW. This Agreement shall be governed by and construed in accordance with the substantive laws of the Commonwealth of Massachusetts (excluding conflict of law rules). Any legal action regarding this Agreement will be heard in the state or federal courts having jurisdiction in Suffolk County, Massachusetts, and Customer hereby submits to the personal jurisdiction and venue of such courts. The United Nations Convention on Contracts for the International Sale of Goods shall not apply to this Agreement and is expressly disclaimed.