



DL100-21HA2112

Dx100

LONG RANGE DISTANCE SENSORS

SICK
Sensor Intelligence.



Illustration may differ



Ordering information

| Type | Part no. |
|----------------|----------|
| DL100-21HA2112 | 1058165 |

Other models and accessories → www.sick.com/Dx100

Detailed technical data

Performance

| | |
|--|--|
| Measuring range | 0.15 m ... 100 m, on reflective tape "Diamond Grade" |
| Resolution | 0.1 mm, 0.125 mm, 1 mm, 10 mm, 100 mm |
| Repeatability | 0.5 mm ¹⁾ |
| Accuracy | ± 2 mm ²⁾ |
| Dead time | 2 ms |
| Output time | Synchronous to PLC request (dependent on interfaces) |
| Light source | Laser, red ³⁾ |
| Laser class | 2 (EN 60825-1 / CDRH) |
| Typ. light spot size (distance) | 5 mm (+ 2 mm x distance in m) |
| Max. movement speed | 30 m/s |
| Acceleration (max.) | ≤ 15 m/s ² |
| Internal measurement cycle | 1 ms |
| Heating | ✓ |

¹⁾ Statistical error 1 σ , environmental conditions constant, min. warm-up time 10 min.

²⁾ From 150 mm ... 180 mm measuring range the accuracy can reach ± 4 mm.

³⁾ Average service life: 100,000 h at T_U = +25 °C.

Interfaces

| | |
|-----------------------------------|---------------------------------------|
| Switching output | B (push/pull), MF1, MF2 ¹⁾ |
| Multifunctional input (MF) | 1 x MF1 ²⁾ |
| Data interface | PROFINET |

¹⁾ HIGH > V_S - 3 V / LOW < 2 V.

²⁾ HIGH > 12 V / LOW < 3 V.

Mechanics/electronics

| | |
|--|---|
| Supply voltage V_s | DC 18 V ... 30 V, limit values |
| Ripple | 5 V _{pp} ¹⁾ |
| Initialization time | Typ. 1.5 s ²⁾ |
| Housing material | Aluminum/zinc die-cast |
| Connection type | Male connector, M12, SPEEDCON™ compatible |
| Indication | 6 digit 5 x 7 dot matrix display, LEDs |
| Weight | Approx. 800 g ... 1,600 g ³⁾ |
| Output current I_A | ≤ 100 mA ⁴⁾ |
| Current consumption | At 24 V DC < 1,000 mA |
| Modulation frequency | Fix |

¹⁾ May not fall short of or exceed V_s tolerances.

²⁾ After loss of reflector < 40 ms.

³⁾ Without mounting bracket: approx. 800 g, with mounting bracket: approx. 1,600 g.

⁴⁾ Short-circuit protected, overload-protected. Max. 100 nF / 20 mH.

Ambient data

| | |
|--|---|
| Enclosure rating | IP 65 |
| Protection class | III |
| Electromagnetic compatibility (EMC) | EN 61000-6-2, EN 61000-6-4 ¹⁾ |
| Ambient temperature | Operation with heating: -40 °C ... +55 °C Operation with cooling case: -40 °C ... +75 °C Storage: -40 °C ... +75 °C |
| Effect of air pressure | 0.3 ppm/hPa |
| Effect of air temperature | 1 ppm/K |
| Temperature drift | Typ. 0.1 mm/K |
| Mechanical load | Shock: (EN 600 68-2-27) Sine: (EN 600 68-2-6) Noise: (EN 600 68-2-64) |

¹⁾ This is a Class A device. This device can cause radio interference in living quarters.

Dimensional drawing (Dimensions in mm (inch))

Dimensional drawing

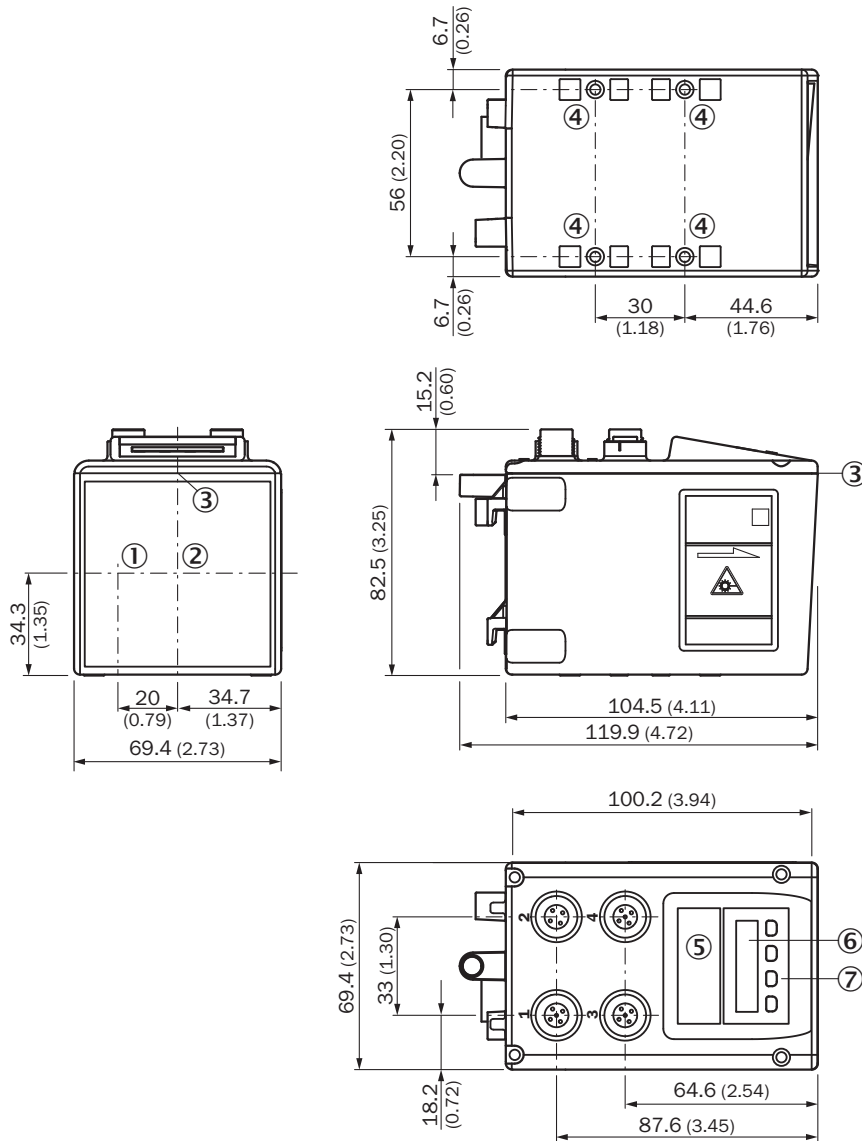

- ① Optical axis, sender
- ② Optical axis, receiver
- ③ Zero level
- ④ Threaded mounting hole M5
- ⑤ Status LED [status]
- ⑥ Display
- ⑦ Operating elements

Connection type

Dx100 Ethernet female connector, M12, 4-pin, D-coded

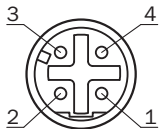

Dx100 PROFIBUS/PROFINET/CANopen/Ethernet/IP, M12 male connector, 4-pin, A-coded

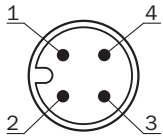

Dx100 PROFINET, port 1/port 2, M12 female connector, 4-pin, D-coded

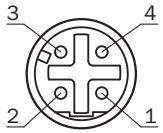

Connection diagram

Dx100 PROFIBUS/PROFINET, M12 male connector, 4-pin

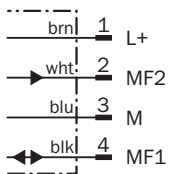

Ethernet M12 female connector, 4-pin

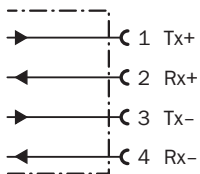

Adjustment possible



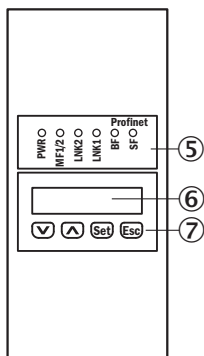

DL100-xxXXxx12



- ⑤ Status LED [status]
- ⑥ Display
- ⑦ Operating elements

Recommended accessories

Other models and accessories → www.sick.com/Dx100

| | Brief description | Type | Part no. |
|---|---|------------------|----------|
| Terminal and alignment brackets | | | |
|  | Alignment unit for Dx100, incl. mounting material, steel, zinc coated | BEF-AH-DX100 | 2058653 |
| Plug connectors and cables | | | |
|  | Head A: female connector, M12, 4-pin, straight Head B: cable Cable: PVC, unshielded, 5 m | DOL-1204-G05M | 6009866 |
|  | Head A: male connector, M12, 4-pin, straight, D-coded Head B: cable Cable: PROFINET, PVC, shielded, 5 m | STL-1204-G05MZ90 | 6048248 |
| Reflectors | | | |
|  | Reflector plate, reflective tape "Diamond Grade", 665 mm x 665 mm, material base plate: aluminum, screw connection, Screw-on, 4 hole mounting | PL560DG | 1016806 |

SICK AT A GLANCE

SICK is one of the leading manufacturers of intelligent sensors and sensor solutions for industrial applications. A unique range of products and services creates the perfect basis for controlling processes securely and efficiently, protecting individuals from accidents and preventing damage to the environment.

We have extensive experience in a wide range of industries and understand their processes and requirements. With intelligent sensors, we can deliver exactly what our customers need. In application centers in Europe, Asia and North America, system solutions are tested and optimized in accordance with customer specifications. All this makes us a reliable supplier and development partner.

Comprehensive services complete our offering: SICK LifeTime Services provide support throughout the machine life cycle and ensure safety and productivity.

For us, that is “Sensor Intelligence.”

WORLDWIDE PRESENCE:

Contacts and other locations –www.sick.com