

# NS6A12AT3G

## 600 Watt Peak Power Zener Transient Voltage Suppressor

### Unidirectional

The NS6A12AT3G is designed to protect voltage sensitive components from high voltage, high energy transients. This device has excellent clamping capability, high surge capability, low zener impedance and fast response time. The NS6A12AT3G is ideally suited for use in computer hard disk drives, communication systems, automotive, numerical controls, process controls, medical equipment, business machines, power supplies, and many other industrial/consumer applications.

#### Specification Features:

- Peak Reverse Working Voltage of 12 V
- Peak Pulse Power of 600 W (10 x 1000 µsec)
- ESD Rating of Class 3 (>16 kV) per Human Body Model
- ESD Rating of Class 4 (>8 kV) IEC 61000-4-2
- Fast Response Time
- Low Profile Package
- This is a Pb-Free Device

#### Mechanical Characteristics:

**CASE:** Void-free, transfer-molded, thermosetting plastic

**FINISH:** All external surfaces are corrosion resistant and leads are readily Solderable

**MAXIMUM CASE TEMPERATURE FOR SOLDERING PURPOSES:**  
260°C for 10 Seconds

**LEADS:** Modified L-Bend providing more contact area to bond pads

**POLARITY:** Cathode indicated by polarity band

**MOUNTING POSITION:** Any



Expertise Applied | Answers Delivered

Littelfuse.com

### PLASTIC SURFACE MOUNT ZENER OVERVOLTAGE TRANSIENT SUPPRESSOR

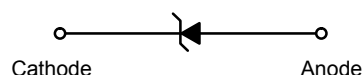

SMA  
CASE 403D  
PLASTIC

#### MARKING DIAGRAM



- 6LF = Specific Device Code
- A = Assembly Location
- Y = Year
- WW = Work Week
- = Pb-Free Package

#### ORDERING INFORMATION

| Device     | Package          | Shipping         |
|------------|------------------|------------------|
| NS6A12AT3G | SMA<br>(Pb-Free) | 5000/Tape & Reel |

# NS6A12AT3G

## MAXIMUM RATINGS

| Rating   | Symbol          | Value       | Unit  |
|--|-----------------|-------------|---|
| Peak Power Dissipation (Note 1) @ $T_L = 25^\circ\text{C}$ , Pulse Width = 1 ms  | $P_{PK}$        | 600         | W   |
| DC Power Dissipation @ $T_L = 75^\circ\text{C}$<br>Measured Zero Lead Length (Note 2)<br>Derate Above $75^\circ\text{C}$ | $P_D$           | 1.5         | W   |
| Thermal Resistance from Junction to Lead   | $R_{\theta JL}$ | 20<br>50    | mW/ $^\circ\text{C}$<br>$^\circ\text{C}/\text{W}$ |
| DC Power Dissipation (Note 3) @ $T_A = 25^\circ\text{C}$<br>Derate Above $25^\circ\text{C}$                              | $P_D$           | 0.5         | W   |
| Thermal Resistance from Junction to Ambient  | $R_{\theta JA}$ | 4.0<br>250  | mW/ $^\circ\text{C}$<br>$^\circ\text{C}/\text{W}$ |
| Operating and Storage Temperature Range  | $T_J, T_{stg}$  | -65 to +150 | $^\circ\text{C}$                                  |

Stresses exceeding those listed in the Maximum Ratings table may damage the device. If any of these limits are exceeded, device functionality should not be assumed, damage may occur and reliability may be affected.

- 10 X 1000  $\mu\text{s}$ , non-repetitive.
- 1" square copper pad, FR-4 board
- FR-4 board, using Littelfuse minimum recommended footprint, as shown in 403D case outline dimensions spec.

## ELECTRICAL CHARACTERISTICS ( $T_A = 25^\circ\text{C}$ unless otherwise noted)

| Symbol    | Parameter                                   |
|-----------|---|
| $I_{PP}$  | Maximum Reverse Peak Pulse Current          |
| $V_C$     | Clamping Voltage @ $I_{PP}$                 |
| $V_{RWM}$ | Working Peak Reverse Voltage                |
| $I_R$     | Maximum Reverse Leakage Current @ $V_{RWM}$ |
| $V_{BR}$  | Breakdown Voltage @ $I_T$                   |
| $I_T$     | Test Current                                |
| $I_F$     | Forward Current                             |
| $V_F$     | Forward Voltage @ $I_F$                     |

- 1/2 sine wave (or equivalent square wave), PW = 8.3 ms, non-repetitive duty cycle.

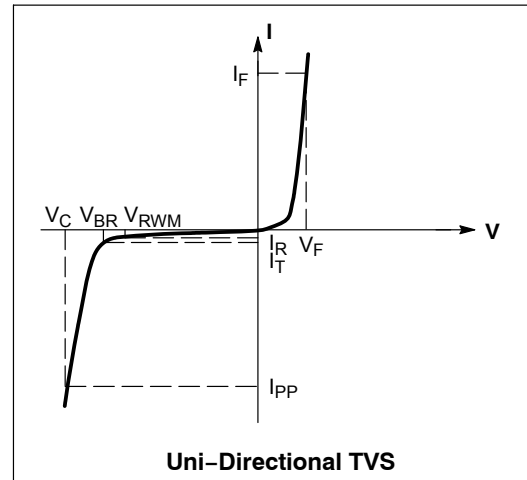

## ELECTRICAL CHARACTERISTICS

| Device     | Device Marking | $V_{RWM}$<br>(Note 5)<br>V | $I_R @ V_{RWM}$<br>$\mu\text{A}$ | Breakdown Voltage       |      |      | $V_C @ I_{PP}$ (Note 7) |       |          |
|------------|----------------|----------------------------|----------------------------------|-------------------------|------|------|-------------------------|-------|----------|
|            |                |                            |                                  | $V_{BR}$ (Note 6) Volts |      |      | @ $I_T$                 | $V_C$ | $I_{PP}$ |
|            |                |                            |                                  | Min                     | Nom  | Max  | mA                      | V     | A        |
| NS6A12AT3G | 6LF            | 12                         | 0.5                              | 13.3                    | 14.0 | 14.7 | 1.0                     | 31    | 19.5     |

- A transient suppressor is normally selected according to the working peak reverse voltage ( $V_{RWM}$ ), which should be equal to or greater than the DC or continuous peak operating voltage level.
- $V_{BR}$  measured at pulse test current  $I_T$  at an ambient temperature of  $25^\circ\text{C}$ .
- Surge current waveform per Figure 1.

# NS6A12AT3G

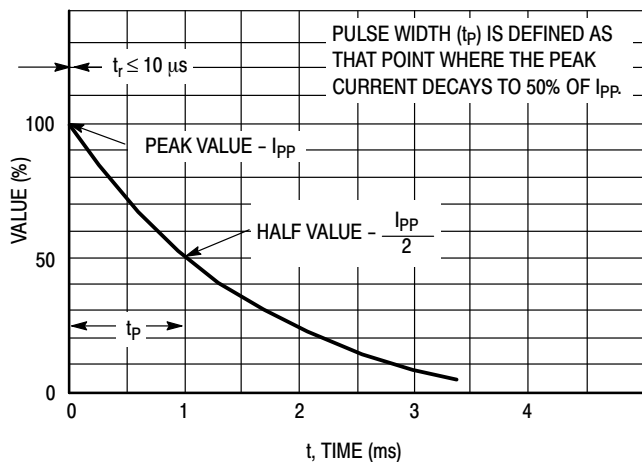

Figure 1.  $10 \times 1000 \mu\text{s}$  Pulse Waveform

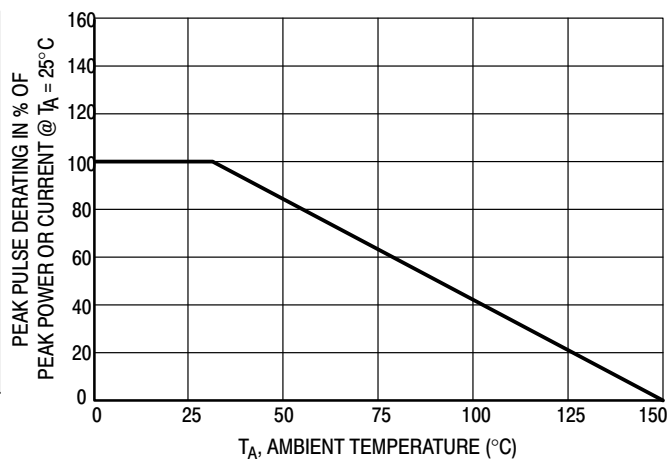

Figure 2. Pulse Derating Curve

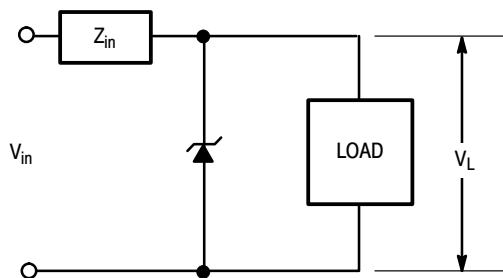
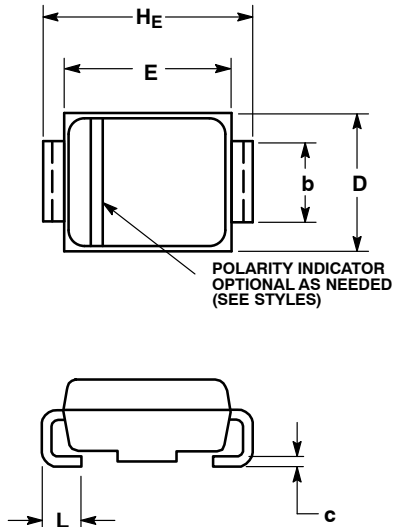

Figure 3. Typical Protection Circuit

# NS6A12AT3G

## PACKAGE DIMENSIONS

SMA  
CASE 403D-02  
ISSUE G



- NOTES:
1. DIMENSIONING AND TOLERANCING PER ANSI Y14.5M, 1982.
  2. CONTROLLING DIMENSION: INCH.
  3. DIMENSION b SHALL BE MEASURED WITHIN DIMENSION L.

| DIM | MILLIMETERS |      |      | INCHES |       |       |
|-----|-------------|------|------|--------|-------|-------|
|     | MIN         | NOM  | MAX  | MIN    | NOM   | MAX   |
| A   | 1.97        | 2.10 | 2.20 | 0.078  | 0.083 | 0.087 |
| A1  | 0.05        | 0.10 | 0.20 | 0.002  | 0.004 | 0.008 |
| b   | 1.27        | 1.45 | 1.63 | 0.050  | 0.057 | 0.064 |
| c   | 0.15        | 0.28 | 0.41 | 0.006  | 0.011 | 0.016 |
| D   | 2.29        | 2.60 | 2.92 | 0.090  | 0.103 | 0.115 |
| E   | 4.06        | 4.32 | 4.57 | 0.160  | 0.170 | 0.180 |
| HE  | 4.83        | 5.21 | 5.59 | 0.190  | 0.205 | 0.220 |
| L   | 0.76        | 1.14 | 1.52 | 0.030  | 0.045 | 0.060 |

### SOLDERING FOOTPRINT

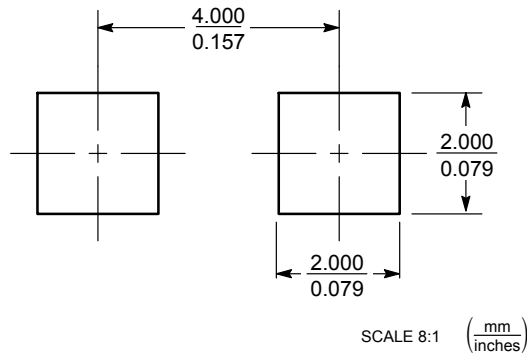

Littelfuse products are not designed for, and shall not be used for, any purpose (including, without limitation, automotive, military, aerospace, medical, life-saving, life-sustaining or nuclear facility applications, devices intended for surgical implant into the body, or any other application in which the failure or lack of desired operation of the product may result in personal injury, death, or property damage) other than those expressly set forth in applicable Littelfuse product documentation. Warranties granted by Littelfuse shall be deemed void for products used for any purpose not expressly set forth in applicable Littelfuse documentation. Littelfuse shall not be liable for any claims or damages arising out of products used in applications not expressly intended by Littelfuse as set forth in applicable Littelfuse documentation. The sale and use of Littelfuse products is subject to Littelfuse Terms and Conditions of Sale, unless otherwise agreed by Littelfuse.

Littelfuse.com