

LN4812LT1G

S-LN4812LT1G

30V N-Channel Enhancement-Mode MOSFET

1. FEATURES

- $V_{DS} = 30V$
- $R_{DS(ON)}, V_{GS}@4.5V, I_{DS}@5A = 52m\Omega$
- $R_{DS(ON)}, V_{GS}@10V, I_{DS}@6A = 38m\Omega$
- We declare that the material of product compliance with RoHS requirements and Halogen Free.
- S- prefix for automotive and other applications requiring unique site and control change requirements; AEC-Q101 qualified and PPAP capable.

2. APPLICATIONS

- High density cell design for ultra low on-resistance
- Advanced trench process technology
- High power and current handling capability

3. DEVICE MARKING AND ORDERING INFORMATION

Device	Marking	Shipping
LN4812LT1G	N48	3000/Tape&Reel
LN4812LT3G	N48	10000/Tape&Reel

4. MAXIMUM RATINGS($T_a = 25^\circ C$)

Parameter	Symbol	Limits	Unit
Drain-Source Voltage	V_{DSS}	30	V
Gate-to-Source Voltage – Continuous	V_{GS}	± 20	V
Drain Current			A
– Continuous $T_A = 25^\circ C$	I_D	6	
– Pulsed(Note 1)	I_{DM}	30	

5. THERMAL CHARACTERISTICS

Parameter	Symbol	Limits	Unit
Maximum Power Dissipation	PD	1.4	W
Thermal Resistance, Junction-to-Ambient(Note 2)	$R_{\theta JA}$	90	$^\circ C/W$
Junction and Storage temperature	T_J, T_{stg}	$-55 \sim +150$	$^\circ C$

1. Repetitive Rating: Pulse width limited by the Maximum junction temperature.
2. 1-in² 2oz Cu PCB board.

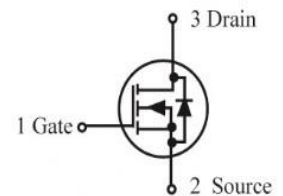
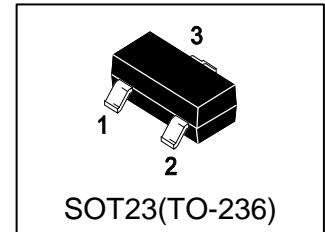

6. ELECTRICAL CHARACTERISTICS (Ta= 25°C)
OFF CHARACTERISTICS

Characteristic	Symbol	Min.	Typ.	Max.	Unit
Drain–Source Breakdown Voltage (VGS = 0, ID = 250 μ Adc)	V(BR)DSS	30	-	-	Vdc
Zero Gate Voltage Drain Current (VDS=24V, VGS=0V)	IDSS	-	-	1	μ Adc
Gate–Body Leakage Current, Forward (VDS = 0 V, VGS = 20 V)	IGSSF	-	-	100	nAdc
Gate–Body Leakage Current, Reverse (VDS = 0 V, VGS = -20 V)	IGSSR	-	-	-100	nAdc
Forward Transconductance (VDS=5V, ID=6.9A)	gfs	-	15.4	-	S

ON CHARACTERISTICS (Note 3)

Gate Threshold Voltage (VDS = VGS, ID = 250 μ Adc)	VGS(th)	1.0	1.5	3.0	Vdc
Static Drain–Source On–State Resistance (VGS = 10 V, ID = 6 A) (VGS = 4.5 V, ID = 5 A)	RDS(on)	- -	22 35	38 55	m Ω

DYNAMIC CHARACTERISTICS

Input Capacitance (VGS = 0 V, f = 1.0MHz, VDS= 15 V)	Ciss	-	610	-	pF
Output Capacitance (VGS = 0 V, f = 1.0MHz, VDS= 15 V)	Coss	-	100	-	pF
Reverse Transfer Capacitance (VGS = 0 V, f = 1.0MHz, VDS= 15 V)	Crss	-	77	-	pF

SWITCHING CHARACTERISTICS

Turn-On Delay Time	(VDD = 15V, RL =15 Ω , ID = 1A, VGEN = 10V RG = 6 Ω)	td(on)	-	9	-	ns
Rise Time		tr	-	14	-	
Turn-Off Delay Time		td(off)	-	30	-	
Fall Time		tf	-	5	-	

SOURCE–DRAIN DIODE CHARACTERISTICS

Forward Voltage (VGS = 0 Vdc, ISD = 1 Adc)	VSD	-	-	1.3	V
Max.Diode Forward Current	IS	-	-	3	A

3.Pulse Test: Pulse Width \leq 300 μ s, Duty Cycle \leq 2.0%.

7. ELECTRICAL CHARACTERISTICS CURVES

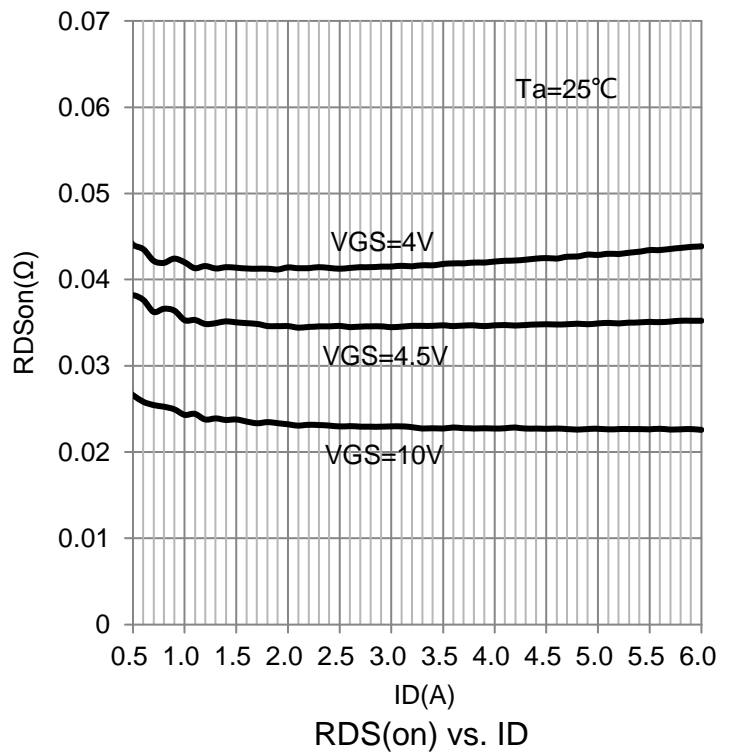
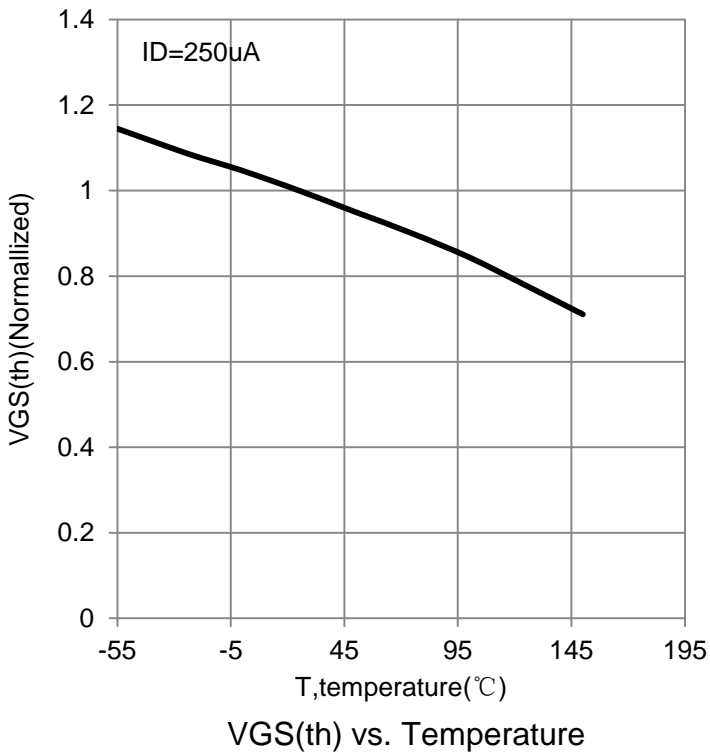
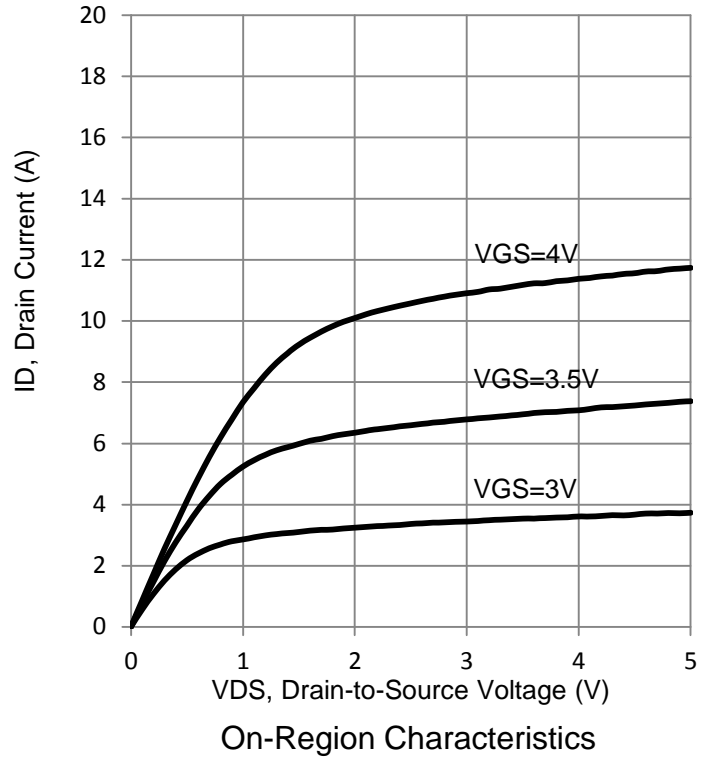
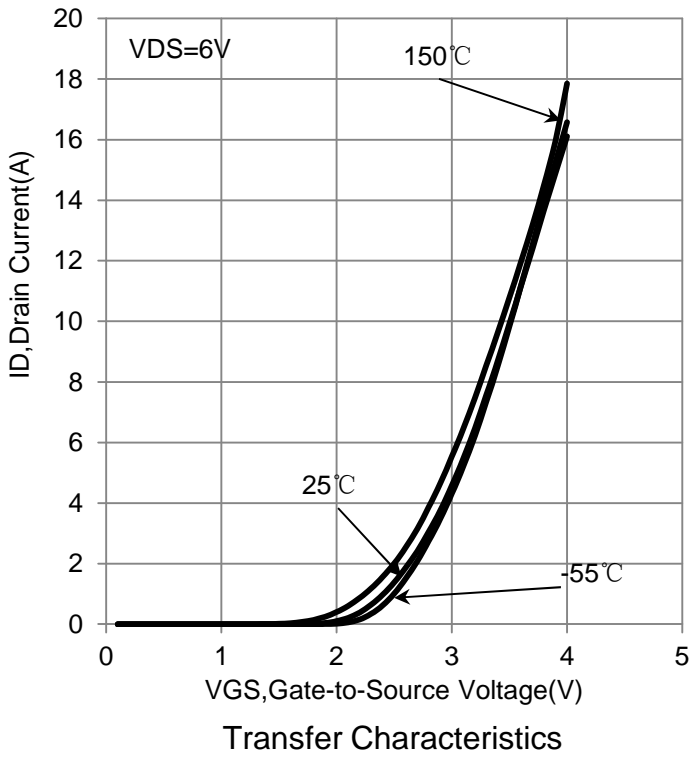

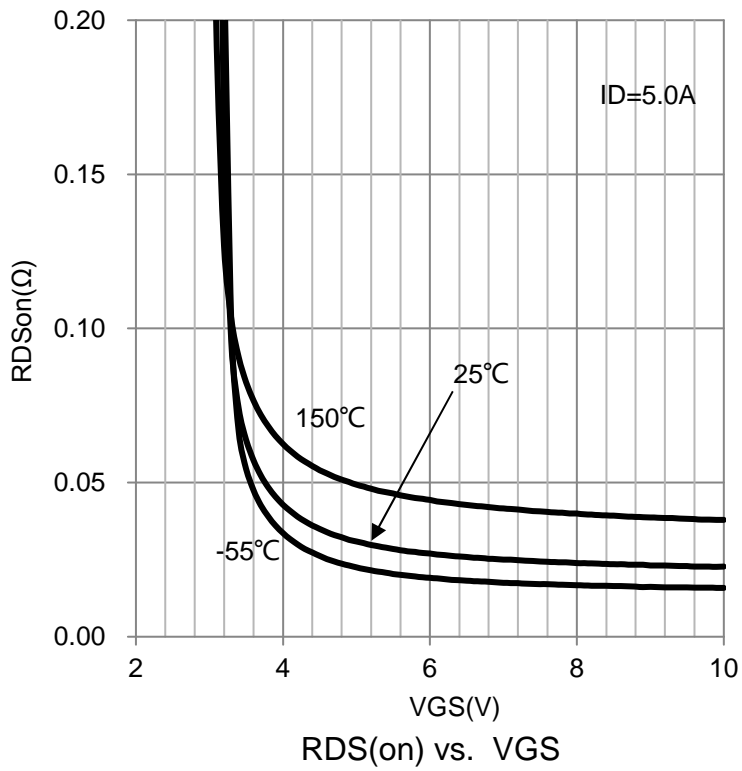
7. ELECTRICAL CHARACTERISTICS CURVES (Con.)

8. OUTLINE AND DIMENSIONS

Notes:

1. DIMENSIONING AND TOLERANCING PER ANSI Y14.5M, 1982.
2. CONTROLLING DIMENSION: MILLIMETERS.
3. MAXIMUM LEAD THICKNESS INCLUDES LEAD FINISH. MINIMUM LEAD THICKNESS IS THE MINIMUM THICKNESS OF BASE MATERIAL.
4. DIMENSIONS D AND E DO NOT INCLUDE MOLD FLASH, PROTRUSIONS OR GATE BURRS.

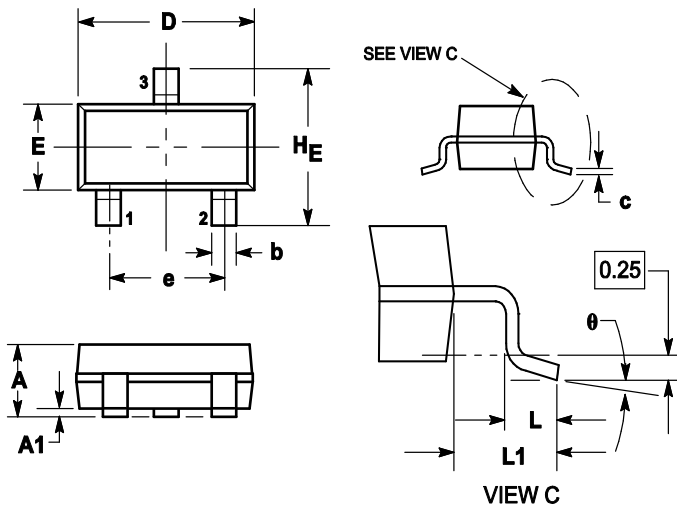

DIM	MILLIMETERS			INCHES		
	MIN	NOM	MAX	MIN	NOM	MAX
A	0.89	1	1.11	0.035	0.04	0.044
A1	0.01	0.06	0.1	0.001	0.002	0.004
b	0.37	0.44	0.5	0.015	0.018	0.02
c	0.09	0.13	0.18	0.003	0.005	0.007
D	2.80	2.9	3.04	0.11	0.114	0.12
E	1.20	1.3	1.4	0.047	0.051	0.055
e	1.78	1.9	2.04	0.07	0.075	0.081
L	0.10	0.2	0.3	0.004	0.008	0.012
L1	0.35	0.54	0.69	0.014	0.021	0.029
HE	2.10	2.4	2.64	0.083	0.094	0.104
theta	0°	---	10°	0°	---	10°

9. SOLDERING FOOTPRINT

