



1 dB Fixed Attenuator, QN Male to QN Female Rated to 1 Watt Up to 3 GHz

RF Fixed Attenuators Technical Data Sheet

PE7AP1000-1

Features

- Bidirectional
- DC to 3 GHz Frequency Range
- Attenuation 1 ± 0.5 dB
- Max Power 2 Watts (CW)
- VSWR < 1.3:1

Applications

- Instrumentation
- Precision measurements
- Prototyping and characterization
- Production systems

Description

Pasternack carries a wide range of fixed attenuators with a broad selection of attenuation levels, frequency ranges, and power dissipation ranges. RF microwave attenuators (also known as RF pads) lower the amplitude of a signal (attenuate) a known amount and can be used in a wide variety of applications. These attenuator pads are used when a signal needs to be reduced to protect measurement equipment or other circuitry, to extend the range of power meters and amplifiers, and to impedance match circuits by reducing the VSWR seen by adjacent components. RF attenuators can prevent signal overload in amplifiers, receivers and detectors, adjusting the signal level to a range that is optimal.

Few RF components are as commonly used as fixed coaxial attenuators, and Pasternack carries one of the largest in-stock varieties and ships them same day. The 1 dB Fixed Attenuator PE7AP1000-1 is rated to 1 Watt and operates from DC to 3 GHz. The versatile coaxial package uses QN male to QN female connectors and is also REACH and RoHS compliant.

Electrical Specifications

Description	Minimum	Typical	Maximum	Units
Frequency Range	DC		3	GHz
Impedance		50		Ohms
Nominal Attenuation		1		dB
Input Power, CW			1	Watts
Input Power, Peak 1 μ s, 1%			100	Watts

Specifications by Frequency

Description	F1	F2	F3	F4	F5	Units
Range	DC to 2	2 to 3				GHz
VSWR, Max	1.2:1	1.3:1				
Attenuation Accuracy, Typ	± 0.3	± 0.5				dB

Click the following link (or enter part number in "SEARCH" on website) to obtain additional part information including price, inventory and certifications: [1 dB Fixed Attenuator, QN Male to QN Female Rated to 1 Watt Up to 3 GHz PE7AP1000-1](#)



1 dB Fixed Attenuator, QN Male to QN Female Rated to 1 Watt Up to 3 GHz

RF Fixed Attenuators Technical Data Sheet

PE7AP1000-1

Mechanical Specifications

Size

Configuration

Design Fixed
Package Style Connectorized

Connectors

Description	Connector 1	Connector 2
Type	QN Male	QN Female

Mechanical Specification Notes:
Mating Life: 100 Cycles

Environmental Specifications

Temperature

Operating Range -40 to +85 deg C
Storage Range -40 to +85 deg C

Ingress Protection (IP) Rating IP67

Compliance Certifications (see [product page](#) for current document)

Plotted and Other Data

Notes:

Click the following link (or enter part number in "SEARCH" on website) to obtain additional part information including price, inventory and certifications: [1 dB Fixed Attenuator, QN Male to QN Female Rated to 1 Watt Up to 3 GHz PE7AP1000-1](#)





1 dB Fixed Attenuator, QN Male to QN Female Rated to 1 Watt Up to 3 GHz

RF Fixed Attenuators Technical Data Sheet

PE7AP1000-1

Typical Performance Data

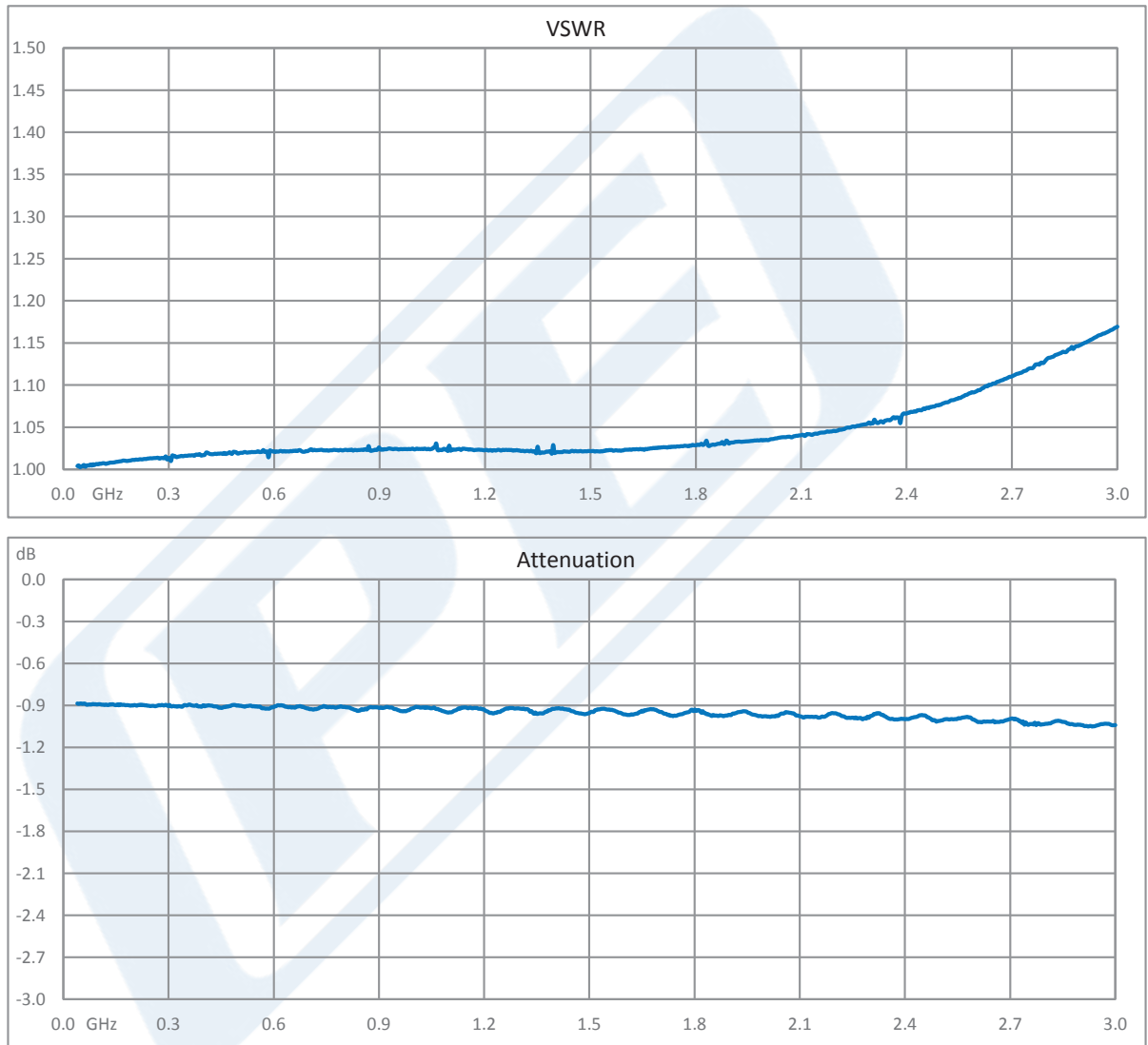

Click the following link (or enter part number in "SEARCH" on website) to obtain additional part information including price, inventory and certifications: [1 dB Fixed Attenuator, QN Male to QN Female Rated to 1 Watt Up to 3 GHz PE7AP1000-1](#)





1 dB Fixed Attenuator, QN Male to QN Female Rated to 1 Watt Up to 3 GHz

RF Fixed Attenuators Technical Data Sheet

PE7AP1000-1

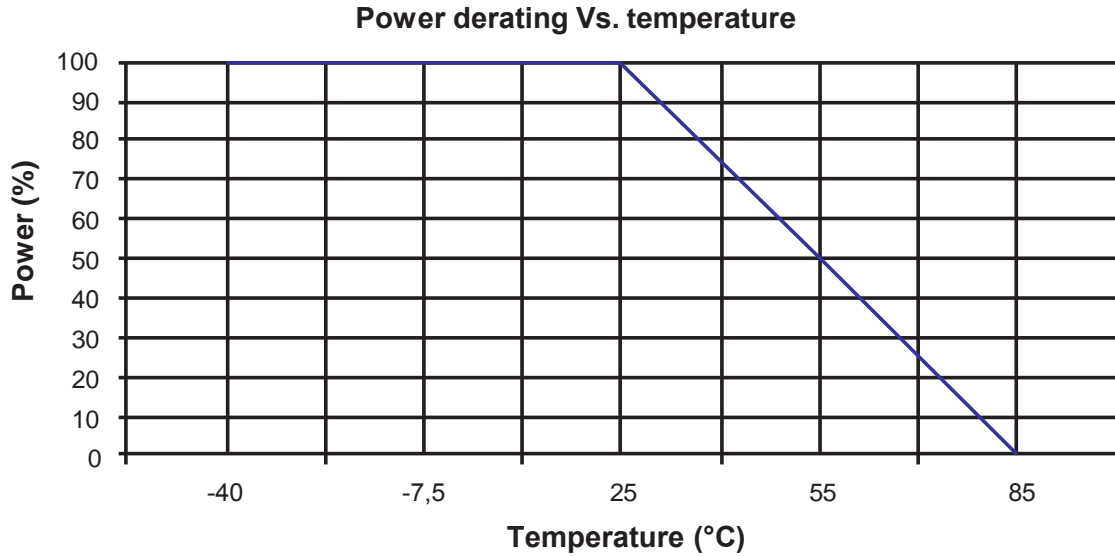

1 dB Fixed Attenuator, QN Male to QN Female Rated to 1 Watt Up to 3 GHz from Pasternack Enterprises has same day shipment for domestic and International orders. Our RF, microwave and millimeter wave products maintain a 99.4% availability and are part of the broadest selection in the industry.

Click the following link (or enter part number in "SEARCH" on website) to obtain additional part information including price, inventory and certifications: [1 dB Fixed Attenuator, QN Male to QN Female Rated to 1 Watt Up to 3 GHz PE7AP1000-1](https://www.pasternack.com/1db-fixed-qn-male-qn-female-1-watt-attenuator-pe7ap1000-1-p.aspx)

URL: <https://www.pasternack.com/1db-fixed-qn-male-qn-female-1-watt-attenuator-pe7ap1000-1-p.aspx>



PE7AP1000-1 CAD Drawing

1 dB Fixed Attenuator, QN Male to QN Female Rated to 1 Watt Up to 3 GHz

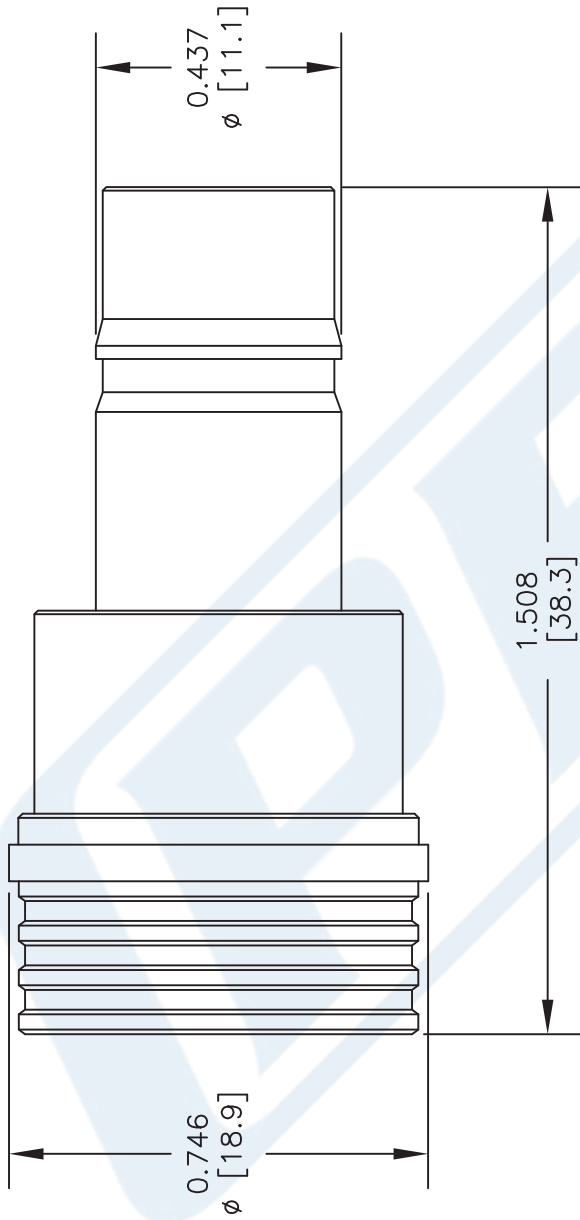

STANDARD TOLERANCES

.X ±0.2
.XX ±0.1
.XXX ±0.05

*STANDARD TOLERANCES APPLY ONLY TO DIMENSIONS IN INCHES



Pasternack Enterprises, Inc.
P.O. Box 16759 | Irvine | CA | 92623
Phone: (949) 261-1920 | Fax: (949) 261-7451
Website: www.pasternack.com | E-Mail: sales@pasternack.com

DWG TITLE

PE7AP1000-1

NOTES:
1. UNLESS OTHERWISE SPECIFIED ALL DIMENSIONS ARE NOMINAL.
2. ALL SPECIFICATIONS ARE SUBJECT TO CHANGE WITHOUT NOTICE AT ANY TIME.
3. DIMENSIONS ARE IN INCHES [mm].
4. FITS MIL-C-17 AND EQUIVALENT CABLES.

CAGE CODE 53919

CAD FILE 061317

SCALE N/A

SIZE A

2233