

High Voltage with Flexible Termination System (HV FT-CAP) X7R Dielectric, 500 – 3,000 VDC (Commercial & Automotive Grade)

Overview

KEMET's High Voltage with Flexible Termination (HV FT-CAP) surface mount MLCCs in X7R dielectric address the primary failure mode of MLCCs— flex cracks, which are typically the result of excessive tensile and shear stresses produced during board flexure and thermal cycling. Featuring several of the highest CV (capacitance/voltage) values available in the industry, these devices utilize a pliable and conductive silver epoxy between the base metal and nickel barrier layers of the termination system. The addition of this epoxy layer inhibits the transfer of board stress to the rigid ceramic body, therefore mitigating flex cracks which can result in low IR or short circuit failures. Although flexible termination technology does not eliminate the potential for mechanical damage that may propagate during extreme environmental and handling conditions, it does provide superior flex performance over standard termination systems.

The HV FT-CAP offers low leakage current, exhibits low ESR at high frequencies and finds conventional use as snubbers or filters in applications such as switching power supplies and lighting ballasts. Their exceptional performance at high frequencies has made them a preferred choice of design engineers worldwide. In addition to their use in power supplies, these capacitors are widely used in industries related to automotive(hybrid), telecommunications, medical, military, aerospace, semiconductors and test/diagnostic equipment.

Combined with the stability of an X7R dielectric and designed to accommodate all capacitance requirements, these flex-robust devices are RoHS Compliant, offer up to 5 mm of flex-bend capability and exhibits a predictable change in capacitance with respect to time and voltage. Capacitance change with reference to ambient temperature is limited to $\pm 15\%$ from -55°C to $+125^{\circ}\text{C}$.

Automotive Grade is available for applications requiring proven, reliable performance in harsh environments. Whether under-hood or in-cabin, these capacitors are designed for mission and safety critical automotive circuits. Stricter testing protocol and inspection criteria have been established for automotive grade products in recognition of potentially harsh environmental conditions. KEMET automotive grade series capacitors meet the demanding Automotive Electronics Council's AEC-Q200 qualification requirements.

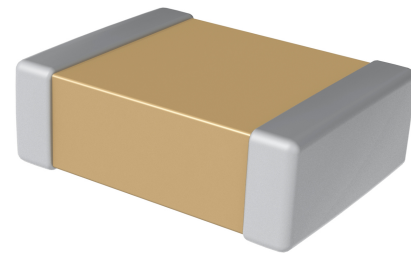

Ordering Information

| C | 1210 | X | 154 | K | C | R | A | C | TU |
|---------|--|--------------------------|--|---|---|------------|----------------------|--|---|
| Ceramic | Case Size (L" x W") | Specification/ Series | Capacitance Code (pF) | Capacitance Tolerance | Voltage | Dielectric | Failure Rate/ Design | Termination Finish ¹ | Packaging/Grade (C-Spec) ² |
| | 0805 1206 1210 1808 1812 1825 2220 2225 | X = Flexible Termination | 2 Significant Digits + Number of Zeros | J = $\pm 5\%$ K = $\pm 10\%$ M = $\pm 20\%$ | C = 500 V B = 630 V D = 1,000 V F = 1,500 V G = 2,000 V Z = 2,500 V H = 3,000 V | R = X7R | A = N/A | C = 100% Matte Sn L = SnPb (5% min) | Blank = Bulk TU = 7" Reel Unmarked TM = 7" Reel Marked |
| | | | | | | | | C = 100% Matte Sn | AUTO = Automotive Grade 7" Reel Unmarked |

¹ Additional termination finish options may be available. Contact KEMET for details.

^{1,2} SnPb termination finish option is not available on Automotive Grade product.

² Additional reeling or packaging options may be available. Contact KEMET for details.

Dimensions – Millimeters (Inches)

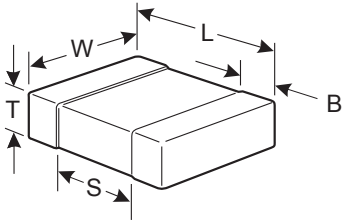

| EIA Size Code | Metric Size Code | L Length | W Width | T Thickness | B Bandwidth | S Separation Minimum | Mounting Technique |
|---------------|------------------|---------------------------|---------------------------|---------------------------|---------------------------|----------------------|------------------------------|
| 0805 | 2012 | 2.00 (.079) ± 0.20 (.008) | 1.25 (.049) ± 0.20 (.008) | See Table 2 for Thickness | 0.50 (0.02) ± 0.25 (.010) | 0.75 (.030) | Solder Wave or Solder Reflow |
| 1206 | 3216 | 3.30 (.130) ± 0.40 (.016) | 1.60 (.063) ± 0.20 (.008) | | 0.60 (.024) ± 0.25 (.010) | N/A | |
| 1210 | 3225 | 3.30 (.130) ± 0.40 (.016) | 2.50 (.098) ± 0.20 (.008) | | 0.60 (.024) ± 0.25 (.010) | | Solder Reflow Only |
| 1808 | 4520 | 4.70 (.185) ± 0.50 (.020) | 2.00 (.079) ± 0.20 (.008) | | 0.70 (.028) ± 0.35 (.014) | | |
| 1812 | 4532 | 4.50 (.178) ± 0.40 (.016) | 3.20 (.126) ± 0.30 (.012) | | 0.70 (.028) ± 0.35 (.014) | | |
| 1825 | 4564 | 4.60 (.181) ± 0.40 (.016) | 6.40 (.252) ± 0.40 (.016) | | 0.70 (.028) ± 0.35 (.014) | | |
| 2220 | 5650 | 5.90 (.232) ± 0.75 (.030) | 5.00 (.197) ± 0.40 (.016) | | 0.70 (.028) ± 0.35 (.014) | | |
| 2225 | 5664 | 5.90 (.232) ± 0.75 (.030) | 6.40 (.248) ± 0.40 (.016) | | 0.70 (.028) ± 0.35 (.014) | | |

Benefits

- -55°C to +125°C operating temperature range
- Industry-leading CV values
- Superior flex performance (up to 5 mm)
- Exceptional performance at high frequencies
- Lead (Pb)-Free, RoHS and REACH compliant
- EIA 0805, 1206, 1210, 1808, 1812, 1825, 2220, and 2225 case sizes
- DC voltage ratings of 500 V, 630 V, 1 KV, 1.5 KV, 2 KV, 2.5 KV, and 3 KV
- Capacitance offerings ranging from 130 pF to 0.33 µF
- Available capacitance tolerances of ±5%, ±10% or ±20%
- Low ESR and ESL
- Non-polar device, minimizing installation concerns
- Commercial and Automotive (AEC-Q200) Grades available
- 100% pure matte tin-plated termination finish allowing for excellent solderability
- SnPb plated termination finish option available upon request (5% minimum)

Applications

Typical applications include switch mode power supplies (input filters, resonators, tank circuits, snubber circuits, output filters), high voltage coupling and DC blocking, lighting ballasts, voltage multiplier circuits, DC/DC converters and coupling capacitors in Ćuk converters. Markets include power supply, LCD fluorescent backlight ballasts, HID lighting, telecom equipment, industrial and medical equipment/control, LAN/WAN interface, analog and digital modems, and automotive (electric and hybrid vehicles, charging stations and lighting) applications.

Application Note

X7R dielectric is not recommended for AC line filtering or pulse applications. These capacitors and/or the assembled circuit board containing these capacitors may require a protective surface coating to prevent external surface arcing.

Qualification/Certification

Commercial Grade products are subject to internal qualification. Details regarding test methods and conditions are referenced in Table 4, Performance & Reliability.

Automotive Grade products meet or exceed the requirements outlined by the Automotive Electronics Council. Details regarding test methods and conditions are referenced in document AEC-Q200, Stress Test Qualification for Passive Components. For additional information regarding the Automotive Electronics Council and AEC-Q200, please visit their website at www.aecouncil.com.

Environmental Compliance

Lead (Pb)-Free, RoHS, and REACH compliant without exemptions (excluding SnPb termination finish option).



RoHS Compliant

Electrical Parameters/Characteristics

| Item | Parameters/Characteristics |
|--|---|
| Operating Temperature Range | -55°C to +125°C |
| Capacitance Change with Reference to +25°C and 0 VDC Applied (TCC) | ±15% |
| Aging Rate (Maximum % Capacitance Loss/Decade Hour) | 3.0% |
| Dielectric Withstanding Voltage | 150% of rated voltage for voltage rating of < 1,000 V 120% of rated voltage for voltage rating of ≥ 1,000 V (5 ±1 seconds and charge/discharge not exceeding 50 mA) |
| Dissipation Factor (DF) Maximum Limit @ 25°C | 2.5% |
| Insulation Resistance (IR) Limit @ 25°C | See Insulation Resistance Limit Table (500 VDC applied for 120 ±5 seconds @ 25°C) |

Regarding aging rate: Capacitance measurements (including tolerance) are indexed to a referee time of 1,000 hours.

To obtain IR limit, divide MΩ-μF value by the capacitance and compare to GΩ limit. Select the lower of the two limits.

Capacitance and dissipation factor (DF) measured under the following conditions:

1 kHz ± 50 Hz and 1.0 ± 0.2 Vrms if capacitance ≤ 10 μF

120 Hz ± 10 Hz and 0.5 ± 0.1 Vrms if capacitance > 10 μF

Note: When measuring capacitance it is important to ensure the set voltage level is held constant. The HP4284 and Agilent E4980 have a feature known as Automatic Level Control (ALC). The ALC feature should be switched to "ON."

Post Environmental Limits

| High Temperature Life, Biased Humidity, Moisture Resistance | | | | | |
|---|------------------|-------------------|------------------------|-------------------|-----------------------|
| Dielectric | Rated DC Voltage | Capacitance Value | Dissipation Factor (%) | Capacitance Shift | Insulation Resistance |
| X7R | > 25 | All | 3.0 | ±20% | 10% of Initial Limit |
| | 16/25 | | 5.0 | | |
| | < 16 | | 7.5 | | |

Insulation Resistance Limit Table (X7R Dielectric)

| EIA Case Size | 1,000 Megohm Microfarads or 100 GΩ | 100 Megohm Microfarads or 10 GΩ |
|---------------|---------------------------------------|------------------------------------|
| 0805 | < 0.0039 μF | ≥ 0.0039 μF |
| 1206 | < 0.012 μF | ≥ 0.012 μF |
| 1210 | < 0.033 μF | ≥ 0.033 μF |
| 1808 | < 0.018 μF | ≥ 0.018 μF |
| 1812 | < 0.027 μF | ≥ 0.027 μF |
| ≥ 1825 | All | All |

Table 1A – Capacitance Range/Selection Waterfall (0805 – 1812 Case Sizes)

| Capacitance | Cap Code | Case Size/ Series | | | C0805X | | | | | C1206X | | | | | C1210X | | | | | C1808X | | | | | | C1812X | | | | | | |
|-------------|----------|-----------------------|---|---|--|-----|------|-----|-----|--------|------|------|-----|-----|--------|------|------|-----|-----|--------|------|------|------|------|-----|--------|------|------|------|------|------|--|
| | | Voltage Code | | | C | B | D | C | B | D | F | G | C | B | D | F | G | C | B | D | F | G | Z | H | C | B | D | F | G | Z | H | |
| | | Rated Voltage (VDC) | | | 500 | 630 | 1000 | 500 | 630 | 1000 | 1500 | 2000 | 500 | 630 | 1000 | 1500 | 2000 | 500 | 630 | 1000 | 1500 | 2000 | 2500 | 3000 | 500 | 630 | 1000 | 1500 | 2000 | 2500 | 3000 | |
| | | Capacitance Tolerance | | | Product Availability and Chip Thickness Codes See Table 2 for Chip Thickness Dimensions | | | | | | | | | | | | | | | | | | | | | | | | | | | |
| 120 pF | 121 | J | K | M | | | | | | | | | | | | | | | | | | | | | GG | GG | GG | GG | GG | GG | | |
| 130 pF | 131 | J | K | M | DG | DG | DG | | | | | | | | | | | LB | LB | LB | LB | LB | LB | LB | | | | | | | | |
| 150 pF | 151 | J | K | M | DG | DG | DG | | | | | | | | | | | LB | LB | LB | LB | LB | LB | LB | | | | | | | | |
| 180 pF | 181 | J | K | M | DG | DG | DG | | | | | | | | | | | LB | LB | LB | LB | LB | LB | LB | | | | | | | | |
| 220 pF | 221 | J | K | M | DG | DG | DG | EG | EG | EG | EG | EG | | | | | | LB | LB | LB | LB | LB | LB | LB | GK | GK | GK | GK | GK | GK | GK | |
| 270 pF | 271 | J | K | M | DG | DG | DG | EG | EG | EG | EG | EG | | | | | | LC | LC | LC | LC | LC | LC | LC | GK | GK | GK | GK | GK | GK | GK | |
| 330 pF | 331 | J | K | M | DG | DG | DG | EG | EG | EG | EG | EG | | | | | | LC | LC | LC | LC | LC | LC | LC | GK | GK | GK | GK | GK | GK | GK | |
| 390 pF | 391 | J | K | M | DG | DG | DG | EG | EG | EG | EG | EG | | | | | | LB | LB | LB | LB | LB | LB | LB | GK | GK | GK | GK | GK | GK | GK | |
| 470 pF | 471 | J | K | M | DG | DG | DG | EF | EF | EF | EF | EG | | | | | | LB | LB | LB | LB | LB | LB | LB | GK | GK | GK | GK | GK | GK | GK | |
| 560 pF | 561 | J | K | M | DG | DG | DG | EF | EF | EF | EF | EG | | | | | | LB | LB | LB | LB | LB | LB | LB | GK | GK | GK | GK | GK | GK | GK | |
| 680 pF | 681 | J | K | M | DG | DG | DG | EF | EF | EF | EF | EG | FL | FL | FL | FL | FL | LA | LA | LA | LA | LB | LB | LB | GH | GH | GH | GH | GH | GH | GH | |
| 820 pF | 821 | J | K | M | DG | DG | DG | EF | EF | EF | EF | EG | FL | FL | FL | FL | FL | LA | LA | LA | LA | LB | LB | LB | GH | GH | GH | GH | GH | GH | GH | |
| 1,000 pF | 102 | J | K | M | DG | DG | DG | EF | EF | EF | EF | EG | FL | FL | FL | FL | FL | LA | LA | LA | LA | LB | LB | LB | GH | GH | GH | GH | GH | GH | GH | |
| 1,200 pF | 122 | J | K | M | DG | DG | DG | EF | EF | EF | EG | EG | FL | FL | FL | FL | FM | LB | LB | LB | LB | LB | LB | LB | GH | GH | GH | GH | GH | GH | GH | |
| 1,500 pF | 152 | J | K | M | DG | DG | DG | EF | EF | EF | EG | EG | FL | FL | FL | FL | FM | LB | LB | LB | LB | LB | LB | LB | GH | GH | GH | GH | GH | GH | GH | |
| 1,800 pF | 182 | J | K | M | DG | DG | DG | EF | EF | EF | EG | EG | FL | FL | FL | FL | FM | LB | LB | LB | LB | LB | LB | LB | GH | GH | GH | GH | GH | GH | GH | |
| 2,000 pF | 202 | J | K | M | DG | DG | DG | EF | EF | EF | EG | EG | FL | FL | FL | FL | FM | LA | LA | LA | LA | LB | LB | LB | GH | GH | GH | GH | GH | GH | GH | |
| 2,200 pF | 222 | J | K | M | DG | DG | DG | EF | EF | EF | EG | EG | FL | FL | FL | FL | FM | LA | LA | LA | LA | LB | LB | LB | GH | GH | GH | GH | GH | GH | GH | |
| 2,700 pF | 272 | J | K | M | DG | DG | DG | EF | EF | EF | EG | EG | FL | FL | FL | FL | FM | LA | LA | LA | LA | LB | LB | LB | GH | GH | GH | GH | GH | GH | GH | |
| 3,300 pF | 332 | J | K | M | DG | DG | DG | EF | EF | EF | EG | EG | FL | FL | FL | FL | FM | LA | LA | LA | LA | LB | LB | LB | GH | GH | GH | GH | GH | GH | GH | |
| 3,900 pF | 392 | J | K | M | DG | DG | DG | EF | EF | EF | EG | EG | FL | FL | FL | FL | FK | LA | LA | LA | LA | LB | LB | LB | GH | GH | GH | GH | GH | GH | GH | |
| 4,700 pF | 472 | J | K | M | DG | DG | DG | EF | EF | EF | EG | EG | FL | FL | FL | FL | FK | LA | LA | LA | LA | LB | LB | LB | GH | GH | GH | GH | GH | GH | GH | |
| 5,600 pF | 562 | J | K | M | DG | DG | | EF | EF | EF | EG | EG | FL | FL | FL | FL | FK | LA | LA | LA | LA | LB | LB | LB | GH | GH | GH | GH | GH | GH | GH | |
| 6,800 pF | 682 | J | K | M | DG | DG | | EG | EG | EG | EF | EF | FL | FL | FL | FM | FS | LA | LB | LB | LB | LB | LB | LB | GH | GH | GH | GK | GM | | | |
| 8,200 pF | 822 | J | K | M | DG | DG | | EG | EG | EG | EF | EF | FL | FL | FL | FK | | LA | LB | LB | LB | LB | LB | LB | GH | GH | GH | GK | GM | | | |
| 10,000 pF | 103 | J | K | M | DG | | | EG | EG | EG | EG | EG | FL | FL | FL | FK | | LA | LB | LB | LB | LB | LB | LB | GH | GH | GH | GK | GO | | | |
| 12,000 pF | 123 | J | K | M | DG | | | EG | EJ | EJ | | | FL | FL | FL | FK | | LA | LC | LC | LC | LB | LB | LB | GH | GK | GK | GK | | | | |
| 15,000 pF | 153 | J | K | M | | | | EG | EJ | EJ | | | FL | FL | FL | FL | | LA | LC | LC | LC | | | | GH | GK | GK | GH | | | | |
| 18,000 pF | 183 | J | K | M | | | | EJ | EJ | EJ | | | FL | FL | FL | FM | | LA | LE | LE | | | | | GH | GK | GK | GM | | | | |
| 22,000 pF | 223 | J | K | M | | | | EJ | EJ | EJ | | | FL | FL | FM | FM | | LA | LE | LE | | | | | GH | GK | GK | GM | | | | |
| 27,000 pF | 273 | J | K | M | | | | EJ | EJ | | | | FM | FK | FK | FK | | LA | LA | LA | | | | | GH | GB | GB | GO | | | | |
| 33,000 pF | 333 | J | K | M | | | | EJ | EJ | | | | FM | FG | FH | FS | | LC | LA | LA | | | | | GH | GB | GB | GO | | | | |
| 39,000 pF | 393 | J | K | M | | | | EJ | | | | | FK | FG | FH | FS | | LC | LA | LA | | | | | GH | GB | GB | | | | | |
| 47,000 pF | 473 | J | K | M | | | | EJ | | | | | FK | FH | FK | | | LC | LA | LB | | | | | GH | GB | GC | | | | | |
| 56,000 pF | 563 | J | K | M | | | | EJ | | | | | FG | FH | FK | | | LC | LA | LB | | | | | GH | GB | GE | | | | | |
| 62,000 pF | 623 | J | K | M | | | | EJ | | | | | FG | FK | FS | | | LA | LA | LC | | | | | GK | GB | GE | | | | | |
| 68,000 pF | 683 | J | K | M | | | | EJ | | | | | FG | FK | FS | | | LA | LA | LC | | | | | GE | GE | GE | | | | | |
| 82,000 pF | 823 | J | K | M | | | | | | | | | FH | FK | | | | LA | LC | | | | | | GB | GE | GK | | | | | |
| 0.10 μF | 104 | J | K | M | | | | | | | | | FK | FS | | | | LA | LC | | | | | | GB | GH | GJ | | | | | |
| 0.12 μF | 124 | J | K | M | | | | | | | | | FK | | | | | LA | | | | | | | GE | GK | | | | | | |
| 0.15 μF | 154 | J | K | M | | | | | | | | | FK | | | | | LB | | | | | | | GE | GN | | | | | | |
| 0.18 μF | 184 | J | K | M | | | | | | | | | | | | | | | | | | | | | GF | | | | | | | |
| 0.22 μF | 224 | J | K | M | | | | | | | | | | | | | | | | | | | | | GJ | | | | | | | |
| 0.27 μF | 274 | J | K | M | | | | | | | | | | | | | | | | | | | | | GL | | | | | | | |
| 0.33 μF | 334 | J | K | M | | | | | | | | | | | | | | | | | | | | | GS | | | | | | | |

KEMET reserves the right to substitute product with an improved temperature characteristic, tighter capacitance tolerance and/or higher voltage capability within the same form factor (configuration and dimensions).

Table 1B – Capacitance Range/Selection Waterfall (1825 – 2225 Case Sizes)

| Capacitance | Cap Code | Case Size/ Series | | | C1825X | | | | | | | | C2220X | | | | | | | | C2225X | | | | | | | | | | | | | | | | | | | | | | | | | | | | | | | | | | | | | | | | | | | | | | | | | | | | | | | | | | | | | | | | | | | | | | | | | | | | | | | | | | | | | | | | | | | | | | | | | | | | | | | | | | | | | | | | | | | | | | | | | | | | | | | | | | | | | | | | | | | | | | | | | | | | | | | | | | | | | | | | | | | | | | | | | | | | | | | | | | | | | | | | | | | | | | | | | | | | | | | | | | | | | | | | | | | | | | | | | | | | | | | | | | | | | | | | | | | | | | | | | | | | | | | | | | | | | | | | | | | | | | | | | | | | | | | | | | | | | | | | | | | | | | | | | | | | | | | | | | | | | | | | | | | | | | | | | | | | | | | | | | | | | | | | | | | | | | | | | | | | | | | | | | | | | | | | | | | | | | | | | | | | | | | | | | | | | | | | | | | | | | | | | | | | | | | | | | | | | | | | | | | | | | | | | | | | | | | | | | | | | | | | | | | | | | | | | | | | | | | | | | | | | | | | | | | | | | | | | | | | | | | | | | | | | | | | | | | | | | | | | | | | | | | | | | | | | | | | | | | | | | | | | | | | | | | | | | | | | | | | | | | | | | | | | | | | | | | | | | | | | | | | | | | | | | | | | | | | | | | | | | | | | | | | | | | | | | | | | | | | | | | | | | | | | | | | | | | | | | | | | | | | | | | | | | | | | | | | | | | | | | | | | | | | | | | | | | | | | | | | | | | | | | | | | | | | | | | | | | | | | | | | | | | | | | | | | | | | | | | | | | | | | | | | | | | | | | | | | | | | | | | | | | | | | | | | | | | | | | | | | | | | | | | | | | | | | | | | | | | | | | | | | | | | | | | | | | | | | | | | | | | | | | | | | | | | | | | | | | | | | | | | | | | | | | | | | | | | | | | | | | | | | | | | | | | | | | | | | | | | | | | | | | | | | | | | | | | | | | | | | | | | | | | | | | | | | |
|-------------|----------|-----------------------|---|---|--|-----|------|------|------|------|------|-----|--------|------|------|------|------|------|-----|-----|--------|------|------|------|-----------|-----|---|---|---|----|----|----|----|----|----|----|----|----|----|----|----|----|----|----|----|----|----|----|----|-----------|-----|---|---|---|----|----|----|----|----|----|----|----|----|----|----|----|----|----|----|----|----|----|----|----|-----------|-----|---|---|---|----|----|----|----|----|----|----|----|----|----|----|----|----|----|----|----|----|----|----|----|-----------|-----|---|---|---|----|----|----|----|----|----|----|----|----|----|----|----|----|----|----|----|----|----|----|----|-----------|-----|---|---|---|----|----|----|----|----|----|----|----|----|----|----|----|----|----|----|----|----|----|----|----|-----------|-----|---|---|---|----|----|----|----|----|----|----|----|----|----|----|----|----|----|----|----|----|----|----|----|-----------|-----|---|---|---|----|----|----|----|----|----|----|----|----|----|----|----|----|----|----|----|----|----|----|----|-----------|-----|---|---|---|----|----|----|----|----|----|----|----|----|----|----|----|----|----|----|----|----|----|----|----|-----------|-----|---|---|---|----|----|----|----|----|----|----|----|----|----|----|----|----|----|----|----|----|----|----|----|-----------|-----|---|---|---|----|----|----|----|----|----|----|----|----|----|----|----|----|----|----|----|----|----|----|----|-----------|-----|---|---|---|----|----|----|----|----|----|----|----|----|----|----|----|----|----|----|----|----|----|----|----|-----------|-----|---|---|---|----|----|----|----|----|----|--|----|----|----|----|----|----|----|----|----|----|----|----|----|-----------|-----|---|---|---|----|----|----|----|----|----|--|----|----|----|----|----|----|----|----|----|----|----|----|----|-----------|-----|---|---|---|----|----|----|----|----|----|--|----|----|----|----|----|----|----|----|----|----|----|----|----|-----------|-----|---|---|---|----|----|----|----|----|----|--|----|----|----|----|----|----|----|----|----|----|----|----|----|-----------|-----|---|---|---|----|----|----|----|----|----|--|----|----|----|----|----|----|----|----|----|----|----|----|----|-----------|-----|---|---|---|----|----|----|----|----|----|--|----|----|----|----|----|----|----|----|----|----|----|----|----|-----------|-----|---|---|---|----|----|----|----|----|--|--|----|----|----|----|----|----|----|----|----|----|----|----|----|-----------|-----|---|---|---|----|----|----|----|----|--|--|----|----|----|----|----|----|----|----|----|----|----|----|----|-----------|-----|---|---|---|----|----|----|----|--|--|--|----|----|----|----|----|--|----|----|----|----|----|--|--|-----------|-----|---|---|---|----|----|----|----|--|--|--|----|----|----|----|----|--|----|----|----|----|----|--|--|-----------|-----|---|---|---|----|----|----|----|--|--|--|----|----|----|----|--|--|----|----|----|----|----|--|--|-----------|-----|---|---|---|----|----|----|----|--|--|--|----|----|----|----|--|--|----|----|----|----|--|--|--|-----------|-----|---|---|---|----|----|----|----|--|--|--|----|----|----|----|--|--|----|----|----|----|--|--|--|-----------|-----|---|---|---|----|----|----|----|--|--|--|----|----|----|----|--|--|----|----|----|----|--|--|--|-----------|-----|---|---|---|----|----|----|----|--|--|--|----|----|----|----|--|--|----|----|----|----|--|--|--|-----------|-----|---|---|---|----|----|----|----|--|--|--|----|----|----|----|--|--|----|----|----|----|--|--|--|-----------|-----|---|---|---|----|----|----|----|--|--|--|----|----|----|----|--|--|----|----|----|----|--|--|--|-----------|-----|---|---|---|----|----|----|--|--|--|--|----|----|----|----|--|--|----|----|----|----|--|--|--|---------|-----|---|---|---|----|----|----|--|--|--|--|----|----|----|--|--|--|----|----|----|----|--|--|--|---------|-----|---|---|---|----|--|--|--|--|--|--|----|----|----|--|--|--|----|----|----|----|--|--|--|---------|-----|---|---|---|----|--|--|--|--|--|--|----|--|--|--|--|--|----|----|----|--|--|--|--|---------|-----|---|---|---|----|--|--|--|--|--|--|----|--|--|--|--|--|----|--|--|--|--|--|--|---------|-----|---|---|---|----|--|--|--|--|--|--|--|--|--|--|--|--|----|--|--|--|--|--|--|
| | | Voltage Code | | | C | B | D | F | G | Z | H | C | B | D | F | G | Z | H | C | B | D | F | G | Z | H | | | | | | | | | | | | | | | | | | | | | | | | | | | | | | | | | | | | | | | | | | | | | | | | | | | | | | | | | | | | | | | | | | | | | | | | | | | | | | | | | | | | | | | | | | | | | | | | | | | | | | | | | | | | | | | | | | | | | | | | | | | | | | | | | | | | | | | | | | | | | | | | | | | | | | | | | | | | | | | | | | | | | | | | | | | | | | | | | | | | | | | | | | | | | | | | | | | | | | | | | | | | | | | | | | | | | | | | | | | | | | | | | | | | | | | | | | | | | | | | | | | | | | | | | | | | | | | | | | | | | | | | | | | | | | | | | | | | | | | | | | | | | | | | | | | | | | | | | | | | | | | | | | | | | | | | | | | | | | | | | | | | | | | | | | | | | | | | | | | | | | | | | | | | | | | | | | | | | | | | | | | | | | | | | | | | | | | | | | | | | | | | | | | | | | | | | | | | | | | | | | | | | | | | | | | | | | | | | | | | | | | | | | | | | | | | | | | | | | | | | | | | | | | | | | | | | | | | | | | | | | | | | | | | | | | | | | | | | | | | | | | | | | | | | | | | | | | | | | | | | | | | | | | | | | | | | | | | | | | | | | | | | | | | | | | | | | | | | | | | | | | | | | | | | | | | | | | | | | | | | | | | | | | | | | | | | | | | | | | | | | | | | | | | | | | | | | | | | | | | | | | | | | | | | | | | | | | | | | | | | | | | | | | | | | | | | | | | | | | | | | | | | | | | | | | | | | | | | | | | | | | | | | | | | | | | | | | | | | | | | | | | | | | | | | | | | | | | | | | | | | | | | | | | | | | | | | | | | | | | | | | | | | | | | | | | | | | | | | | | | | | | | | | | | | | | | | | | | | | | | | | | | | | | | | | | | | | | | | | | | | | | | | | | | | | | | | | | | | | | | | | | | | | | | | | | | | | | | | | | | | | | | | | | | | | | | | | | | | | | | | | | | | | | | |
| | | Rated Voltage (VDC) | | | 500 | 630 | 1000 | 1500 | 2000 | 2500 | 3000 | 500 | 630 | 1000 | 1500 | 2000 | 2500 | 3000 | 500 | 630 | 1000 | 1500 | 2000 | 2500 | 3000 | | | | | | | | | | | | | | | | | | | | | | | | | | | | | | | | | | | | | | | | | | | | | | | | | | | | | | | | | | | | | | | | | | | | | | | | | | | | | | | | | | | | | | | | | | | | | | | | | | | | | | | | | | | | | | | | | | | | | | | | | | | | | | | | | | | | | | | | | | | | | | | | | | | | | | | | | | | | | | | | | | | | | | | | | | | | | | | | | | | | | | | | | | | | | | | | | | | | | | | | | | | | | | | | | | | | | | | | | | | | | | | | | | | | | | | | | | | | | | | | | | | | | | | | | | | | | | | | | | | | | | | | | | | | | | | | | | | | | | | | | | | | | | | | | | | | | | | | | | | | | | | | | | | | | | | | | | | | | | | | | | | | | | | | | | | | | | | | | | | | | | | | | | | | | | | | | | | | | | | | | | | | | | | | | | | | | | | | | | | | | | | | | | | | | | | | | | | | | | | | | | | | | | | | | | | | | | | | | | | | | | | | | | | | | | | | | | | | | | | | | | | | | | | | | | | | | | | | | | | | | | | | | | | | | | | | | | | | | | | | | | | | | | | | | | | | | | | | | | | | | | | | | | | | | | | | | | | | | | | | | | | | | | | | | | | | | | | | | | | | | | | | | | | | | | | | | | | | | | | | | | | | | | | | | | | | | | | | | | | | | | | | | | | | | | | | | | | | | | | | | | | | | | | | | | | | | | | | | | | | | | | | | | | | | | | | | | | | | | | | | | | | | | | | | | | | | | | | | | | | | | | | | | | | | | | | | | | | | | | | | | | | | | | | | | | | | | | | | | | | | | | | | | | | | | | | | | | | | | | | | | | | | | | | | | | | | | | | | | | | | | | | | | | | | | | | | | | | | | | | | | | | | | | | | | | | | | | | | | | | | | | | | | | | | | | | | | | | | | | | | | | | | | | | | | | | | | | | | | | | | | | | | | | | | | | | | | | | | | | | | | | | | | | | | |
| | | Capacitance Tolerance | | | Product Availability and Chip Thickness Codes See Table 2 for Chip Thickness Dimensions | | | | | | | | | | | | | | | | | | | | | | | | | | | | | | | | | | | | | | | | | | | | | | | | | | | | | | | | | | | | | | | | | | | | | | | | | | | | | | | | | | | | | | | | | | | | | | | | | | | | | | | | | | | | | | | | | | | | | | | | | | | | | | | | | | | | | | | | | | | | | | | | | | | | | | | | | | | | | | | | | | | | | | | | | | | | | | | | | | | | | | | | | | | | | | | | | | | | | | | | | | | | | | | | | | | | | | | | | | | | | | | | | | | | | | | | | | | | | | | | | | | | | | | | | | | | | | | | | | | | | | | | | | | | | | | | | | | | | | | | | | | | | | | | | | | | | | | | | | | | | | | | | | | | | | | | | | | | | | | | | | | | | | | | | | | | | | | | | | | | | | | | | | | | | | | | | | | | | | | | | | | | | | | | | | | | | | | | | | | | | | | | | | | | | | | | | | | | | | | | | | | | | | | | | | | | | | | | | | | | | | | | | | | | | | | | | | | | | | | | | | | | | | | | | | | | | | | | | | | | | | | | | | | | | | | | | | | | | | | | | | | | | | | | | | | | | | | | | | | | | | | | | | | | | | | | | | | | | | | | | | | | | | | | | | | | | | | | | | | | | | | | | | | | | | | | | | | | | | | | | | | | | | | | | | | | | | | | | | | | | | | | | | | | | | | | | | | | | | | | | | | | | | | | | | | | | | | | | | | | | | | | | | | | | | | | | | | | | | | | | | | | | | | | | | | | | | | | | | | | | | | | | | | | | | | | | | | | | | | | | | | | | | | | | | | | | | | | | | | | | | | | | | | | | | | | | | | | | | | | | | | | | | | | | | | | | | | | | | | | | | | | | | | | | | | | | | | | | | | | | | | | | | | | | | | | | | | | | | | | | | | | | | | | | | | | | | | | | | | | | | | | | | | | | | | | | | | | | | | | | | | | | | | | | | | | | | | | | | | | | | | | | | | | | | | | | | | | | | | | | | | | | | | | | |
| 470 pF | 471 | J | K | M | HG | HG | HG | HG | HG | HG | HG | JK | JK | JK | JK | JK | JK | | | | | | | | 560 pF | 561 | J | K | M | HG | HG | HG | HG | HG | HG | HG | JK | JK | JK | JK | JK | JK | KF | KF | KF | KF | KF | KF | KF | 680 pF | 681 | J | K | M | HG | HG | HG | HG | HG | HG | HG | JK | JK | JK | JK | JK | JK | KF | KF | KF | KF | KF | KF | KF | 820 pF | 821 | J | K | M | HG | HG | HG | HG | HG | HG | HG | JK | JK | JK | JK | JK | JK | KF | KF | KF | KF | KF | KF | KF | 1,000 pF | 102 | J | K | M | HG | HG | HG | HG | HG | HG | HG | JK | JK | JK | JK | JK | JK | KF | KF | KF | KF | KF | KF | KF | 1,200 pF | 122 | J | K | M | HG | HG | HG | HG | HG | HG | HG | JK | JK | JK | JK | JK | JK | KF | KF | KF | KF | KF | KF | KF | 1,500 pF | 152 | J | K | M | HG | HG | HG | HG | HG | HG | HG | JK | JK | JK | JK | JK | JK | KF | KF | KF | KF | KF | KF | KF | 1,800 pF | 182 | J | K | M | HE | HE | HE | HE | HE | HG | HG | JK | JK | JK | JK | JK | JK | KF | KF | KF | KF | KF | KF | KF | 2,000 pF | 202 | J | K | M | HE | HE | HE | HE | HE | HG | HG | JE | JE | JE | JE | JE | JK | KF | KF | KF | KF | KF | KF | KF | 2,200 pF | 222 | J | K | M | HE | HE | HE | HE | HE | HG | HG | JE | JE | JE | JE | JE | JK | KF | KF | KF | KF | KF | KF | KF | 2,700 pF | 272 | J | K | M | HE | HE | HE | HE | HE | HG | HG | JE | JE | JE | JE | JE | JK | KE | KE | KE | KE | KE | KF | KE | 3,300 pF | 332 | J | K | M | HE | HE | HE | HE | HE | HG | HG | JE | JE | JE | JE | JE | JK | KE | KE | KE | KE | KE | KF | KE | 3,900 pF | 392 | J | K | M | HE | HE | HE | HE | HE | HG | | JE | JE | JE | JE | JE | JK | KE | KE | KE | KE | KE | KF | KE | 4,700 pF | 472 | J | K | M | HE | HE | HE | HE | HE | HG | | JE | JE | JE | JE | JK | JE | KE | KE | KE | KE | KE | KF | KE | 5,600 pF | 562 | J | K | M | HE | HE | HE | HE | HE | HG | | JE | JE | JE | JE | JK | JE | KE | KE | KE | KE | KE | KF | KE | 6,800 pF | 682 | J | K | M | HE | HE | HE | HE | HE | HJ | | JE | JE | JE | JE | JK | JE | KE | KE | KE | KE | KF | KE | KE | 8,200 pF | 822 | J | K | M | HE | HE | HE | HE | HE | HJ | | JE | JE | JE | JE | JK | JK | KE | KE | KE | KE | KF | KF | KF | 10,000 pF | 103 | J | K | M | HE | HE | HE | HE | HJ | HK | | JE | JE | JE | JE | JL | JL | KE | KE | KE | KE | KF | KH | KH | 12,000 pF | 123 | J | K | M | HE | HE | HE | HG | HJ | | | JE | JK | JK | JK | JL | JL | KE | KE | KE | KE | KF | KH | KH | 15,000 pF | 153 | J | K | M | HE | HE | HE | HG | HK | | | JE | JK | JK | JK | JN | JN | KE | KE | KE | KE | KF | KJ | KJ | 18,000 pF | 183 | J | K | M | HE | HE | HE | HG | | | | JE | JK | JK | JK | JN | | KE | KE | KE | KE | KH | | | 22,000 pF | 223 | J | K | M | HE | HG | HG | HG | | | | JE | JK | JK | JK | JN | | KE | KF | KF | KF | KJ | | | 27,000 pF | 273 | J | K | M | HE | HG | HG | HG | | | | JE | JK | JK | JK | | | KE | KF | KF | KF | KJ | | | 33,000 pF | 333 | J | K | M | HE | HG | HG | HE | | | | JE | JK | JK | JK | | | KE | KF | KF | KF | | | | 39,000 pF | 393 | J | K | M | HE | HG | HG | HG | | | | JE | JK | JK | JE | | | KE | KF | KF | KF | | | | 47,000 pF | 473 | J | K | M | HE | HG | HG | HJ | | | | JE | JK | JK | JK | | | KE | KF | KF | KF | | | | 56,000 pF | 563 | J | K | M | HE | HG | HG | HJ | | | | JE | JE | JE | JL | | | KE | KF | KF | KF | | | | 62,000 pF | 623 | J | K | M | HG | HG | HG | HK | | | | JE | JE | JE | JL | | | KF | KF | KF | KH | | | | 68,000 pF | 683 | J | K | M | HG | HJ | HJ | HK | | | | JE | JK | JK | JL | | | KE | KF | KF | KJ | | | | 82,000 pF | 823 | J | K | M | HG | HJ | HJ | | | | | JE | JL | JL | JN | | | KE | KF | KF | KJ | | | | 0.10 µF | 104 | J | K | M | HG | HK | HK | | | | | JE | JN | JN | | | | KE | KH | KH | KJ | | | | 0.12 µF | 124 | J | K | M | HG | | | | | | | JE | JN | JN | | | | KE | KH | KH | KJ | | | | 0.15 µF | 154 | J | K | M | HG | | | | | | | JK | | | | | | KF | KJ | KJ | | | | | 0.18 µF | 184 | J | K | M | HG | | | | | | | JK | | | | | | KF | | | | | | | 0.22 µF | 224 | J | K | M | HG | | | | | | | | | | | | | KF | | | | | | |
| 560 pF | 561 | J | K | M | HG | HG | HG | HG | HG | HG | HG | JK | JK | JK | JK | JK | JK | KF | KF | KF | KF | KF | KF | KF | 680 pF | 681 | J | K | M | HG | HG | HG | HG | HG | HG | HG | JK | JK | JK | JK | JK | JK | KF | KF | KF | KF | KF | KF | KF | 820 pF | 821 | J | K | M | HG | HG | HG | HG | HG | HG | HG | JK | JK | JK | JK | JK | JK | KF | KF | KF | KF | KF | KF | KF | 1,000 pF | 102 | J | K | M | HG | HG | HG | HG | HG | HG | HG | JK | JK | JK | JK | JK | JK | KF | KF | KF | KF | KF | KF | KF | 1,200 pF | 122 | J | K | M | HG | HG | HG | HG | HG | HG | HG | JK | JK | JK | JK | JK | JK | KF | KF | KF | KF | KF | KF | KF | 1,500 pF | 152 | J | K | M | HG | HG | HG | HG | HG | HG | HG | JK | JK | JK | JK | JK | JK | KF | KF | KF | KF | KF | KF | KF | 1,800 pF | 182 | J | K | M | HE | HE | HE | HE | HE | HG | HG | JK | JK | JK | JK | JK | JK | KF | KF | KF | KF | KF | KF | KF | 2,000 pF | 202 | J | K | M | HE | HE | HE | HE | HE | HG | HG | JE | JE | JE | JE | JE | JK | KF | KF | KF | KF | KF | KF | KF | 2,200 pF | 222 | J | K | M | HE | HE | HE | HE | HE | HG | HG | JE | JE | JE | JE | JE | JK | KF | KF | KF | KF | KF | KF | KF | 2,700 pF | 272 | J | K | M | HE | HE | HE | HE | HE | HG | HG | JE | JE | JE | JE | JE | JK | KE | KE | KE | KE | KE | KF | KE | 3,300 pF | 332 | J | K | M | HE | HE | HE | HE | HE | HG | HG | JE | JE | JE | JE | JE | JK | KE | KE | KE | KE | KE | KF | KE | 3,900 pF | 392 | J | K | M | HE | HE | HE | HE | HE | HG | | JE | JE | JE | JE | JE | JK | KE | KE | KE | KE | KE | KF | KE | 4,700 pF | 472 | J | K | M | HE | HE | HE | HE | HE | HG | | JE | JE | JE | JE | JK | JE | KE | KE | KE | KE | KE | KF | KE | 5,600 pF | 562 | J | K | M | HE | HE | HE | HE | HE | HG | | JE | JE | JE | JE | JK | JE | KE | KE | KE | KE | KE | KF | KE | 6,800 pF | 682 | J | K | M | HE | HE | HE | HE | HE | HJ | | JE | JE | JE | JE | JK | JE | KE | KE | KE | KE | KF | KE | KE | 8,200 pF | 822 | J | K | M | HE | HE | HE | HE | HE | HJ | | JE | JE | JE | JE | JK | JK | KE | KE | KE | KE | KF | KF | KF | 10,000 pF | 103 | J | K | M | HE | HE | HE | HE | HJ | HK | | JE | JE | JE | JE | JL | JL | KE | KE | KE | KE | KF | KH | KH | 12,000 pF | 123 | J | K | M | HE | HE | HE | HG | HJ | | | JE | JK | JK | JK | JL | JL | KE | KE | KE | KE | KF | KH | KH | 15,000 pF | 153 | J | K | M | HE | HE | HE | HG | HK | | | JE | JK | JK | JK | JN | JN | KE | KE | KE | KE | KF | KJ | KJ | 18,000 pF | 183 | J | K | M | HE | HE | HE | HG | | | | JE | JK | JK | JK | JN | | KE | KE | KE | KE | KH | | | 22,000 pF | 223 | J | K | M | HE | HG | HG | HG | | | | JE | JK | JK | JK | JN | | KE | KF | KF | KF | KJ | | | 27,000 pF | 273 | J | K | M | HE | HG | HG | HG | | | | JE | JK | JK | JK | | | KE | KF | KF | KF | KJ | | | 33,000 pF | 333 | J | K | M | HE | HG | HG | HE | | | | JE | JK | JK | JK | | | KE | KF | KF | KF | | | | 39,000 pF | 393 | J | K | M | HE | HG | HG | HG | | | | JE | JK | JK | JE | | | KE | KF | KF | KF | | | | 47,000 pF | 473 | J | K | M | HE | HG | HG | HJ | | | | JE | JK | JK | JK | | | KE | KF | KF | KF | | | | 56,000 pF | 563 | J | K | M | HE | HG | HG | HJ | | | | JE | JE | JE | JL | | | KE | KF | KF | KF | | | | 62,000 pF | 623 | J | K | M | HG | HG | HG | HK | | | | JE | JE | JE | JL | | | KF | KF | KF | KH | | | | 68,000 pF | 683 | J | K | M | HG | HJ | HJ | HK | | | | JE | JK | JK | JL | | | KE | KF | KF | KJ | | | | 82,000 pF | 823 | J | K | M | HG | HJ | HJ | | | | | JE | JL | JL | JN | | | KE | KF | KF | KJ | | | | 0.10 µF | 104 | J | K | M | HG | HK | HK | | | | | JE | JN | JN | | | | KE | KH | KH | KJ | | | | 0.12 µF | 124 | J | K | M | HG | | | | | | | JE | JN | JN | | | | KE | KH | KH | KJ | | | | 0.15 µF | 154 | J | K | M | HG | | | | | | | JK | | | | | | KF | KJ | KJ | | | | | 0.18 µF | 184 | J | K | M | HG | | | | | | | JK | | | | | | KF | | | | | | | 0.22 µF | 224 | J | K | M | HG | | | | | | | | | | | | | KF | | | | | | | | | | | | | | | | | | | | | | | | | | | | | | | |
| 680 pF | 681 | J | K | M | HG | HG | HG | HG | HG | HG | HG | JK | JK | JK | JK | JK | JK | KF | KF | KF | KF | KF | KF | KF | 820 pF | 821 | J | K | M | HG | HG | HG | HG | HG | HG | HG | JK | JK | JK | JK | JK | JK | KF | KF | KF | KF | KF | KF | KF | 1,000 pF | 102 | J | K | M | HG | HG | HG | HG | HG | HG | HG | JK | JK | JK | JK | JK | JK | KF | KF | KF | KF | KF | KF | KF | 1,200 pF | 122 | J | K | M | HG | HG | HG | HG | HG | HG | HG | JK | JK | JK | JK | JK | JK | KF | KF | KF | KF | KF | KF | KF | 1,500 pF | 152 | J | K | M | HG | HG | HG | HG | HG | HG | HG | JK | JK | JK | JK | JK | JK | KF | KF | KF | KF | KF | KF | KF | 1,800 pF | 182 | J | K | M | HE | HE | HE | HE | HE | HG | HG | JK | JK | JK | JK | JK | JK | KF | KF | KF | KF | KF | KF | KF | 2,000 pF | 202 | J | K | M | HE | HE | HE | HE | HE | HG | HG | JE | JE | JE | JE | JE | JK | KF | KF | KF | KF | KF | KF | KF | 2,200 pF | 222 | J | K | M | HE | HE | HE | HE | HE | HG | HG | JE | JE | JE | JE | JE | JK | KF | KF | KF | KF | KF | KF | KF | 2,700 pF | 272 | J | K | M | HE | HE | HE | HE | HE | HG | HG | JE | JE | JE | JE | JE | JK | KE | KE | KE | KE | KE | KF | KE | 3,300 pF | 332 | J | K | M | HE | HE | HE | HE | HE | HG | HG | JE | JE | JE | JE | JE | JK | KE | KE | KE | KE | KE | KF | KE | 3,900 pF | 392 | J | K | M | HE | HE | HE | HE | HE | HG | | JE | JE | JE | JE | JE | JK | KE | KE | KE | KE | KE | KF | KE | 4,700 pF | 472 | J | K | M | HE | HE | HE | HE | HE | HG | | JE | JE | JE | JE | JK | JE | KE | KE | KE | KE | KE | KF | KE | 5,600 pF | 562 | J | K | M | HE | HE | HE | HE | HE | HG | | JE | JE | JE | JE | JK | JE | KE | KE | KE | KE | KE | KF | KE | 6,800 pF | 682 | J | K | M | HE | HE | HE | HE | HE | HJ | | JE | JE | JE | JE | JK | JE | KE | KE | KE | KE | KF | KE | KE | 8,200 pF | 822 | J | K | M | HE | HE | HE | HE | HE | HJ | | JE | JE | JE | JE | JK | JK | KE | KE | KE | KE | KF | KF | KF | 10,000 pF | 103 | J | K | M | HE | HE | HE | HE | HJ | HK | | JE | JE | JE | JE | JL | JL | KE | KE | KE | KE | KF | KH | KH | 12,000 pF | 123 | J | K | M | HE | HE | HE | HG | HJ | | | JE | JK | JK | JK | JL | JL | KE | KE | KE | KE | KF | KH | KH | 15,000 pF | 153 | J | K | M | HE | HE | HE | HG | HK | | | JE | JK | JK | JK | JN | JN | KE | KE | KE | KE | KF | KJ | KJ | 18,000 pF | 183 | J | K | M | HE | HE | HE | HG | | | | JE | JK | JK | JK | JN | | KE | KE | KE | KE | KH | | | 22,000 pF | 223 | J | K | M | HE | HG | HG | HG | | | | JE | JK | JK | JK | JN | | KE | KF | KF | KF | KJ | | | 27,000 pF | 273 | J | K | M | HE | HG | HG | HG | | | | JE | JK | JK | JK | | | KE | KF | KF | KF | KJ | | | 33,000 pF | 333 | J | K | M | HE | HG | HG | HE | | | | JE | JK | JK | JK | | | KE | KF | KF | KF | | | | 39,000 pF | 393 | J | K | M | HE | HG | HG | HG | | | | JE | JK | JK | JE | | | KE | KF | KF | KF | | | | 47,000 pF | 473 | J | K | M | HE | HG | HG | HJ | | | | JE | JK | JK | JK | | | KE | KF | KF | KF | | | | 56,000 pF | 563 | J | K | M | HE | HG | HG | HJ | | | | JE | JE | JE | JL | | | KE | KF | KF | KF | | | | 62,000 pF | 623 | J | K | M | HG | HG | HG | HK | | | | JE | JE | JE | JL | | | KF | KF | KF | KH | | | | 68,000 pF | 683 | J | K | M | HG | HJ | HJ | HK | | | | JE | JK | JK | JL | | | KE | KF | KF | KJ | | | | 82,000 pF | 823 | J | K | M | HG | HJ | HJ | | | | | JE | JL | JL | JN | | | KE | KF | KF | KJ | | | | 0.10 µF | 104 | J | K | M | HG | HK | HK | | | | | JE | JN | JN | | | | KE | KH | KH | KJ | | | | 0.12 µF | 124 | J | K | M | HG | | | | | | | JE | JN | JN | | | | KE | KH | KH | KJ | | | | 0.15 µF | 154 | J | K | M | HG | | | | | | | JK | | | | | | KF | KJ | KJ | | | | | 0.18 µF | 184 | J | K | M | HG | | | | | | | JK | | | | | | KF | | | | | | | 0.22 µF | 224 | J | K | M | HG | | | | | | | | | | | | | KF | | | | | | | | | | | | | | | | | | | | | | | | | | | | | | | | | | | | | | | | | | | | | | | | | | | | | | | | |
| 820 pF | 821 | J | K | M | HG | HG | HG | HG | HG | HG | HG | JK | JK | JK | JK | JK | JK | KF | KF | KF | KF | KF | KF | KF | 1,000 pF | 102 | J | K | M | HG | HG | HG | HG | HG | HG | HG | JK | JK | JK | JK | JK | JK | KF | KF | KF | KF | KF | KF | KF | 1,200 pF | 122 | J | K | M | HG | HG | HG | HG | HG | HG | HG | JK | JK | JK | JK | JK | JK | KF | KF | KF | KF | KF | KF | KF | 1,500 pF | 152 | J | K | M | HG | HG | HG | HG | HG | HG | HG | JK | JK | JK | JK | JK | JK | KF | KF | KF | KF | KF | KF | KF | 1,800 pF | 182 | J | K | M | HE | HE | HE | HE | HE | HG | HG | JK | JK | JK | JK | JK | JK | KF | KF | KF | KF | KF | KF | KF | 2,000 pF | 202 | J | K | M | HE | HE | HE | HE | HE | HG | HG | JE | JE | JE | JE | JE | JK | KF | KF | KF | KF | KF | KF | KF | 2,200 pF | 222 | J | K | M | HE | HE | HE | HE | HE | HG | HG | JE | JE | JE | JE | JE | JK | KF | KF | KF | KF | KF | KF | KF | 2,700 pF | 272 | J | K | M | HE | HE | HE | HE | HE | HG | HG | JE | JE | JE | JE | JE | JK | KE | KE | KE | KE | KE | KF | KE | 3,300 pF | 332 | J | K | M | HE | HE | HE | HE | HE | HG | HG | JE | JE | JE | JE | JE | JK | KE | KE | KE | KE | KE | KF | KE | 3,900 pF | 392 | J | K | M | HE | HE | HE | HE | HE | HG | | JE | JE | JE | JE | JE | JK | KE | KE | KE | KE | KE | KF | KE | 4,700 pF | 472 | J | K | M | HE | HE | HE | HE | HE | HG | | JE | JE | JE | JE | JK | JE | KE | KE | KE | KE | KE | KF | KE | 5,600 pF | 562 | J | K | M | HE | HE | HE | HE | HE | HG | | JE | JE | JE | JE | JK | JE | KE | KE | KE | KE | KE | KF | KE | 6,800 pF | 682 | J | K | M | HE | HE | HE | HE | HE | HJ | | JE | JE | JE | JE | JK | JE | KE | KE | KE | KE | KF | KE | KE | 8,200 pF | 822 | J | K | M | HE | HE | HE | HE | HE | HJ | | JE | JE | JE | JE | JK | JK | KE | KE | KE | KE | KF | KF | KF | 10,000 pF | 103 | J | K | M | HE | HE | HE | HE | HJ | HK | | JE | JE | JE | JE | JL | JL | KE | KE | KE | KE | KF | KH | KH | 12,000 pF | 123 | J | K | M | HE | HE | HE | HG | HJ | | | JE | JK | JK | JK | JL | JL | KE | KE | KE | KE | KF | KH | KH | 15,000 pF | 153 | J | K | M | HE | HE | HE | HG | HK | | | JE | JK | JK | JK | JN | JN | KE | KE | KE | KE | KF | KJ | KJ | 18,000 pF | 183 | J | K | M | HE | HE | HE | HG | | | | JE | JK | JK | JK | JN | | KE | KE | KE | KE | KH | | | 22,000 pF | 223 | J | K | M | HE | HG | HG | HG | | | | JE | JK | JK | JK | JN | | KE | KF | KF | KF | KJ | | | 27,000 pF | 273 | J | K | M | HE | HG | HG | HG | | | | JE | JK | JK | JK | | | KE | KF | KF | KF | KJ | | | 33,000 pF | 333 | J | K | M | HE | HG | HG | HE | | | | JE | JK | JK | JK | | | KE | KF | KF | KF | | | | 39,000 pF | 393 | J | K | M | HE | HG | HG | HG | | | | JE | JK | JK | JE | | | KE | KF | KF | KF | | | | 47,000 pF | 473 | J | K | M | HE | HG | HG | HJ | | | | JE | JK | JK | JK | | | KE | KF | KF | KF | | | | 56,000 pF | 563 | J | K | M | HE | HG | HG | HJ | | | | JE | JE | JE | JL | | | KE | KF | KF | KF | | | | 62,000 pF | 623 | J | K | M | HG | HG | HG | HK | | | | JE | JE | JE | JL | | | KF | KF | KF | KH | | | | 68,000 pF | 683 | J | K | M | HG | HJ | HJ | HK | | | | JE | JK | JK | JL | | | KE | KF | KF | KJ | | | | 82,000 pF | 823 | J | K | M | HG | HJ | HJ | | | | | JE | JL | JL | JN | | | KE | KF | KF | KJ | | | | 0.10 µF | 104 | J | K | M | HG | HK | HK | | | | | JE | JN | JN | | | | KE | KH | KH | KJ | | | | 0.12 µF | 124 | J | K | M | HG | | | | | | | JE | JN | JN | | | | KE | KH | KH | KJ | | | | 0.15 µF | 154 | J | K | M | HG | | | | | | | JK | | | | | | KF | KJ | KJ | | | | | 0.18 µF | 184 | J | K | M | HG | | | | | | | JK | | | | | | KF | | | | | | | 0.22 µF | 224 | J | K | M | HG | | | | | | | | | | | | | KF | | | | | | | | | | | | | | | | | | | | | | | | | | | | | | | | | | | | | | | | | | | | | | | | | | | | | | | | | | | | | | | | | | | | | | | | | | | | | | | | | |
| 1,000 pF | 102 | J | K | M | HG | HG | HG | HG | HG | HG | HG | JK | JK | JK | JK | JK | JK | KF | KF | KF | KF | KF | KF | KF | 1,200 pF | 122 | J | K | M | HG | HG | HG | HG | HG | HG | HG | JK | JK | JK | JK | JK | JK | KF | KF | KF | KF | KF | KF | KF | 1,500 pF | 152 | J | K | M | HG | HG | HG | HG | HG | HG | HG | JK | JK | JK | JK | JK | JK | KF | KF | KF | KF | KF | KF | KF | 1,800 pF | 182 | J | K | M | HE | HE | HE | HE | HE | HG | HG | JK | JK | JK | JK | JK | JK | KF | KF | KF | KF | KF | KF | KF | 2,000 pF | 202 | J | K | M | HE | HE | HE | HE | HE | HG | HG | JE | JE | JE | JE | JE | JK | KF | KF | KF | KF | KF | KF | KF | 2,200 pF | 222 | J | K | M | HE | HE | HE | HE | HE | HG | HG | JE | JE | JE | JE | JE | JK | KF | KF | KF | KF | KF | KF | KF | 2,700 pF | 272 | J | K | M | HE | HE | HE | HE | HE | HG | HG | JE | JE | JE | JE | JE | JK | KE | KE | KE | KE | KE | KF | KE | 3,300 pF | 332 | J | K | M | HE | HE | HE | HE | HE | HG | HG | JE | JE | JE | JE | JE | JK | KE | KE | KE | KE | KE | KF | KE | 3,900 pF | 392 | J | K | M | HE | HE | HE | HE | HE | HG | | JE | JE | JE | JE | JE | JK | KE | KE | KE | KE | KE | KF | KE | 4,700 pF | 472 | J | K | M | HE | HE | HE | HE | HE | HG | | JE | JE | JE | JE | JK | JE | KE | KE | KE | KE | KE | KF | KE | 5,600 pF | 562 | J | K | M | HE | HE | HE | HE | HE | HG | | JE | JE | JE | JE | JK | JE | KE | KE | KE | KE | KE | KF | KE | 6,800 pF | 682 | J | K | M | HE | HE | HE | HE | HE | HJ | | JE | JE | JE | JE | JK | JE | KE | KE | KE | KE | KF | KE | KE | 8,200 pF | 822 | J | K | M | HE | HE | HE | HE | HE | HJ | | JE | JE | JE | JE | JK | JK | KE | KE | KE | KE | KF | KF | KF | 10,000 pF | 103 | J | K | M | HE | HE | HE | HE | HJ | HK | | JE | JE | JE | JE | JL | JL | KE | KE | KE | KE | KF | KH | KH | 12,000 pF | 123 | J | K | M | HE | HE | HE | HG | HJ | | | JE | JK | JK | JK | JL | JL | KE | KE | KE | KE | KF | KH | KH | 15,000 pF | 153 | J | K | M | HE | HE | HE | HG | HK | | | JE | JK | JK | JK | JN | JN | KE | KE | KE | KE | KF | KJ | KJ | 18,000 pF | 183 | J | K | M | HE | HE | HE | HG | | | | JE | JK | JK | JK | JN | | KE | KE | KE | KE | KH | | | 22,000 pF | 223 | J | K | M | HE | HG | HG | HG | | | | JE | JK | JK | JK | JN | | KE | KF | KF | KF | KJ | | | 27,000 pF | 273 | J | K | M | HE | HG | HG | HG | | | | JE | JK | JK | JK | | | KE | KF | KF | KF | KJ | | | 33,000 pF | 333 | J | K | M | HE | HG | HG | HE | | | | JE | JK | JK | JK | | | KE | KF | KF | KF | | | | 39,000 pF | 393 | J | K | M | HE | HG | HG | HG | | | | JE | JK | JK | JE | | | KE | KF | KF | KF | | | | 47,000 pF | 473 | J | K | M | HE | HG | HG | HJ | | | | JE | JK | JK | JK | | | KE | KF | KF | KF | | | | 56,000 pF | 563 | J | K | M | HE | HG | HG | HJ | | | | JE | JE | JE | JL | | | KE | KF | KF | KF | | | | 62,000 pF | 623 | J | K | M | HG | HG | HG | HK | | | | JE | JE | JE | JL | | | KF | KF | KF | KH | | | | 68,000 pF | 683 | J | K | M | HG | HJ | HJ | HK | | | | JE | JK | JK | JL | | | KE | KF | KF | KJ | | | | 82,000 pF | 823 | J | K | M | HG | HJ | HJ | | | | | JE | JL | JL | JN | | | KE | KF | KF | KJ | | | | 0.10 µF | 104 | J | K | M | HG | HK | HK | | | | | JE | JN | JN | | | | KE | KH | KH | KJ | | | | 0.12 µF | 124 | J | K | M | HG | | | | | | | JE | JN | JN | | | | KE | KH | KH | KJ | | | | 0.15 µF | 154 | J | K | M | HG | | | | | | | JK | | | | | | KF | KJ | KJ | | | | | 0.18 µF | 184 | J | K | M | HG | | | | | | | JK | | | | | | KF | | | | | | | 0.22 µF | 224 | J | K | M | HG | | | | | | | | | | | | | KF | | | | | | | | | | | | | | | | | | | | | | | | | | | | | | | | | | | | | | | | | | | | | | | | | | | | | | | | | | | | | | | | | | | | | | | | | | | | | | | | | | | | | | | | | | | | | | | | | | | | | | | | | | |
| 1,200 pF | 122 | J | K | M | HG | HG | HG | HG | HG | HG | HG | JK | JK | JK | JK | JK | JK | KF | KF | KF | KF | KF | KF | KF | 1,500 pF | 152 | J | K | M | HG | HG | HG | HG | HG | HG | HG | JK | JK | JK | JK | JK | JK | KF | KF | KF | KF | KF | KF | KF | 1,800 pF | 182 | J | K | M | HE | HE | HE | HE | HE | HG | HG | JK | JK | JK | JK | JK | JK | KF | KF | KF | KF | KF | KF | KF | 2,000 pF | 202 | J | K | M | HE | HE | HE | HE | HE | HG | HG | JE | JE | JE | JE | JE | JK | KF | KF | KF | KF | KF | KF | KF | 2,200 pF | 222 | J | K | M | HE | HE | HE | HE | HE | HG | HG | JE | JE | JE | JE | JE | JK | KF | KF | KF | KF | KF | KF | KF | 2,700 pF | 272 | J | K | M | HE | HE | HE | HE | HE | HG | HG | JE | JE | JE | JE | JE | JK | KE | KE | KE | KE | KE | KF | KE | 3,300 pF | 332 | J | K | M | HE | HE | HE | HE | HE | HG | HG | JE | JE | JE | JE | JE | JK | KE | KE | KE | KE | KE | KF | KE | 3,900 pF | 392 | J | K | M | HE | HE | HE | HE | HE | HG | | JE | JE | JE | JE | JE | JK | KE | KE | KE | KE | KE | KF | KE | 4,700 pF | 472 | J | K | M | HE | HE | HE | HE | HE | HG | | JE | JE | JE | JE | JK | JE | KE | KE | KE | KE | KE | KF | KE | 5,600 pF | 562 | J | K | M | HE | HE | HE | HE | HE | HG | | JE | JE | JE | JE | JK | JE | KE | KE | KE | KE | KE | KF | KE | 6,800 pF | 682 | J | K | M | HE | HE | HE | HE | HE | HJ | | JE | JE | JE | JE | JK | JE | KE | KE | KE | KE | KF | KE | KE | 8,200 pF | 822 | J | K | M | HE | HE | HE | HE | HE | HJ | | JE | JE | JE | JE | JK | JK | KE | KE | KE | KE | KF | KF | KF | 10,000 pF | 103 | J | K | M | HE | HE | HE | HE | HJ | HK | | JE | JE | JE | JE | JL | JL | KE | KE | KE | KE | KF | KH | KH | 12,000 pF | 123 | J | K | M | HE | HE | HE | HG | HJ | | | JE | JK | JK | JK | JL | JL | KE | KE | KE | KE | KF | KH | KH | 15,000 pF | 153 | J | K | M | HE | HE | HE | HG | HK | | | JE | JK | JK | JK | JN | JN | KE | KE | KE | KE | KF | KJ | KJ | 18,000 pF | 183 | J | K | M | HE | HE | HE | HG | | | | JE | JK | JK | JK | JN | | KE | KE | KE | KE | KH | | | 22,000 pF | 223 | J | K | M | HE | HG | HG | HG | | | | JE | JK | JK | JK | JN | | KE | KF | KF | KF | KJ | | | 27,000 pF | 273 | J | K | M | HE | HG | HG | HG | | | | JE | JK | JK | JK | | | KE | KF | KF | KF | KJ | | | 33,000 pF | 333 | J | K | M | HE | HG | HG | HE | | | | JE | JK | JK | JK | | | KE | KF | KF | KF | | | | 39,000 pF | 393 | J | K | M | HE | HG | HG | HG | | | | JE | JK | JK | JE | | | KE | KF | KF | KF | | | | 47,000 pF | 473 | J | K | M | HE | HG | HG | HJ | | | | JE | JK | JK | JK | | | KE | KF | KF | KF | | | | 56,000 pF | 563 | J | K | M | HE | HG | HG | HJ | | | | JE | JE | JE | JL | | | KE | KF | KF | KF | | | | 62,000 pF | 623 | J | K | M | HG | HG | HG | HK | | | | JE | JE | JE | JL | | | KF | KF | KF | KH | | | | 68,000 pF | 683 | J | K | M | HG | HJ | HJ | HK | | | | JE | JK | JK | JL | | | KE | KF | KF | KJ | | | | 82,000 pF | 823 | J | K | M | HG | HJ | HJ | | | | | JE | JL | JL | JN | | | KE | KF | KF | KJ | | | | 0.10 µF | 104 | J | K | M | HG | HK | HK | | | | | JE | JN | JN | | | | KE | KH | KH | KJ | | | | 0.12 µF | 124 | J | K | M | HG | | | | | | | JE | JN | JN | | | | KE | KH | KH | KJ | | | | 0.15 µF | 154 | J | K | M | HG | | | | | | | JK | | | | | | KF | KJ | KJ | | | | | 0.18 µF | 184 | J | K | M | HG | | | | | | | JK | | | | | | KF | | | | | | | 0.22 µF | 224 | J | K | M | HG | | | | | | | | | | | | | KF | | | | | | | | | | | | | | | | | | | | | | | | | | | | | | | | | | | | | | | | | | | | | | | | | | | | | | | | | | | | | | | | | | | | | | | | | | | | | | | | | | | | | | | | | | | | | | | | | | | | | | | | | | | | | | | | | | | | | | | | | | | | | | | | | | | |
| 1,500 pF | 152 | J | K | M | HG | HG | HG | HG | HG | HG | HG | JK | JK | JK | JK | JK | JK | KF | KF | KF | KF | KF | KF | KF | 1,800 pF | 182 | J | K | M | HE | HE | HE | HE | HE | HG | HG | JK | JK | JK | JK | JK | JK | KF | KF | KF | KF | KF | KF | KF | 2,000 pF | 202 | J | K | M | HE | HE | HE | HE | HE | HG | HG | JE | JE | JE | JE | JE | JK | KF | KF | KF | KF | KF | KF | KF | 2,200 pF | 222 | J | K | M | HE | HE | HE | HE | HE | HG | HG | JE | JE | JE | JE | JE | JK | KF | KF | KF | KF | KF | KF | KF | 2,700 pF | 272 | J | K | M | HE | HE | HE | HE | HE | HG | HG | JE | JE | JE | JE | JE | JK | KE | KE | KE | KE | KE | KF | KE | 3,300 pF | 332 | J | K | M | HE | HE | HE | HE | HE | HG | HG | JE | JE | JE | JE | JE | JK | KE | KE | KE | KE | KE | KF | KE | 3,900 pF | 392 | J | K | M | HE | HE | HE | HE | HE | HG | | JE | JE | JE | JE | JE | JK | KE | KE | KE | KE | KE | KF | KE | 4,700 pF | 472 | J | K | M | HE | HE | HE | HE | HE | HG | | JE | JE | JE | JE | JK | JE | KE | KE | KE | KE | KE | KF | KE | 5,600 pF | 562 | J | K | M | HE | HE | HE | HE | HE | HG | | JE | JE | JE | JE | JK | JE | KE | KE | KE | KE | KE | KF | KE | 6,800 pF | 682 | J | K | M | HE | HE | HE | HE | HE | HJ | | JE | JE | JE | JE | JK | JE | KE | KE | KE | KE | KF | KE | KE | 8,200 pF | 822 | J | K | M | HE | HE | HE | HE | HE | HJ | | JE | JE | JE | JE | JK | JK | KE | KE | KE | KE | KF | KF | KF | 10,000 pF | 103 | J | K | M | HE | HE | HE | HE | HJ | HK | | JE | JE | JE | JE | JL | JL | KE | KE | KE | KE | KF | KH | KH | 12,000 pF | 123 | J | K | M | HE | HE | HE | HG | HJ | | | JE | JK | JK | JK | JL | JL | KE | KE | KE | KE | KF | KH | KH | 15,000 pF | 153 | J | K | M | HE | HE | HE | HG | HK | | | JE | JK | JK | JK | JN | JN | KE | KE | KE | KE | KF | KJ | KJ | 18,000 pF | 183 | J | K | M | HE | HE | HE | HG | | | | JE | JK | JK | JK | JN | | KE | KE | KE | KE | KH | | | 22,000 pF | 223 | J | K | M | HE | HG | HG | HG | | | | JE | JK | JK | JK | JN | | KE | KF | KF | KF | KJ | | | 27,000 pF | 273 | J | K | M | HE | HG | HG | HG | | | | JE | JK | JK | JK | | | KE | KF | KF | KF | KJ | | | 33,000 pF | 333 | J | K | M | HE | HG | HG | HE | | | | JE | JK | JK | JK | | | KE | KF | KF | KF | | | | 39,000 pF | 393 | J | K | M | HE | HG | HG | HG | | | | JE | JK | JK | JE | | | KE | KF | KF | KF | | | | 47,000 pF | 473 | J | K | M | HE | HG | HG | HJ | | | | JE | JK | JK | JK | | | KE | KF | KF | KF | | | | 56,000 pF | 563 | J | K | M | HE | HG | HG | HJ | | | | JE | JE | JE | JL | | | KE | KF | KF | KF | | | | 62,000 pF | 623 | J | K | M | HG | HG | HG | HK | | | | JE | JE | JE | JL | | | KF | KF | KF | KH | | | | 68,000 pF | 683 | J | K | M | HG | HJ | HJ | HK | | | | JE | JK | JK | JL | | | KE | KF | KF | KJ | | | | 82,000 pF | 823 | J | K | M | HG | HJ | HJ | | | | | JE | JL | JL | JN | | | KE | KF | KF | KJ | | | | 0.10 µF | 104 | J | K | M | HG | HK | HK | | | | | JE | JN | JN | | | | KE | KH | KH | KJ | | | | 0.12 µF | 124 | J | K | M | HG | | | | | | | JE | JN | JN | | | | KE | KH | KH | KJ | | | | 0.15 µF | 154 | J | K | M | HG | | | | | | | JK | | | | | | KF | KJ | KJ | | | | | 0.18 µF | 184 | J | K | M | HG | | | | | | | JK | | | | | | KF | | | | | | | 0.22 µF | 224 | J | K | M | HG | | | | | | | | | | | | | KF | | | | | | | | | | | | | | | | | | | | | | | | | | | | | | | | | | | | | | | | | | | | | | | | | | | | | | | | | | | | | | | | | | | | | | | | | | | | | | | | | | | | | | | | | | | | | | | | | | | | | | | | | | | | | | | | | | | | | | | | | | | | | | | | | | | | | | | | | | | | | | | | | | | | | | | | | | | | |
| 1,800 pF | 182 | J | K | M | HE | HE | HE | HE | HE | HG | HG | JK | JK | JK | JK | JK | JK | KF | KF | KF | KF | KF | KF | KF | 2,000 pF | 202 | J | K | M | HE | HE | HE | HE | HE | HG | HG | JE | JE | JE | JE | JE | JK | KF | KF | KF | KF | KF | KF | KF | 2,200 pF | 222 | J | K | M | HE | HE | HE | HE | HE | HG | HG | JE | JE | JE | JE | JE | JK | KF | KF | KF | KF | KF | KF | KF | 2,700 pF | 272 | J | K | M | HE | HE | HE | HE | HE | HG | HG | JE | JE | JE | JE | JE | JK | KE | KE | KE | KE | KE | KF | KE | 3,300 pF | 332 | J | K | M | HE | HE | HE | HE | HE | HG | HG | JE | JE | JE | JE | JE | JK | KE | KE | KE | KE | KE | KF | KE | 3,900 pF | 392 | J | K | M | HE | HE | HE | HE | HE | HG | | JE | JE | JE | JE | JE | JK | KE | KE | KE | KE | KE | KF | KE | 4,700 pF | 472 | J | K | M | HE | HE | HE | HE | HE | HG | | JE | JE | JE | JE | JK | JE | KE | KE | KE | KE | KE | KF | KE | 5,600 pF | 562 | J | K | M | HE | HE | HE | HE | HE | HG | | JE | JE | JE | JE | JK | JE | KE | KE | KE | KE | KE | KF | KE | 6,800 pF | 682 | J | K | M | HE | HE | HE | HE | HE | HJ | | JE | JE | JE | JE | JK | JE | KE | KE | KE | KE | KF | KE | KE | 8,200 pF | 822 | J | K | M | HE | HE | HE | HE | HE | HJ | | JE | JE | JE | JE | JK | JK | KE | KE | KE | KE | KF | KF | KF | 10,000 pF | 103 | J | K | M | HE | HE | HE | HE | HJ | HK | | JE | JE | JE | JE | JL | JL | KE | KE | KE | KE | KF | KH | KH | 12,000 pF | 123 | J | K | M | HE | HE | HE | HG | HJ | | | JE | JK | JK | JK | JL | JL | KE | KE | KE | KE | KF | KH | KH | 15,000 pF | 153 | J | K | M | HE | HE | HE | HG | HK | | | JE | JK | JK | JK | JN | JN | KE | KE | KE | KE | KF | KJ | KJ | 18,000 pF | 183 | J | K | M | HE | HE | HE | HG | | | | JE | JK | JK | JK | JN | | KE | KE | KE | KE | KH | | | 22,000 pF | 223 | J | K | M | HE | HG | HG | HG | | | | JE | JK | JK | JK | JN | | KE | KF | KF | KF | KJ | | | 27,000 pF | 273 | J | K | M | HE | HG | HG | HG | | | | JE | JK | JK | JK | | | KE | KF | KF | KF | KJ | | | 33,000 pF | 333 | J | K | M | HE | HG | HG | HE | | | | JE | JK | JK | JK | | | KE | KF | KF | KF | | | | 39,000 pF | 393 | J | K | M | HE | HG | HG | HG | | | | JE | JK | JK | JE | | | KE | KF | KF | KF | | | | 47,000 pF | 473 | J | K | M | HE | HG | HG | HJ | | | | JE | JK | JK | JK | | | KE | KF | KF | KF | | | | 56,000 pF | 563 | J | K | M | HE | HG | HG | HJ | | | | JE | JE | JE | JL | | | KE | KF | KF | KF | | | | 62,000 pF | 623 | J | K | M | HG | HG | HG | HK | | | | JE | JE | JE | JL | | | KF | KF | KF | KH | | | | 68,000 pF | 683 | J | K | M | HG | HJ | HJ | HK | | | | JE | JK | JK | JL | | | KE | KF | KF | KJ | | | | 82,000 pF | 823 | J | K | M | HG | HJ | HJ | | | | | JE | JL | JL | JN | | | KE | KF | KF | KJ | | | | 0.10 µF | 104 | J | K | M | HG | HK | HK | | | | | JE | JN | JN | | | | KE | KH | KH | KJ | | | | 0.12 µF | 124 | J | K | M | HG | | | | | | | JE | JN | JN | | | | KE | KH | KH | KJ | | | | 0.15 µF | 154 | J | K | M | HG | | | | | | | JK | | | | | | KF | KJ | KJ | | | | | 0.18 µF | 184 | J | K | M | HG | | | | | | | JK | | | | | | KF | | | | | | | 0.22 µF | 224 | J | K | M | HG | | | | | | | | | | | | | KF | | | | | | | | | | | | | | | | | | | | | | | | | | | | | | | | | | | | | | | | | | | | | | | | | | | | | | | | | | | | | | | | | | | | | | | | | | | | | | | | | | | | | | | | | | | | | | | | | | | | | | | | | | | | | | | | | | | | | | | | | | | | | | | | | | | | | | | | | | | | | | | | | | | | | | | | | | | | | | | | | | | | | | | | | | | | | | | | | | | | | |
| 2,000 pF | 202 | J | K | M | HE | HE | HE | HE | HE | HG | HG | JE | JE | JE | JE | JE | JK | KF | KF | KF | KF | KF | KF | KF | 2,200 pF | 222 | J | K | M | HE | HE | HE | HE | HE | HG | HG | JE | JE | JE | JE | JE | JK | KF | KF | KF | KF | KF | KF | KF | 2,700 pF | 272 | J | K | M | HE | HE | HE | HE | HE | HG | HG | JE | JE | JE | JE | JE | JK | KE | KE | KE | KE | KE | KF | KE | 3,300 pF | 332 | J | K | M | HE | HE | HE | HE | HE | HG | HG | JE | JE | JE | JE | JE | JK | KE | KE | KE | KE | KE | KF | KE | 3,900 pF | 392 | J | K | M | HE | HE | HE | HE | HE | HG | | JE | JE | JE | JE | JE | JK | KE | KE | KE | KE | KE | KF | KE | 4,700 pF | 472 | J | K | M | HE | HE | HE | HE | HE | HG | | JE | JE | JE | JE | JK | JE | KE | KE | KE | KE | KE | KF | KE | 5,600 pF | 562 | J | K | M | HE | HE | HE | HE | HE | HG | | JE | JE | JE | JE | JK | JE | KE | KE | KE | KE | KE | KF | KE | 6,800 pF | 682 | J | K | M | HE | HE | HE | HE | HE | HJ | | JE | JE | JE | JE | JK | JE | KE | KE | KE | KE | KF | KE | KE | 8,200 pF | 822 | J | K | M | HE | HE | HE | HE | HE | HJ | | JE | JE | JE | JE | JK | JK | KE | KE | KE | KE | KF | KF | KF | 10,000 pF | 103 | J | K | M | HE | HE | HE | HE | HJ | HK | | JE | JE | JE | JE | JL | JL | KE | KE | KE | KE | KF | KH | KH | 12,000 pF | 123 | J | K | M | HE | HE | HE | HG | HJ | | | JE | JK | JK | JK | JL | JL | KE | KE | KE | KE | KF | KH | KH | 15,000 pF | 153 | J | K | M | HE | HE | HE | HG | HK | | | JE | JK | JK | JK | JN | JN | KE | KE | KE | KE | KF | KJ | KJ | 18,000 pF | 183 | J | K | M | HE | HE | HE | HG | | | | JE | JK | JK | JK | JN | | KE | KE | KE | KE | KH | | | 22,000 pF | 223 | J | K | M | HE | HG | HG | HG | | | | JE | JK | JK | JK | JN | | KE | KF | KF | KF | KJ | | | 27,000 pF | 273 | J | K | M | HE | HG | HG | HG | | | | JE | JK | JK | JK | | | KE | KF | KF | KF | KJ | | | 33,000 pF | 333 | J | K | M | HE | HG | HG | HE | | | | JE | JK | JK | JK | | | KE | KF | KF | KF | | | | 39,000 pF | 393 | J | K | M | HE | HG | HG | HG | | | | JE | JK | JK | JE | | | KE | KF | KF | KF | | | | 47,000 pF | 473 | J | K | M | HE | HG | HG | HJ | | | | JE | JK | JK | JK | | | KE | KF | KF | KF | | | | 56,000 pF | 563 | J | K | M | HE | HG | HG | HJ | | | | JE | JE | JE | JL | | | KE | KF | KF | KF | | | | 62,000 pF | 623 | J | K | M | HG | HG | HG | HK | | | | JE | JE | JE | JL | | | KF | KF | KF | KH | | | | 68,000 pF | 683 | J | K | M | HG | HJ | HJ | HK | | | | JE | JK | JK | JL | | | KE | KF | KF | KJ | | | | 82,000 pF | 823 | J | K | M | HG | HJ | HJ | | | | | JE | JL | JL | JN | | | KE | KF | KF | KJ | | | | 0.10 µF | 104 | J | K | M | HG | HK | HK | | | | | JE | JN | JN | | | | KE | KH | KH | KJ | | | | 0.12 µF | 124 | J | K | M | HG | | | | | | | JE | JN | JN | | | | KE | KH | KH | KJ | | | | 0.15 µF | 154 | J | K | M | HG | | | | | | | JK | | | | | | KF | KJ | KJ | | | | | 0.18 µF | 184 | J | K | M | HG | | | | | | | JK | | | | | | KF | | | | | | | 0.22 µF | 224 | J | K | M | HG | | | | | | | | | | | | | KF | | | | | | | | | | | | | | | | | | | | | | | | | | | | | | | | | | | | | | | | | | | | | | | | | | | | | | | | | | | | | | | | | | | | | | | | | | | | | | | | | | | | | | | | | | | | | | | | | | | | | | | | | | | | | | | | | | | | | | | | | | | | | | | | | | | | | | | | | | | | | | | | | | | | | | | | | | | | | | | | | | | | | | | | | | | | | | | | | | | | | | | | | | | | | | | | | | | | | | | | | | | | | | |
| 2,200 pF | 222 | J | K | M | HE | HE | HE | HE | HE | HG | HG | JE | JE | JE | JE | JE | JK | KF | KF | KF | KF | KF | KF | KF | 2,700 pF | 272 | J | K | M | HE | HE | HE | HE | HE | HG | HG | JE | JE | JE | JE | JE | JK | KE | KE | KE | KE | KE | KF | KE | 3,300 pF | 332 | J | K | M | HE | HE | HE | HE | HE | HG | HG | JE | JE | JE | JE | JE | JK | KE | KE | KE | KE | KE | KF | KE | 3,900 pF | 392 | J | K | M | HE | HE | HE | HE | HE | HG | | JE | JE | JE | JE | JE | JK | KE | KE | KE | KE | KE | KF | KE | 4,700 pF | 472 | J | K | M | HE | HE | HE | HE | HE | HG | | JE | JE | JE | JE | JK | JE | KE | KE | KE | KE | KE | KF | KE | 5,600 pF | 562 | J | K | M | HE | HE | HE | HE | HE | HG | | JE | JE | JE | JE | JK | JE | KE | KE | KE | KE | KE | KF | KE | 6,800 pF | 682 | J | K | M | HE | HE | HE | HE | HE | HJ | | JE | JE | JE | JE | JK | JE | KE | KE | KE | KE | KF | KE | KE | 8,200 pF | 822 | J | K | M | HE | HE | HE | HE | HE | HJ | | JE | JE | JE | JE | JK | JK | KE | KE | KE | KE | KF | KF | KF | 10,000 pF | 103 | J | K | M | HE | HE | HE | HE | HJ | HK | | JE | JE | JE | JE | JL | JL | KE | KE | KE | KE | KF | KH | KH | 12,000 pF | 123 | J | K | M | HE | HE | HE | HG | HJ | | | JE | JK | JK | JK | JL | JL | KE | KE | KE | KE | KF | KH | KH | 15,000 pF | 153 | J | K | M | HE | HE | HE | HG | HK | | | JE | JK | JK | JK | JN | JN | KE | KE | KE | KE | KF | KJ | KJ | 18,000 pF | 183 | J | K | M | HE | HE | HE | HG | | | | JE | JK | JK | JK | JN | | KE | KE | KE | KE | KH | | | 22,000 pF | 223 | J | K | M | HE | HG | HG | HG | | | | JE | JK | JK | JK | JN | | KE | KF | KF | KF | KJ | | | 27,000 pF | 273 | J | K | M | HE | HG | HG | HG | | | | JE | JK | JK | JK | | | KE | KF | KF | KF | KJ | | | 33,000 pF | 333 | J | K | M | HE | HG | HG | HE | | | | JE | JK | JK | JK | | | KE | KF | KF | KF | | | | 39,000 pF | 393 | J | K | M | HE | HG | HG | HG | | | | JE | JK | JK | JE | | | KE | KF | KF | KF | | | | 47,000 pF | 473 | J | K | M | HE | HG | HG | HJ | | | | JE | JK | JK | JK | | | KE | KF | KF | KF | | | | 56,000 pF | 563 | J | K | M | HE | HG | HG | HJ | | | | JE | JE | JE | JL | | | KE | KF | KF | KF | | | | 62,000 pF | 623 | J | K | M | HG | HG | HG | HK | | | | JE | JE | JE | JL | | | KF | KF | KF | KH | | | | 68,000 pF | 683 | J | K | M | HG | HJ | HJ | HK | | | | JE | JK | JK | JL | | | KE | KF | KF | KJ | | | | 82,000 pF | 823 | J | K | M | HG | HJ | HJ | | | | | JE | JL | JL | JN | | | KE | KF | KF | KJ | | | | 0.10 µF | 104 | J | K | M | HG | HK | HK | | | | | JE | JN | JN | | | | KE | KH | KH | KJ | | | | 0.12 µF | 124 | J | K | M | HG | | | | | | | JE | JN | JN | | | | KE | KH | KH | KJ | | | | 0.15 µF | 154 | J | K | M | HG | | | | | | | JK | | | | | | KF | KJ | KJ | | | | | 0.18 µF | 184 | J | K | M | HG | | | | | | | JK | | | | | | KF | | | | | | | 0.22 µF | 224 | J | K | M | HG | | | | | | | | | | | | | KF | | | | | | | | | | | | | | | | | | | | | | | | | | | | | | | | | | | | | | | | | | | | | | | | | | | | | | | | | | | | | | | | | | | | | | | | | | | | | | | | | | | | | | | | | | | | | | | | | | | | | | | | | | | | | | | | | | | | | | | | | | | | | | | | | | | | | | | | | | | | | | | | | | | | | | | | | | | | | | | | | | | | | | | | | | | | | | | | | | | | | | | | | | | | | | | | | | | | | | | | | | | | | | | | | | | | | | | | | | | | | | | | | | | | | | | |
| 2,700 pF | 272 | J | K | M | HE | HE | HE | HE | HE | HG | HG | JE | JE | JE | JE | JE | JK | KE | KE | KE | KE | KE | KF | KE | 3,300 pF | 332 | J | K | M | HE | HE | HE | HE | HE | HG | HG | JE | JE | JE | JE | JE | JK | KE | KE | KE | KE | KE | KF | KE | 3,900 pF | 392 | J | K | M | HE | HE | HE | HE | HE | HG | | JE | JE | JE | JE | JE | JK | KE | KE | KE | KE | KE | KF | KE | 4,700 pF | 472 | J | K | M | HE | HE | HE | HE | HE | HG | | JE | JE | JE | JE | JK | JE | KE | KE | KE | KE | KE | KF | KE | 5,600 pF | 562 | J | K | M | HE | HE | HE | HE | HE | HG | | JE | JE | JE | JE | JK | JE | KE | KE | KE | KE | KE | KF | KE | 6,800 pF | 682 | J | K | M | HE | HE | HE | HE | HE | HJ | | JE | JE | JE | JE | JK | JE | KE | KE | KE | KE | KF | KE | KE | 8,200 pF | 822 | J | K | M | HE | HE | HE | HE | HE | HJ | | JE | JE | JE | JE | JK | JK | KE | KE | KE | KE | KF | KF | KF | 10,000 pF | 103 | J | K | M | HE | HE | HE | HE | HJ | HK | | JE | JE | JE | JE | JL | JL | KE | KE | KE | KE | KF | KH | KH | 12,000 pF | 123 | J | K | M | HE | HE | HE | HG | HJ | | | JE | JK | JK | JK | JL | JL | KE | KE | KE | KE | KF | KH | KH | 15,000 pF | 153 | J | K | M | HE | HE | HE | HG | HK | | | JE | JK | JK | JK | JN | JN | KE | KE | KE | KE | KF | KJ | KJ | 18,000 pF | 183 | J | K | M | HE | HE | HE | HG | | | | JE | JK | JK | JK | JN | | KE | KE | KE | KE | KH | | | 22,000 pF | 223 | J | K | M | HE | HG | HG | HG | | | | JE | JK | JK | JK | JN | | KE | KF | KF | KF | KJ | | | 27,000 pF | 273 | J | K | M | HE | HG | HG | HG | | | | JE | JK | JK | JK | | | KE | KF | KF | KF | KJ | | | 33,000 pF | 333 | J | K | M | HE | HG | HG | HE | | | | JE | JK | JK | JK | | | KE | KF | KF | KF | | | | 39,000 pF | 393 | J | K | M | HE | HG | HG | HG | | | | JE | JK | JK | JE | | | KE | KF | KF | KF | | | | 47,000 pF | 473 | J | K | M | HE | HG | HG | HJ | | | | JE | JK | JK | JK | | | KE | KF | KF | KF | | | | 56,000 pF | 563 | J | K | M | HE | HG | HG | HJ | | | | JE | JE | JE | JL | | | KE | KF | KF | KF | | | | 62,000 pF | 623 | J | K | M | HG | HG | HG | HK | | | | JE | JE | JE | JL | | | KF | KF | KF | KH | | | | 68,000 pF | 683 | J | K | M | HG | HJ | HJ | HK | | | | JE | JK | JK | JL | | | KE | KF | KF | KJ | | | | 82,000 pF | 823 | J | K | M | HG | HJ | HJ | | | | | JE | JL | JL | JN | | | KE | KF | KF | KJ | | | | 0.10 µF | 104 | J | K | M | HG | HK | HK | | | | | JE | JN | JN | | | | KE | KH | KH | KJ | | | | 0.12 µF | 124 | J | K | M | HG | | | | | | | JE | JN | JN | | | | KE | KH | KH | KJ | | | | 0.15 µF | 154 | J | K | M | HG | | | | | | | JK | | | | | | KF | KJ | KJ | | | | | 0.18 µF | 184 | J | K | M | HG | | | | | | | JK | | | | | | KF | | | | | | | 0.22 µF | 224 | J | K | M | HG | | | | | | | | | | | | | KF | | | | | | | | | | | | | | | | | | | | | | | | | | | | | | | | | | | | | | | | | | | | | | | | | | | | | | | | | | | | | | | | | | | | | | | | | | | | | | | | | | | | | | | | | | | | | | | | | | | | | | | | | | | | | | | | | | | | | | | | | | | | | | | | | | | | | | | | | | | | | | | | | | | | | | | | | | | | | | | | | | | | | | | | | | | | | | | | | | | | | | | | | | | | | | | | | | | | | | | | | | | | | | | | | | | | | | | | | | | | | | | | | | | | | | | | | | | | | | | | | | | | | | | | | | | | | | | | |
| 3,300 pF | 332 | J | K | M | HE | HE | HE | HE | HE | HG | HG | JE | JE | JE | JE | JE | JK | KE | KE | KE | KE | KE | KF | KE | 3,900 pF | 392 | J | K | M | HE | HE | HE | HE | HE | HG | | JE | JE | JE | JE | JE | JK | KE | KE | KE | KE | KE | KF | KE | 4,700 pF | 472 | J | K | M | HE | HE | HE | HE | HE | HG | | JE | JE | JE | JE | JK | JE | KE | KE | KE | KE | KE | KF | KE | 5,600 pF | 562 | J | K | M | HE | HE | HE | HE | HE | HG | | JE | JE | JE | JE | JK | JE | KE | KE | KE | KE | KE | KF | KE | 6,800 pF | 682 | J | K | M | HE | HE | HE | HE | HE | HJ | | JE | JE | JE | JE | JK | JE | KE | KE | KE | KE | KF | KE | KE | 8,200 pF | 822 | J | K | M | HE | HE | HE | HE | HE | HJ | | JE | JE | JE | JE | JK | JK | KE | KE | KE | KE | KF | KF | KF | 10,000 pF | 103 | J | K | M | HE | HE | HE | HE | HJ | HK | | JE | JE | JE | JE | JL | JL | KE | KE | KE | KE | KF | KH | KH | 12,000 pF | 123 | J | K | M | HE | HE | HE | HG | HJ | | | JE | JK | JK | JK | JL | JL | KE | KE | KE | KE | KF | KH | KH | 15,000 pF | 153 | J | K | M | HE | HE | HE | HG | HK | | | JE | JK | JK | JK | JN | JN | KE | KE | KE | KE | KF | KJ | KJ | 18,000 pF | 183 | J | K | M | HE | HE | HE | HG | | | | JE | JK | JK | JK | JN | | KE | KE | KE | KE | KH | | | 22,000 pF | 223 | J | K | M | HE | HG | HG | HG | | | | JE | JK | JK | JK | JN | | KE | KF | KF | KF | KJ | | | 27,000 pF | 273 | J | K | M | HE | HG | HG | HG | | | | JE | JK | JK | JK | | | KE | KF | KF | KF | KJ | | | 33,000 pF | 333 | J | K | M | HE | HG | HG | HE | | | | JE | JK | JK | JK | | | KE | KF | KF | KF | | | | 39,000 pF | 393 | J | K | M | HE | HG | HG | HG | | | | JE | JK | JK | JE | | | KE | KF | KF | KF | | | | 47,000 pF | 473 | J | K | M | HE | HG | HG | HJ | | | | JE | JK | JK | JK | | | KE | KF | KF | KF | | | | 56,000 pF | 563 | J | K | M | HE | HG | HG | HJ | | | | JE | JE | JE | JL | | | KE | KF | KF | KF | | | | 62,000 pF | 623 | J | K | M | HG | HG | HG | HK | | | | JE | JE | JE | JL | | | KF | KF | KF | KH | | | | 68,000 pF | 683 | J | K | M | HG | HJ | HJ | HK | | | | JE | JK | JK | JL | | | KE | KF | KF | KJ | | | | 82,000 pF | 823 | J | K | M | HG | HJ | HJ | | | | | JE | JL | JL | JN | | | KE | KF | KF | KJ | | | | 0.10 µF | 104 | J | K | M | HG | HK | HK | | | | | JE | JN | JN | | | | KE | KH | KH | KJ | | | | 0.12 µF | 124 | J | K | M | HG | | | | | | | JE | JN | JN | | | | KE | KH | KH | KJ | | | | 0.15 µF | 154 | J | K | M | HG | | | | | | | JK | | | | | | KF | KJ | KJ | | | | | 0.18 µF | 184 | J | K | M | HG | | | | | | | JK | | | | | | KF | | | | | | | 0.22 µF | 224 | J | K | M | HG | | | | | | | | | | | | | KF | | | | | | | | | | | | | | | | | | | | | | | | | | | | | | | | | | | | | | | | | | | | | | | | | | | | | | | | | | | | | | | | | | | | | | | | | | | | | | | | | | | | | | | | | | | | | | | | | | | | | | | | | | | | | | | | | | | | | | | | | | | | | | | | | | | | | | | | | | | | | | | | | | | | | | | | | | | | | | | | | | | | | | | | | | | | | | | | | | | | | | | | | | | | | | | | | | | | | | | | | | | | | | | | | | | | | | | | | | | | | | | | | | | | | | | | | | | | | | | | | | | | | | | | | | | | | | | | | | | | | | | | | | | | | | | | | | | | | | | | | |
| 3,900 pF | 392 | J | K | M | HE | HE | HE | HE | HE | HG | | JE | JE | JE | JE | JE | JK | KE | KE | KE | KE | KE | KF | KE | 4,700 pF | 472 | J | K | M | HE | HE | HE | HE | HE | HG | | JE | JE | JE | JE | JK | JE | KE | KE | KE | KE | KE | KF | KE | 5,600 pF | 562 | J | K | M | HE | HE | HE | HE | HE | HG | | JE | JE | JE | JE | JK | JE | KE | KE | KE | KE | KE | KF | KE | 6,800 pF | 682 | J | K | M | HE | HE | HE | HE | HE | HJ | | JE | JE | JE | JE | JK | JE | KE | KE | KE | KE | KF | KE | KE | 8,200 pF | 822 | J | K | M | HE | HE | HE | HE | HE | HJ | | JE | JE | JE | JE | JK | JK | KE | KE | KE | KE | KF | KF | KF | 10,000 pF | 103 | J | K | M | HE | HE | HE | HE | HJ | HK | | JE | JE | JE | JE | JL | JL | KE | KE | KE | KE | KF | KH | KH | 12,000 pF | 123 | J | K | M | HE | HE | HE | HG | HJ | | | JE | JK | JK | JK | JL | JL | KE | KE | KE | KE | KF | KH | KH | 15,000 pF | 153 | J | K | M | HE | HE | HE | HG | HK | | | JE | JK | JK | JK | JN | JN | KE | KE | KE | KE | KF | KJ | KJ | 18,000 pF | 183 | J | K | M | HE | HE | HE | HG | | | | JE | JK | JK | JK | JN | | KE | KE | KE | KE | KH | | | 22,000 pF | 223 | J | K | M | HE | HG | HG | HG | | | | JE | JK | JK | JK | JN | | KE | KF | KF | KF | KJ | | | 27,000 pF | 273 | J | K | M | HE | HG | HG | HG | | | | JE | JK | JK | JK | | | KE | KF | KF | KF | KJ | | | 33,000 pF | 333 | J | K | M | HE | HG | HG | HE | | | | JE | JK | JK | JK | | | KE | KF | KF | KF | | | | 39,000 pF | 393 | J | K | M | HE | HG | HG | HG | | | | JE | JK | JK | JE | | | KE | KF | KF | KF | | | | 47,000 pF | 473 | J | K | M | HE | HG | HG | HJ | | | | JE | JK | JK | JK | | | KE | KF | KF | KF | | | | 56,000 pF | 563 | J | K | M | HE | HG | HG | HJ | | | | JE | JE | JE | JL | | | KE | KF | KF | KF | | | | 62,000 pF | 623 | J | K | M | HG | HG | HG | HK | | | | JE | JE | JE | JL | | | KF | KF | KF | KH | | | | 68,000 pF | 683 | J | K | M | HG | HJ | HJ | HK | | | | JE | JK | JK | JL | | | KE | KF | KF | KJ | | | | 82,000 pF | 823 | J | K | M | HG | HJ | HJ | | | | | JE | JL | JL | JN | | | KE | KF | KF | KJ | | | | 0.10 µF | 104 | J | K | M | HG | HK | HK | | | | | JE | JN | JN | | | | KE | KH | KH | KJ | | | | 0.12 µF | 124 | J | K | M | HG | | | | | | | JE | JN | JN | | | | KE | KH | KH | KJ | | | | 0.15 µF | 154 | J | K | M | HG | | | | | | | JK | | | | | | KF | KJ | KJ | | | | | 0.18 µF | 184 | J | K | M | HG | | | | | | | JK | | | | | | KF | | | | | | | 0.22 µF | 224 | J | K | M | HG | | | | | | | | | | | | | KF | | | | | | | | | | | | | | | | | | | | | | | | | | | | | | | | | | | | | | | | | | | | | | | | | | | | | | | | | | | | | | | | | | | | | | | | | | | | | | | | | | | | | | | | | | | | | | | | | | | | | | | | | | | | | | | | | | | | | | | | | | | | | | | | | | | | | | | | | | | | | | | | | | | | | | | | | | | | | | | | | | | | | | | | | | | | | | | | | | | | | | | | | | | | | | | | | | | | | | | | | | | | | | | | | | | | | | | | | | | | | | | | | | | | | | | | | | | | | | | | | | | | | | | | | | | | | | | | | | | | | | | | | | | | | | | | | | | | | | | | | | | | | | | | | | | | | | | | | | | | | | | | | | |
| 4,700 pF | 472 | J | K | M | HE | HE | HE | HE | HE | HG | | JE | JE | JE | JE | JK | JE | KE | KE | KE | KE | KE | KF | KE | 5,600 pF | 562 | J | K | M | HE | HE | HE | HE | HE | HG | | JE | JE | JE | JE | JK | JE | KE | KE | KE | KE | KE | KF | KE | 6,800 pF | 682 | J | K | M | HE | HE | HE | HE | HE | HJ | | JE | JE | JE | JE | JK | JE | KE | KE | KE | KE | KF | KE | KE | 8,200 pF | 822 | J | K | M | HE | HE | HE | HE | HE | HJ | | JE | JE | JE | JE | JK | JK | KE | KE | KE | KE | KF | KF | KF | 10,000 pF | 103 | J | K | M | HE | HE | HE | HE | HJ | HK | | JE | JE | JE | JE | JL | JL | KE | KE | KE | KE | KF | KH | KH | 12,000 pF | 123 | J | K | M | HE | HE | HE | HG | HJ | | | JE | JK | JK | JK | JL | JL | KE | KE | KE | KE | KF | KH | KH | 15,000 pF | 153 | J | K | M | HE | HE | HE | HG | HK | | | JE | JK | JK | JK | JN | JN | KE | KE | KE | KE | KF | KJ | KJ | 18,000 pF | 183 | J | K | M | HE | HE | HE | HG | | | | JE | JK | JK | JK | JN | | KE | KE | KE | KE | KH | | | 22,000 pF | 223 | J | K | M | HE | HG | HG | HG | | | | JE | JK | JK | JK | JN | | KE | KF | KF | KF | KJ | | | 27,000 pF | 273 | J | K | M | HE | HG | HG | HG | | | | JE | JK | JK | JK | | | KE | KF | KF | KF | KJ | | | 33,000 pF | 333 | J | K | M | HE | HG | HG | HE | | | | JE | JK | JK | JK | | | KE | KF | KF | KF | | | | 39,000 pF | 393 | J | K | M | HE | HG | HG | HG | | | | JE | JK | JK | JE | | | KE | KF | KF | KF | | | | 47,000 pF | 473 | J | K | M | HE | HG | HG | HJ | | | | JE | JK | JK | JK | | | KE | KF | KF | KF | | | | 56,000 pF | 563 | J | K | M | HE | HG | HG | HJ | | | | JE | JE | JE | JL | | | KE | KF | KF | KF | | | | 62,000 pF | 623 | J | K | M | HG | HG | HG | HK | | | | JE | JE | JE | JL | | | KF | KF | KF | KH | | | | 68,000 pF | 683 | J | K | M | HG | HJ | HJ | HK | | | | JE | JK | JK | JL | | | KE | KF | KF | KJ | | | | 82,000 pF | 823 | J | K | M | HG | HJ | HJ | | | | | JE | JL | JL | JN | | | KE | KF | KF | KJ | | | | 0.10 µF | 104 | J | K | M | HG | HK | HK | | | | | JE | JN | JN | | | | KE | KH | KH | KJ | | | | 0.12 µF | 124 | J | K | M | HG | | | | | | | JE | JN | JN | | | | KE | KH | KH | KJ | | | | 0.15 µF | 154 | J | K | M | HG | | | | | | | JK | | | | | | KF | KJ | KJ | | | | | 0.18 µF | 184 | J | K | M | HG | | | | | | | JK | | | | | | KF | | | | | | | 0.22 µF | 224 | J | K | M | HG | | | | | | | | | | | | | KF | | | | | | | | | | | | | | | | | | | | | | | | | | | | | | | | | | | | | | | | | | | | | | | | | | | | | | | | | | | | | | | | | | | | | | | | | | | | | | | | | | | | | | | | | | | | | | | | | | | | | | | | | | | | | | | | | | | | | | | | | | | | | | | | | | | | | | | | | | | | | | | | | | | | | | | | | | | | | | | | | | | | | | | | | | | | | | | | | | | | | | | | | | | | | | | | | | | | | | | | | | | | | | | | | | | | | | | | | | | | | | | | | | | | | | | | | | | | | | | | | | | | | | | | | | | | | | | | | | | | | | | | | | | | | | | | | | | | | | | | | | | | | | | | | | | | | | | | | | | | | | | | | | | | | | | | | | | | | | | | | | | | | | | | | | | |
| 5,600 pF | 562 | J | K | M | HE | HE | HE | HE | HE | HG | | JE | JE | JE | JE | JK | JE | KE | KE | KE | KE | KE | KF | KE | 6,800 pF | 682 | J | K | M | HE | HE | HE | HE | HE | HJ | | JE | JE | JE | JE | JK | JE | KE | KE | KE | KE | KF | KE | KE | 8,200 pF | 822 | J | K | M | HE | HE | HE | HE | HE | HJ | | JE | JE | JE | JE | JK | JK | KE | KE | KE | KE | KF | KF | KF | 10,000 pF | 103 | J | K | M | HE | HE | HE | HE | HJ | HK | | JE | JE | JE | JE | JL | JL | KE | KE | KE | KE | KF | KH | KH | 12,000 pF | 123 | J | K | M | HE | HE | HE | HG | HJ | | | JE | JK | JK | JK | JL | JL | KE | KE | KE | KE | KF | KH | KH | 15,000 pF | 153 | J | K | M | HE | HE | HE | HG | HK | | | JE | JK | JK | JK | JN | JN | KE | KE | KE | KE | KF | KJ | KJ | 18,000 pF | 183 | J | K | M | HE | HE | HE | HG | | | | JE | JK | JK | JK | JN | | KE | KE | KE | KE | KH | | | 22,000 pF | 223 | J | K | M | HE | HG | HG | HG | | | | JE | JK | JK | JK | JN | | KE | KF | KF | KF | KJ | | | 27,000 pF | 273 | J | K | M | HE | HG | HG | HG | | | | JE | JK | JK | JK | | | KE | KF | KF | KF | KJ | | | 33,000 pF | 333 | J | K | M | HE | HG | HG | HE | | | | JE | JK | JK | JK | | | KE | KF | KF | KF | | | | 39,000 pF | 393 | J | K | M | HE | HG | HG | HG | | | | JE | JK | JK | JE | | | KE | KF | KF | KF | | | | 47,000 pF | 473 | J | K | M | HE | HG | HG | HJ | | | | JE | JK | JK | JK | | | KE | KF | KF | KF | | | | 56,000 pF | 563 | J | K | M | HE | HG | HG | HJ | | | | JE | JE | JE | JL | | | KE | KF | KF | KF | | | | 62,000 pF | 623 | J | K | M | HG | HG | HG | HK | | | | JE | JE | JE | JL | | | KF | KF | KF | KH | | | | 68,000 pF | 683 | J | K | M | HG | HJ | HJ | HK | | | | JE | JK | JK | JL | | | KE | KF | KF | KJ | | | | 82,000 pF | 823 | J | K | M | HG | HJ | HJ | | | | | JE | JL | JL | JN | | | KE | KF | KF | KJ | | | | 0.10 µF | 104 | J | K | M | HG | HK | HK | | | | | JE | JN | JN | | | | KE | KH | KH | KJ | | | | 0.12 µF | 124 | J | K | M | HG | | | | | | | JE | JN | JN | | | | KE | KH | KH | KJ | | | | 0.15 µF | 154 | J | K | M | HG | | | | | | | JK | | | | | | KF | KJ | KJ | | | | | 0.18 µF | 184 | J | K | M | HG | | | | | | | JK | | | | | | KF | | | | | | | 0.22 µF | 224 | J | K | M | HG | | | | | | | | | | | | | KF | | | | | | | | | | | | | | | | | | | | | | | | | | | | | | | | | | | | | | | | | | | | | | | | | | | | | | | | | | | | | | | | | | | | | | | | | | | | | | | | | | | | | | | | | | | | | | | | | | | | | | | | | | | | | | | | | | | | | | | | | | | | | | | | | | | | | | | | | | | | | | | | | | | | | | | | | | | | | | | | | | | | | | | | | | | | | | | | | | | | | | | | | | | | | | | | | | | | | | | | | | | | | | | | | | | | | | | | | | | | | | | | | | | | | | | | | | | | | | | | | | | | | | | | | | | | | | | | | | | | | | | | | | | | | | | | | | | | | | | | | | | | | | | | | | | | | | | | | | | | | | | | | | | | | | | | | | | | | | | | | | | | | | | | | | | | | | | | | | | | | | | | | | | | | | | | | | | | |
| 6,800 pF | 682 | J | K | M | HE | HE | HE | HE | HE | HJ | | JE | JE | JE | JE | JK | JE | KE | KE | KE | KE | KF | KE | KE | 8,200 pF | 822 | J | K | M | HE | HE | HE | HE | HE | HJ | | JE | JE | JE | JE | JK | JK | KE | KE | KE | KE | KF | KF | KF | 10,000 pF | 103 | J | K | M | HE | HE | HE | HE | HJ | HK | | JE | JE | JE | JE | JL | JL | KE | KE | KE | KE | KF | KH | KH | 12,000 pF | 123 | J | K | M | HE | HE | HE | HG | HJ | | | JE | JK | JK | JK | JL | JL | KE | KE | KE | KE | KF | KH | KH | 15,000 pF | 153 | J | K | M | HE | HE | HE | HG | HK | | | JE | JK | JK | JK | JN | JN | KE | KE | KE | KE | KF | KJ | KJ | 18,000 pF | 183 | J | K | M | HE | HE | HE | HG | | | | JE | JK | JK | JK | JN | | KE | KE | KE | KE | KH | | | 22,000 pF | 223 | J | K | M | HE | HG | HG | HG | | | | JE | JK | JK | JK | JN | | KE | KF | KF | KF | KJ | | | 27,000 pF | 273 | J | K | M | HE | HG | HG | HG | | | | JE | JK | JK | JK | | | KE | KF | KF | KF | KJ | | | 33,000 pF | 333 | J | K | M | HE | HG | HG | HE | | | | JE | JK | JK | JK | | | KE | KF | KF | KF | | | | 39,000 pF | 393 | J | K | M | HE | HG | HG | HG | | | | JE | JK | JK | JE | | | KE | KF | KF | KF | | | | 47,000 pF | 473 | J | K | M | HE | HG | HG | HJ | | | | JE | JK | JK | JK | | | KE | KF | KF | KF | | | | 56,000 pF | 563 | J | K | M | HE | HG | HG | HJ | | | | JE | JE | JE | JL | | | KE | KF | KF | KF | | | | 62,000 pF | 623 | J | K | M | HG | HG | HG | HK | | | | JE | JE | JE | JL | | | KF | KF | KF | KH | | | | 68,000 pF | 683 | J | K | M | HG | HJ | HJ | HK | | | | JE | JK | JK | JL | | | KE | KF | KF | KJ | | | | 82,000 pF | 823 | J | K | M | HG | HJ | HJ | | | | | JE | JL | JL | JN | | | KE | KF | KF | KJ | | | | 0.10 µF | 104 | J | K | M | HG | HK | HK | | | | | JE | JN | JN | | | | KE | KH | KH | KJ | | | | 0.12 µF | 124 | J | K | M | HG | | | | | | | JE | JN | JN | | | | KE | KH | KH | KJ | | | | 0.15 µF | 154 | J | K | M | HG | | | | | | | JK | | | | | | KF | KJ | KJ | | | | | 0.18 µF | 184 | J | K | M | HG | | | | | | | JK | | | | | | KF | | | | | | | 0.22 µF | 224 | J | K | M | HG | | | | | | | | | | | | | KF | | | | | | | | | | | | | | | | | | | | | | | | | | | | | | | | | | | | | | | | | | | | | | | | | | | | | | | | | | | | | | | | | | | | | | | | | | | | | | | | | | | | | | | | | | | | | | | | | | | | | | | | | | | | | | | | | | | | | | | | | | | | | | | | | | | | | | | | | | | | | | | | | | | | | | | | | | | | | | | | | | | | | | | | | | | | | | | | | | | | | | | | | | | | | | | | | | | | | | | | | | | | | | | | | | | | | | | | | | | | | | | | | | | | | | | | | | | | | | | | | | | | | | | | | | | | | | | | | | | | | | | | | | | | | | | | | | | | | | | | | | | | | | | | | | | | | | | | | | | | | | | | | | | | | | | | | | | | | | | | | | | | | | | | | | | | | | | | | | | | | | | | | | | | | | | | | | | | | | | | | | | | | | | | | | | | | | | | | | | | | |
| 8,200 pF | 822 | J | K | M | HE | HE | HE | HE | HE | HJ | | JE | JE | JE | JE | JK | JK | KE | KE | KE | KE | KF | KF | KF | 10,000 pF | 103 | J | K | M | HE | HE | HE | HE | HJ | HK | | JE | JE | JE | JE | JL | JL | KE | KE | KE | KE | KF | KH | KH | 12,000 pF | 123 | J | K | M | HE | HE | HE | HG | HJ | | | JE | JK | JK | JK | JL | JL | KE | KE | KE | KE | KF | KH | KH | 15,000 pF | 153 | J | K | M | HE | HE | HE | HG | HK | | | JE | JK | JK | JK | JN | JN | KE | KE | KE | KE | KF | KJ | KJ | 18,000 pF | 183 | J | K | M | HE | HE | HE | HG | | | | JE | JK | JK | JK | JN | | KE | KE | KE | KE | KH | | | 22,000 pF | 223 | J | K | M | HE | HG | HG | HG | | | | JE | JK | JK | JK | JN | | KE | KF | KF | KF | KJ | | | 27,000 pF | 273 | J | K | M | HE | HG | HG | HG | | | | JE | JK | JK | JK | | | KE | KF | KF | KF | KJ | | | 33,000 pF | 333 | J | K | M | HE | HG | HG | HE | | | | JE | JK | JK | JK | | | KE | KF | KF | KF | | | | 39,000 pF | 393 | J | K | M | HE | HG | HG | HG | | | | JE | JK | JK | JE | | | KE | KF | KF | KF | | | | 47,000 pF | 473 | J | K | M | HE | HG | HG | HJ | | | | JE | JK | JK | JK | | | KE | KF | KF | KF | | | | 56,000 pF | 563 | J | K | M | HE | HG | HG | HJ | | | | JE | JE | JE | JL | | | KE | KF | KF | KF | | | | 62,000 pF | 623 | J | K | M | HG | HG | HG | HK | | | | JE | JE | JE | JL | | | KF | KF | KF | KH | | | | 68,000 pF | 683 | J | K | M | HG | HJ | HJ | HK | | | | JE | JK | JK | JL | | | KE | KF | KF | KJ | | | | 82,000 pF | 823 | J | K | M | HG | HJ | HJ | | | | | JE | JL | JL | JN | | | KE | KF | KF | KJ | | | | 0.10 µF | 104 | J | K | M | HG | HK | HK | | | | | JE | JN | JN | | | | KE | KH | KH | KJ | | | | 0.12 µF | 124 | J | K | M | HG | | | | | | | JE | JN | JN | | | | KE | KH | KH | KJ | | | | 0.15 µF | 154 | J | K | M | HG | | | | | | | JK | | | | | | KF | KJ | KJ | | | | | 0.18 µF | 184 | J | K | M | HG | | | | | | | JK | | | | | | KF | | | | | | | 0.22 µF | 224 | J | K | M | HG | | | | | | | | | | | | | KF | | | | | | | | | | | | | | | | | | | | | | | | | | | | | | | | | | | | | | | | | | | | | | | | | | | | | | | | | | | | | | | | | | | | | | | | | | | | | | | | | | | | | | | | | | | | | | | | | | | | | | | | | | | | | | | | | | | | | | | | | | | | | | | | | | | | | | | | | | | | | | | | | | | | | | | | | | | | | | | | | | | | | | | | | | | | | | | | | | | | | | | | | | | | | | | | | | | | | | | | | | | | | | | | | | | | | | | | | | | | | | | | | | | | | | | | | | | | | | | | | | | | | | | | | | | | | | | | | | | | | | | | | | | | | | | | | | | | | | | | | | | | | | | | | | | | | | | | | | | | | | | | | | | | | | | | | | | | | | | | | | | | | | | | | | | | | | | | | | | | | | | | | | | | | | | | | | | | | | | | | | | | | | | | | | | | | | | | | | | | | | | | | | | | | | | | | | | | | | | | | | | | | | |
| 10,000 pF | 103 | J | K | M | HE | HE | HE | HE | HJ | HK | | JE | JE | JE | JE | JL | JL | KE | KE | KE | KE | KF | KH | KH | 12,000 pF | 123 | J | K | M | HE | HE | HE | HG | HJ | | | JE | JK | JK | JK | JL | JL | KE | KE | KE | KE | KF | KH | KH | 15,000 pF | 153 | J | K | M | HE | HE | HE | HG | HK | | | JE | JK | JK | JK | JN | JN | KE | KE | KE | KE | KF | KJ | KJ | 18,000 pF | 183 | J | K | M | HE | HE | HE | HG | | | | JE | JK | JK | JK | JN | | KE | KE | KE | KE | KH | | | 22,000 pF | 223 | J | K | M | HE | HG | HG | HG | | | | JE | JK | JK | JK | JN | | KE | KF | KF | KF | KJ | | | 27,000 pF | 273 | J | K | M | HE | HG | HG | HG | | | | JE | JK | JK | JK | | | KE | KF | KF | KF | KJ | | | 33,000 pF | 333 | J | K | M | HE | HG | HG | HE | | | | JE | JK | JK | JK | | | KE | KF | KF | KF | | | | 39,000 pF | 393 | J | K | M | HE | HG | HG | HG | | | | JE | JK | JK | JE | | | KE | KF | KF | KF | | | | 47,000 pF | 473 | J | K | M | HE | HG | HG | HJ | | | | JE | JK | JK | JK | | | KE | KF | KF | KF | | | | 56,000 pF | 563 | J | K | M | HE | HG | HG | HJ | | | | JE | JE | JE | JL | | | KE | KF | KF | KF | | | | 62,000 pF | 623 | J | K | M | HG | HG | HG | HK | | | | JE | JE | JE | JL | | | KF | KF | KF | KH | | | | 68,000 pF | 683 | J | K | M | HG | HJ | HJ | HK | | | | JE | JK | JK | JL | | | KE | KF | KF | KJ | | | | 82,000 pF | 823 | J | K | M | HG | HJ | HJ | | | | | JE | JL | JL | JN | | | KE | KF | KF | KJ | | | | 0.10 µF | 104 | J | K | M | HG | HK | HK | | | | | JE | JN | JN | | | | KE | KH | KH | KJ | | | | 0.12 µF | 124 | J | K | M | HG | | | | | | | JE | JN | JN | | | | KE | KH | KH | KJ | | | | 0.15 µF | 154 | J | K | M | HG | | | | | | | JK | | | | | | KF | KJ | KJ | | | | | 0.18 µF | 184 | J | K | M | HG | | | | | | | JK | | | | | | KF | | | | | | | 0.22 µF | 224 | J | K | M | HG | | | | | | | | | | | | | KF | | | | | | | | | | | | | | | | | | | | | | | | | | | | | | | | | | | | | | | | | | | | | | | | | | | | | | | | | | | | | | | | | | | | | | | | | | | | | | | | | | | | | | | | | | | | | | | | | | | | | | | | | | | | | | | | | | | | | | | | | | | | | | | | | | | | | | | | | | | | | | | | | | | | | | | | | | | | | | | | | | | | | | | | | | | | | | | | | | | | | | | | | | | | | | | | | | | | | | | | | | | | | | | | | | | | | | | | | | | | | | | | | | | | | | | | | | | | | | | | | | | | | | | | | | | | | | | | | | | | | | | | | | | | | | | | | | | | | | | | | | | | | | | | | | | | | | | | | | | | | | | | | | | | | | | | | | | | | | | | | | | | | | | | | | | | | | | | | | | | | | | | | | | | | | | | | | | | | | | | | | | | | | | | | | | | | | | | | | | | | | | | | | | | | | | | | | | | | | | | | | | | | | | | | | | | | | | | | | | | | | | | | | | | | | | |
| 12,000 pF | 123 | J | K | M | HE | HE | HE | HG | HJ | | | JE | JK | JK | JK | JL | JL | KE | KE | KE | KE | KF | KH | KH | 15,000 pF | 153 | J | K | M | HE | HE | HE | HG | HK | | | JE | JK | JK | JK | JN | JN | KE | KE | KE | KE | KF | KJ | KJ | 18,000 pF | 183 | J | K | M | HE | HE | HE | HG | | | | JE | JK | JK | JK | JN | | KE | KE | KE | KE | KH | | | 22,000 pF | 223 | J | K | M | HE | HG | HG | HG | | | | JE | JK | JK | JK | JN | | KE | KF | KF | KF | KJ | | | 27,000 pF | 273 | J | K | M | HE | HG | HG | HG | | | | JE | JK | JK | JK | | | KE | KF | KF | KF | KJ | | | 33,000 pF | 333 | J | K | M | HE | HG | HG | HE | | | | JE | JK | JK | JK | | | KE | KF | KF | KF | | | | 39,000 pF | 393 | J | K | M | HE | HG | HG | HG | | | | JE | JK | JK | JE | | | KE | KF | KF | KF | | | | 47,000 pF | 473 | J | K | M | HE | HG | HG | HJ | | | | JE | JK | JK | JK | | | KE | KF | KF | KF | | | | 56,000 pF | 563 | J | K | M | HE | HG | HG | HJ | | | | JE | JE | JE | JL | | | KE | KF | KF | KF | | | | 62,000 pF | 623 | J | K | M | HG | HG | HG | HK | | | | JE | JE | JE | JL | | | KF | KF | KF | KH | | | | 68,000 pF | 683 | J | K | M | HG | HJ | HJ | HK | | | | JE | JK | JK | JL | | | KE | KF | KF | KJ | | | | 82,000 pF | 823 | J | K | M | HG | HJ | HJ | | | | | JE | JL | JL | JN | | | KE | KF | KF | KJ | | | | 0.10 µF | 104 | J | K | M | HG | HK | HK | | | | | JE | JN | JN | | | | KE | KH | KH | KJ | | | | 0.12 µF | 124 | J | K | M | HG | | | | | | | JE | JN | JN | | | | KE | KH | KH | KJ | | | | 0.15 µF | 154 | J | K | M | HG | | | | | | | JK | | | | | | KF | KJ | KJ | | | | | 0.18 µF | 184 | J | K | M | HG | | | | | | | JK | | | | | | KF | | | | | | | 0.22 µF | 224 | J | K | M | HG | | | | | | | | | | | | | KF | | | | | | | | | | | | | | | | | | | | | | | | | | | | | | | | | | | | | | | | | | | | | | | | | | | | | | | | | | | | | | | | | | | | | | | | | | | | | | | | | | | | | | | | | | | | | | | | | | | | | | | | | | | | | | | | | | | | | | | | | | | | | | | | | | | | | | | | | | | | | | | | | | | | | | | | | | | | | | | | | | | | | | | | | | | | | | | | | | | | | | | | | | | | | | | | | | | | | | | | | | | | | | | | | | | | | | | | | | | | | | | | | | | | | | | | | | | | | | | | | | | | | | | | | | | | | | | | | | | | | | | | | | | | | | | | | | | | | | | | | | | | | | | | | | | | | | | | | | | | | | | | | | | | | | | | | | | | | | | | | | | | | | | | | | | | | | | | | | | | | | | | | | | | | | | | | | | | | | | | | | | | | | | | | | | | | | | | | | | | | | | | | | | | | | | | | | | | | | | | | | | | | | | | | | | | | | | | | | | | | | | | | | | | | | | | | | | | | | | | | | | | | | | | | | | | | | | | |
| 15,000 pF | 153 | J | K | M | HE | HE | HE | HG | HK | | | JE | JK | JK | JK | JN | JN | KE | KE | KE | KE | KF | KJ | KJ | 18,000 pF | 183 | J | K | M | HE | HE | HE | HG | | | | JE | JK | JK | JK | JN | | KE | KE | KE | KE | KH | | | 22,000 pF | 223 | J | K | M | HE | HG | HG | HG | | | | JE | JK | JK | JK | JN | | KE | KF | KF | KF | KJ | | | 27,000 pF | 273 | J | K | M | HE | HG | HG | HG | | | | JE | JK | JK | JK | | | KE | KF | KF | KF | KJ | | | 33,000 pF | 333 | J | K | M | HE | HG | HG | HE | | | | JE | JK | JK | JK | | | KE | KF | KF | KF | | | | 39,000 pF | 393 | J | K | M | HE | HG | HG | HG | | | | JE | JK | JK | JE | | | KE | KF | KF | KF | | | | 47,000 pF | 473 | J | K | M | HE | HG | HG | HJ | | | | JE | JK | JK | JK | | | KE | KF | KF | KF | | | | 56,000 pF | 563 | J | K | M | HE | HG | HG | HJ | | | | JE | JE | JE | JL | | | KE | KF | KF | KF | | | | 62,000 pF | 623 | J | K | M | HG | HG | HG | HK | | | | JE | JE | JE | JL | | | KF | KF | KF | KH | | | | 68,000 pF | 683 | J | K | M | HG | HJ | HJ | HK | | | | JE | JK | JK | JL | | | KE | KF | KF | KJ | | | | 82,000 pF | 823 | J | K | M | HG | HJ | HJ | | | | | JE | JL | JL | JN | | | KE | KF | KF | KJ | | | | 0.10 µF | 104 | J | K | M | HG | HK | HK | | | | | JE | JN | JN | | | | KE | KH | KH | KJ | | | | 0.12 µF | 124 | J | K | M | HG | | | | | | | JE | JN | JN | | | | KE | KH | KH | KJ | | | | 0.15 µF | 154 | J | K | M | HG | | | | | | | JK | | | | | | KF | KJ | KJ | | | | | 0.18 µF | 184 | J | K | M | HG | | | | | | | JK | | | | | | KF | | | | | | | 0.22 µF | 224 | J | K | M | HG | | | | | | | | | | | | | KF | | | | | | | | | | | | | | | | | | | | | | | | | | | | | | | | | | | | | | | | | | | | | | | | | | | | | | | | | | | | | | | | | | | | | | | | | | | | | | | | | | | | | | | | | | | | | | | | | | | | | | | | | | | | | | | | | | | | | | | | | | | | | | | | | | | | | | | | | | | | | | | | | | | | | | | | | | | | | | | | | | | | | | | | | | | | | | | | | | | | | | | | | | | | | | | | | | | | | | | | | | | | | | | | | | | | | | | | | | | | | | | | | | | | | | | | | | | | | | | | | | | | | | | | | | | | | | | | | | | | | | | | | | | | | | | | | | | | | | | | | | | | | | | | | | | | | | | | | | | | | | | | | | | | | | | | | | | | | | | | | | | | | | | | | | | | | | | | | | | | | | | | | | | | | | | | | | | | | | | | | | | | | | | | | | | | | | | | | | | | | | | | | | | | | | | | | | | | | | | | | | | | | | | | | | | | | | | | | | | | | | | | | | | | | | | | | | | | | | | | | | | | | | | | | | | | | | | | | | | | | | | | | | | | | | | | | | | | | | | | | |
| 18,000 pF | 183 | J | K | M | HE | HE | HE | HG | | | | JE | JK | JK | JK | JN | | KE | KE | KE | KE | KH | | | 22,000 pF | 223 | J | K | M | HE | HG | HG | HG | | | | JE | JK | JK | JK | JN | | KE | KF | KF | KF | KJ | | | 27,000 pF | 273 | J | K | M | HE | HG | HG | HG | | | | JE | JK | JK | JK | | | KE | KF | KF | KF | KJ | | | 33,000 pF | 333 | J | K | M | HE | HG | HG | HE | | | | JE | JK | JK | JK | | | KE | KF | KF | KF | | | | 39,000 pF | 393 | J | K | M | HE | HG | HG | HG | | | | JE | JK | JK | JE | | | KE | KF | KF | KF | | | | 47,000 pF | 473 | J | K | M | HE | HG | HG | HJ | | | | JE | JK | JK | JK | | | KE | KF | KF | KF | | | | 56,000 pF | 563 | J | K | M | HE | HG | HG | HJ | | | | JE | JE | JE | JL | | | KE | KF | KF | KF | | | | 62,000 pF | 623 | J | K | M | HG | HG | HG | HK | | | | JE | JE | JE | JL | | | KF | KF | KF | KH | | | | 68,000 pF | 683 | J | K | M | HG | HJ | HJ | HK | | | | JE | JK | JK | JL | | | KE | KF | KF | KJ | | | | 82,000 pF | 823 | J | K | M | HG | HJ | HJ | | | | | JE | JL | JL | JN | | | KE | KF | KF | KJ | | | | 0.10 µF | 104 | J | K | M | HG | HK | HK | | | | | JE | JN | JN | | | | KE | KH | KH | KJ | | | | 0.12 µF | 124 | J | K | M | HG | | | | | | | JE | JN | JN | | | | KE | KH | KH | KJ | | | | 0.15 µF | 154 | J | K | M | HG | | | | | | | JK | | | | | | KF | KJ | KJ | | | | | 0.18 µF | 184 | J | K | M | HG | | | | | | | JK | | | | | | KF | | | | | | | 0.22 µF | 224 | J | K | M | HG | | | | | | | | | | | | | KF | | | | | | | | | | | | | | | | | | | | | | | | | | | | | | | | | | | | | | | | | | | | | | | | | | | | | | | | | | | | | | | | | | | | | | | | | | | | | | | | | | | | | | | | | | | | | | | | | | | | | | | | | | | | | | | | | | | | | | | | | | | | | | | | | | | | | | | | | | | | | | | | | | | | | | | | | | | | | | | | | | | | | | | | | | | | | | | | | | | | | | | | | | | | | | | | | | | | | | | | | | | | | | | | | | | | | | | | | | | | | | | | | | | | | | | | | | | | | | | | | | | | | | | | | | | | | | | | | | | | | | | | | | | | | | | | | | | | | | | | | | | | | | | | | | | | | | | | | | | | | | | | | | | | | | | | | | | | | | | | | | | | | | | | | | | | | | | | | | | | | | | | | | | | | | | | | | | | | | | | | | | | | | | | | | | | | | | | | | | | | | | | | | | | | | | | | | | | | | | | | | | | | | | | | | | | | | | | | | | | | | | | | | | | | | | | | | | | | | | | | | | | | | | | | | | | | | | | | | | | | | | | | | | | | | | | | | | | | | | | | | | | | | | | | | | | | | | | | | | | | | | | | | |
| 22,000 pF | 223 | J | K | M | HE | HG | HG | HG | | | | JE | JK | JK | JK | JN | | KE | KF | KF | KF | KJ | | | 27,000 pF | 273 | J | K | M | HE | HG | HG | HG | | | | JE | JK | JK | JK | | | KE | KF | KF | KF | KJ | | | 33,000 pF | 333 | J | K | M | HE | HG | HG | HE | | | | JE | JK | JK | JK | | | KE | KF | KF | KF | | | | 39,000 pF | 393 | J | K | M | HE | HG | HG | HG | | | | JE | JK | JK | JE | | | KE | KF | KF | KF | | | | 47,000 pF | 473 | J | K | M | HE | HG | HG | HJ | | | | JE | JK | JK | JK | | | KE | KF | KF | KF | | | | 56,000 pF | 563 | J | K | M | HE | HG | HG | HJ | | | | JE | JE | JE | JL | | | KE | KF | KF | KF | | | | 62,000 pF | 623 | J | K | M | HG | HG | HG | HK | | | | JE | JE | JE | JL | | | KF | KF | KF | KH | | | | 68,000 pF | 683 | J | K | M | HG | HJ | HJ | HK | | | | JE | JK | JK | JL | | | KE | KF | KF | KJ | | | | 82,000 pF | 823 | J | K | M | HG | HJ | HJ | | | | | JE | JL | JL | JN | | | KE | KF | KF | KJ | | | | 0.10 µF | 104 | J | K | M | HG | HK | HK | | | | | JE | JN | JN | | | | KE | KH | KH | KJ | | | | 0.12 µF | 124 | J | K | M | HG | | | | | | | JE | JN | JN | | | | KE | KH | KH | KJ | | | | 0.15 µF | 154 | J | K | M | HG | | | | | | | JK | | | | | | KF | KJ | KJ | | | | | 0.18 µF | 184 | J | K | M | HG | | | | | | | JK | | | | | | KF | | | | | | | 0.22 µF | 224 | J | K | M | HG | | | | | | | | | | | | | KF | | | | | | | | | | | | | | | | | | | | | | | | | | | | | | | | | | | | | | | | | | | | | | | | | | | | | | | | | | | | | | | | | | | | | | | | | | | | | | | | | | | | | | | | | | | | | | | | | | | | | | | | | | | | | | | | | | | | | | | | | | | | | | | | | | | | | | | | | | | | | | | | | | | | | | | | | | | | | | | | | | | | | | | | | | | | | | | | | | | | | | | | | | | | | | | | | | | | | | | | | | | | | | | | | | | | | | | | | | | | | | | | | | | | | | | | | | | | | | | | | | | | | | | | | | | | | | | | | | | | | | | | | | | | | | | | | | | | | | | | | | | | | | | | | | | | | | | | | | | | | | | | | | | | | | | | | | | | | | | | | | | | | | | | | | | | | | | | | | | | | | | | | | | | | | | | | | | | | | | | | | | | | | | | | | | | | | | | | | | | | | | | | | | | | | | | | | | | | | | | | | | | | | | | | | | | | | | | | | | | | | | | | | | | | | | | | | | | | | | | | | | | | | | | | | | | | | | | | | | | | | | | | | | | | | | | | | | | | | | | | | | | | | | | | | | | | | | | | | | | | | | | | | | | | | | | | | | | | | | | | | | | | | | | | | | |
| 27,000 pF | 273 | J | K | M | HE | HG | HG | HG | | | | JE | JK | JK | JK | | | KE | KF | KF | KF | KJ | | | 33,000 pF | 333 | J | K | M | HE | HG | HG | HE | | | | JE | JK | JK | JK | | | KE | KF | KF | KF | | | | 39,000 pF | 393 | J | K | M | HE | HG | HG | HG | | | | JE | JK | JK | JE | | | KE | KF | KF | KF | | | | 47,000 pF | 473 | J | K | M | HE | HG | HG | HJ | | | | JE | JK | JK | JK | | | KE | KF | KF | KF | | | | 56,000 pF | 563 | J | K | M | HE | HG | HG | HJ | | | | JE | JE | JE | JL | | | KE | KF | KF | KF | | | | 62,000 pF | 623 | J | K | M | HG | HG | HG | HK | | | | JE | JE | JE | JL | | | KF | KF | KF | KH | | | | 68,000 pF | 683 | J | K | M | HG | HJ | HJ | HK | | | | JE | JK | JK | JL | | | KE | KF | KF | KJ | | | | 82,000 pF | 823 | J | K | M | HG | HJ | HJ | | | | | JE | JL | JL | JN | | | KE | KF | KF | KJ | | | | 0.10 µF | 104 | J | K | M | HG | HK | HK | | | | | JE | JN | JN | | | | KE | KH | KH | KJ | | | | 0.12 µF | 124 | J | K | M | HG | | | | | | | JE | JN | JN | | | | KE | KH | KH | KJ | | | | 0.15 µF | 154 | J | K | M | HG | | | | | | | JK | | | | | | KF | KJ | KJ | | | | | 0.18 µF | 184 | J | K | M | HG | | | | | | | JK | | | | | | KF | | | | | | | 0.22 µF | 224 | J | K | M | HG | | | | | | | | | | | | | KF | | | | | | | | | | | | | | | | | | | | | | | | | | | | | | | | | | | | | | | | | | | | | | | | | | | | | | | | | | | | | | | | | | | | | | | | | | | | | | | | | | | | | | | | | | | | | | | | | | | | | | | | | | | | | | | | | | | | | | | | | | | | | | | | | | | | | | | | | | | | | | | | | | | | | | | | | | | | | | | | | | | | | | | | | | | | | | | | | | | | | | | | | | | | | | | | | | | | | | | | | | | | | | | | | | | | | | | | | | | | | | | | | | | | | | | | | | | | | | | | | | | | | | | | | | | | | | | | | | | | | | | | | | | | | | | | | | | | | | | | | | | | | | | | | | | | | | | | | | | | | | | | | | | | | | | | | | | | | | | | | | | | | | | | | | | | | | | | | | | | | | | | | | | | | | | | | | | | | | | | | | | | | | | | | | | | | | | | | | | | | | | | | | | | | | | | | | | | | | | | | | | | | | | | | | | | | | | | | | | | | | | | | | | | | | | | | | | | | | | | | | | | | | | | | | | | | | | | | | | | | | | | | | | | | | | | | | | | | | | | | | | | | | | | | | | | | | | | | | | | | | | | | | | | | | | | | | | | | | | | | | | | | | | | | | | | | | | | | | | | | | | | | | | | | | | | | | | | |
| 33,000 pF | 333 | J | K | M | HE | HG | HG | HE | | | | JE | JK | JK | JK | | | KE | KF | KF | KF | | | | 39,000 pF | 393 | J | K | M | HE | HG | HG | HG | | | | JE | JK | JK | JE | | | KE | KF | KF | KF | | | | 47,000 pF | 473 | J | K | M | HE | HG | HG | HJ | | | | JE | JK | JK | JK | | | KE | KF | KF | KF | | | | 56,000 pF | 563 | J | K | M | HE | HG | HG | HJ | | | | JE | JE | JE | JL | | | KE | KF | KF | KF | | | | 62,000 pF | 623 | J | K | M | HG | HG | HG | HK | | | | JE | JE | JE | JL | | | KF | KF | KF | KH | | | | 68,000 pF | 683 | J | K | M | HG | HJ | HJ | HK | | | | JE | JK | JK | JL | | | KE | KF | KF | KJ | | | | 82,000 pF | 823 | J | K | M | HG | HJ | HJ | | | | | JE | JL | JL | JN | | | KE | KF | KF | KJ | | | | 0.10 µF | 104 | J | K | M | HG | HK | HK | | | | | JE | JN | JN | | | | KE | KH | KH | KJ | | | | 0.12 µF | 124 | J | K | M | HG | | | | | | | JE | JN | JN | | | | KE | KH | KH | KJ | | | | 0.15 µF | 154 | J | K | M | HG | | | | | | | JK | | | | | | KF | KJ | KJ | | | | | 0.18 µF | 184 | J | K | M | HG | | | | | | | JK | | | | | | KF | | | | | | | 0.22 µF | 224 | J | K | M | HG | | | | | | | | | | | | | KF | | | | | | | | | | | | | | | | | | | | | | | | | | | | | | | | | | | | | | | | | | | | | | | | | | | | | | | | | | | | | | | | | | | | | | | | | | | | | | | | | | | | | | | | | | | | | | | | | | | | | | | | | | | | | | | | | | | | | | | | | | | | | | | | | | | | | | | | | | | | | | | | | | | | | | | | | | | | | | | | | | | | | | | | | | | | | | | | | | | | | | | | | | | | | | | | | | | | | | | | | | | | | | | | | | | | | | | | | | | | | | | | | | | | | | | | | | | | | | | | | | | | | | | | | | | | | | | | | | | | | | | | | | | | | | | | | | | | | | | | | | | | | | | | | | | | | | | | | | | | | | | | | | | | | | | | | | | | | | | | | | | | | | | | | | | | | | | | | | | | | | | | | | | | | | | | | | | | | | | | | | | | | | | | | | | | | | | | | | | | | | | | | | | | | | | | | | | | | | | | | | | | | | | | | | | | | | | | | | | | | | | | | | | | | | | | | | | | | | | | | | | | | | | | | | | | | | | | | | | | | | | | | | | | | | | | | | | | | | | | | | | | | | | | | | | | | | | | | | | | | | | | | | | | | | | | | | | | | | | | | | | | | | | | | | | | | | | | | | | | | | | | | | | | | | | | | | | | | | | | | | | | | | | | | | | | | | | | | | | | | |
| 39,000 pF | 393 | J | K | M | HE | HG | HG | HG | | | | JE | JK | JK | JE | | | KE | KF | KF | KF | | | | 47,000 pF | 473 | J | K | M | HE | HG | HG | HJ | | | | JE | JK | JK | JK | | | KE | KF | KF | KF | | | | 56,000 pF | 563 | J | K | M | HE | HG | HG | HJ | | | | JE | JE | JE | JL | | | KE | KF | KF | KF | | | | 62,000 pF | 623 | J | K | M | HG | HG | HG | HK | | | | JE | JE | JE | JL | | | KF | KF | KF | KH | | | | 68,000 pF | 683 | J | K | M | HG | HJ | HJ | HK | | | | JE | JK | JK | JL | | | KE | KF | KF | KJ | | | | 82,000 pF | 823 | J | K | M | HG | HJ | HJ | | | | | JE | JL | JL | JN | | | KE | KF | KF | KJ | | | | 0.10 µF | 104 | J | K | M | HG | HK | HK | | | | | JE | JN | JN | | | | KE | KH | KH | KJ | | | | 0.12 µF | 124 | J | K | M | HG | | | | | | | JE | JN | JN | | | | KE | KH | KH | KJ | | | | 0.15 µF | 154 | J | K | M | HG | | | | | | | JK | | | | | | KF | KJ | KJ | | | | | 0.18 µF | 184 | J | K | M | HG | | | | | | | JK | | | | | | KF | | | | | | | 0.22 µF | 224 | J | K | M | HG | | | | | | | | | | | | | KF | | | | | | | | | | | | | | | | | | | | | | | | | | | | | | | | | | | | | | | | | | | | | | | | | | | | | | | | | | | | | | | | | | | | | | | | | | | | | | | | | | | | | | | | | | | | | | | | | | | | | | | | | | | | | | | | | | | | | | | | | | | | | | | | | | | | | | | | | | | | | | | | | | | | | | | | | | | | | | | | | | | | | | | | | | | | | | | | | | | | | | | | | | | | | | | | | | | | | | | | | | | | | | | | | | | | | | | | | | | | | | | | | | | | | | | | | | | | | | | | | | | | | | | | | | | | | | | | | | | | | | | | | | | | | | | | | | | | | | | | | | | | | | | | | | | | | | | | | | | | | | | | | | | | | | | | | | | | | | | | | | | | | | | | | | | | | | | | | | | | | | | | | | | | | | | | | | | | | | | | | | | | | | | | | | | | | | | | | | | | | | | | | | | | | | | | | | | | | | | | | | | | | | | | | | | | | | | | | | | | | | | | | | | | | | | | | | | | | | | | | | | | | | | | | | | | | | | | | | | | | | | | | | | | | | | | | | | | | | | | | | | | | | | | | | | | | | | | | | | | | | | | | | | | | | | | | | | | | | | | | | | | | | | | | | | | | | | | | | | | | | | | | | | | | | | | | | | | | | | | | | | | | | | | | | | | | | | | | | | | | | | | | | | | | | | | | | | | | | | | | | | | | | |
| 47,000 pF | 473 | J | K | M | HE | HG | HG | HJ | | | | JE | JK | JK | JK | | | KE | KF | KF | KF | | | | 56,000 pF | 563 | J | K | M | HE | HG | HG | HJ | | | | JE | JE | JE | JL | | | KE | KF | KF | KF | | | | 62,000 pF | 623 | J | K | M | HG | HG | HG | HK | | | | JE | JE | JE | JL | | | KF | KF | KF | KH | | | | 68,000 pF | 683 | J | K | M | HG | HJ | HJ | HK | | | | JE | JK | JK | JL | | | KE | KF | KF | KJ | | | | 82,000 pF | 823 | J | K | M | HG | HJ | HJ | | | | | JE | JL | JL | JN | | | KE | KF | KF | KJ | | | | 0.10 µF | 104 | J | K | M | HG | HK | HK | | | | | JE | JN | JN | | | | KE | KH | KH | KJ | | | | 0.12 µF | 124 | J | K | M | HG | | | | | | | JE | JN | JN | | | | KE | KH | KH | KJ | | | | 0.15 µF | 154 | J | K | M | HG | | | | | | | JK | | | | | | KF | KJ | KJ | | | | | 0.18 µF | 184 | J | K | M | HG | | | | | | | JK | | | | | | KF | | | | | | | 0.22 µF | 224 | J | K | M | HG | | | | | | | | | | | | | KF | | | | | | | | | | | | | | | | | | | | | | | | | | | | | | | | | | | | | | | | | | | | | | | | | | | | | | | | | | | | | | | | | | | | | | | | | | | | | | | | | | | | | | | | | | | | | | | | | | | | | | | | | | | | | | | | | | | | | | | | | | | | | | | | | | | | | | | | | | | | | | | | | | | | | | | | | | | | | | | | | | | | | | | | | | | | | | | | | | | | | | | | | | | | | | | | | | | | | | | | | | | | | | | | | | | | | | | | | | | | | | | | | | | | | | | | | | | | | | | | | | | | | | | | | | | | | | | | | | | | | | | | | | | | | | | | | | | | | | | | | | | | | | | | | | | | | | | | | | | | | | | | | | | | | | | | | | | | | | | | | | | | | | | | | | | | | | | | | | | | | | | | | | | | | | | | | | | | | | | | | | | | | | | | | | | | | | | | | | | | | | | | | | | | | | | | | | | | | | | | | | | | | | | | | | | | | | | | | | | | | | | | | | | | | | | | | | | | | | | | | | | | | | | | | | | | | | | | | | | | | | | | | | | | | | | | | | | | | | | | | | | | | | | | | | | | | | | | | | | | | | | | | | | | | | | | | | | | | | | | | | | | | | | | | | | | | | | | | | | | | | | | | | | | | | | | | | | | | | | | | | | | | | | | | | | | | | | | | | | | | | | | | | | | | | | | | | | | | | | | | | | | | | | | | | | | | | | | | | | | | | | | | | | | | | | |
| 56,000 pF | 563 | J | K | M | HE | HG | HG | HJ | | | | JE | JE | JE | JL | | | KE | KF | KF | KF | | | | 62,000 pF | 623 | J | K | M | HG | HG | HG | HK | | | | JE | JE | JE | JL | | | KF | KF | KF | KH | | | | 68,000 pF | 683 | J | K | M | HG | HJ | HJ | HK | | | | JE | JK | JK | JL | | | KE | KF | KF | KJ | | | | 82,000 pF | 823 | J | K | M | HG | HJ | HJ | | | | | JE | JL | JL | JN | | | KE | KF | KF | KJ | | | | 0.10 µF | 104 | J | K | M | HG | HK | HK | | | | | JE | JN | JN | | | | KE | KH | KH | KJ | | | | 0.12 µF | 124 | J | K | M | HG | | | | | | | JE | JN | JN | | | | KE | KH | KH | KJ | | | | 0.15 µF | 154 | J | K | M | HG | | | | | | | JK | | | | | | KF | KJ | KJ | | | | | 0.18 µF | 184 | J | K | M | HG | | | | | | | JK | | | | | | KF | | | | | | | 0.22 µF | 224 | J | K | M | HG | | | | | | | | | | | | | KF | | | | | | | | | | | | | | | | | | | | | | | | | | | | | | | | | | | | | | | | | | | | | | | | | | | | | | | | | | | | | | | | | | | | | | | | | | | | | | | | | | | | | | | | | | | | | | | | | | | | | | | | | | | | | | | | | | | | | | | | | | | | | | | | | | | | | | | | | | | | | | | | | | | | | | | | | | | | | | | | | | | | | | | | | | | | | | | | | | | | | | | | | | | | | | | | | | | | | | | | | | | | | | | | | | | | | | | | | | | | | | | | | | | | | | | | | | | | | | | | | | | | | | | | | | | | | | | | | | | | | | | | | | | | | | | | | | | | | | | | | | | | | | | | | | | | | | | | | | | | | | | | | | | | | | | | | | | | | | | | | | | | | | | | | | | | | | | | | | | | | | | | | | | | | | | | | | | | | | | | | | | | | | | | | | | | | | | | | | | | | | | | | | | | | | | | | | | | | | | | | | | | | | | | | | | | | | | | | | | | | | | | | | | | | | | | | | | | | | | | | | | | | | | | | | | | | | | | | | | | | | | | | | | | | | | | | | | | | | | | | | | | | | | | | | | | | | | | | | | | | | | | | | | | | | | | | | | | | | | | | | | | | | | | | | | | | | | | | | | | | | | | | | | | | | | | | | | | | | | | | | | | | | | | | | | | | | | | | | | | | | | | | | | | | | | | | | | | | | | | | | | | | | | | | | | | | | | | | | | | | | | | | | | | | | | | | | | | | | | | | | | | | | | | | | | | | | | | |
| 62,000 pF | 623 | J | K | M | HG | HG | HG | HK | | | | JE | JE | JE | JL | | | KF | KF | KF | KH | | | | 68,000 pF | 683 | J | K | M | HG | HJ | HJ | HK | | | | JE | JK | JK | JL | | | KE | KF | KF | KJ | | | | 82,000 pF | 823 | J | K | M | HG | HJ | HJ | | | | | JE | JL | JL | JN | | | KE | KF | KF | KJ | | | | 0.10 µF | 104 | J | K | M | HG | HK | HK | | | | | JE | JN | JN | | | | KE | KH | KH | KJ | | | | 0.12 µF | 124 | J | K | M | HG | | | | | | | JE | JN | JN | | | | KE | KH | KH | KJ | | | | 0.15 µF | 154 | J | K | M | HG | | | | | | | JK | | | | | | KF | KJ | KJ | | | | | 0.18 µF | 184 | J | K | M | HG | | | | | | | JK | | | | | | KF | | | | | | | 0.22 µF | 224 | J | K | M | HG | | | | | | | | | | | | | KF | | | | | | | | | | | | | | | | | | | | | | | | | | | | | | | | | | | | | | | | | | | | | | | | | | | | | | | | | | | | | | | | | | | | | | | | | | | | | | | | | | | | | | | | | | | | | | | | | | | | | | | | | | | | | | | | | | | | | | | | | | | | | | | | | | | | | | | | | | | | | | | | | | | | | | | | | | | | | | | | | | | | | | | | | | | | | | | | | | | | | | | | | | | | | | | | | | | | | | | | | | | | | | | | | | | | | | | | | | | | | | | | | | | | | | | | | | | | | | | | | | | | | | | | | | | | | | | | | | | | | | | | | | | | | | | | | | | | | | | | | | | | | | | | | | | | | | | | | | | | | | | | | | | | | | | | | | | | | | | | | | | | | | | | | | | | | | | | | | | | | | | | | | | | | | | | | | | | | | | | | | | | | | | | | | | | | | | | | | | | | | | | | | | | | | | | | | | | | | | | | | | | | | | | | | | | | | | | | | | | | | | | | | | | | | | | | | | | | | | | | | | | | | | | | | | | | | | | | | | | | | | | | | | | | | | | | | | | | | | | | | | | | | | | | | | | | | | | | | | | | | | | | | | | | | | | | | | | | | | | | | | | | | | | | | | | | | | | | | | | | | | | | | | | | | | | | | | | | | | | | | | | | | | | | | | | | | | | | | | | | | | | | | | | | | | | | | | | | | | | | | | | | | | | | | | | | | | | | | | | | | | | | | | | | | | | | | | | | | | | | | | | | | | | | | | | | | | | | | | | | | | | | | | | | | | | | | | | | | | | | |
| 68,000 pF | 683 | J | K | M | HG | HJ | HJ | HK | | | | JE | JK | JK | JL | | | KE | KF | KF | KJ | | | | 82,000 pF | 823 | J | K | M | HG | HJ | HJ | | | | | JE | JL | JL | JN | | | KE | KF | KF | KJ | | | | 0.10 µF | 104 | J | K | M | HG | HK | HK | | | | | JE | JN | JN | | | | KE | KH | KH | KJ | | | | 0.12 µF | 124 | J | K | M | HG | | | | | | | JE | JN | JN | | | | KE | KH | KH | KJ | | | | 0.15 µF | 154 | J | K | M | HG | | | | | | | JK | | | | | | KF | KJ | KJ | | | | | 0.18 µF | 184 | J | K | M | HG | | | | | | | JK | | | | | | KF | | | | | | | 0.22 µF | 224 | J | K | M | HG | | | | | | | | | | | | | KF | | | | | | | | | | | | | | | | | | | | | | | | | | | | | | | | | | | | | | | | | | | | | | | | | | | | | | | | | | | | | | | | | | | | | | | | | | | | | | | | | | | | | | | | | | | | | | | | | | | | | | | | | | | | | | | | | | | | | | | | | | | | | | | | | | | | | | | | | | | | | | | | | | | | | | | | | | | | | | | | | | | | | | | | | | | | | | | | | | | | | | | | | | | | | | | | | | | | | | | | | | | | | | | | | | | | | | | | | | | | | | | | | | | | | | | | | | | | | | | | | | | | | | | | | | | | | | | | | | | | | | | | | | | | | | | | | | | | | | | | | | | | | | | | | | | | | | | | | | | | | | | | | | | | | | | | | | | | | | | | | | | | | | | | | | | | | | | | | | | | | | | | | | | | | | | | | | | | | | | | | | | | | | | | | | | | | | | | | | | | | | | | | | | | | | | | | | | | | | | | | | | | | | | | | | | | | | | | | | | | | | | | | | | | | | | | | | | | | | | | | | | | | | | | | | | | | | | | | | | | | | | | | | | | | | | | | | | | | | | | | | | | | | | | | | | | | | | | | | | | | | | | | | | | | | | | | | | | | | | | | | | | | | | | | | | | | | | | | | | | | | | | | | | | | | | | | | | | | | | | | | | | | | | | | | | | | | | | | | | | | | | | | | | | | | | | | | | | | | | | | | | | | | | | | | | | | | | | | | | | | | | | | | | | | | | | | | | | | | | | | | | | | | | | | | | | | | | | | | | | | | | | | | | | | | | | | | | | | | | | | | | | | | | | | | | | | | | | | | | | | | | | | | |
| 82,000 pF | 823 | J | K | M | HG | HJ | HJ | | | | | JE | JL | JL | JN | | | KE | KF | KF | KJ | | | | 0.10 µF | 104 | J | K | M | HG | HK | HK | | | | | JE | JN | JN | | | | KE | KH | KH | KJ | | | | 0.12 µF | 124 | J | K | M | HG | | | | | | | JE | JN | JN | | | | KE | KH | KH | KJ | | | | 0.15 µF | 154 | J | K | M | HG | | | | | | | JK | | | | | | KF | KJ | KJ | | | | | 0.18 µF | 184 | J | K | M | HG | | | | | | | JK | | | | | | KF | | | | | | | 0.22 µF | 224 | J | K | M | HG | | | | | | | | | | | | | KF | | | | | | | | | | | | | | | | | | | | | | | | | | | | | | | | | | | | | | | | | | | | | | | | | | | | | | | | | | | | | | | | | | | | | | | | | | | | | | | | | | | | | | | | | | | | | | | | | | | | | | | | | | | | | | | | | | | | | | | | | | | | | | | | | | | | | | | | | | | | | | | | | | | | | | | | | | | | | | | | | | | | | | | | | | | | | | | | | | | | | | | | | | | | | | | | | | | | | | | | | | | | | | | | | | | | | | | | | | | | | | | | | | | | | | | | | | | | | | | | | | | | | | | | | | | | | | | | | | | | | | | | | | | | | | | | | | | | | | | | | | | | | | | | | | | | | | | | | | | | | | | | | | | | | | | | | | | | | | | | | | | | | | | | | | | | | | | | | | | | | | | | | | | | | | | | | | | | | | | | | | | | | | | | | | | | | | | | | | | | | | | | | | | | | | | | | | | | | | | | | | | | | | | | | | | | | | | | | | | | | | | | | | | | | | | | | | | | | | | | | | | | | | | | | | | | | | | | | | | | | | | | | | | | | | | | | | | | | | | | | | | | | | | | | | | | | | | | | | | | | | | | | | | | | | | | | | | | | | | | | | | | | | | | | | | | | | | | | | | | | | | | | | | | | | | | | | | | | | | | | | | | | | | | | | | | | | | | | | | | | | | | | | | | | | | | | | | | | | | | | | | | | | | | | | | | | | | | | | | | | | | | | | | | | | | | | | | | | | | | | | | | | | | | | | | | | | | | | | | | | | | | | | | | | | | | | | | | | | | | | | | | | | | | | | | | | | | | | | | | | | | | | | | | | | | | | | | | | | | | | | | | | | | | | | | |
| 0.10 µF | 104 | J | K | M | HG | HK | HK | | | | | JE | JN | JN | | | | KE | KH | KH | KJ | | | | 0.12 µF | 124 | J | K | M | HG | | | | | | | JE | JN | JN | | | | KE | KH | KH | KJ | | | | 0.15 µF | 154 | J | K | M | HG | | | | | | | JK | | | | | | KF | KJ | KJ | | | | | 0.18 µF | 184 | J | K | M | HG | | | | | | | JK | | | | | | KF | | | | | | | 0.22 µF | 224 | J | K | M | HG | | | | | | | | | | | | | KF | | | | | | | | | | | | | | | | | | | | | | | | | | | | | | | | | | | | | | | | | | | | | | | | | | | | | | | | | | | | | | | | | | | | | | | | | | | | | | | | | | | | | | | | | | | | | | | | | | | | | | | | | | | | | | | | | | | | | | | | | | | | | | | | | | | | | | | | | | | | | | | | | | | | | | | | | | | | | | | | | | | | | | | | | | | | | | | | | | | | | | | | | | | | | | | | | | | | | | | | | | | | | | | | | | | | | | | | | | | | | | | | | | | | | | | | | | | | | | | | | | | | | | | | | | | | | | | | | | | | | | | | | | | | | | | | | | | | | | | | | | | | | | | | | | | | | | | | | | | | | | | | | | | | | | | | | | | | | | | | | | | | | | | | | | | | | | | | | | | | | | | | | | | | | | | | | | | | | | | | | | | | | | | | | | | | | | | | | | | | | | | | | | | | | | | | | | | | | | | | | | | | | | | | | | | | | | | | | | | | | | | | | | | | | | | | | | | | | | | | | | | | | | | | | | | | | | | | | | | | | | | | | | | | | | | | | | | | | | | | | | | | | | | | | | | | | | | | | | | | | | | | | | | | | | | | | | | | | | | | | | | | | | | | | | | | | | | | | | | | | | | | | | | | | | | | | | | | | | | | | | | | | | | | | | | | | | | | | | | | | | | | | | | | | | | | | | | | | | | | | | | | | | | | | | | | | | | | | | | | | | | | | | | | | | | | | | | | | | | | | | | | | | | | | | | | | | | | | | | | | | | | | | | | | | | | | | | | | | | | | | | | | | | | | | | | | | | | | | | | | | | | | | | | | | | | | | | | | | | | | | | | | | | | | | | | | | | | | | | | | | | | | | | | | | | | | | | | |
| 0.12 µF | 124 | J | K | M | HG | | | | | | | JE | JN | JN | | | | KE | KH | KH | KJ | | | | 0.15 µF | 154 | J | K | M | HG | | | | | | | JK | | | | | | KF | KJ | KJ | | | | | 0.18 µF | 184 | J | K | M | HG | | | | | | | JK | | | | | | KF | | | | | | | 0.22 µF | 224 | J | K | M | HG | | | | | | | | | | | | | KF | | | | | | | | | | | | | | | | | | | | | | | | | | | | | | | | | | | | | | | | | | | | | | | | | | | | | | | | | | | | | | | | | | | | | | | | | | | | | | | | | | | | | | | | | | | | | | | | | | | | | | | | | | | | | | | | | | | | | | | | | | | | | | | | | | | | | | | | | | | | | | | | | | | | | | | | | | | | | | | | | | | | | | | | | | | | | | | | | | | | | | | | | | | | | | | | | | | | | | | | | | | | | | | | | | | | | | | | | | | | | | | | | | | | | | | | | | | | | | | | | | | | | | | | | | | | | | | | | | | | | | | | | | | | | | | | | | | | | | | | | | | | | | | | | | | | | | | | | | | | | | | | | | | | | | | | | | | | | | | | | | | | | | | | | | | | | | | | | | | | | | | | | | | | | | | | | | | | | | | | | | | | | | | | | | | | | | | | | | | | | | | | | | | | | | | | | | | | | | | | | | | | | | | | | | | | | | | | | | | | | | | | | | | | | | | | | | | | | | | | | | | | | | | | | | | | | | | | | | | | | | | | | | | | | | | | | | | | | | | | | | | | | | | | | | | | | | | | | | | | | | | | | | | | | | | | | | | | | | | | | | | | | | | | | | | | | | | | | | | | | | | | | | | | | | | | | | | | | | | | | | | | | | | | | | | | | | | | | | | | | | | | | | | | | | | | | | | | | | | | | | | | | | | | | | | | | | | | | | | | | | | | | | | | | | | | | | | | | | | | | | | | | | | | | | | | | | | | | | | | | | | | | | | | | | | | | | | | | | | | | | | | | | | | | | | | | | | | | | | | | | | | | | | | | | | | | | | | | | | | | | | | | | | | | | | | | | | | | | | | | | | | | | | | | | | | | | | | | | | | | | | | | | | | | | | | | | | | | | | | | |
| 0.15 µF | 154 | J | K | M | HG | | | | | | | JK | | | | | | KF | KJ | KJ | | | | | 0.18 µF | 184 | J | K | M | HG | | | | | | | JK | | | | | | KF | | | | | | | 0.22 µF | 224 | J | K | M | HG | | | | | | | | | | | | | KF | | | | | | | | | | | | | | | | | | | | | | | | | | | | | | | | | | | | | | | | | | | | | | | | | | | | | | | | | | | | | | | | | | | | | | | | | | | | | | | | | | | | | | | | | | | | | | | | | | | | | | | | | | | | | | | | | | | | | | | | | | | | | | | | | | | | | | | | | | | | | | | | | | | | | | | | | | | | | | | | | | | | | | | | | | | | | | | | | | | | | | | | | | | | | | | | | | | | | | | | | | | | | | | | | | | | | | | | | | | | | | | | | | | | | | | | | | | | | | | | | | | | | | | | | | | | | | | | | | | | | | | | | | | | | | | | | | | | | | | | | | | | | | | | | | | | | | | | | | | | | | | | | | | | | | | | | | | | | | | | | | | | | | | | | | | | | | | | | | | | | | | | | | | | | | | | | | | | | | | | | | | | | | | | | | | | | | | | | | | | | | | | | | | | | | | | | | | | | | | | | | | | | | | | | | | | | | | | | | | | | | | | | | | | | | | | | | | | | | | | | | | | | | | | | | | | | | | | | | | | | | | | | | | | | | | | | | | | | | | | | | | | | | | | | | | | | | | | | | | | | | | | | | | | | | | | | | | | | | | | | | | | | | | | | | | | | | | | | | | | | | | | | | | | | | | | | | | | | | | | | | | | | | | | | | | | | | | | | | | | | | | | | | | | | | | | | | | | | | | | | | | | | | | | | | | | | | | | | | | | | | | | | | | | | | | | | | | | | | | | | | | | | | | | | | | | | | | | | | | | | | | | | | | | | | | | | | | | | | | | | | | | | | | | | | | | | | | | | | | | | | | | | | | | | | | | | | | | | | | | | | | | | | | | | | | | | | | | | | | | | | | | | | | | | | | | | | | | | | | | | | | | | | | | | | | | | | | | | | | | | | | | | | | | | | | | | | | | | | | | | | | | | | |
| 0.18 µF | 184 | J | K | M | HG | | | | | | | JK | | | | | | KF | | | | | | | 0.22 µF | 224 | J | K | M | HG | | | | | | | | | | | | | KF | | | | | | | | | | | | | | | | | | | | | | | | | | | | | | | | | | | | | | | | | | | | | | | | | | | | | | | | | | | | | | | | | | | | | | | | | | | | | | | | | | | | | | | | | | | | | | | | | | | | | | | | | | | | | | | | | | | | | | | | | | | | | | | | | | | | | | | | | | | | | | | | | | | | | | | | | | | | | | | | | | | | | | | | | | | | | | | | | | | | | | | | | | | | | | | | | | | | | | | | | | | | | | | | | | | | | | | | | | | | | | | | | | | | | | | | | | | | | | | | | | | | | | | | | | | | | | | | | | | | | | | | | | | | | | | | | | | | | | | | | | | | | | | | | | | | | | | | | | | | | | | | | | | | | | | | | | | | | | | | | | | | | | | | | | | | | | | | | | | | | | | | | | | | | | | | | | | | | | | | | | | | | | | | | | | | | | | | | | | | | | | | | | | | | | | | | | | | | | | | | | | | | | | | | | | | | | | | | | | | | | | | | | | | | | | | | | | | | | | | | | | | | | | | | | | | | | | | | | | | | | | | | | | | | | | | | | | | | | | | | | | | | | | | | | | | | | | | | | | | | | | | | | | | | | | | | | | | | | | | | | | | | | | | | | | | | | | | | | | | | | | | | | | | | | | | | | | | | | | | | | | | | | | | | | | | | | | | | | | | | | | | | | | | | | | | | | | | | | | | | | | | | | | | | | | | | | | | | | | | | | | | | | | | | | | | | | | | | | | | | | | | | | | | | | | | | | | | | | | | | | | | | | | | | | | | | | | | | | | | | | | | | | | | | | | | | | | | | | | | | | | | | | | | | | | | | | | | | | | | | | | | | | | | | | | | | | | | | | | | | | | | | | | | | | | | | | | | | | | | | | | | | | | | | | | | | | | | | | | | | | | | | | | | | | | | | | | | | | | | | | | | | | | | | | | | | | | | | | | | | | | | | | | | | | | |
| 0.22 µF | 224 | J | K | M | HG | | | | | | | | | | | | | KF | | | | | | | | | | | | | | | | | | | | | | | | | | | | | | | | | | | | | | | | | | | | | | | | | | | | | | | | | | | | | | | | | | | | | | | | | | | | | | | | | | | | | | | | | | | | | | | | | | | | | | | | | | | | | | | | | | | | | | | | | | | | | | | | | | | | | | | | | | | | | | | | | | | | | | | | | | | | | | | | | | | | | | | | | | | | | | | | | | | | | | | | | | | | | | | | | | | | | | | | | | | | | | | | | | | | | | | | | | | | | | | | | | | | | | | | | | | | | | | | | | | | | | | | | | | | | | | | | | | | | | | | | | | | | | | | | | | | | | | | | | | | | | | | | | | | | | | | | | | | | | | | | | | | | | | | | | | | | | | | | | | | | | | | | | | | | | | | | | | | | | | | | | | | | | | | | | | | | | | | | | | | | | | | | | | | | | | | | | | | | | | | | | | | | | | | | | | | | | | | | | | | | | | | | | | | | | | | | | | | | | | | | | | | | | | | | | | | | | | | | | | | | | | | | | | | | | | | | | | | | | | | | | | | | | | | | | | | | | | | | | | | | | | | | | | | | | | | | | | | | | | | | | | | | | | | | | | | | | | | | | | | | | | | | | | | | | | | | | | | | | | | | | | | | | | | | | | | | | | | | | | | | | | | | | | | | | | | | | | | | | | | | | | | | | | | | | | | | | | | | | | | | | | | | | | | | | | | | | | | | | | | | | | | | | | | | | | | | | | | | | | | | | | | | | | | | | | | | | | | | | | | | | | | | | | | | | | | | | | | | | | | | | | | | | | | | | | | | | | | | | | | | | | | | | | | | | | | | | | | | | | | | | | | | | | | | | | | | | | | | | | | | | | | | | | | | | | | | | | | | | | | | | | | | | | | | | | | | | | | | | | | | | | | | | | | | | | | | | | | | | | | | | | | | | | | | | | | | | | | | | | | | | | | | | | | | | | | | | | | | | | | | | | | | | | | | | | | |

KEMET reserves the right to substitute product with an improved temperature characteristic, tighter capacitance tolerance and/or higher voltage capability within the same form factor (configuration and dimensions).

Table 2 – Chip Thickness/Packaging Quantities

| Thickness Code | Case Size | Thickness ± Range (mm) | Paper Quantity | | Plastic Quantity | |
|----------------|-----------|------------------------|----------------|----------|------------------|----------|
| | | | 7" Reel | 13" Reel | 7" Reel | 13" Reel |
| DG | 0805 | 1.25 ± 0.15 | 0 | 0 | 2,500 | 10,000 |
| EF | 1206 | 1.20 ± 0.15 | 0 | 0 | 2,500 | 10,000 |
| EG | 1206 | 1.60 ± 0.15 | 0 | 0 | 2,000 | 8,000 |
| EJ | 1206 | 1.70 ± 0.20 | 0 | 0 | 2,000 | 8,000 |
| FG | 1210 | 1.25 ± 0.15 | 0 | 0 | 2,500 | 10,000 |
| FL | 1210 | 1.40 ± 0.15 | 0 | 0 | 2,000 | 8,000 |
| FH | 1210 | 1.55 ± 0.15 | 0 | 0 | 2,000 | 8,000 |
| FM | 1210 | 1.70 ± 0.20 | 0 | 0 | 2,000 | 8,000 |
| FK | 1210 | 2.10 ± 0.20 | 0 | 0 | 2,000 | 8,000 |
| FS | 1210 | 2.50 ± 0.30 | 0 | 0 | 1,000 | 4,000 |
| LE | 1808 | 1.00 ± 0.10 | 0 | 0 | 2,500 | 10,000 |
| LA | 1808 | 1.40 ± 0.15 | 0 | 0 | 1,000 | 4,000 |
| LB | 1808 | 1.60 ± 0.15 | 0 | 0 | 1,000 | 4,000 |
| LC | 1808 | 2.00 ± 0.15 | 0 | 0 | 1,000 | 4,000 |
| GB | 1812 | 1.00 ± 0.10 | 0 | 0 | 1,000 | 4,000 |
| GC | 1812 | 1.10 ± 0.10 | 0 | 0 | 1,000 | 4,000 |
| GE | 1812 | 1.30 ± 0.10 | 0 | 0 | 1,000 | 4,000 |
| GG | 1812 | 1.55 ± 0.10 | 0 | 0 | 1,000 | 4,000 |
| GH | 1812 | 1.40 ± 0.15 | 0 | 0 | 1,000 | 4,000 |
| GF | 1812 | 1.50 ± 0.10 | 0 | 0 | 1,000 | 4,000 |
| GK | 1812 | 1.60 ± 0.20 | 0 | 0 | 1,000 | 4,000 |
| GJ | 1812 | 1.70 ± 0.15 | 0 | 0 | 1,000 | 4,000 |
| GN | 1812 | 1.70 ± 0.20 | 0 | 0 | 1,000 | 4,000 |
| GL | 1812 | 1.90 ± 0.20 | 0 | 0 | 500 | 2,000 |
| GM | 1812 | 2.00 ± 0.20 | 0 | 0 | 500 | 2,000 |
| GS | 1812 | 2.10 ± 0.20 | 0 | 0 | 500 | 2,000 |
| GO | 1812 | 2.50 ± 0.20 | 0 | 0 | 500 | 2,000 |
| HE | 1825 | 1.40 ± 0.15 | 0 | 0 | 1,000 | 4,000 |
| HG | 1825 | 1.60 ± 0.20 | 0 | 0 | 1,000 | 4,000 |
| HJ | 1825 | 2.00 ± 0.20 | 0 | 0 | 500 | 2,000 |
| HK | 1825 | 2.50 ± 0.20 | 0 | 0 | 500 | 2,000 |
| JE | 2220 | 1.40 ± 0.15 | 0 | 0 | 1,000 | 4,000 |
| JK | 2220 | 1.60 ± 0.20 | 0 | 0 | 500 | 2,000 |
| JL | 2220 | 2.00 ± 0.20 | 0 | 0 | 500 | 2,000 |
| JN | 2220 | 2.50 ± 0.20 | 0 | 0 | 500 | 2,000 |
| KE | 2225 | 1.40 ± 0.15 | 0 | 0 | 1,000 | 4,000 |
| KF | 2225 | 1.60 ± 0.20 | 0 | 0 | 1,000 | 4,000 |
| KH | 2225 | 2.00 ± 0.20 | 0 | 0 | 500 | 2,000 |
| KJ | 2225 | 2.50 ± 0.20 | 0 | 0 | 500 | 2,000 |
| Thickness Code | Case Size | Thickness ± Range (mm) | 7" Reel | 13" Reel | 7" Reel | 13" Reel |
| | | | Paper Quantity | | Plastic Quantity | |

Package quantity based on finished chip thickness specifications.

Table 3 – Chip Capacitor Land Pattern Design Recommendations per IPC–7351

| EIA Size Code | Metric Size Code | Density Level A: Maximum (Most) Land Protrusion (mm) | | | | | Density Level B: Median (Nominal) Land Protrusion (mm) | | | | | Density Level C: Minimum (Least) Land Protrusion (mm) | | | | |
|---------------|------------------|--|------|------|------|------|--|------|------|------|------|---|------|------|------|------|
| | | C | Y | X | V1 | V2 | C | Y | X | V1 | V2 | C | Y | X | V1 | V2 |
| 0805 | 2012 | 1.00 | 1.35 | 1.55 | 4.40 | 2.60 | 0.90 | 1.15 | 1.45 | 3.50 | 2.00 | 0.75 | 0.95 | 1.35 | 2.80 | 1.70 |
| 1206 | 3216 | 1.60 | 1.65 | 1.90 | 5.90 | 2.90 | 1.50 | 1.45 | 1.80 | 5.00 | 2.30 | 1.40 | 1.25 | 1.70 | 4.30 | 2.00 |
| 1210 | 3225 | 1.60 | 1.65 | 2.80 | 5.90 | 3.80 | 1.50 | 1.45 | 2.70 | 5.00 | 3.20 | 1.40 | 1.25 | 2.60 | 4.30 | 2.90 |
| 1808 | 4520 | 2.30 | 1.75 | 2.30 | 7.40 | 3.30 | 2.20 | 1.55 | 2.20 | 6.50 | 2.70 | 2.10 | 1.35 | 2.10 | 5.80 | 2.40 |
| 1812 | 4532 | 2.10 | 1.80 | 3.60 | 7.00 | 4.60 | 2.00 | 1.60 | 3.50 | 6.10 | 4.00 | 1.90 | 1.40 | 3.40 | 5.40 | 3.70 |
| 1825 | 4564 | 2.15 | 1.80 | 6.90 | 7.10 | 7.90 | 2.05 | 1.60 | 6.80 | 6.20 | 7.30 | 1.95 | 1.40 | 6.70 | 5.50 | 7.00 |
| 2220 | 5650 | 2.85 | 2.10 | 5.50 | 8.80 | 6.50 | 2.75 | 1.90 | 5.40 | 7.90 | 5.90 | 2.65 | 1.70 | 5.30 | 7.20 | 5.60 |
| 2225 | 5664 | 2.85 | 2.10 | 6.90 | 8.80 | 7.90 | 2.75 | 1.90 | 6.80 | 7.90 | 7.30 | 2.65 | 1.70 | 6.70 | 7.20 | 7.00 |

Density Level A: For low-density product applications. Recommended for wave solder applications and provides a wider process window for reflow solder processes. KEMET only recommends wave soldering of EIA 0603, 0805 and 1206 case sizes.

Density Level B: For products with a moderate level of component density. Provides a robust solder attachment condition for reflow solder processes.

Density Level C: For high component density product applications. Before adapting the minimum land pattern variations the user should perform qualification testing based on the conditions outlined in IPC Standard 7351 (IPC–7351).

Image below based on Density Level B for an EIA 1210 case size.

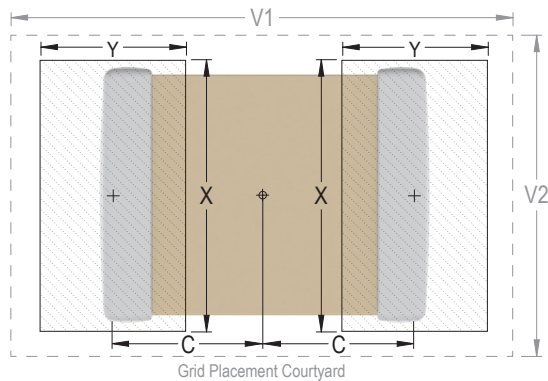

Soldering Process

Recommended Soldering Technique:

- Solder wave or solder reflow for EIA case sizes 0603, 0805 and 1206
- All other EIA case sizes are limited to solder reflow only

Recommended Reflow Soldering Profile:

KEMET's families of surface mount multilayer ceramic capacitors (SMD MLCCs) are compatible with wave (single or dual), convection, IR or vapor phase reflow techniques. Preheating of these components is recommended to avoid extreme thermal stress. KEMET's recommended profile conditions for convection and IR reflow reflect the profile conditions of the IPC/J-STD-020 standard for moisture sensitivity testing. These devices can safely withstand a maximum of three reflow passes at these conditions.

| Profile Feature | Termination Finish | |
|---|--------------------|--------------------|
| | SnPb | 100% Matte Sn |
| Preheat/Soak | | |
| Temperature Minimum (T_{Smin}) | 100°C | 150°C |
| Temperature Maximum (T_{Smax}) | 150°C | 200°C |
| Time (t_s) from T_{Smin} to T_{Smax} | 60 – 120 seconds | 60 – 120 seconds |
| Ramp-Up Rate (T_L to T_p) | 3°C/second maximum | 3°C/second maximum |
| Liquidous Temperature (T_L) | 183°C | 217°C |
| Time Above Liquidous (t_L) | 60 – 150 seconds | 60 – 150 seconds |
| Peak Temperature (T_p) | 235°C | 260°C |
| Time Within 5°C of Maximum Peak Temperature (t_p) | 20 seconds maximum | 30 seconds maximum |
| Ramp-Down Rate (T_p to T_L) | 6°C/second maximum | 6°C/second maximum |
| Time 25°C to Peak Temperature | 6 minutes maximum | 8 minutes maximum |

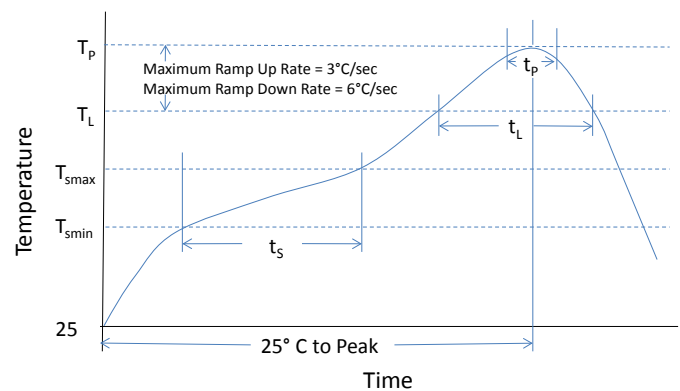

Note 1: All temperatures refer to the center of the package, measured on the capacitor body surface that is facing up during assembly reflow.

Table 4 – Performance & Reliability: Test Methods and Conditions

| Stress | Reference | Test or Inspection Method |
|------------------------|------------------------|---|
| Terminal Strength | JIS-C-6429 | Appendix 1, Note: Force of 1.8 kg for 60 seconds. |
| Board Flex | JIS-C-6429 | Appendix 2, Note: Standard termination system – 2.0 mm (minimum) for all except 3 mm for C0G. Flexible termination system – 3.0 mm (minimum). |
| Solderability | J-STD-002 | Magnification 50 X. Conditions: |
| | | a) Method B, 4 hours @ 155°C, dry heat @ 235°C |
| | | b) Method B @ 215°C category 3 |
| | | c) Method D, category 3 @ 260°C |
| Temperature Cycling | JESD22 Method JA-104 | 1,000 cycles (-55°C to +125°C). Measurement at 24 hours +/- 2 hours after test conclusion. |
| Biased Humidity | MIL-STD-202 Method 103 | Load Humidity: 1,000 hours 85°C/85% RH and 200 VDC maximum. Add 100 K ohm resistor. Measurement at 24 hours +/- 2 hours after test conclusion. |
| | | Low Volt Humidity: 1,000 hours 85°C/85% RH and 1.5 V. Add 100 K ohm resistor. Measurement at 24 hours +/- 2 hours after test conclusion. |
| Moisture Resistance | MIL-STD-202 Method 106 | t = 24 hours/cycle. Steps 7a and 7b not required. Unpowered. Measurement at 24 hours +/- 2 hours after test conclusion. |
| Thermal Shock | MIL-STD-202 Method 107 | -55°C/+125°C. Note: Number of cycles required – 300. Maximum transfer time – 20 seconds. Dwell time – 15 minutes. Air – Air. |
| High Temperature Life | MIL-STD-202 Method 108 | 1,000 hours at 125°C (85°C for X5R, Z5U and Y5V) with 1.2 X rated voltage applied. |
| Storage Life | MIL-STD-202 Method 108 | 150°C, 0 VDC for 1,000 hours. |
| Vibration | MIL-STD-202 Method 204 | 5 g's for 20 min., 12 cycles each of 3 orientations. Note: Use 8" X 5" PCB 0.031" thick 7 secure points on one long side and 2 secure points at corners of opposite sides. Parts mounted within 2" from any secure point. Test from 10 – 2,000 Hz |
| Mechanical Shock | MIL-STD-202 Method 213 | Figure 1 of Method 213, Condition F. |
| Resistance to Solvents | MIL-STD-202 Method 215 | Add aqueous wash chemical, OKEM Clean or equivalent. |

Storage and Handling

Ceramic chip capacitors should be stored in normal working environments. While the chips themselves are quite robust in other environments, solderability will be degraded by exposure to high temperatures, high humidity, corrosive atmospheres, and long term storage. In addition, packaging materials will be degraded by high temperature– reels may soften or warp and tape peel force may increase. KEMET recommends that maximum storage temperature not exceed 40°C and maximum storage humidity not exceed 70% relative humidity. Temperature fluctuations should be minimized to avoid condensation on the parts and atmospheres should be free of chlorine and sulfur bearing compounds. For optimized solderability chip stock should be used promptly, preferably within 1.5 years of receipt.

Construction

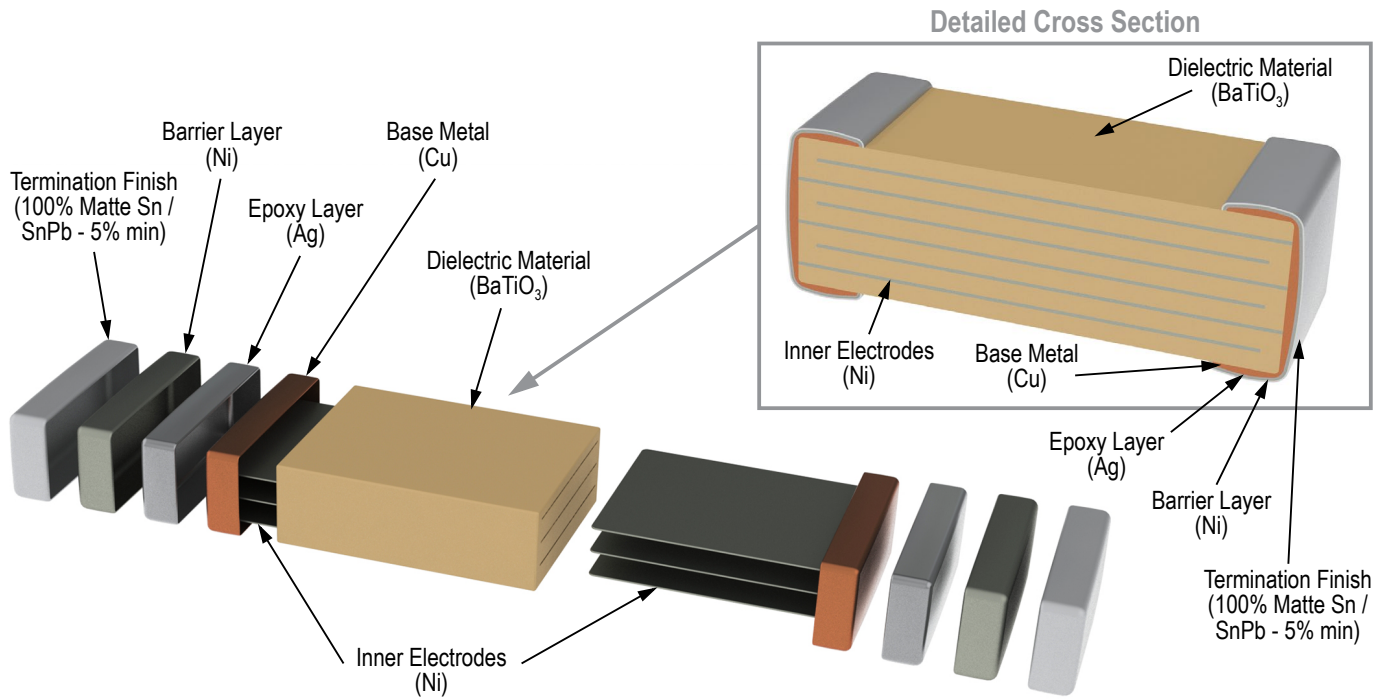

Capacitor Marking (Optional):

These surface mount multilayer ceramic capacitors are normally supplied unmarked. If required, they can be marked as an extra cost option. Marking is available on most KEMET devices but must be requested using the correct ordering code identifier(s). If this option is requested, two sides of the ceramic body will be laser marked with a “K” to identify KEMET, followed by two characters (per EIA–198 - see table below) to identify the capacitance value. EIA 0603 case size devices are limited to the “K” character only.

Laser marking option is not available on:

- COG, Ultra Stable X8R and Y5V dielectric devices
- EIA 0402 case size devices
- EIA 0603 case size devices with Flexible Termination option.
- KPS Commercial and Automotive Grade stacked devices.
- X7R dielectric products in capacitance values outlined below

| EIA Case Size | Metric Size Code | Capacitance |
|---------------|------------------|-------------|
| 0603 | 1608 | ≤ 170 pF |
| 0805 | 2012 | ≤ 150 pF |
| 1206 | 3216 | ≤ 910 pF |
| 1210 | 3225 | ≤ 2,000 pF |
| 1808 | 4520 | ≤ 3,900 pF |
| 1812 | 4532 | ≤ 6,700 pF |
| 1825 | 4564 | ≤ 0.018 μF |
| 2220 | 5650 | ≤ 0.027 μF |
| 2225 | 5664 | ≤ 0.033 μF |

Marking appears in legible contrast. Illustrated below is an example of an MLCC with laser marking of “KA8”, which designates a KEMET device with rated capacitance of 100 μF. Orientation of marking is vendor optional.

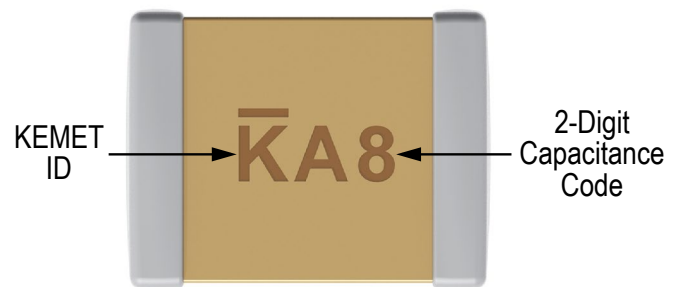

Capacitor Marking (Optional) cont'd

| Capacitance (pF) For Various Alpha/Numeral Identifiers | | | | | | | | | | |
|--|------------------|-----|----|-----|-------|--------|---------|-----------|------------|-------------|
| Alpha Character | Numeral | | | | | | | | | |
| | 9 | 0 | 1 | 2 | 3 | 4 | 5 | 6 | 7 | 8 |
| | Capacitance (pF) | | | | | | | | | |
| A | 0.1 | 10 | 10 | 100 | 1,000 | 10,000 | 100,000 | 1,000,000 | 10,000,000 | 100,000,000 |
| B | 0.11 | 1.1 | 11 | 110 | 1,100 | 11,000 | 110,000 | 1,100,000 | 11,000,000 | 110,000,000 |
| C | 0.12 | 1.2 | 12 | 120 | 1,200 | 12,000 | 120,000 | 1,200,000 | 12,000,000 | 120,000,000 |
| D | 0.13 | 1.3 | 13 | 130 | 1,300 | 13,000 | 130,000 | 1,300,000 | 13,000,000 | 130,000,000 |
| E | 0.15 | 1.5 | 15 | 150 | 1,500 | 15,000 | 150,000 | 1,500,000 | 15,000,000 | 150,000,000 |
| F | 0.16 | 1.6 | 16 | 160 | 1,600 | 16,000 | 160,000 | 1,600,000 | 16,000,000 | 160,000,000 |
| G | 0.18 | 1.8 | 18 | 180 | 1,800 | 18,000 | 180,000 | 1,800,000 | 18,000,000 | 180,000,000 |
| H | 0.2 | 20 | 20 | 200 | 2,000 | 20,000 | 200,000 | 2,000,000 | 20,000,000 | 200,000,000 |
| J | 0.22 | 2.2 | 22 | 220 | 2,200 | 22,000 | 220,000 | 2,200,000 | 22,000,000 | 220,000,000 |
| K | 0.24 | 2.4 | 24 | 240 | 2,400 | 24,000 | 240,000 | 2,400,000 | 24,000,000 | 240,000,000 |
| L | 0.27 | 2.7 | 27 | 270 | 2,700 | 27,000 | 270,000 | 2,700,000 | 27,000,000 | 270,000,000 |
| M | 0.3 | 30 | 30 | 300 | 3,000 | 30,000 | 300,000 | 3,000,000 | 30,000,000 | 300,000,000 |
| N | 0.33 | 3.3 | 33 | 330 | 3,300 | 33,000 | 330,000 | 3,300,000 | 33,000,000 | 330,000,000 |
| P | 0.36 | 3.6 | 36 | 360 | 3,600 | 36,000 | 360,000 | 3,600,000 | 36,000,000 | 360,000,000 |
| Q | 0.39 | 3.9 | 39 | 390 | 3,900 | 39,000 | 390,000 | 3,900,000 | 39,000,000 | 390,000,000 |
| R | 0.43 | 4.3 | 43 | 430 | 4,300 | 43,000 | 430,000 | 4,300,000 | 43,000,000 | 430,000,000 |
| S | 0.47 | 4.7 | 47 | 470 | 4,700 | 47,000 | 470,000 | 4,700,000 | 47,000,000 | 470,000,000 |
| T | 0.51 | 5.1 | 51 | 510 | 5,100 | 51,000 | 510,000 | 5,100,000 | 51,000,000 | 510,000,000 |
| U | 0.56 | 5.6 | 56 | 560 | 5,600 | 56,000 | 560,000 | 5,600,000 | 56,000,000 | 560,000,000 |
| V | 0.62 | 6.2 | 62 | 620 | 6,200 | 62,000 | 620,000 | 6,200,000 | 62,000,000 | 620,000,000 |
| W | 0.68 | 6.8 | 68 | 680 | 6,800 | 68,000 | 680,000 | 6,800,000 | 68,000,000 | 680,000,000 |
| X | 0.75 | 7.5 | 75 | 750 | 7,500 | 75,000 | 750,000 | 7,500,000 | 75,000,000 | 750,000,000 |
| Y | 0.82 | 8.2 | 82 | 820 | 8,200 | 82,000 | 820,000 | 8,200,000 | 82,000,000 | 820,000,000 |
| Z | 0.91 | 9.1 | 91 | 910 | 9,100 | 91,000 | 910,000 | 9,100,000 | 91,000,000 | 910,000,000 |
| a | 0.25 | 2.5 | 25 | 250 | 2,500 | 25,000 | 250,000 | 2,500,000 | 25,000,000 | 250,000,000 |
| b | 0.35 | 3.5 | 35 | 350 | 3,500 | 35,000 | 350,000 | 3,500,000 | 35,000,000 | 350,000,000 |
| d | 0.4 | 40 | 40 | 400 | 4,000 | 40,000 | 400,000 | 4,000,000 | 40,000,000 | 400,000,000 |
| e | 0.45 | 4.5 | 45 | 450 | 4,500 | 45,000 | 450,000 | 4,500,000 | 45,000,000 | 450,000,000 |
| f | 0.5 | 50 | 50 | 500 | 5,000 | 50,000 | 500,000 | 5,000,000 | 50,000,000 | 500,000,000 |
| m | 0.6 | 60 | 60 | 600 | 6,000 | 60,000 | 600,000 | 6,000,000 | 60,000,000 | 600,000,000 |
| n | 0.7 | 70 | 70 | 700 | 7,000 | 70,000 | 700,000 | 7,000,000 | 70,000,000 | 700,000,000 |
| t | 0.8 | 80 | 80 | 800 | 8,000 | 80,000 | 800,000 | 8,000,000 | 80,000,000 | 800,000,000 |
| y | 0.9 | 90 | 90 | 900 | 9,000 | 90,000 | 900,000 | 9,000,000 | 90,000,000 | 900,000,000 |

Figure 1 – Embossed (Plastic) Carrier Tape Dimensions

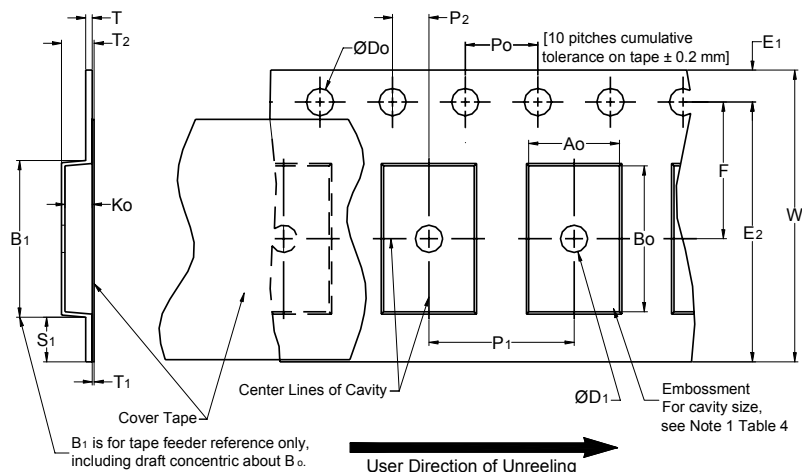

Table 6 – Embossed (Plastic) Carrier Tape Dimensions

Metric will govern

| Constant Dimensions — Millimeters (Inches) | | | | | | | | | |
|--|---------------------------------------|----------------------------------|------------------------------|-----------------------------|------------------------------|---------------------------|----------------------------------|--|---------------------------|
| Tape Size | D ₀ | D ₁ Minimum Note 1 | E ₁ | P ₀ | P ₂ | R Reference Note 2 | S ₁ Minimum Note 3 | T Maximum | T ₁ Maximum |
| 8 mm | 1.5 +0.10/-0.0 (0.059 +0.004/-0.0) | 1.0 (0.039) | 1.75 ±0.10 (0.069 ±0.004) | 4.0 ±0.10 (0.157 ±0.004) | 2.0 ±0.05 (0.079 ±0.002) | 25.0 (0.984) | 0.600 (0.024) | 0.600 (0.024) | 0.100 (0.004) |
| 12 mm | | 1.5 (0.059) | | | | 30 (1.181) | | | |
| 16 mm | | | | | | | | | |
| Variable Dimensions — Millimeters (Inches) | | | | | | | | | |
| Tape Size | Pitch | B ₁ Maximum Note 4 | E ₂ Minimum | F | P ₁ | T ₂ Maximum | W Maximum | A ₀ , B ₀ & K ₀ | |
| 8 mm | Single (4 mm) | 4.35 (0.171) | 6.25 (0.246) | 3.5 ±0.05 (0.138 ±0.002) | 4.0 ±0.10 (0.157 ±0.004) | 2.5 (0.098) | 8.3 (0.327) | Note 5 | |
| 12 mm | Single (4 mm) & Double (8 mm) | 8.2 (0.323) | 10.25 (0.404) | 5.5 ±0.05 (0.217 ±0.002) | 8.0 ±0.10 (0.315 ±0.004) | 4.6 (0.181) | 12.3 (0.484) | | |
| 16 mm | Triple (12 mm) | 12.1 (0.476) | 14.25 (0.561) | 7.5 ±0.05 (0.138 ±0.002) | 12.0 ±0.10 (0.157 ±0.004) | 4.6 (0.181) | 16.3 (0.642) | | |

- The embossment hole location shall be measured from the sprocket hole controlling the location of the embossment. Dimensions of embossment location and hole location shall be applied independent of each other.
- The tape with or without components shall pass around R without damage (see Figure 6).
- If S₁ < 1.0 mm, there may not be enough area for cover tape to be properly applied (see EIA Standard 481 paragraph 4.3 section b).
- B₁ dimension is a reference dimension for tape feeder clearance only.
- The cavity defined by A₀, B₀ and K₀ shall surround the component with sufficient clearance that:
 - the component does not protrude above the top surface of the carrier tape.
 - the component can be removed from the cavity in a vertical direction without mechanical restriction, after the top cover tape has been removed.
 - rotation of the component is limited to 20° maximum for 8 and 12 mm tapes and 10° maximum for 16 mm tapes (see Figure 3).
 - lateral movement of the component is restricted to 0.5 mm maximum for 8 and 12 mm wide tape and to 1.0 mm maximum for 16 mm tape (see Figure 4).
 - for KPS Series product, A₀ and B₀ are measured on a plane 0.3 mm above the bottom of the pocket.
 - see Addendum in EIA Standard 481 for standards relating to more precise taping requirements.

Figure 2 – Punched (Paper) Carrier Tape Dimensions

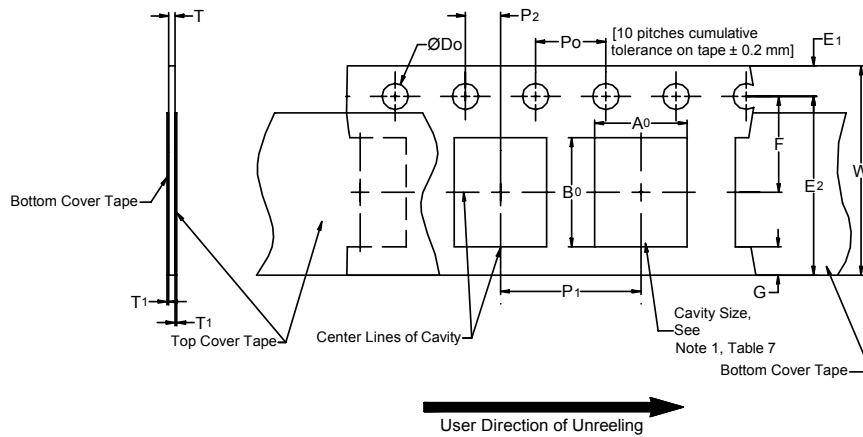

Table 7 – Punched (Paper) Carrier Tape Dimensions

Metric will govern

| Constant Dimensions — Millimeters (Inches) | | | | | | | |
|--|---|-----------------------------------|----------------------------------|----------------------------------|-------------------------|-----------------|--------------------|
| Tape Size | D_0 | E_1 | P_0 | P_2 | T_1 Maximum | G Minimum | R Reference Note 2 |
| 8 mm | $1.5 +0.10 -0.0$ (0.059 +0.004 -0.0) | 1.75 ± 0.10 (0.069 ±0.004) | 4.0 ± 0.10 (0.157 ±0.004) | 2.0 ± 0.05 (0.079 ±0.002) | 0.10 (0.004) Maximum | 0.75 (0.030) | 25 (0.984) |
| Variable Dimensions — Millimeters (Inches) | | | | | | | |
| Tape Size | Pitch | E2 Minimum | F | P_1 | T Maximum | W Maximum | $A_0 B_0$ |
| 8 mm | Half (2 mm) | 6.25 (0.246) | 3.5 ± 0.05 (0.138 ±0.002) | 2.0 ± 0.05 (0.079 ±0.002) | 1.1 (0.098) | 8.3 (0.327) | Note 1 |
| 8 mm | Single (4 mm) | | | 4.0 ± 0.10 (0.157 ±0.004) | | | |

- The cavity defined by A_0 , B_0 and T shall surround the component with sufficient clearance that:
 - the component does not protrude beyond either surface of the carrier tape.
 - the component can be removed from the cavity in a vertical direction without mechanical restriction, after the top cover tape has been removed.
 - rotation of the component is limited to 20° maximum (see Figure 3).
 - lateral movement of the component is restricted to 0.5 mm maximum (see Figure 4).
 - see Addendum in EIA Standard 481 for standards relating to more precise taping requirements.
- The tape with or without components shall pass around R without damage (see Figure 6).

Packaging Information Performance Notes

- 1. Cover Tape Break Force:** 1.0 Kg minimum.
- 2. Cover Tape Peel Strength:** The total peel strength of the cover tape from the carrier tape shall be:

| Tape Width | Peel Strength |
|--------------|----------------------------------|
| 8 mm | 0.1 to 1.0 Newton (10 to 100 gf) |
| 12 and 16 mm | 0.1 to 1.3 Newton (10 to 130 gf) |

The direction of the pull shall be opposite the direction of the carrier tape travel. The pull angle of the carrier tape shall be 165° to 180° from the plane of the carrier tape. During peeling, the carrier and/or cover tape shall be pulled at a velocity of 300 ±10 mm/minute.

- 3. Labeling:** Bar code labeling (standard or custom) shall be on the side of the reel opposite the sprocket holes. Refer to EIA Standards 556 and 624.

Figure 3 – Maximum Component Rotation

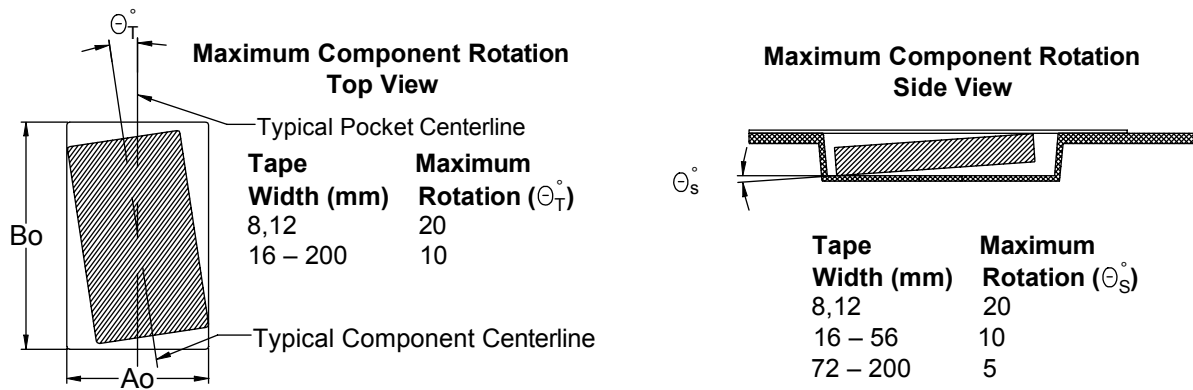

Figure 4 – Maximum Lateral Movement

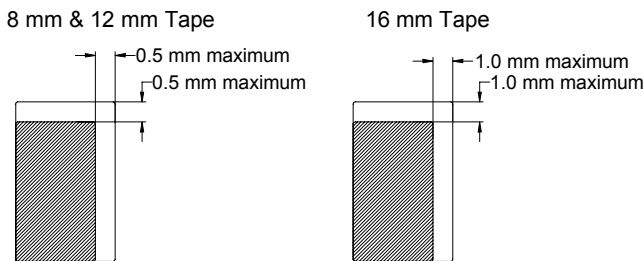

Figure 5 – Bending Radius

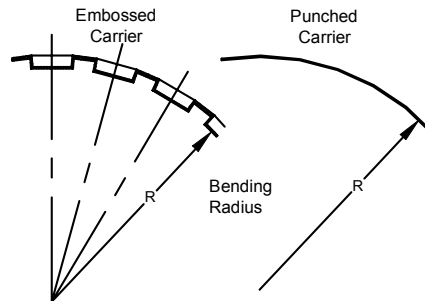
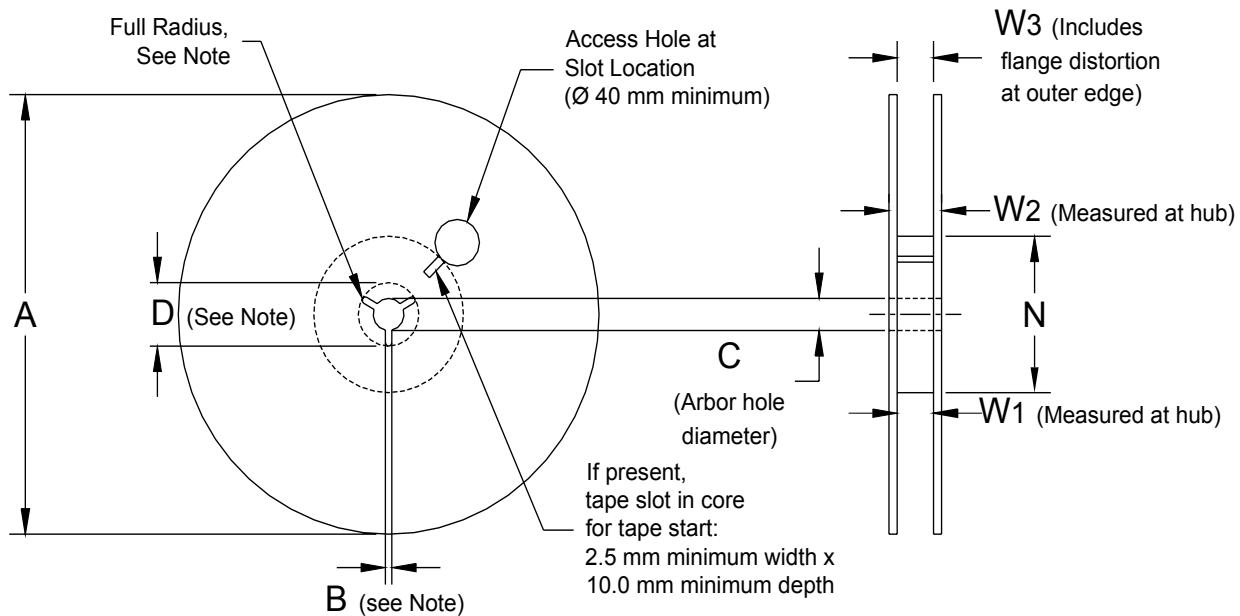

Figure 6 – Reel Dimensions



Note: Drive spokes optional; if used, dimensions B and D shall apply.

Table 8 – Reel Dimensions

Metric will govern

| Constant Dimensions — Millimeters (Inches) | | | | |
|--|---|---------------------------------------|--|--|
| Tape Size | A | B Minimum | C | D Minimum |
| 8 mm | 178 ±0.20 (7.008 ±0.008) or 330 ±0.20 (13.000 ±0.008) | 1.5 (0.059) | 13.0 +0.5/-0.2 (0.521 +0.02/-0.008) | 20.2 (0.795) |
| 12 mm | | | | |
| 16 mm | | | | |
| Variable Dimensions — Millimeters (Inches) | | | | |
| Tape Size | N Minimum | W ₁ | W ₂ Maximum | W ₃ |
| 8 mm | 50 (1.969) | 8.4 +1.5/-0.0 (0.331 +0.059/-0.0) | 14.4 (0.567) | Shall accommodate tape width without interference |
| 12 mm | | 12.4 +2.0/-0.0 (0.488 +0.078/-0.0) | 18.4 (0.724) | |
| 16 mm | | 16.4 +2.0/-0.0 (0.646 +0.078/-0.0) | 22.4 (0.882) | |

Figure 7 – Tape Leader & Trailer Dimensions

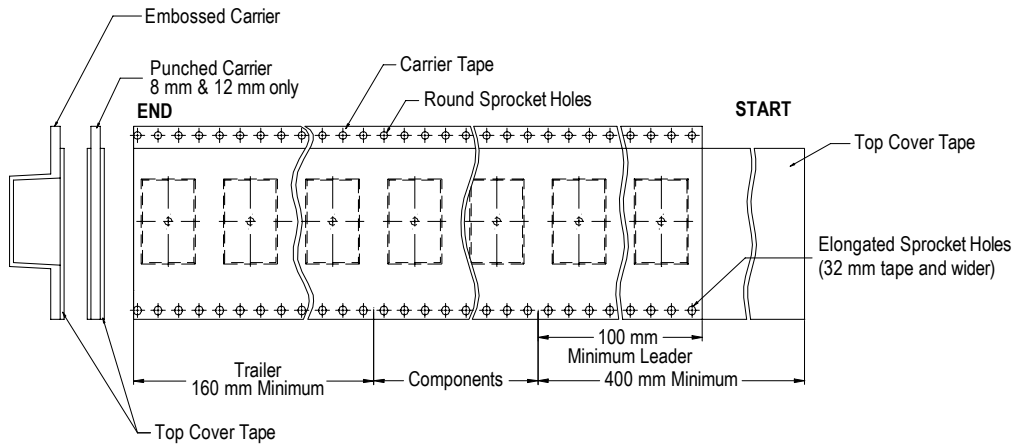
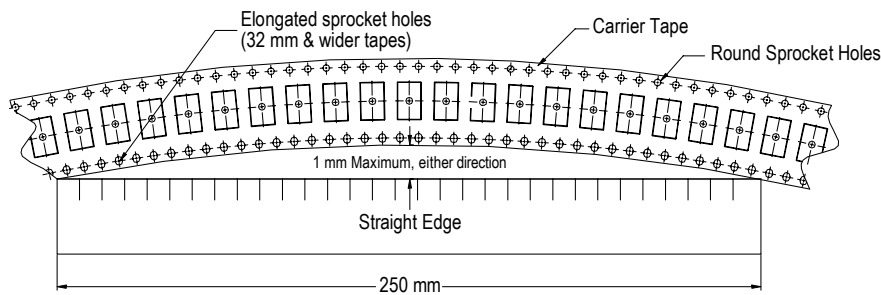

Figure 8 – Maximum Camber



KEMET Corporation World Headquarters

2835 KEMET Way
Simpsonville, SC 29681

Mailing Address:
P.O. Box 5928
Greenville, SC 29606

www.kemet.com
Tel: 864-963-6300
Fax: 864-963-6521

Corporate Offices
Fort Lauderdale, FL
Tel: 954-766-2800

North America

Southeast
Lake Mary, FL
Tel: 407-855-8886

Northeast
Wilmington, MA
Tel: 978-658-1663

Central
Novi, MI
Tel: 248-306-9353

West
Milpitas, CA
Tel: 408-433-9950

Mexico
Guadalajara, Jalisco
Tel: 52-33-3123-2141

Europe

Southern Europe
Paris, France
Tel: 33-1-4646-1006

Sasso Marconi, Italy
Tel: 39-051-939111

Central Europe
Landsberg, Germany
Tel: 49-8191-3350800

Kamen, Germany
Tel: 49-2307-438110

Northern Europe
Bishop's Stortford, United Kingdom
Tel: 44-1279-460122

Espoo, Finland
Tel: 358-9-5406-5000

Asia

Northeast Asia
Hong Kong
Tel: 852-2305-1168

Shenzhen, China
Tel: 86-755-2518-1306

Beijing, China
Tel: 86-10-5829-1711

Shanghai, China
Tel: 86-21-6447-0707

Taipei, Taiwan
Tel: 886-2-27528585

Southeast Asia
Singapore
Tel: 65-6586-1900

Penang, Malaysia
Tel: 60-4-6430200

Bangalore, India
Tel: 91-806-53-76817

Note: KEMET reserves the right to modify minor details of internal and external construction at any time in the interest of product improvement. KEMET does not assume any responsibility for infringement that might result from the use of KEMET Capacitors in potential circuit designs. KEMET is a registered trademark of KEMET Electronics Corporation.

Disclaimer

All product specifications, statements, information and data (collectively, the "Information") in this datasheet are subject to change. The customer is responsible for checking and verifying the extent to which the Information contained in this publication is applicable to an order at the time the order is placed.

All Information given herein is believed to be accurate and reliable, but it is presented without guarantee, warranty, or responsibility of any kind, expressed or implied.

Statements of suitability for certain applications are based on KEMET Electronics Corporation's ("KEMET") knowledge of typical operating conditions for such applications, but are not intended to constitute – and KEMET specifically disclaims – any warranty concerning suitability for a specific customer application or use. The Information is intended for use only by customers who have the requisite experience and capability to determine the correct products for their application. Any technical advice inferred from this Information or otherwise provided by KEMET with reference to the use of KEMET's products is given gratis, and KEMET assumes no obligation or liability for the advice given or results obtained.

Although KEMET designs and manufactures its products to the most stringent quality and safety standards, given the current state of the art, isolated component failures may still occur. Accordingly, customer applications which require a high degree of reliability or safety should employ suitable designs or other safeguards (such as installation of protective circuitry or redundancies) in order to ensure that the failure of an electrical component does not result in a risk of personal injury or property damage.

Although all product-related warnings, cautions and notes must be observed, the customer should not assume that all safety measures are indicated or that other measures may not be required.