

## Standard Rectifier

$$V_{RRM} = 2 \times 1600 \text{ V}$$

$$I_{FAV} = 10 \text{ A}$$

$$V_F = 1.18 \text{ V}$$

Phase leg

Part number

**DMA10P1600HR**

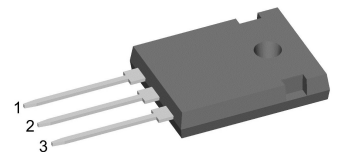

Backside: isolated

 E72873

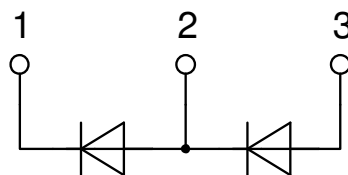

### Features / Advantages:

- Planar passivated chips
- Very low leakage current
- Very low forward voltage drop
- Improved thermal behaviour

### Applications:

- Diode for main rectification
- For single and three phase bridge configurations

### Package: ISO247

- Isolation Voltage: 3600 V~
- Industry standard outline
- RoHS compliant
- Epoxy meets UL 94V-0
- Soldering pins for PCB mounting
- Backside: DCB ceramic
- Reduced weight
- Advanced power cycling

### Terms Conditions of usage:

The data contained in this product data sheet is exclusively intended for technically trained staff. The user will have to evaluate the suitability of the product for the intended application and the completeness of the product data with respect to his application. The specifications of our components may not be considered as an assurance of component characteristics. The information in the valid application- and assembly notes must be considered. Should you require product information in excess of the data given in this product data sheet or which concerns the specific application of your product, please contact your local sales office.

Due to technical requirements our product may contain dangerous substances. For information on the types in question please contact your local sales office.

Should you intend to use the product in aviation, in health or life endangering or life support applications, please notify. For any such application we urgently recommend

- to perform joint risk and quality assessments;

- the conclusion of quality agreements;

- to establish joint measures of an ongoing product survey, and that we may make delivery dependent on the realization of any such measures.

Rectifier				Ratings			
Symbol	Definition	Conditions	min.	typ.	max.	Unit	
$V_{RSM}$	max. non-repetitive reverse blocking voltage				1700	V	
$V_{RRM}$	max. repetitive reverse blocking voltage				1600	V	
$I_R$	reverse current	$V_R = 1600$ V			10	$\mu$ A	
		$V_R = 1600$ V			0.2	mA	
$V_F$	forward voltage drop	$I_F = 10$ A			1.23	V	
		$I_F = 20$ A			1.46	V	
		$I_F = 10$ A			1.18	V	
		$I_F = 20$ A			1.49	V	
$I_{FAV}$	average forward current	$T_C = 145^\circ$ C			10	A	
		rectangular					
$V_{FO}$	threshold voltage	} for power loss calculation only			0.81	V	
$r_F$	slope resistance				34	m $\Omega$	
$R_{thJC}$	thermal resistance junction to case				2	K/W	
$R_{thCH}$	thermal resistance case to heatsink			0.25		K/W	
$P_{tot}$	total power dissipation				75	W	
$I_{FSM}$	max. forward surge current	$t = 10$ ms; (50 Hz), sine			120	A	
		$t = 8,3$ ms; (60 Hz), sine			130	A	
		$t = 10$ ms; (50 Hz), sine			100	A	
		$t = 8,3$ ms; (60 Hz), sine			110	A	
$I^2t$	value for fusing	$t = 10$ ms; (50 Hz), sine			72	A <sup>2</sup> s	
		$t = 8,3$ ms; (60 Hz), sine			70	A <sup>2</sup> s	
		$t = 10$ ms; (50 Hz), sine			50	A <sup>2</sup> s	
		$t = 8,3$ ms; (60 Hz), sine			50	A <sup>2</sup> s	
$C_J$	junction capacitance	$V_R = 400$ V; $f = 1$ MHz			4	pF	

Package ISO247		Ratings				
Symbol	Definition	Conditions	min.	typ.	max.	Unit
$I_{RMS}$	RMS current	per terminal			70	A
$T_{VJ}$	virtual junction temperature		-55		175	°C
$T_{op}$	operation temperature		-55		150	°C
$T_{stg}$	storage temperature		-55		150	°C
<b>Weight</b>				6		g
$M_D$	mounting torque		0.8		1.2	Nm
$F_C$	mounting force with clip		20		120	N
$d_{Spp/App}$	creepage distance on surface   striking distance through air	terminal to terminal	2.7			mm
$d_{Spb/Apb}$		terminal to backside	4.1			mm
$V_{ISOL}$	isolation voltage	t = 1 second	3600			V
		t = 1 minute	3000			V

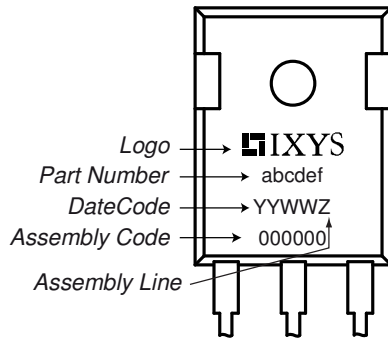
**Product Marking**

**Part description**

- D = Diode
- M = Standard Rectifier
- A = (up to 1800V)
- 10 = Current Rating [A]
- P = Phase leg
- 1600 = Reverse Voltage [V]
- HR = ISO247 (3)

Ordering	Ordering Number	Marking on Product	Delivery Mode	Quantity	Code No.
Standard	DMA10P1600HR	DMA10P1600HR	Tube	30	522535

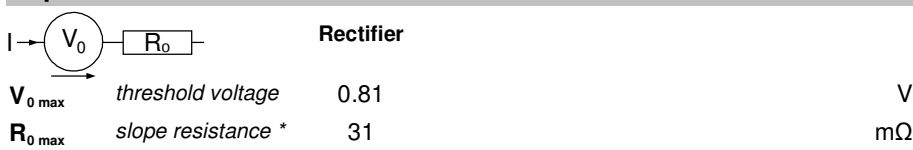
Similar Part	Package	Voltage class
DMA10P1200HR	ISO247 (3)	1200

**Equivalent Circuits for Simulation**
*\* on die level*
 $T_{VJ} = 175\text{ °C}$ 

## Outlines ISO247

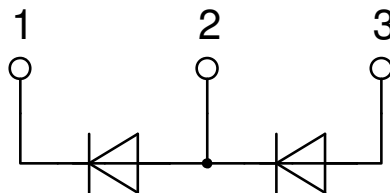
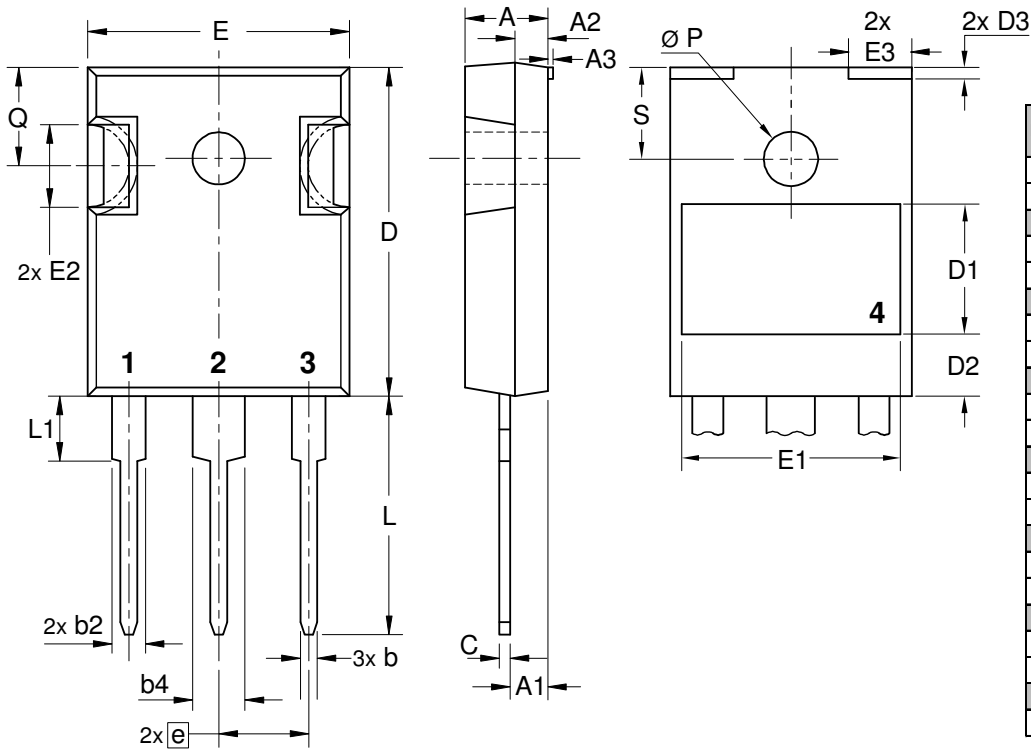

## Rectifier

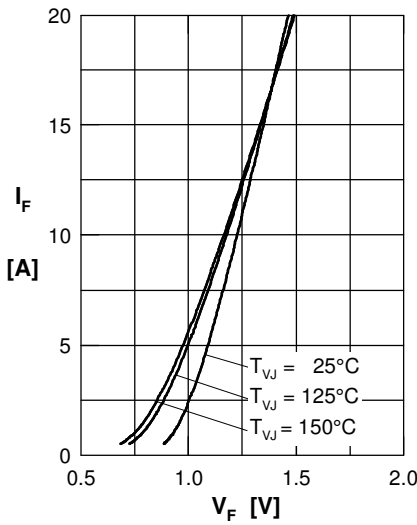

Fig. 1 Forward current versus voltage drop per diode

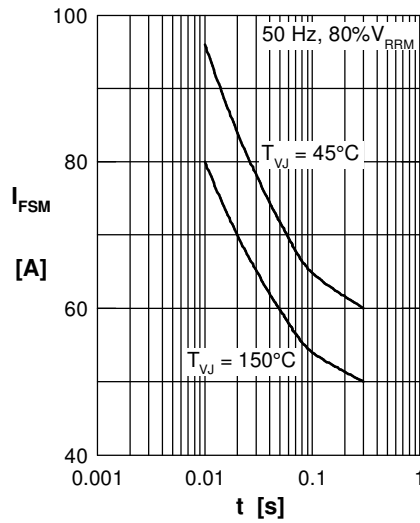

Fig. 2 Surge overload current

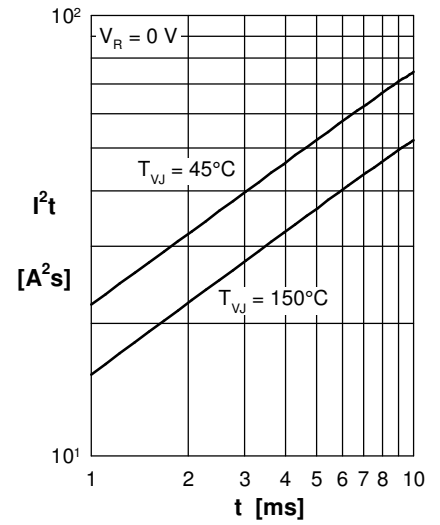

Fig. 3  $I^2t$  versus time per diode

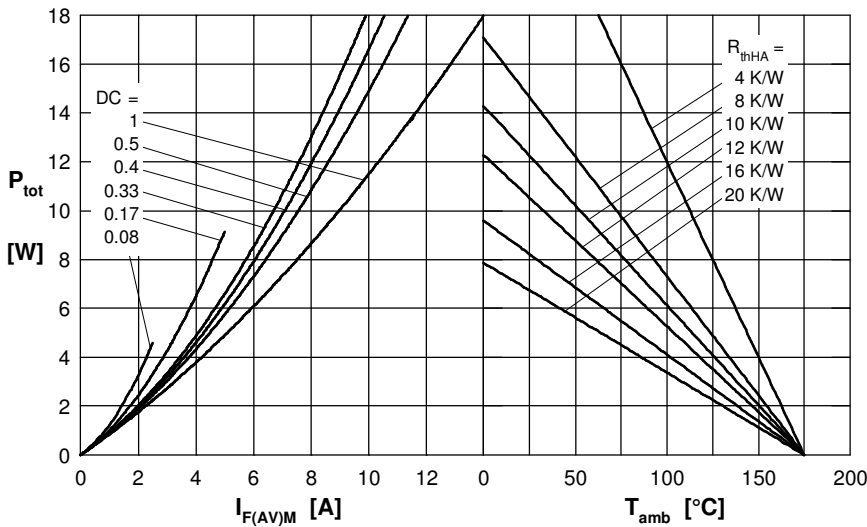

Fig. 4 Power dissipation vs. direct output current and ambient temperature

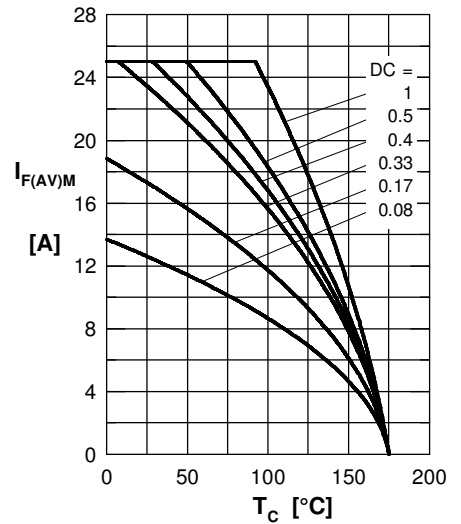

Fig. 5 Max. forward current vs. case temperature

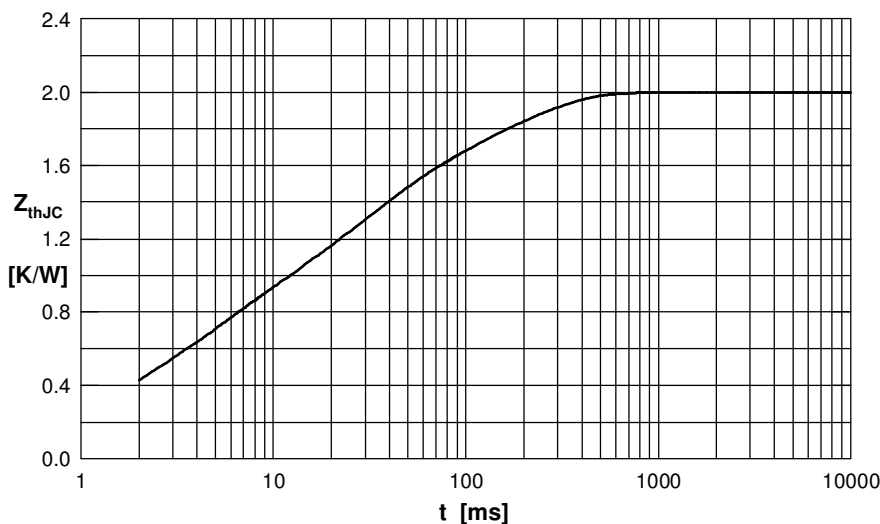

Fig. 6 Transient thermal impedance junction to case

Constants for  $Z_{thJC}$  calculation:

i	$R_{thi}$ (K/W)	$t_i$ (s)
1	0.06	0.0004
2	0.23	0.0020
3	0.40	0.0040
4	0.71	0.0240
5	0.60	0.1500