



TAI-SAW TECHNOLOGY CO., LTD.

No. 3, Industrial 2nd Rd., Ping-Chen Industrial District,
Taoyuan, 324, Taiwan, R.O.C.

TEL: 886-3-4690038 FAX: 886-3-4697532

E-mail: tstsales@mail.taisaw.com Web: www.taisaw.com

Approval Sheet For Product Specification

Issued Date:

Product Name: SAW Resonator 868.98 MHz SMD 3X3 mm

TST Parts No.: TC0326A

Customer Parts No.: _____

Company: _____
Division: _____
Approved by : _____
Date: _____

Checked by: Paul Ni

Approval by: Francis Chen

Date: 2006/9/04



TAI-SAW TECHNOLOGY CO., LTD.

No. 3, Industrial 2nd Rd., Ping-Chen Industrial District,
Taoyuan, 324, Taiwan, R.O.C.

TEL: 886-3-4690038 FAX: 886-3-4697532

E-mail: tstsales@mail.taisaw.com Web: www.taisaw.com

SAW Resonator 868.98 MHz

MODEL NO.: TC0326A

REV. NO.: 1.0

A. FEATURES:

1. 1-Port Resonator.

B. MAXIMUM RATING:

1. Input Power Level: 0 dBm

2. DC voltage: 5 V

3. Operating Temperature: -40°C to +85°C

4. Storage Temperature: -40°C to +85°C

C. ELECTRICAL CHARACTERISTICS:

Characteristic	Units	Minimum	Typical	Maximum
Center frequency Fr	MHz	868.905	868.98	869.055
Insertion Loss IL	dB	-	1.1	2.0
Equivalent Elements				
Motional capacitance C1	fF	-	0.97	-
Motional inductance L1	μH	-	34.64	-
Motional resistance R1	Ohm	-	21.93	-
Parallel capacitance Co	pF	-	2.25	-
Temp.coeff.	ppm/c*2	-	0.032	-
Turnover To	deg.C	-	25	-
Package size		SMD 3.0X3.0X1.4mm		

RoHS Compliant
Lead free
Lead-free soldering

D. EQUIVIRENT CIRCUIT:

One-Port Resonator:

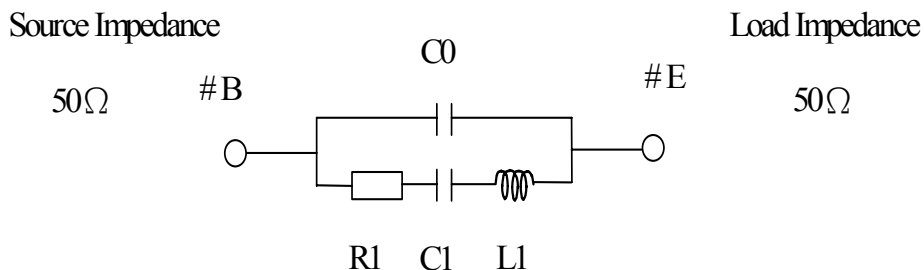

E. OUTLINE DRAWING:

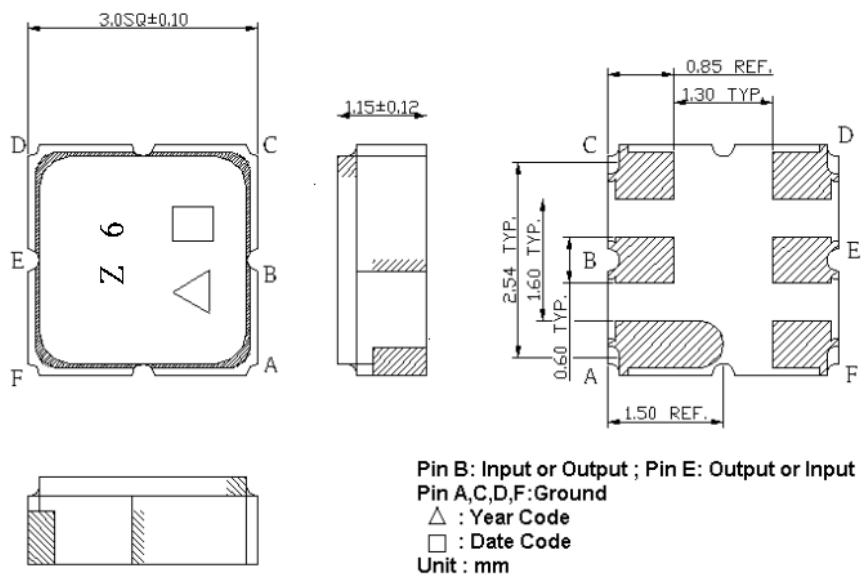

Date code: Provided by planer each year
 Year code: 6 for 2006, 7 for 2007, ...

F. FREQUENCY CHARACTERISTICS



G. TEST CIRCUIT:

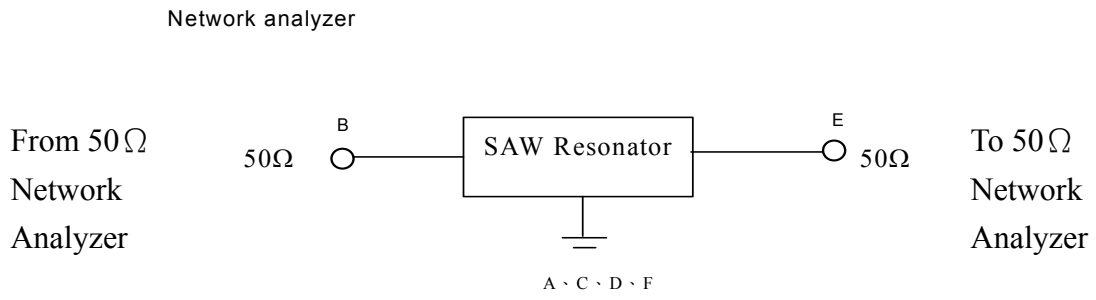

H. LAND PATTERN:

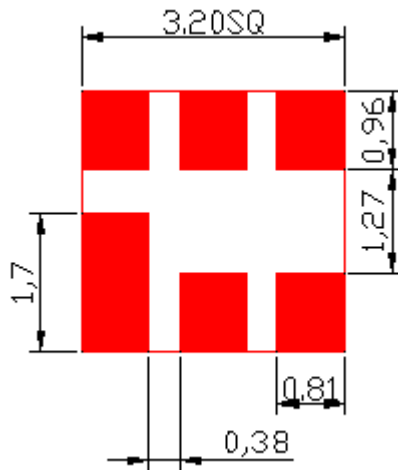

I. PACKING:

1. REEL DIMENSION

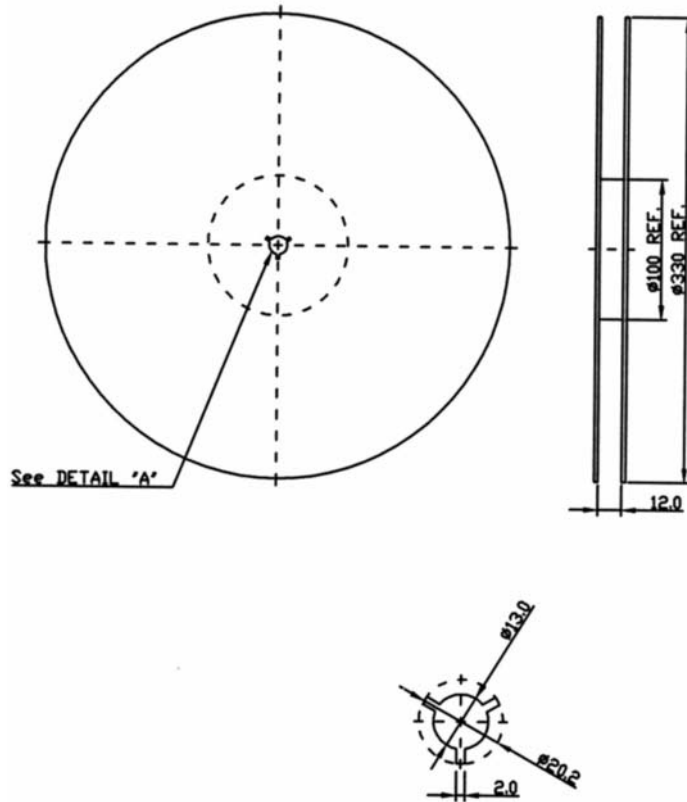

2. TAPE DIMENSION

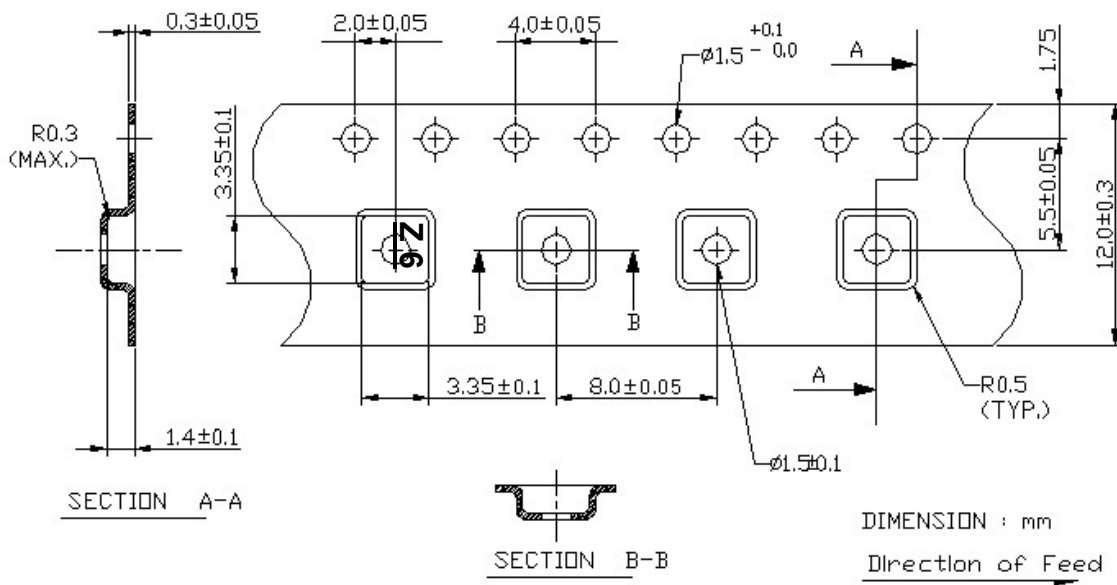

J. RECOMMENDED REFLOW PROFILE:

