

## Features

- Standard-voltage Operation
  - 2.7 (V<sub>CC</sub> = 2.7V to 5.5V)
- Automotive Temperature Range –40°C to 125°C
- Internally Organized 128 x 8 (1K), 256 x 8 (2K), 512 x 8 (4K), 1024 x 8 (8K) or 2048 x 8 (16K)
- Two-wire Serial Interface
- Schmitt Trigger, Filtered Inputs for Noise Suppression
- Bidirectional Data Transfer Protocol
- 400 kHz Compatibility
- Write Protect Pin for Hardware Data Protection
- 8-byte Page (1K, 2K), 16-byte Page (4K, 8K, 16K) Write Modes
- Partial Page Writes are Allowed
- Self-timed Write Cycle (5 ms max)
- High-reliability
  - Endurance: 1 Million Write Cycles
  - Data Retention: 100 Years
- 8-lead JEDEC SOIC and 8-lead TSSOP Packages

## Description

The AT24C01A/02/04/08A/16A provides 1024/2048/4096/8192/16384 bits of serial electrically erasable and programmable read-only memory (EEPROM) organized as 128/256/512/1024/2048 words of 8 bits each. The device is optimized for use in many automotive applications where low-power and low-voltage operation are essential. The AT24C01A/02/04/08A/16A is available in space-saving 8-lead JEDEC SOIC and 8-lead TSSOP packages and is accessed via a two-wire serial interface. In addition, the entire family is available in 2.7V (2.7V to 5.5V) versions.

**Table 1.** Pin Configurations

| Pin Name | Function           |
|----------|--------------------|
| A0 – A2  | Address Inputs     |
| SDA      | Serial Data        |
| SCL      | Serial Clock Input |
| WP       | Write Protect      |
| NC       | No Connect         |

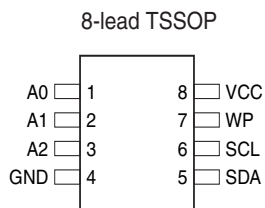
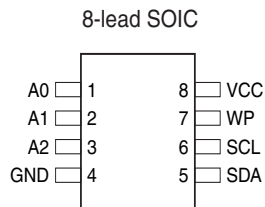

## Two-wire Automotive Temperature Serial EEPROM

1K (128 x 8)

2K (256 x 8)

4K (512 x 8)

8K (1024 x 8)

16K (2048 x 8)

**AT24C01A<sup>(1)</sup>**

**AT24C02<sup>(2)</sup>**

**AT24C04**

**AT24C08A**

**AT24C16A<sup>(3)</sup>**

1. AT24C01A not recommended for new design; Replaced by AT24C01B Automotive.
2. AT24C02 not recommended for new design; Replaced by AT24C02B Automotive.
3. AT24C16A not recommended for new design; replaced by AT24C16C Automotive.



## Absolute Maximum Ratings

|  |                 |
|--|-----------------|
| Operating Temperature .....                        | -55°C to +125°C |
| Storage Temperature.....                           | -65°C to +150°C |
| Voltage on Any Pin<br>with Respect to Ground ..... | -1.0V to +7.0V  |
| Maximum Operating Voltage .....                    | 6.25V           |
| DC Output Current.....                             | 5.0 mA          |

**\*NOTICE:** Stresses beyond those listed under “Absolute Maximum Ratings” may cause permanent damage to the device. This is a stress rating only and functional operation of the device at these or any other conditions beyond those indicated in the operational sections of this specification is not implied. Exposure to absolute maximum rating conditions for extended periods may affect device reliability.

**Figure 1.** Block Diagram

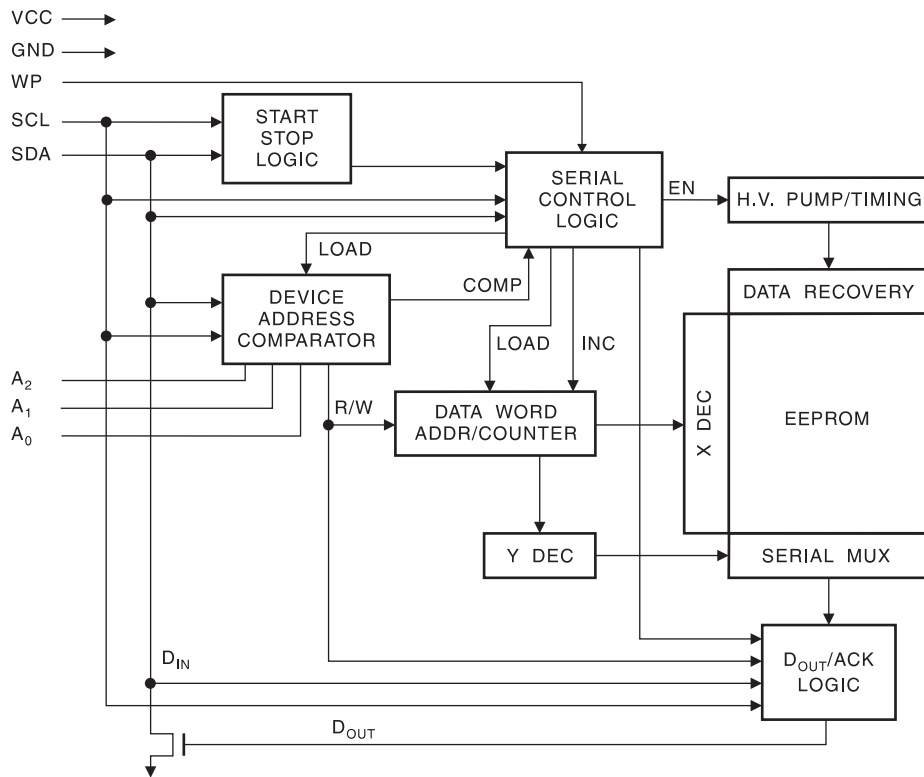

## Pin Description

**SERIAL CLOCK (SCL):** The SCL input is used to positive edge clock data into each EEPROM device and negative edge clock data out of each device.

**SERIAL DATA (SDA):** The SDA pin is bi-directional for serial data transfer. This pin is open-drain driven and may be wire-ORed with any number of other open-drain or open-collector devices.

**DEVICE/PAGE ADDRESSES (A2, A1, A0):** The A2, A1 and A0 pins are device address inputs that are hard wired for the AT24C01A and the AT24C02. As many as eight 1K/2K devices may be addressed on a single bus system (device addressing is discussed in detail under the Device Addressing section).

The AT24C04 uses the A2 and A1 inputs for hard wire addressing and a total of four 4K devices may be addressed on a single bus system. The A0 pin is a no connect.

The AT24C08A only uses the A2 input for hardwire addressing and a total of two 8K devices may be addressed on a single bus system. The A0 and A1 pins are no connects.

The AT24C16A does not use the device address pins, which limits the number of devices on a single bus to one. The A0, A1 and A2 pins are no connects.

**WRITE PROTECT (WP):** The AT24C01A/02/04/08A/16A has a Write Protect pin that provides hardware data protection. The Write Protect pin allows normal read/write operations when connected to ground (GND). When the Write Protect pin is connected to  $V_{CC}$ , the write protection feature is enabled and operates as shown in the following table.

**Table 2. Write Protect**

| WP Pin Status | Part of the Array Protected  |                 |                 |                 |                  |
|---------------|------------------------------|-----------------|-----------------|-----------------|------------------|
|               | 24C01A                       | 24C02           | 24C04           | 24C08A          | 24C16A           |
| At $V_{CC}$   | Full (1K) Array              | Full (2K) Array | Full (4K) Array | Full (8K) Array | Full (16K) Array |
| At GND        | Normal Read/Write Operations |                 |                 |                 |                  |

- Memory Organization**
- AT24C01A, 1K SERIAL EEPROM:** Internally organized with 16 pages of 8 bytes each, the 1K requires a 7-bit data word address for random word addressing.
  - AT24C02, 2K SERIAL EEPROM:** Internally organized with 32 pages of 8 bytes each, the 2K requires an 8-bit data word address for random word addressing.
  - AT24C04, 4K SERIAL EEPROM:** Internally organized with 32 pages of 16 bytes each, the 4K requires a 9-bit data word address for random word addressing.
  - AT24C08A, 8K SERIAL EEPROM:** Internally organized with 64 pages of 16 bytes each, the 8K requires a 10-bit data word address for random word addressing.
  - AT24C16A, 16K SERIAL EEPROM:** Internally organized with 128 pages of 16 bytes each, the 16K requires an 11-bit data word address for random word addressing.

**Table 3.** Pin Capacitance<sup>(1)</sup>

Applicable over recommended operating range from  $T_A = 25^\circ\text{C}$ ,  $f = 1.0\text{ MHz}$ ,  $V_{CC} = +2.7\text{V}$

| Symbol    | Test Condition                                    | Max | Units | Conditions            |
|-----------|---|-----|-------|-----------------------|
| $C_{I/O}$ | Input/Output Capacitance (SDA)                    | 8   | pF    | $V_{I/O} = 0\text{V}$ |
| $C_{IN}$  | Input Capacitance ( $A_0, A_1, A_2, \text{SCL}$ ) | 6   | pF    | $V_{IN} = 0\text{V}$  |

Note: 1. This parameter is characterized and is not 100% tested.

**Table 4.** DC Characteristics

Applicable over recommended operating range from:  $T_A = -40^\circ\text{C}$  to  $+125^\circ\text{C}$ ,  $V_{CC} = +2.7\text{V}$  to  $+5.5\text{V}$  (unless otherwise noted)

| Symbol    | Parameter                               | Test Condition                 | Min                 | Typ  | Max                 | Units         |
|-----------|---|--------------------------------|---------------------|------|---------------------|---------------|
| $V_{CC1}$ | Supply Voltage                          |                                | 2.7                 |      | 5.5                 | V             |
| $I_{CC}$  | Supply Current $V_{CC} = 5.0\text{V}$   | Read at 100 kHz                |                     | 0.4  | 1.0                 | mA            |
| $I_{CC}$  | Supply Current $V_{CC} = 5.0\text{V}$   | Write at 100 kHz               |                     | 2.0  | 3.0                 | mA            |
| $I_{SB1}$ | Standby Current $V_{CC} = 2.7\text{V}$  | $V_{IN} = V_{CC}$ or $V_{SS}$  |                     | 1.6  | 4.0                 | $\mu\text{A}$ |
| $I_{SB2}$ | Standby Current $V_{CC} = 5.0\text{V}$  | $V_{IN} = V_{CC}$ or $V_{SS}$  |                     | 8.0  | 18.0                | $\mu\text{A}$ |
| $I_{LI}$  | Input Leakage Current                   | $V_{IN} = V_{CC}$ or $V_{SS}$  |                     | 0.10 | 3.0                 | $\mu\text{A}$ |
| $I_{LO}$  | Output Leakage Current                  | $V_{OUT} = V_{CC}$ or $V_{SS}$ |                     | 0.05 | 3.0                 | $\mu\text{A}$ |
| $V_{IL}$  | Input Low Level <sup>(1)</sup>          |                                | -0.6                |      | $V_{CC} \times 0.3$ | V             |
| $V_{IH}$  | Input High Level <sup>(1)</sup>         |                                | $V_{CC} \times 0.7$ |      | $V_{CC} + 0.5$      | V             |
| $V_{OL2}$ | Output Low Level $V_{CC} = 3.0\text{V}$ | $I_{OL} = 2.1\text{ mA}$       |                     |      | 0.4                 | V             |
| $V_{OL1}$ | Output Low Level $V_{CC} = 1.8\text{V}$ | $I_{OL} = 0.15\text{ mA}$      |                     |      | 0.2                 | V             |

Note: 1.  $V_{IL}$  min and  $V_{IH}$  max are reference only and are not tested.

**Table 5.** AC Characteristics

Applicable over recommended operating range from  $T_A = -40^{\circ}\text{C}$  to  $+125^{\circ}\text{C}$ ,  $V_{CC} = +2.7\text{V}$  to  $+5.5\text{V}$ ,  $CL = 1$  TTL Gate and  $100\text{ pF}$  (unless otherwise noted)

| Symbol                   | Parameter  | AT24C01A/02/04/08A/16A |     | Units         |
|--------------------------|--|------------------------|-----|---------------|
|                          |  | Min                    | Max |               |
| $f_{\text{SCL}}$         | Clock Frequency, SCL   |                        | 400 | kHz           |
| $t_{\text{LOW}}$         | Clock Pulse Width Low  | 1.2                    |     | $\mu\text{s}$ |
| $t_{\text{HIGH}}$        | Clock Pulse Width High   | 0.6                    |     | $\mu\text{s}$ |
| $t_{\text{I}}$           | Noise Suppression Time <sup>(1)</sup>  |                        | 50  | ns            |
| $t_{\text{AA}}$          | Clock Low to Data Out Valid  | 0.1                    | 0.9 | $\mu\text{s}$ |
| $t_{\text{BUF}}$         | Time the bus must be free before a new transmission can start <sup>(2)</sup> | 1.2                    |     | $\mu\text{s}$ |
| $t_{\text{HD,STA}}$      | Start Hold Time  | 0.6                    |     | $\mu\text{s}$ |
| $t_{\text{SU,STA}}$      | Start Set-up Time  | 0.6                    |     | $\mu\text{s}$ |
| $t_{\text{HD,DAT}}$      | Data In Hold Time  | 0                      |     | $\mu\text{s}$ |
| $t_{\text{SU,DAT}}$      | Data In Set-up Time  | 100                    |     | ns            |
| $t_{\text{R}}$           | Inputs Rise Time <sup>(2)</sup>  |                        | 300 | ns            |
| $t_{\text{F}}$           | Inputs Fall Time <sup>(2)</sup>  |                        | 300 | ns            |
| $t_{\text{SU,STO}}$      | Stop Set-up Time   | 0.6                    |     | $\mu\text{s}$ |
| $t_{\text{DH}}$          | Data Out Hold Time   | 50                     |     | ns            |
| $t_{\text{WR}}$          | Write Cycle Time   |                        | 5   | ms            |
| Endurance <sup>(2)</sup> | 5.0V, $25^{\circ}\text{C}$ , Page Mode                                       | 1M                     |     | Write Cycles  |

- Note: 1. This parameter is characterized and is not 100% tested ( $T_A = 25^{\circ}\text{C}$ ).  
 2. This parameter is characterized.

## Device Operation

**CLOCK and DATA TRANSITIONS:** The SDA pin is normally pulled high with an external device. Data on the SDA pin may change only during SCL low time periods (see to Figure 4 on page 7). Data changes during SCL high periods will indicate a start or stop condition as defined below.

**START CONDITION:** A high-to-low transition of SDA with SCL high is a start condition which must precede any other command (see to Figure 5 on page 7).

**STOP CONDITION:** A low-to-high transition of SDA with SCL high is a stop condition. After a read sequence, the stop command will place the EEPROM in a standby power mode (see Figure 5 on page 7).

**ACKNOWLEDGE:** All addresses and data words are serially transmitted to and from the EEPROM in 8-bit words. The EEPROM sends a “0” to acknowledge that it has received each word. This happens during the ninth clock cycle.

**STANDBY MODE:** The AT24C01A/02/04/08A/16A features a low-power standby mode which is enabled: (a) upon power-up and (b) after the receipt of the STOP bit and the completion of any internal operations.

**MEMORY RESET:** After an interruption in protocol, power loss or system reset, any two-wire part can be reset by following these steps:

1. Clock up to 9 cycles.
2. Look for SDA high in each cycle while SCL is high.
3. Create a start condition.

## Bus Timing

Figure 2. SCL: Serial Clock, SDA: Serial Data I/O

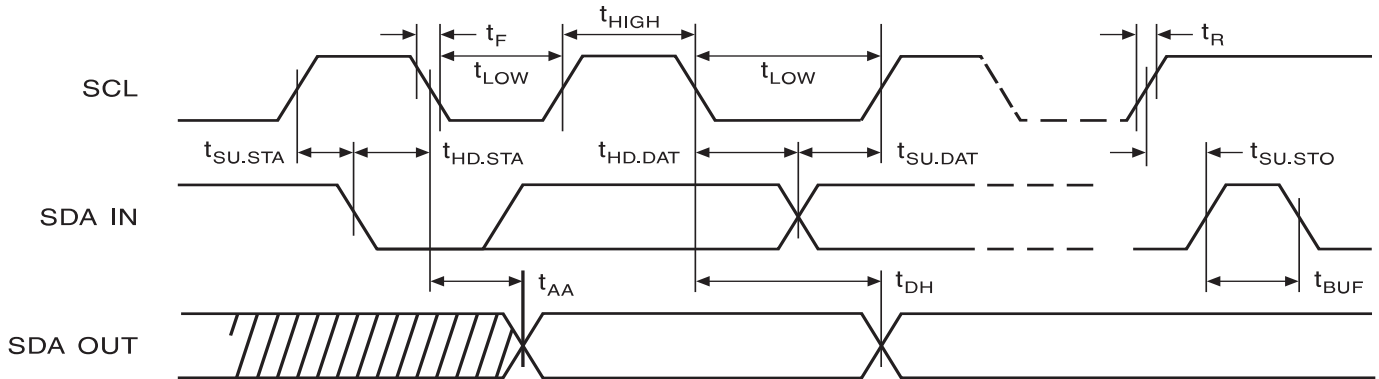

## Write Cycle Timing

Figure 3. SCL: Serial Clock, SDA: Serial Data I/O

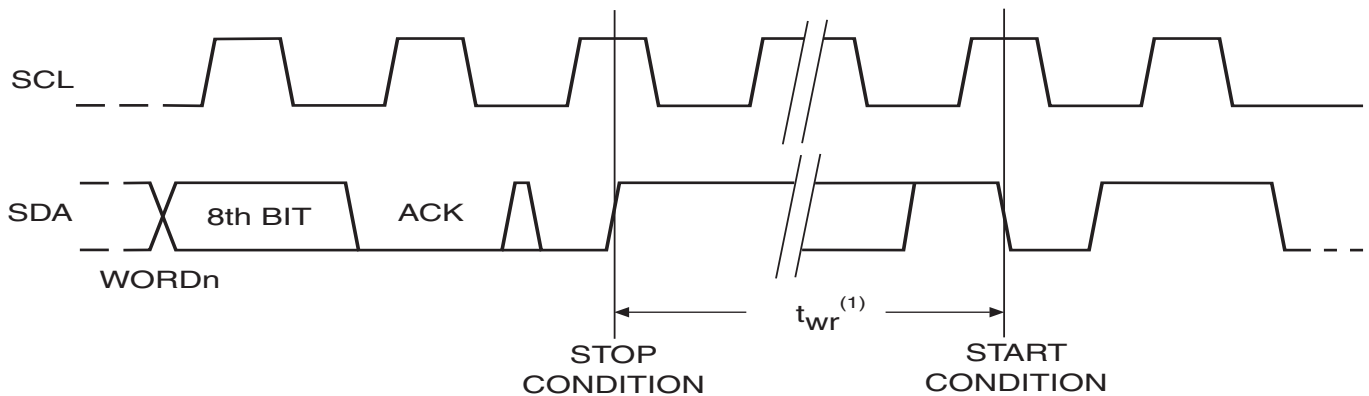

Note: 1. The write cycle time  $t_{WR}$  is the time from a valid stop condition of a write sequence to the end of the internal clear/write cycle.

Figure 4. Data Validity

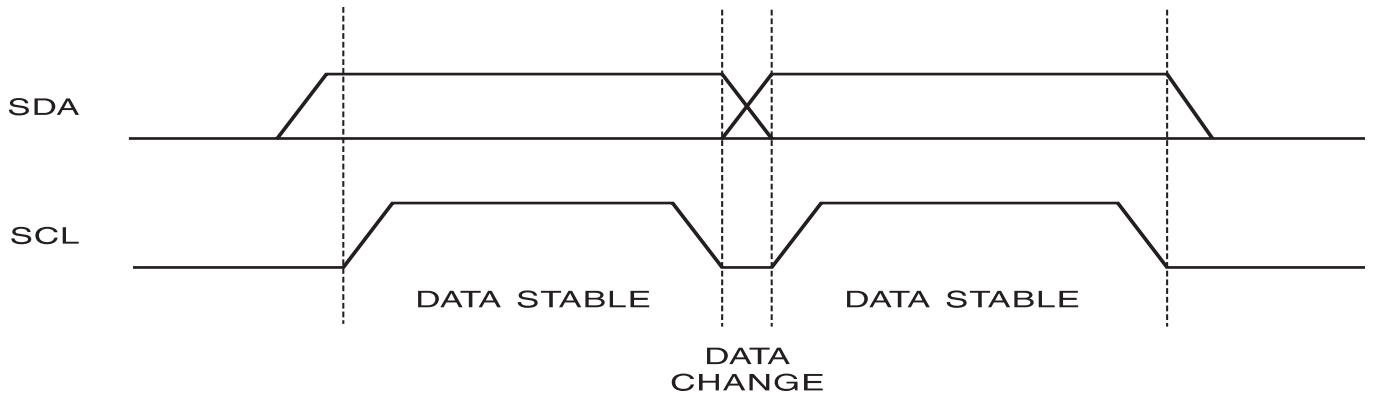

Figure 5. Start and Stop Definition

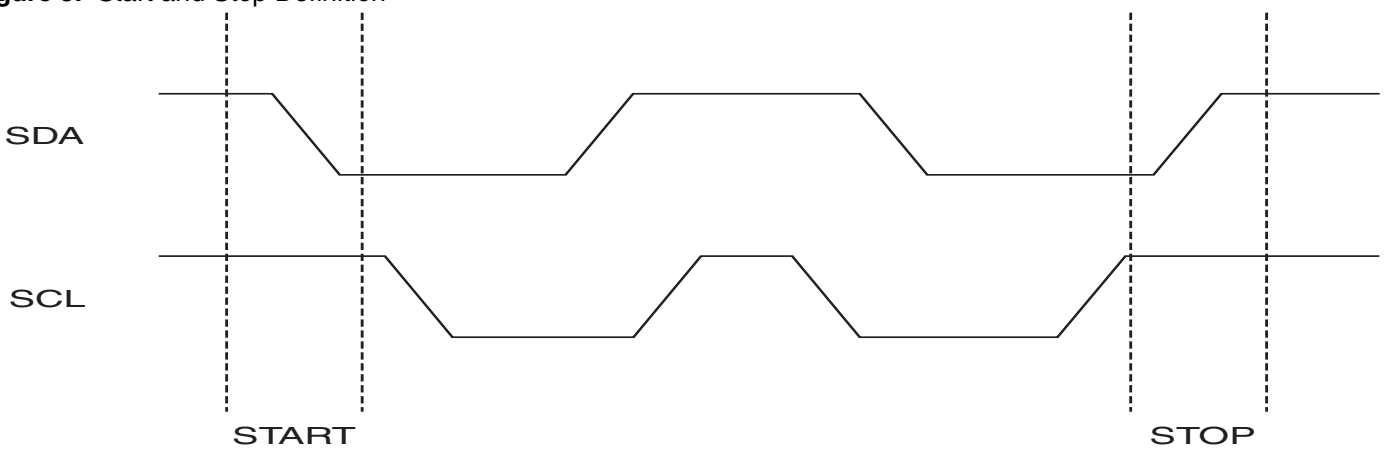
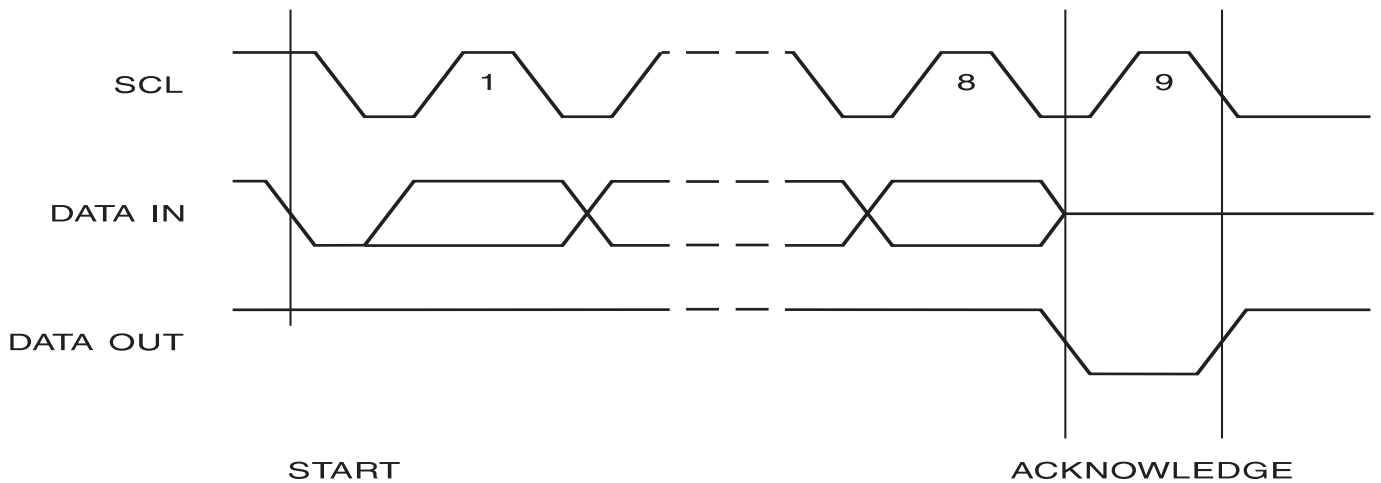

Figure 6. Output Acknowledge



## Device Addressing

The 1K, 2K, 4K, 8K and 16K EEPROM devices all require an 8-bit device address word following a start condition to enable the chip for a read or write operation (see to Figure 7 on page 9).

The device address word consists of a mandatory “1”, “0” sequence for the first four most significant bits as shown. This is common to all the Serial EEPROM devices.

The next 3 bits are the A2, A1 and A0 device address bits for the 1K/2K EEPROM. These 3 bits must compare to their corresponding hardwired input pins.

The 4K EEPROM only uses the A2 and A1 device address bits with the third bit being a memory page address bit. The two device address bits must compare to their corresponding hardwired input pins. The A0 pin is no connect.

The 8K EEPROM only uses the A2 device address bit with the next two bits being for memory page addressing. The A2 bit must compare to its corresponding hardwired input pin. The A1 and A0 pins are no connect.

The 16K does not use any device address bits but instead the three bits are used for memory page addressing. These page addressing bits on the 4K, 8K and 16K devices should be considered the most significant bits of the data word address which follows. The A0, A1 and A2 pins are no connect.

The eighth bit of the device address is the read/write operation select bit. A read operation is initiated if this bit is high and a write operation is initiated if this bit is low.

Upon a compare of the device address, the EEPROM will output a “0”. If a compare is not made, the chip will return to a standby state.

## Write Operations

**BYTE WRITE:** A write operation requires an 8-bit data word address following the device address word and acknowledgment. Upon receipt of this address, the EEPROM will again respond with a “0” and then clock in the first 8-bit data word. Following receipt of the 8-bit data word, the EEPROM will output a “0” and the addressing device, such as a microcontroller, must terminate the write sequence with a stop condition. At this time the EEPROM enters an internally timed write cycle,  $t_{WR}$ , to the nonvolatile memory. All inputs are disabled during this write cycle and the EEPROM will not respond until the write is complete (see Figure 8 on page 10).

**PAGE WRITE:** The 1K/2K EEPROM is capable of an 8-byte page write, and the 4K, 8K and 16K devices are capable of 16-byte page writes.

A page write is initiated the same as a byte write, but the microcontroller does not send a stop condition after the first data word is clocked in. Instead, after the EEPROM acknowledges receipt of the first data word, the microcontroller can transmit up to seven (1K/2K) or fifteen (4K, 8K, 16K) more data words. The EEPROM will respond with a “0” after each data word received. The microcontroller must terminate the page write sequence with a stop condition (see Figure 9 on page 10).

The data word address lower three (1K/2K) or four (4K, 8K, 16K) bits are internally incremented following the receipt of each data word. The higher data word address bits are not incremented, retaining the memory page row location. When the word address, internally generated, reaches the page boundary, the following byte is placed at the beginning of the same page. If more than eight (1K/2K) or sixteen (4K, 8K, 16K) data words are transmitted to the EEPROM, the data word address will “roll over” and previous data will be overwritten.

**ACKNOWLEDGE POLLING:** Once the internally timed write cycle has started and the EEPROM inputs are disabled, acknowledge polling can be initiated. This involves send-



ing a start condition followed by the device address word. The read/write bit is representative of the operation desired. Only if the internal write cycle has completed will the EEPROM respond with a “0”, allowing the read or write sequence to continue.

## Read Operations

Read operations are initiated the same way as write operations with the exception that the read/write select bit in the device address word is set to “1”. There are three read operations: current address read, random address read and sequential read.

**CURRENT ADDRESS READ:** The internal data word address counter maintains the last address accessed during the last read or write operation, incremented by one. This address stays valid between operations as long as the chip power is maintained. The address “roll over” during read is from the last byte of the last memory page to the first byte of the first page. The address “roll over” during write is from the last byte of the current page to the first byte of the same page.

Once the device address with the read/write select bit set to “1” is clocked in and acknowledged by the EEPROM, the current address data word is serially clocked out. The microcontroller does not respond with an input “0” but does generate a following stop condition (see Figure 10 on page 10).

**RANDOM READ:** A random read requires a “dummy” byte write sequence to load in the data word address. Once the device address word and data word address are clocked in and acknowledged by the EEPROM, the microcontroller must generate another start condition. The microcontroller now initiates a current address read by sending a device address with the read/write select bit high. The EEPROM acknowledges the device address and serially clocks out the data word. The microcontroller does not respond with a “0” but does generate a following stop condition (see Figure 11 on page 11).

**SEQUENTIAL READ:** Sequential reads are initiated by either a current address read or a random address read. After the microcontroller receives a data word, it responds with an acknowledge. As long as the EEPROM receives an acknowledge, it will continue to increment the data word address and serially clock out sequential data words. When the memory address limit is reached, the data word address will “roll over” and the sequential read will continue. The sequential read operation is terminated when the microcontroller does not respond with a “0” but does generate a following stop condition (see Figure 12 on page 11).

Figure 7. Device Address

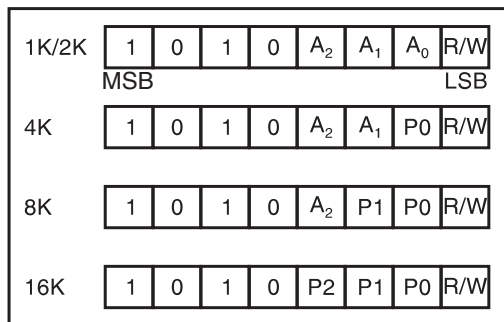

**Figure 8. Byte Write**

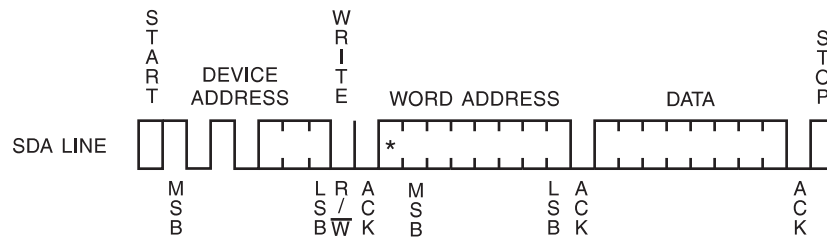

**Figure 9. Page Write**

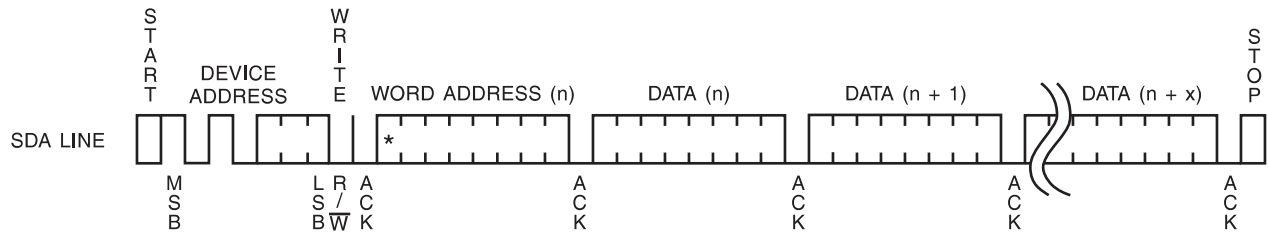

(\* = DON'T CARE bit for 1K)

**Figure 10. Current Address Read**

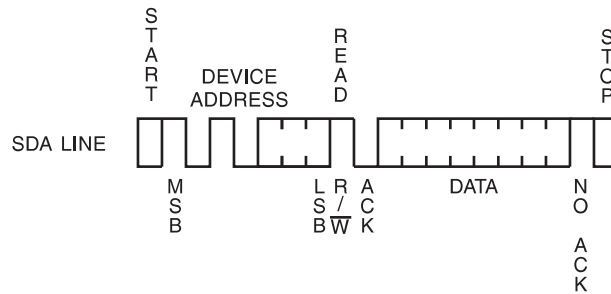
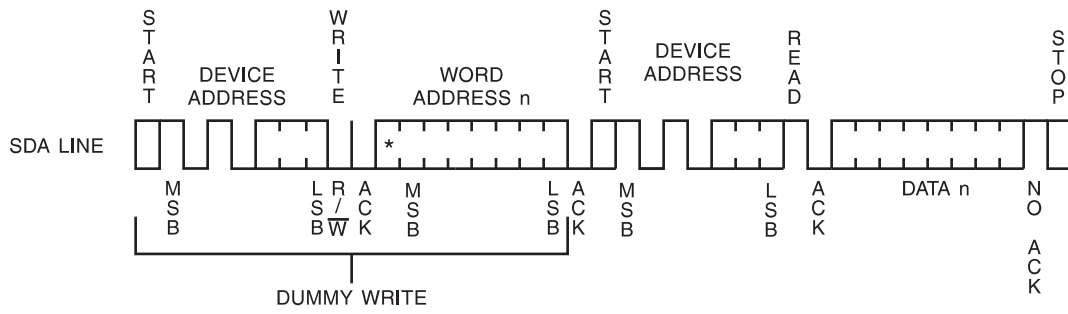
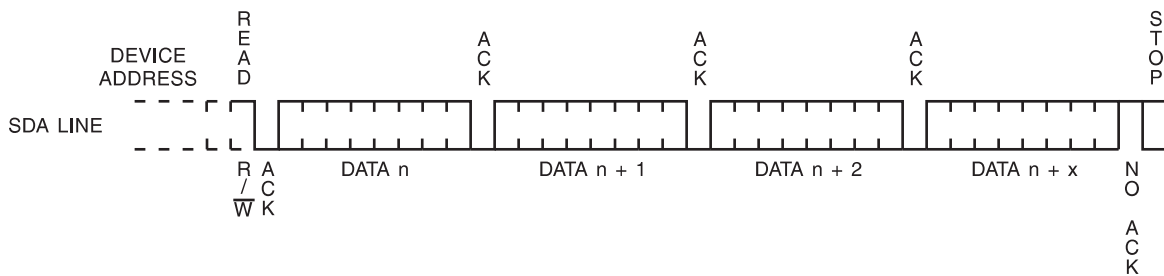

Figure 11. Random Read



(\* = DON'T CARE bit for 1K)

Figure 12. Sequential Read





## AT24C01A Ordering Information<sup>(1)</sup>

| Ordering Code     | Package | Operation Range  |
|-------------------|---------|--|
| AT24C01A-10SQ-2.7 | 8S1     | Lead-free/Halogen-free/Automotive<br>Temperature<br>(-40°C to 125°C) |
| AT24C01A-10TQ-2.7 | 8A2     |  |

Note: 1. This device is not recommended for new design. Please refer to AT24C01B Automotive datasheet.

| Package Type |   |
|--------------|---|
| <b>8S1</b>   | 8-lead, 0.150" Wide, Plastic Gull Wing Small Outline (JEDEC SOIC) |
| <b>8A2</b>   | 8-lead, 0.170" Wide, Thin Shrink Small Outline Package (TSSOP)    |
| Options      |   |
| <b>-2.7</b>  | Low-voltage (2.7V to 5.5V)  |

**AT24C02 Ordering Information<sup>(1)</sup>**

| Ordering Code                         | Package    | Operation Range  |
|---------------------------------------|------------|--|
| AT24C02N-10SQ-2.7<br>AT24C02-10TQ-2.7 | 8S1<br>8A2 | Lead-free/Halogen-free/Automotive<br>Temperature<br>(-40°C to 125°C) |

Note: 1. This device is not recommended for new design. Please refer to AT24C02B Automotive datasheet.

| Package Type |   |
|--------------|---|
| <b>8S1</b>   | 8-lead, 0.150" Wide, Plastic Gull Wing Small Outline (JEDEC SOIC) |
| <b>8A2</b>   | 8-lead, 0.170" Wide, Thin Shrink Small Outline Package (TSSOP)    |
| Options      |   |
| <b>-2.7</b>  | Low-voltage (2.7V to 5.5V)  |



## AT24C04 Ordering Information

| Ordering Code                         | Package    | Operation Range  |
|---------------------------------------|------------|--|
| AT24C04N-10SQ-2.7<br>AT24C04-10TQ-2.7 | 8S1<br>8A2 | Lead-free/Halogen-free/Automotive<br>Temperature<br>(-40°C to 125°C) |

| Package Type |   |
|--------------|---|
| <b>8S1</b>   | 8-lead, 0.150" Wide, Plastic Gull Wing Small Outline (JEDEC SOIC) |
| <b>8A2</b>   | 8-lead, 0.170" Wide, Thin Shrink Small Outline Package (TSSOP)    |
| Options      |   |
| <b>-2.7</b>  | Low-voltage (2.7V to 5.5V)  |

### AT24C08A Ordering Information

| Ordering Code                           | Package    | Operation Range   |
|---|------------|---|
| AT24C08AN-10SQ-2.7<br>AT24C08A-10TQ-2.7 | 8S1<br>8A2 | Lead-free/Halogen-free/<br>Automotive Temperature<br>(-40°C to 125°C) |

Note: For 2.7V devices used in the 4.5V to 5.5V range, please refer to performance values in the AC and DC characteristics tables (Table 4 on page 4 and Table 5 on page 5).

| Package Type |   |
|--------------|---|
| <b>8S1</b>   | 8-lead, 0.150" Wide, Plastic Gull Wing Small Outline (JEDEC SOIC) |
| <b>8A2</b>   | 8-lead, 0.170" Wide, Thin Shrink Small Outline Package (TSSOP)    |
| Options      |   |
| <b>-2.7</b>  | Low Voltage (2.7V to 5.5V)  |



## AT24C16A Ordering Information

| Ordering Code      | Package | Operation Range   |
|--------------------|---------|---|
| AT24C16AN-10SQ-2.7 | 8S1     | Lead-free/Halogen-free/<br>Automotive Temperature<br>(-40°C to 125°C) |
| AT24C16A-10TQ-2.7  | 8A2     |   |

- Notes:
1. For 2.7V devices used in the 4.5V to 5.5V range, please refer to performance values in the AC and DC characteristics tables (Table 4 on page 4 and Table 5 on page 5).
  2. AT24C16A not recommended for new design; replaced by AT24C16C Automotive.

| Package Type |   |
|--------------|---|
| <b>8S1</b>   | 8-lead, 0.150" Wide, Plastic Gull Wing Small Outline (JEDEC SOIC) |
| <b>8A2</b>   | 8-lead, 0.170" Wide, Thin Shrink Small Outline Package (TSSOP)    |
| Options      |   |
| <b>-2.7</b>  | Low Voltage (2.7V to 5.5V)  |



Packaging Information

8S1 – JEDEC SOIC

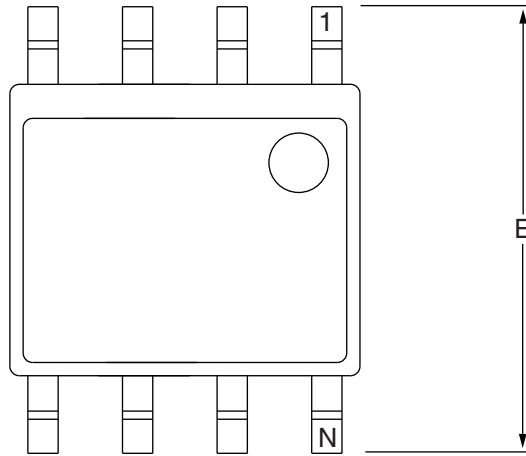

Top View

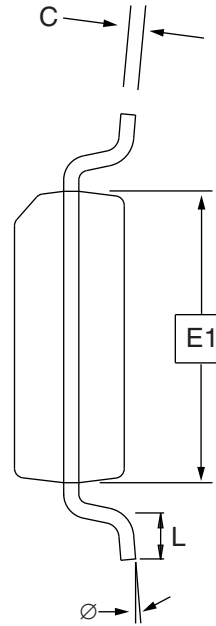

End View

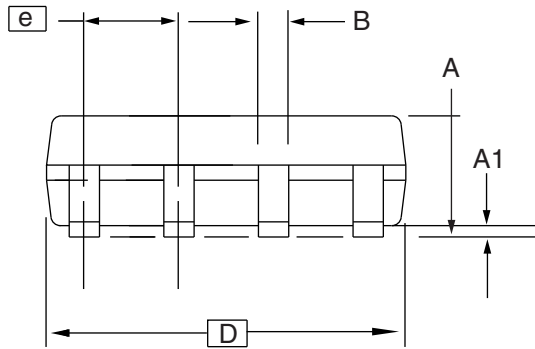

Side View

COMMON DIMENSIONS  
(Unit of Measure = mm)

| SYMBOL | MIN      | NOM | MAX  | NOTE |
|--------|----------|-----|------|------|
| A      | 1.35     | –   | 1.75 |      |
| A1     | 0.10     | –   | 0.25 |      |
| b      | 0.31     | –   | 0.51 |      |
| C      | 0.17     | –   | 0.25 |      |
| D      | 4.80     | –   | 5.00 |      |
| E1     | 3.81     | –   | 3.99 |      |
| E      | 5.79     | –   | 6.20 |      |
| e      | 1.27 BSC |     |      |      |
| L      | 0.40     | –   | 1.27 |      |
| ∅      | 0°       | –   | 8°   |      |

Note: These drawings are for general information only. Refer to JEDEC Drawing MS-012, Variation AA for proper dimensions, tolerances, datums, etc.

10/7/03



1150 E. Cheyenne Mtn. Blvd.  
Colorado Springs, CO 80906

**TITLE**  
8S1, 8-lead (0.150" Wide Body), Plastic Gull Wing  
Small Outline (JEDEC SOIC)

**DRAWING NO.**  
8S1

**REV.**  
B



# 8A2 – TSSOP

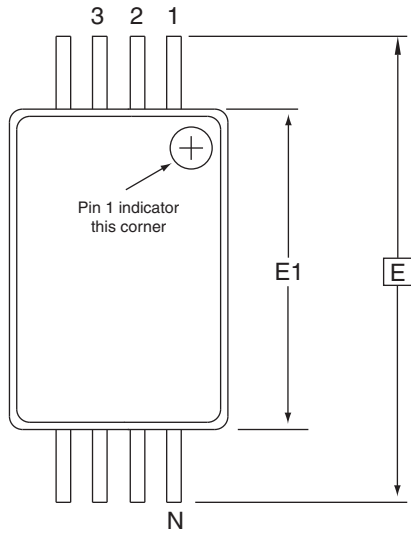

Top View

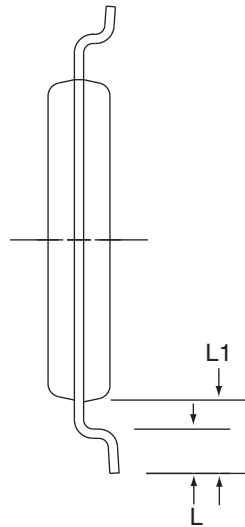

End View

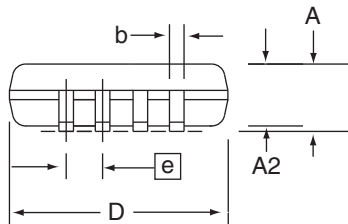

Side View

**COMMON DIMENSIONS**  
(Unit of Measure = mm)

| SYMBOL | MIN      | NOM  | MAX  | NOTE |
|--------|----------|------|------|------|
| D      | 2.90     | 3.00 | 3.10 | 2, 5 |
| E      | 6.40 BSC |      |      |      |
| E1     | 4.30     | 4.40 | 4.50 | 3, 5 |
| A      | –        | –    | 1.20 |      |
| A2     | 0.80     | 1.00 | 1.05 |      |
| b      | 0.19     | –    | 0.30 | 4    |
| e      | 0.65 BSC |      |      |      |
| L      | 0.45     | 0.60 | 0.75 |      |
| L1     | 1.00 REF |      |      |      |

- Notes:
1. This drawing is for general information only. Refer to JEDEC Drawing MO-153, Variation AA, for proper dimensions, tolerances, datums, etc.
  2. Dimension D does not include mold Flash, protrusions or gate burrs. Mold Flash, protrusions and gate burrs shall not exceed 0.15 mm (0.006 in) per side.
  3. Dimension E1 does not include inter-lead Flash or protrusions. Inter-lead Flash and protrusions shall not exceed 0.25 mm (0.010 in) per side.
  4. Dimension b does not include Dambar protrusion. Allowable Dambar protrusion shall be 0.08 mm total in excess of the b dimension at maximum material condition. Dambar cannot be located on the lower radius of the foot. Minimum space between protrusion and adjacent lead is 0.07 mm.
  5. Dimension D and E1 to be determined at Datum Plane H.

5/30/02



2325 Orchard Parkway  
San Jose, CA 95131

**TITLE**  
**8A2**, 8-lead, 4.4 mm Body, Plastic  
Thin Shrink Small Outline Package (TSSOP)

**DRAWING NO.**  
8A2

**REV.**  
B

## Revision History

| Doc. Rev. | Date   | Comments  |
|-----------|--------|---|
| 5092D     | 8/2012 | AT24C16A not recommended for new design; replaced by AT24C16C Automotive.   |
| 5092D     | 4/2007 | Added 'Not recommended for new design' notes to AT24C01A and AT24C02 on pages 1, 12 and 13.   |
| 5092C     | 2/2007 | Implemented revision history.<br>Removed PDIP offering and parts.<br>Added 'AT24C02 Not Recommended for New Design' note to page 1. |



## Atmel Corporation

2325 Orchard Parkway  
San Jose, CA 95131, USA  
Tel: 1(408) 441-0311  
Fax: 1(408) 487-2600

## Regional Headquarters

### Europe

Atmel Sarl  
Route des Arsenalux 41  
Case Postale 80  
CH-1705 Fribourg  
Switzerland  
Tel: (41) 26-426-5555  
Fax: (41) 26-426-5500

### Asia

Room 1219  
Chinachem Golden Plaza  
77 Mody Road Tsimshatsui  
East Kowloon  
Hong Kong  
Tel: (852) 2721-9778  
Fax: (852) 2722-1369

### Japan

9F, Tonetsu Shinkawa Bldg.  
1-24-8 Shinkawa  
Chuo-ku, Tokyo 104-0033  
Japan  
Tel: (81) 3-3523-3551  
Fax: (81) 3-3523-7581

## Atmel Operations

### Memory

2325 Orchard Parkway  
San Jose, CA 95131, USA  
Tel: 1(408) 441-0311  
Fax: 1(408) 436-4314

### Microcontrollers

2325 Orchard Parkway  
San Jose, CA 95131, USA  
Tel: 1(408) 441-0311  
Fax: 1(408) 436-4314

La Chantrerie  
BP 70602  
44306 Nantes Cedex 3, France  
Tel: (33) 2-40-18-18-18  
Fax: (33) 2-40-18-19-60

### ASIC/ASSP/Smart Cards

Zone Industrielle  
13106 Rousset Cedex, France  
Tel: (33) 4-42-53-60-00  
Fax: (33) 4-42-53-60-01

1150 East Cheyenne Mtn. Blvd.  
Colorado Springs, CO 80906, USA  
Tel: 1(719) 576-3300  
Fax: 1(719) 540-1759

Scottish Enterprise Technology Park  
Maxwell Building  
East Kilbride G75 0QR, Scotland  
Tel: (44) 1355-803-000  
Fax: (44) 1355-242-743

### RF/Automotive

Theresienstrasse 2  
Postfach 3535  
74025 Heilbronn, Germany  
Tel: (49) 71-31-67-0  
Fax: (49) 71-31-67-2340

1150 East Cheyenne Mtn. Blvd.  
Colorado Springs, CO 80906, USA  
Tel: 1(719) 576-3300  
Fax: 1(719) 540-1759

### Biometrics/Imaging/Hi-Rel MPU/ High Speed Converters/RF Datacom

Avenue de Rochepleine  
BP 123  
38521 Saint-Egreve Cedex, France  
Tel: (33) 4-76-58-30-00  
Fax: (33) 4-76-58-34-80

---

### Literature Requests

[www.atmel.com/literature](http://www.atmel.com/literature)

**Disclaimer:** The information in this document is provided in connection with Atmel products. No license, express or implied, by estoppel or otherwise, to any intellectual property right is granted by this document or in connection with the sale of Atmel products. **EXCEPT AS SET FORTH IN ATMEL'S TERMS AND CONDITIONS OF SALE LOCATED ON ATMEL'S WEB SITE, ATMEL ASSUMES NO LIABILITY WHATSOEVER AND DISCLAIMS ANY EXPRESS, IMPLIED OR STATUTORY WARRANTY RELATING TO ITS PRODUCTS INCLUDING, BUT NOT LIMITED TO, THE IMPLIED WARRANTY OF MERCHANTABILITY, FITNESS FOR A PARTICULAR PURPOSE, OR NON-INFRINGEMENT. IN NO EVENT SHALL ATMEL BE LIABLE FOR ANY DIRECT, INDIRECT, CONSEQUENTIAL, PUNITIVE, SPECIAL OR INCIDENTAL DAMAGES (INCLUDING, WITHOUT LIMITATION, DAMAGES FOR LOSS OF PROFITS, BUSINESS INTERRUPTION, OR LOSS OF INFORMATION) ARISING OUT OF THE USE OR INABILITY TO USE THIS DOCUMENT, EVEN IF ATMEL HAS BEEN ADVISED OF THE POSSIBILITY OF SUCH DAMAGES.** Atmel makes no representations or warranties with respect to the accuracy or completeness of the contents of this document and reserves the right to make changes to specifications and product descriptions at any time without notice. Atmel does not make any commitment to update the information contained herein. Unless specifically provided otherwise, Atmel products are not suitable for, and shall not be used in, automotive applications. Atmel's products are not intended, authorized, or warranted for use as components in applications intended to support or sustain life.

© 2007 Atmel Corporation. **All rights reserved.** Atmel®, logo and combinations thereof, and others, are registered trademarks or trademarks of Atmel Corporation or its subsidiaries. Other terms and product names may be trademarks of others.



Printed on recycled paper.

5092D-SEEPR-4/07