

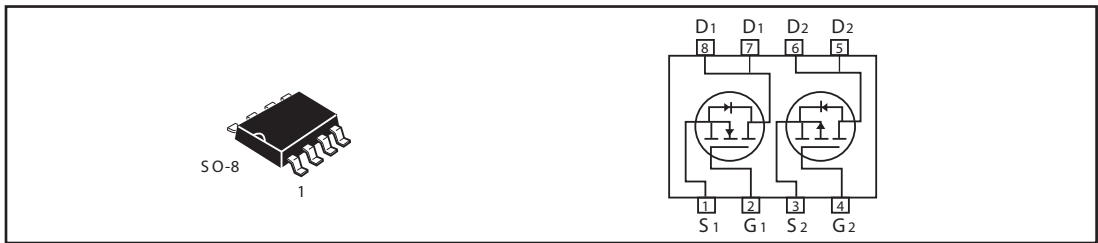

## Dual Enhancement Mode Field Effect Transistor ( N and P Channel)

PRODUCT SUMMARY (N-Channel)		
V <sub>DSS</sub>	I <sub>D</sub>	R <sub>DS(ON)</sub> ( mΩ ) Max
30V	7A	25 @ V <sub>GS</sub> = 10V
		40 @ V <sub>GS</sub> = 4.5V

PRODUCT SUMMARY (P-Channel)		
V <sub>DSS</sub>	I <sub>D</sub>	R <sub>DS(ON)</sub> ( mΩ ) Max
-30V	-5A	45 @ V <sub>GS</sub> = -10V
		60 @ V <sub>GS</sub> = -4.5V



### ABSOLUTE MAXIMUM RATINGS (T<sub>A</sub>=25°C unless otherwise noted)

Parameter		Symbol	N-Channel	P-Channel	Unit
Drain-Source Voltage		V <sub>DS</sub>	30	-30	V
Gate-Source Voltage		V <sub>GS</sub>	±22	±22	V
Drain Current-Continuous <sup>a</sup> @ T <sub>a</sub>	25°C	I <sub>D</sub>	7	-5	A
	70°C		6	-4.5	A
-Pulsed <sup>b</sup>		I <sub>DM</sub>	29	-20	A
Drain-Source Diode Forward Current <sup>a</sup>		I <sub>S</sub>	1.7	-1.7	A
Maximum Power Dissipation <sup>a</sup>	T <sub>a</sub> =25°C	P <sub>D</sub>	2		W
	T <sub>a</sub> =70°C		1.44		
Operating Junction and Storage Temperature Range		T <sub>J</sub> , T <sub>STG</sub>	-55 to 150		°C

### THERMAL CHARACTERISTICS

Thermal Resistance, Junction-to-Ambient <sup>a</sup>	R <sub>θJA</sub>	62.5	°C/W
--	------------------	------	------

# STM8405

N-Channel ELECTRICAL CHARACTERISTICS ( $T_A = 25\text{ }^{\circ}\text{C}$  unless otherwise noted)

Parameter	Symbol	Condition	Min	Typ <sup>c</sup>	Max	Unit
<b>OFF CHARACTERISTICS</b>						
Drain-Source Breakdown Voltage	$BV_{DSS}$	$V_{GS} = 0V, I_D = 250\mu A$	30			V
Zero Gate Voltage Drain Current	$I_{DSS}$	$V_{DS} = 24V, V_{GS} = 0V$			1	$\mu A$
Gate-Body Leakage	$I_{GSS}$	$V_{GS} = \pm 22V, V_{DS} = 0V$			$\pm 100$	nA
<b>ON CHARACTERISTICS<sup>b</sup></b>						
Gate Threshold Voltage	$V_{GS(th)}$	$V_{DS} = V_{GS}, I_D = 250\mu A$	1	1.5	2	V
Drain-Source On-State Resistance	$R_{DS(ON)}$	$V_{GS} = 10V, I_D = 6.6A$		20	25	m ohm
		$V_{GS} = 4.5V, I_D = 5A$		35	40	m ohm
On-State Drain Current	$I_{D(ON)}$	$V_{DS} = 5V, V_{GS} = 4.5V$	20			A
Forward Transconductance	$g_{FS}$	$V_{DS} = 5V, I_D = 6.6A$		10		S
<b>DYNAMIC CHARACTERISTICS<sup>c</sup></b>						
Input Capacitance	$C_{ISS}$	$V_{DS} = 15V, V_{GS} = 0V$ $f = 1.0MHz$		765	865	pF
Output Capacitance	$C_{OSS}$			145	160	pF
Reverse Transfer Capacitance	$C_{RSS}$			96	113	pF
Gate resistance	$R_g$	$V_{GS} = 0V, V_{DS} = 0V, f = 1.0MHz$		3		ohm
<b>SWITCHING CHARACTERISTICS<sup>c</sup></b>						
Turn-On Delay Time	$t_{D(ON)}$	$V_{DD} = 15V$ $I_D = 6.6A$ $V_{GS} = 10V$ $R_{GEN} = 3\text{ ohm}$		7.4	8.5	ns
Rise Time	$t_r$			27.7	32	ns
Turn-Off Delay Time	$t_{D(OFF)}$			12.2	14	ns
Fall Time	$t_f$			7.6	9	ns
Total Gate Charge	$Q_g$	$V_{DS} = 15V, I_D = 6.6A, V_{GS} = 10V$		14.1	16	nC
		$V_{DS} = 15V, I_D = 6.6A, V_{GS} = 4.5V$		6.2	7	nC
Gate-Source Charge	$Q_{gs}$	$V_{DS} = 15V, I_D = 6.6A$		2.2	2.6	nC
Gate-Drain Charge	$Q_{gd}$	$V_{GS} = 10V$		4.1	4.8	nC

# STM8405

P-Channel ELECTRICAL CHARACTERISTICS ( $T_A = 25\text{ }^{\circ}\text{C}$  unless otherwise noted)

Parameter	Symbol	Condition	Min	Typ <sup>c</sup>	Max	Unit
<b>OFF CHARACTERISTICS</b>						
Drain-Source Breakdown Voltage	$BV_{DSS}$	$V_{GS} = 0V, I_D = -250\mu A$	-30			V
Zero Gate Voltage Drain Current	$I_{DSS}$	$V_{DS} = -24V, V_{GS} = 0V$			-1	$\mu A$
Gate-Body Leakage	$I_{GSS}$	$V_{GS} = \pm 22V, V_{DS} = 0V$			$\pm 100$	nA
<b>ON CHARACTERISTICS<sup>b</sup></b>						
Gate Threshold Voltage	$V_{GS(th)}$	$V_{DS} = V_{GS}, I_D = -250\mu A$	-1	-1.5	-2.5	V
Drain-Source On-State Resistance	$R_{DS(ON)}$	$V_{GS} = -10V, I_D = -5A$		35	45	m ohm
		$V_{GS} = -4.5V, I_D = -4A$		50	60	m ohm
On-State Drain Current	$I_{D(ON)}$	$V_{DS} = -5V, V_{GS} = -10V$	20			A
Forward Transconductance	$g_{FS}$	$V_{DS} = -5V, I_D = -5A$		9		S
<b>DYNAMIC CHARACTERISTICS<sup>c</sup></b>						
Input Capacitance	$C_{ISS}$	$V_{DS} = -15V, V_{GS} = 0V$ $f = 1.0MHz$		721	820	pF
Output Capacitance	$C_{OSS}$			154	180	pF
Reverse Transfer Capacitance	$C_{RSS}$			92	108	pF
Gate resistance	$R_g$	$V_{GS} = 0V, V_{DS} = 0V, f = 1.0MHz$		3.3		ohm
<b>SWITCHING CHARACTERISTICS<sup>c</sup></b>						
Turn-On Delay Time	$t_{D(ON)}$	$V_{DD} = -15V$ $R_L = 2.7\text{ ohm}$ $V_{GS} = -10V$ $R_{GEN} = 3\text{ ohm}$		4.7	5.5	ns
Rise Time	$t_r$			7.8	9	ns
Turn-Off Delay Time	$t_{D(OFF)}$			47.2	56	ns
Fall Time	$t_f$			22.6	26	ns
Total Gate Charge	$Q_g$	$V_{DS} = -15V, I_D = -5A, V_{GS} = -10V$		13.8	16	nC
		$V_{DS} = -15V, I_D = -5A, V_{GS} = -4.5V$		7.3	8.6	nC
Gate-Source Charge	$Q_{gs}$	$V_{DS} = -15V, I_D = -5A$		1.5	2	nC
Gate-Drain Charge	$Q_{gd}$	$V_{GS} = -10V$		4.3	5	nC

# STM8405

## ELECTRICAL CHARACTERISTICS ( $T_A=25^{\circ}\text{C}$ unless otherwise noted)

Parameter	Symbol	Condition	Min	Typ <sup>c</sup>	Max	Unit
<b>DRAIN-SOURCE DIODE CHARACTERISTICS<sup>b</sup></b>						
Diode Forward Voltage	$V_{SD}$	$V_{GS} = 0\text{V}, I_s = 1.7\text{A}$	N-Ch	0.8	1.2	V
		$V_{GS} = 0\text{V}, I_s = -1.7\text{A}$	P-Ch	-0.78	-1.2	

### Notes

- a. Surface Mounted on FR4 Board,  $t \leq 10\text{sec}$ .
  - b. Pulse Test: Pulse Width  $\leq 300 \mu\text{s}$ , Duty Cycle  $\leq 2\%$ .
  - c. Guaranteed by design, not subject to production testing.
- N-Channel

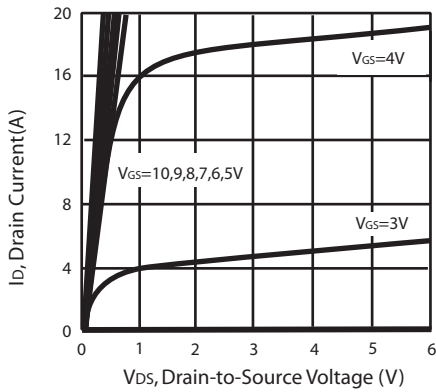

Figure 1. Output Characteristics

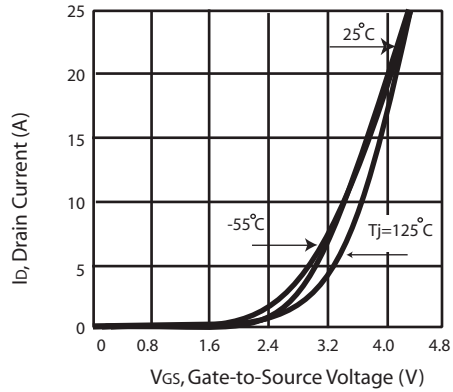

Figure 2. Transfer Characteristics

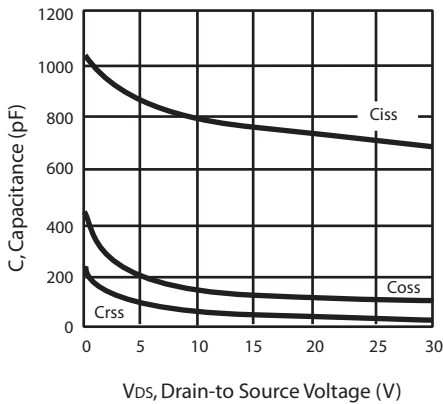

Figure 3. Capacitance

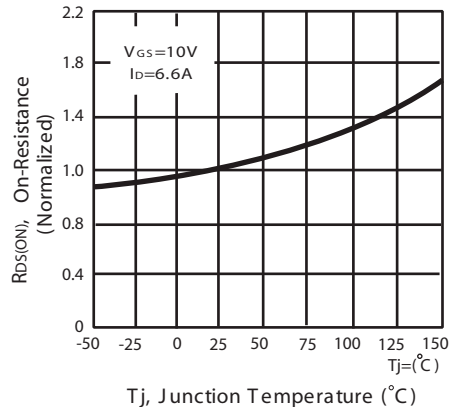

Figure 4. On-Resistance Variation with Drain Current and Temperature

# STM8405

## N-Channel

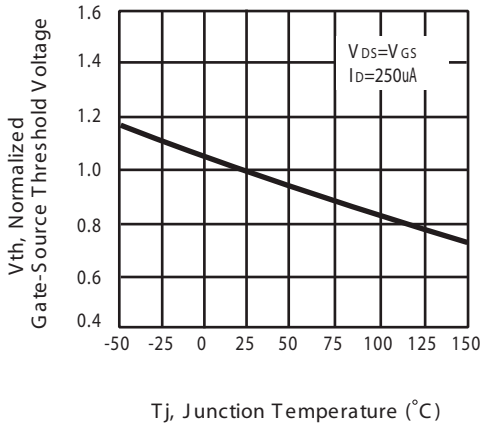

Figure 5. Gate Threshold Variation with Temperature

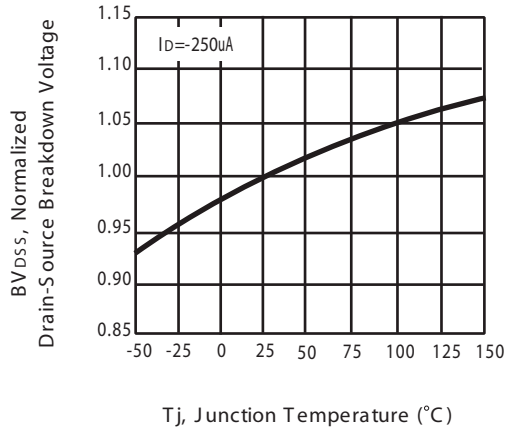

Figure 6. Breakdown Voltage Variation with Temperature

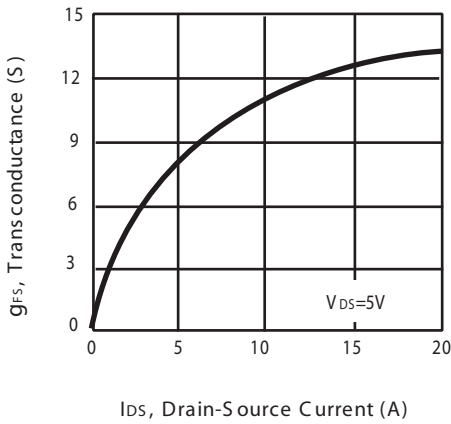

Figure 7. Transconductance Variation with Drain Current

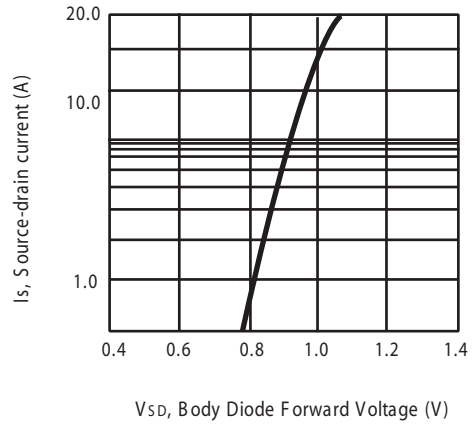

Figure 8. Body Diode Forward Voltage Variation with Source Current

# STM8405

## P-Channel

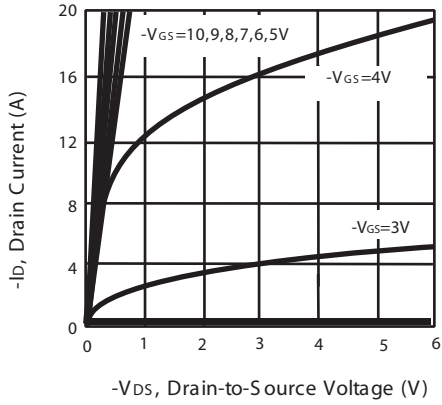

Figure 1. Output Characteristics

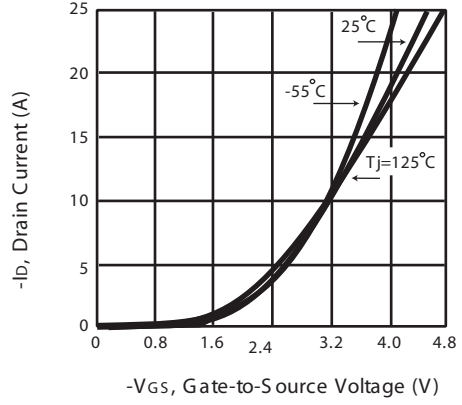

Figure 2. Transfer Characteristics

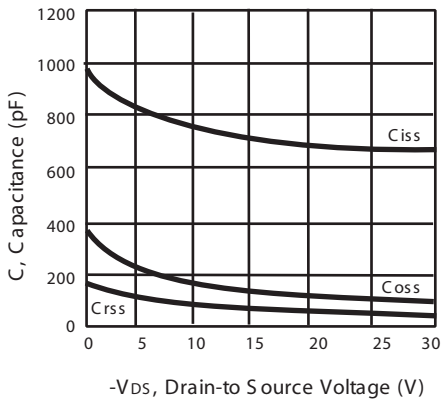

Figure 3. Capacitance

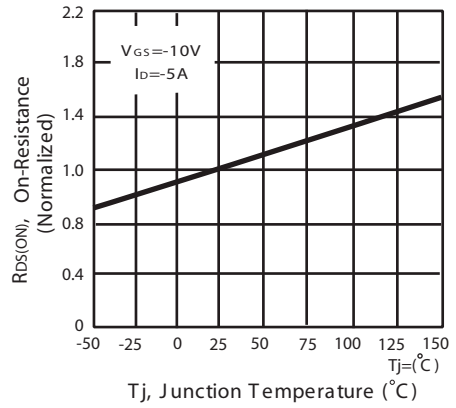

Figure 4. On-Resistance Variation with Temperature

# STM8405

## P-Channel

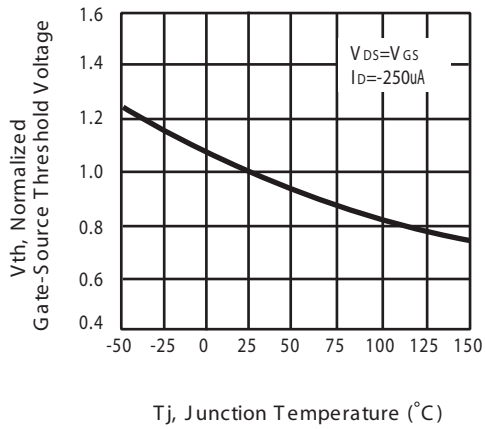

Figure 5. Gate Threshold Variation with Temperature

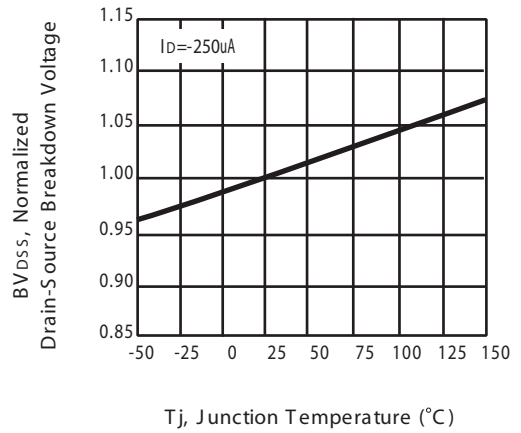

Figure 6. Breakdown Voltage Variation with Temperature

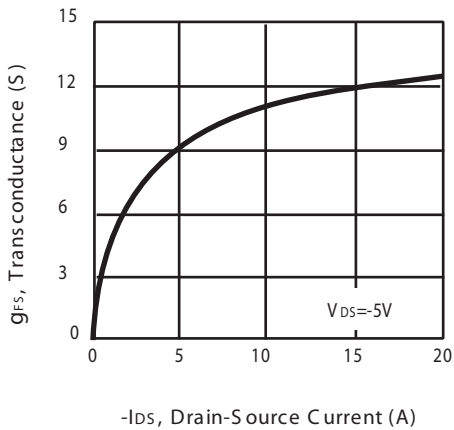

Figure 7. Transconductance Variation with Drain Current

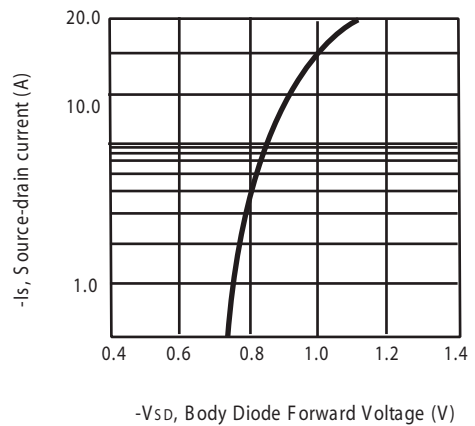
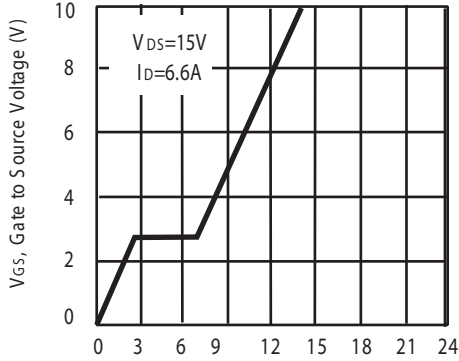

Figure 8. Body Diode Forward Voltage Variation with Source Current

# STM8405

## N-Channel



Qg, Total Gate Charge (nC)  
Figure 9. Gate Charge

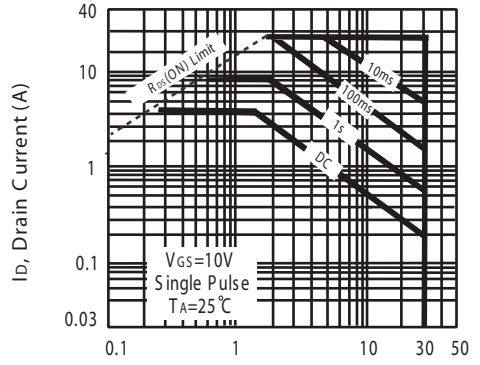

Vds, Drain-Source Voltage (V)  
Figure 10. Maximum Safe Operating Area

## P-Channel

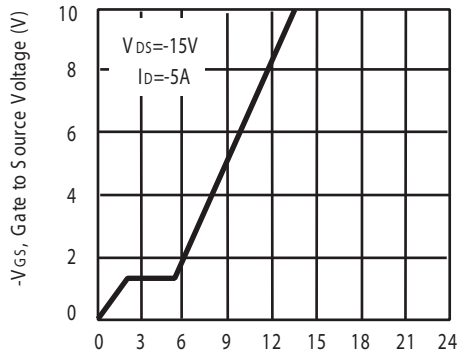

Qg, Total Gate Charge (nC)  
Figure 9. Gate Charge

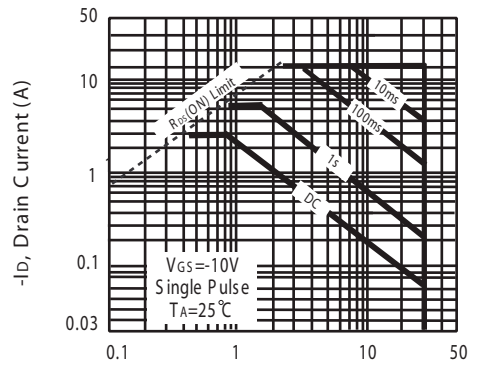

-Vds, Body Diode Forward Voltage (V)  
Figure 10. Maximum Safe Operating Area



# STM8405

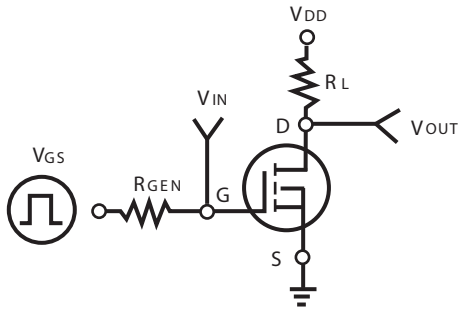

Figure 11. Switching Test Circuit

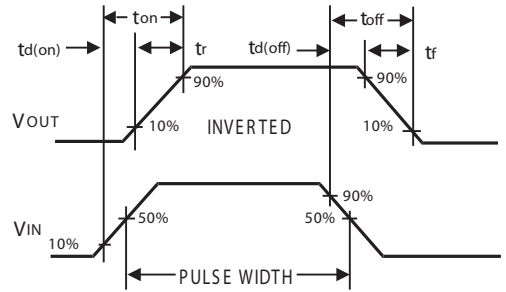
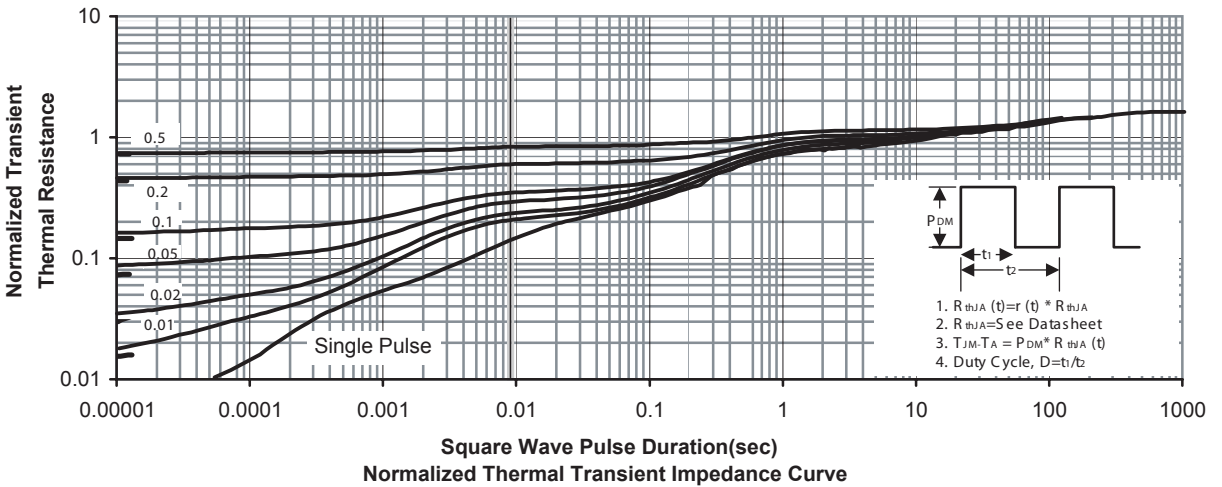
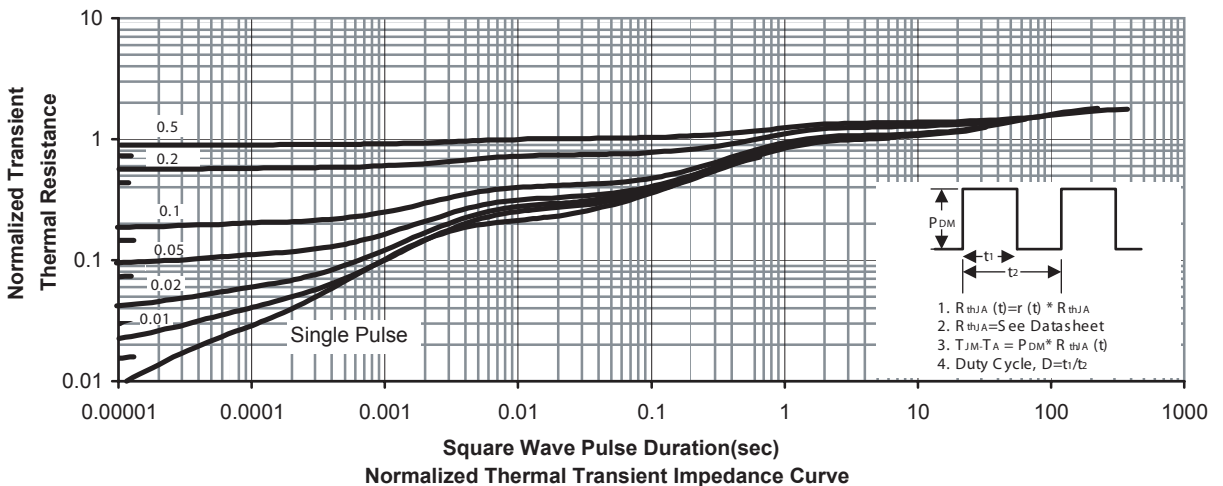

Figure 12. Switching Waveforms

## N-Channel



## P-Channel



# STM8405

## PACKAGE OUTLINE DIMENSIONS

SO-8

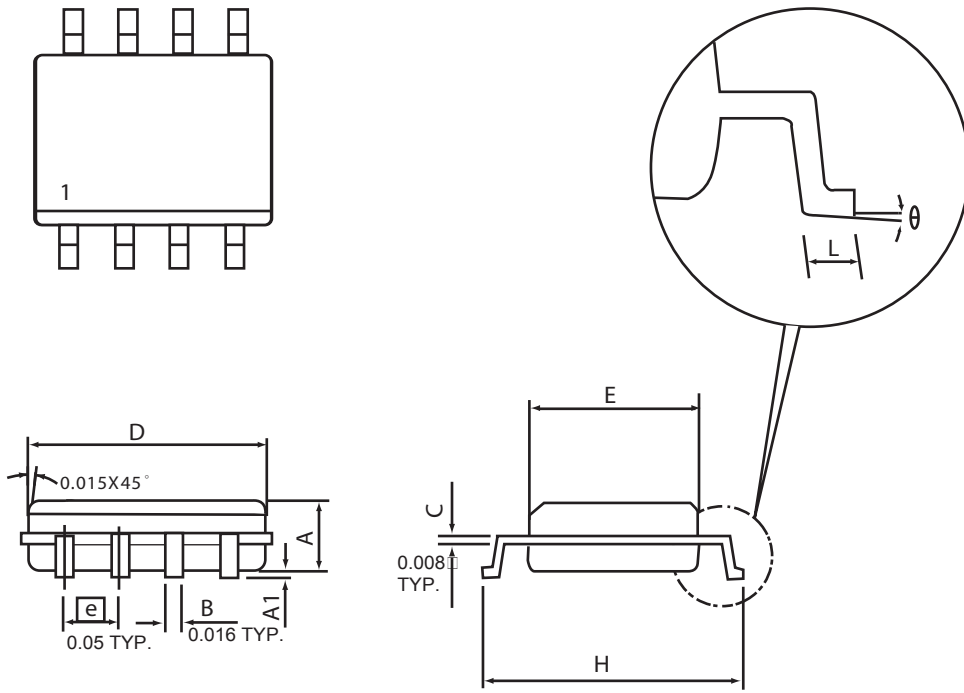

SYMBOLS	MILLIMETERS		INCHES	
	MIN	MAX	MIN	MAX
A	1.35	1.75	0.053	0.069
A1	0.10	0.25	0.004	0.010
D	4.80	4.98	0.189	0.196
E	3.81	3.99	0.150	0.157
H	5.79	6.20	0.228	0.244
L	0.41	1.27	0.016	0.050
$\theta$	0°	8°	0°	8°

# STM8405

## SO-8 Tape and Reel Data

### SO-8 Carrier Tape

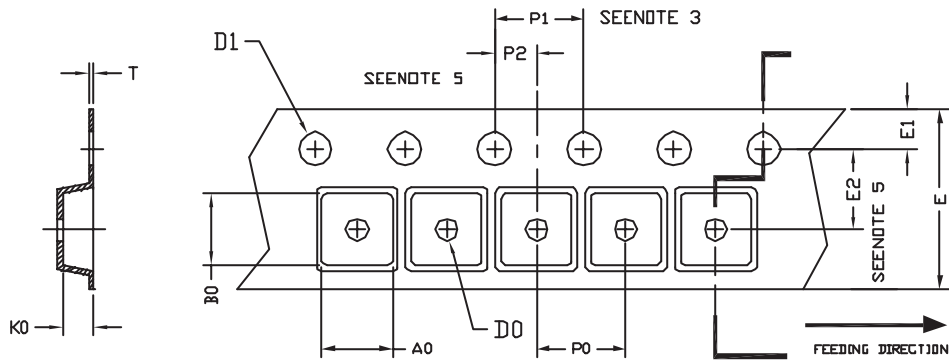

unit:mm

PACKAGE	A0	B0	K0	D0	D1	E	E1	E2	P0	P1	P2	T
SOP 8N 150mil	6.40	5.20	2.10	$\phi 1.5$ (MIN)	$\phi 1.5 \square$ $+ 0.1 \square$ $- 0.0$	$12.0$ $\pm 0.3$	1.75	$5.5 \square$ $\pm 0.05$	8.0	4.0	$2.0 \square$ $\pm 0.05$	$0.3 \square$ $\pm 0.05$

### SO-8 Reel

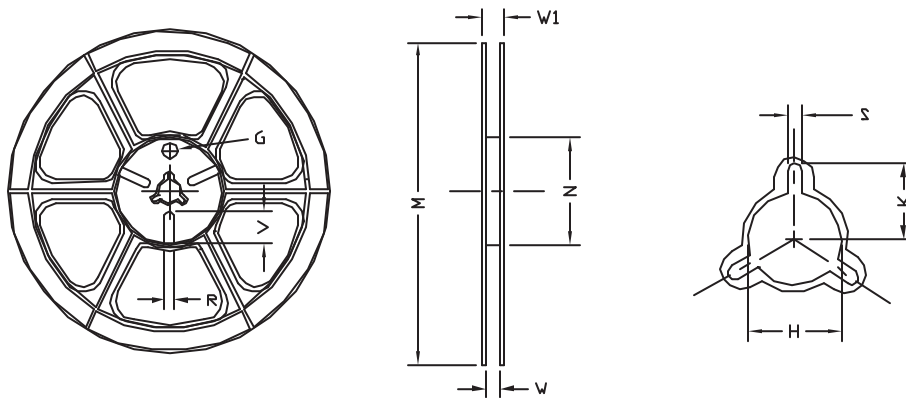

UNIT:mm

TAPE SIZE	REEL SIZE	M	N	W	W1	H	K	S	G	R	V
12 mm	$\phi 330$	$330$ $\pm 1$	$62$ $\pm 1.5$	$12.4 \square$ $+ 0.2$	$16.8 \square$ $- 0.4$	$\phi 12.75$ $+ 0.15$	---	$2.0 \square$ $\pm 0.15$	---	---	---