

WL2851K

High Input Voltage, Low Quiescent Current LDO

[Http://www.sh-willsemi.com](http://www.sh-willsemi.com)

Descriptions

The WL2851K series is a high accuracy, high input voltage low quiescent current, high speed, and low dropout Linear regulator with high ripple rejection. The device is manufactured with Bi-CMOS process.

The WL2851K offers over-current limit and over temperature protection to ensure the device working in well conditions.

The WL2851K regulators are available in standard SOT-89-3L packages. Standard products are Pb-free and Halogen-free.

Features

- Supply Voltage : 4.75V~40V
- Output Range : 1.8V~5.0V
- Output Accuracy : <+/-2%
- Output Current : 30mA (Up to 50mA Typ.)
- PSRR : 60dB @ 100Hz
- Dropout Voltage : 240mV @ I_{OUT}=30mA
- Quiescent Current : 10μA@V_{IN}=7V(Typ.)
- Recommend Capacitor : 10uF



SOT-89

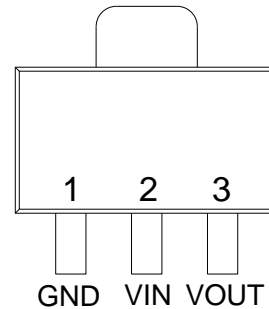

Pin Configuration (Top View)

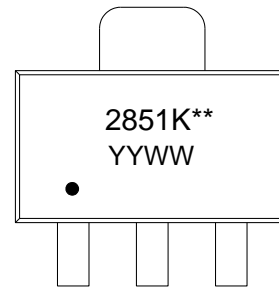

For detail marking information, please see page 8.

Marking

Order Information

For detail order information, please see page 8.

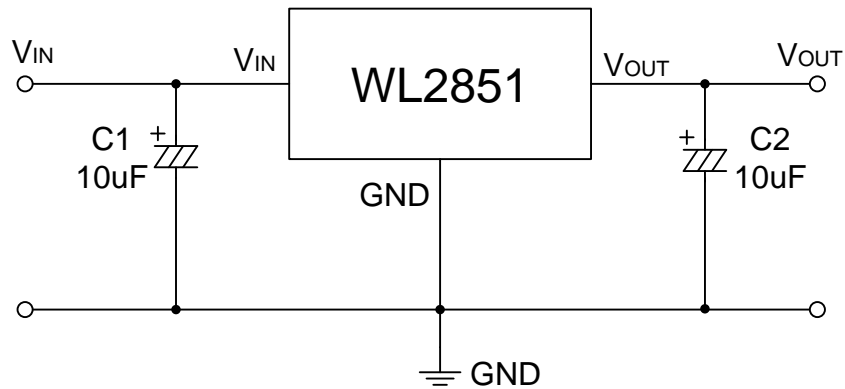
Typical Application

(Locate C_{in} and C_{out} as close to the V_{in} pin and V_{out} pin as possible.)

Pin Description

PIN	Symbol	Description
1	GND	Ground
2	VIN	Voltage Input
3	VOUT	Voltage Output

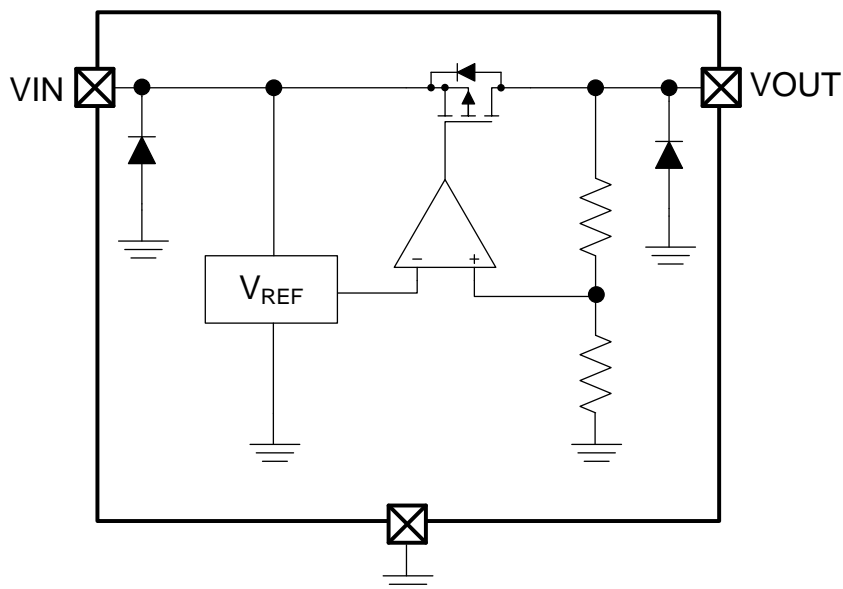
Block Diagram

Absolute Maximum Ratings

Parameter	Value	Unit
Power Dissipation	Internal limited	mW
V _{IN} Range	-0.3~45	V
V _{OUT} Range	-0.3~6.5	V
Lead Temperature Range	260	°C
Storage Temperature Range	-55 ~ 150	°C
Operating Junction Temperature Range	150	°C
ESD MM	400	V
ESD HBM	4K	V

Recommend Operating Ratings

Parameter	Value	Unit
Operating Supply voltage	4.75~40	V
Operating Temperature Range	-40~85	°C
Thermal Resistance, R _{θJA}	150	°C/W

Electronics Characteristics (Ta=25°C, V_{IN}=12V, C_{IN}=C_{OUT}=10uF, unless otherwise noted)

Symbol	Parameter	Test Condition	WL2851K SPEC			Unit
			Min.	Typ.	Max.	
V _{IN}	Input Range	I _{OUT} =10mA	4.75		40	V
V _{OUT}	Output Range	I _{OUT} =10mA	V _{OUT} *0.98	V _{OUT}	V _{OUT} *1.02	V
ΔV _{OUT}	Output Voltage	V _{IN} =12V, I _{OUT} =10mA	4.9	5.0	5.1	V
			3.234	3.3	3.366	V
I _{OUT_PK}	Maximum Output Current	V _{IN} =12V, R _L =1Ω	180	280	460	mA
I _Q	Quiescent Current	V _{IN} =7V, No load		10	15	μA
		V _{IN} =24V, No load		11	16	
		V _{IN} =40V, No load		13	20	
V _{DROP}	Dropout Voltage	I _{OUT} =1mA		8	12	mV
		I _{OUT} =30mA		240	400	
ΔV _{Line}	Line Regulation	V _{IN} =7--24V, V _{OUT} =5V I _{OUT} =1mA		0.02		%V
		V _{IN} =7--45V, V _{OUT} =5V I _{OUT} =1mA		0.1		
ΔV _{Load}	Load Regulation	V _{IN} =12V, I _{OUT} =1--100mA		0.6		%
e _{NO}	Output Noise	I _{OUT} =10mA	-100		+100	μV
PSRR	Ripple Rejection	V _{IN} =10V V _{PP} =0.5V I _{OUT} =1mA	f=100Hz	60		dB
			f=1KHz	45		
			f=10KHz	35		
T _{SD}	Thermal Protection	V _{IN} =12V, I _{OUT} =1mA		165		°C
T _{SD_HYS}	Thermal Protection Hys	V _{IN} =12V, I _{OUT} =1mA		30		°C
ΔVo/ΔT	Temperature Coefficient	V _{IN} =12V, I _{OUT} =1mA		±0.5		mv/°C

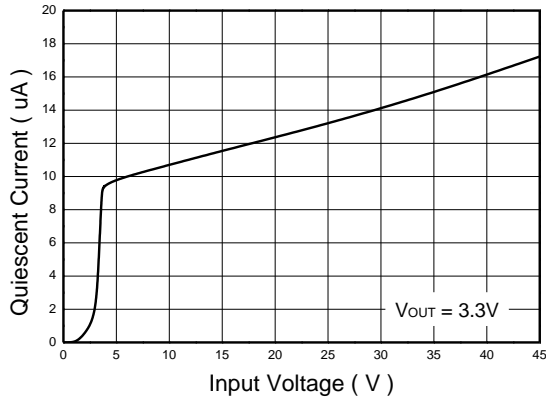
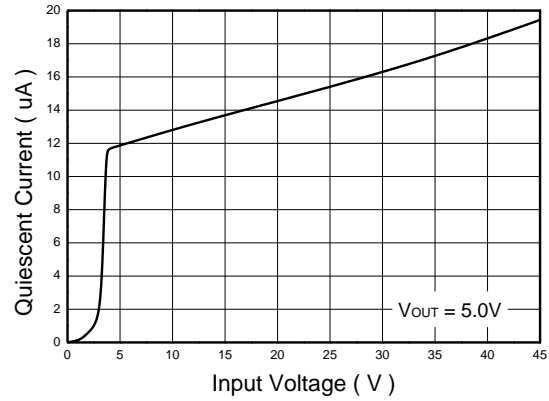
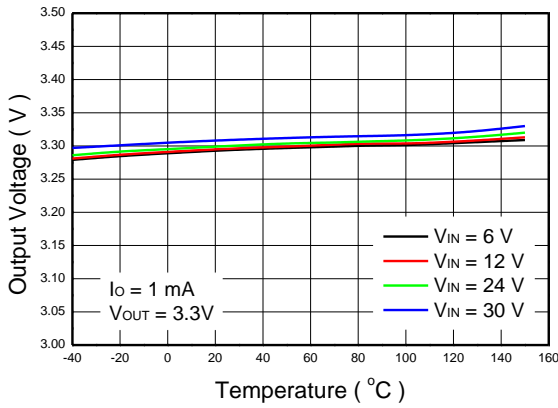
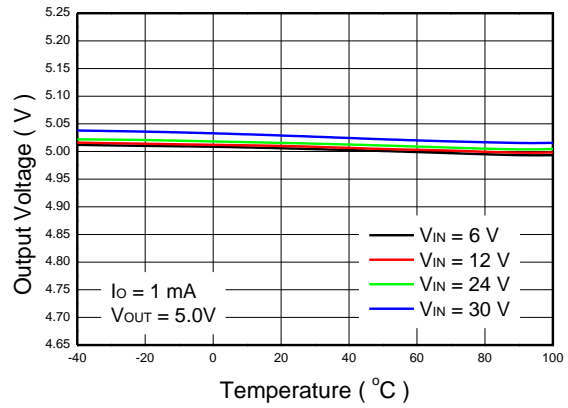
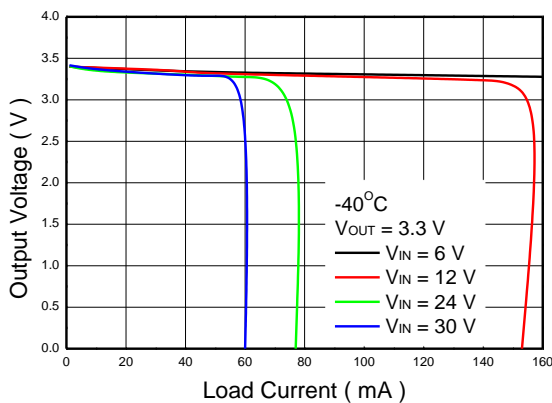
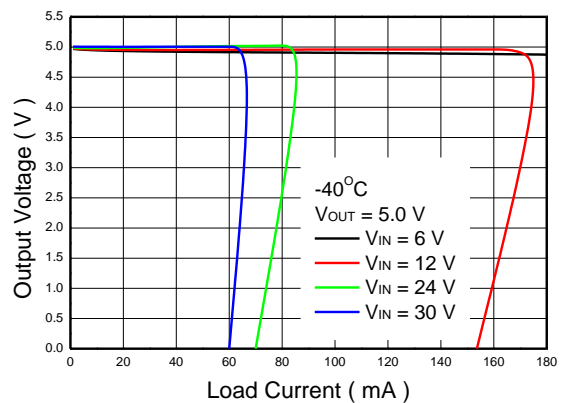
Typical characteristics (Ta=25oC, CIN=COUT=10uF, unless otherwise noted)

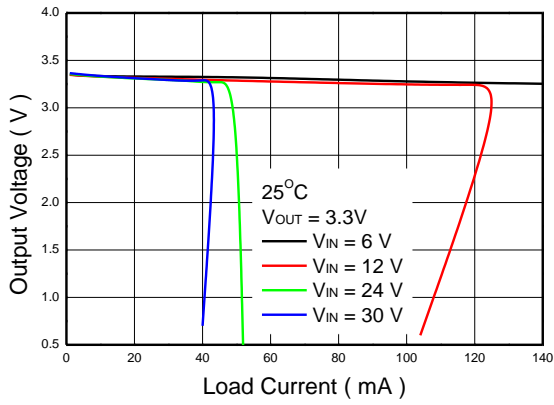
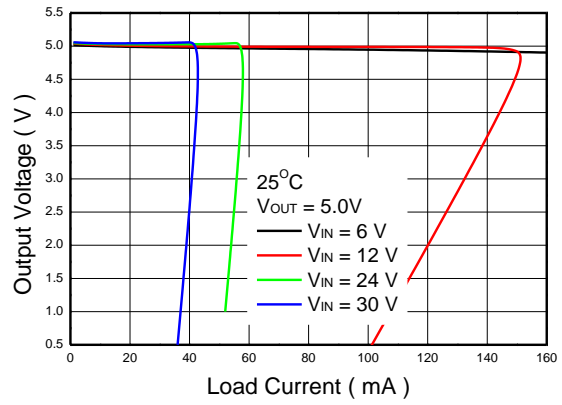
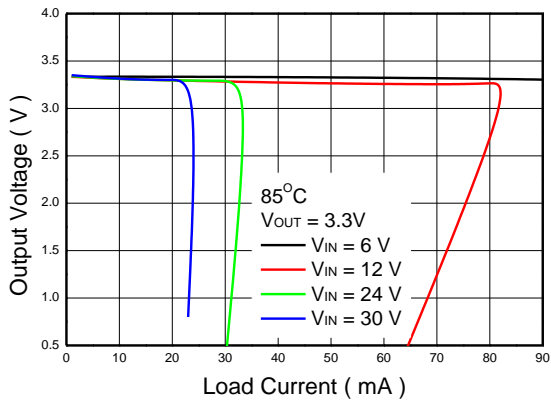
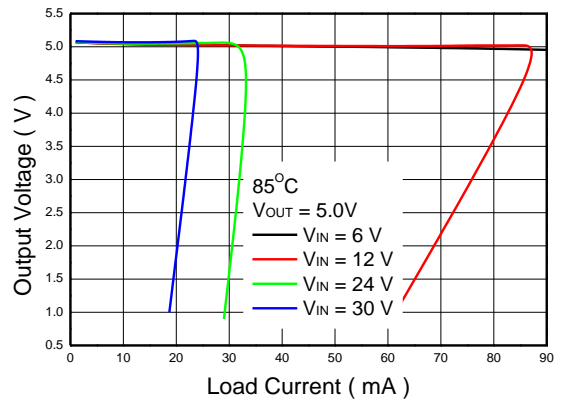
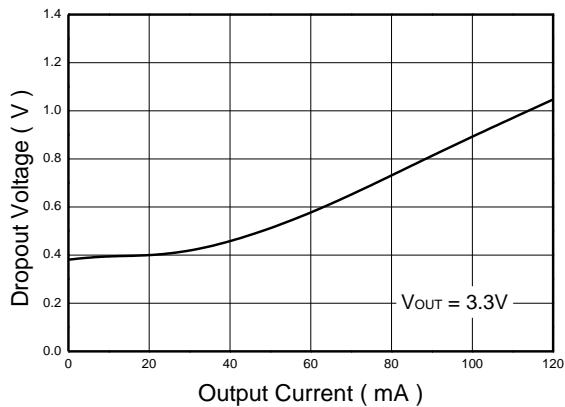
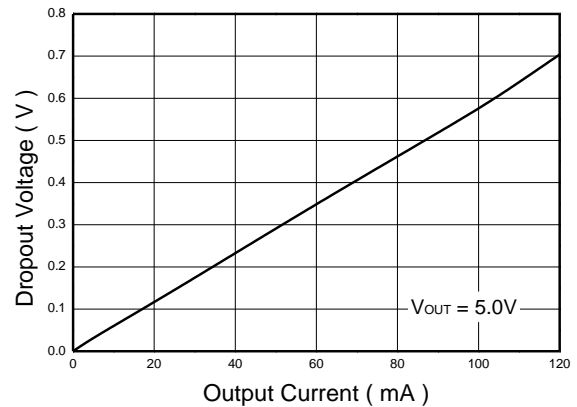
Quiescent Current vs. Input Voltage

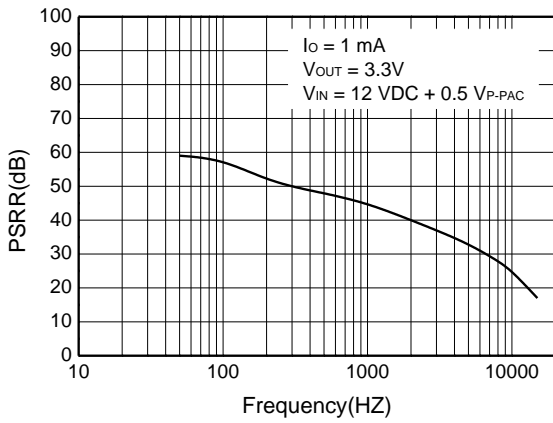
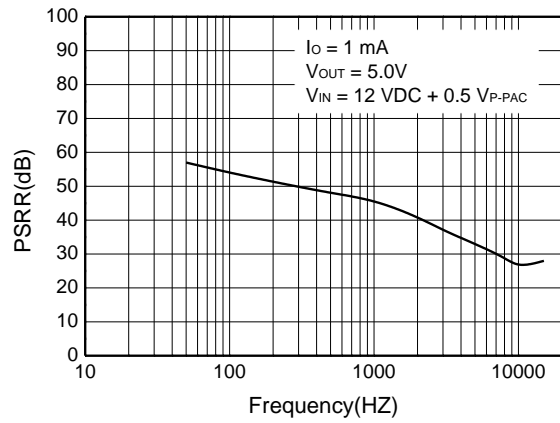
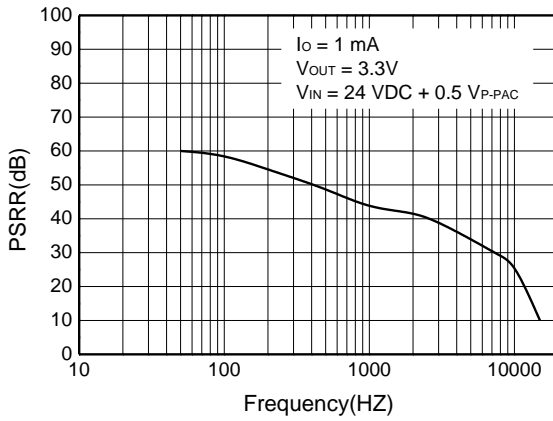
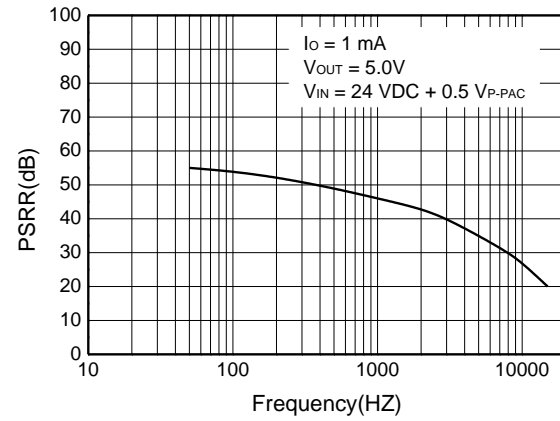
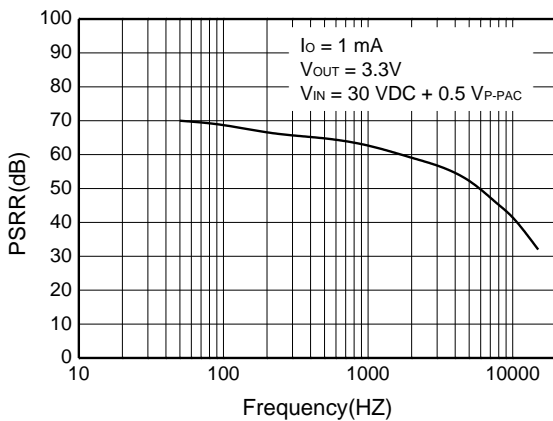
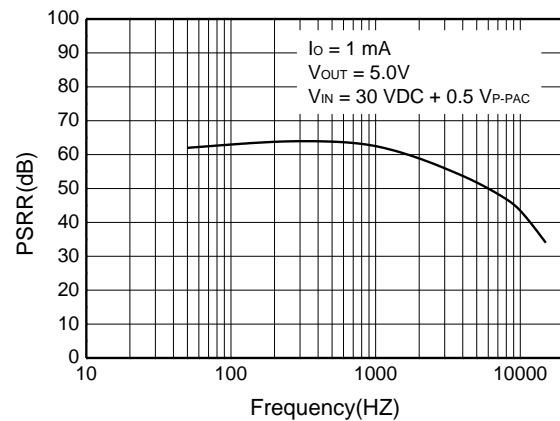
Quiescent Current vs. Input Voltage

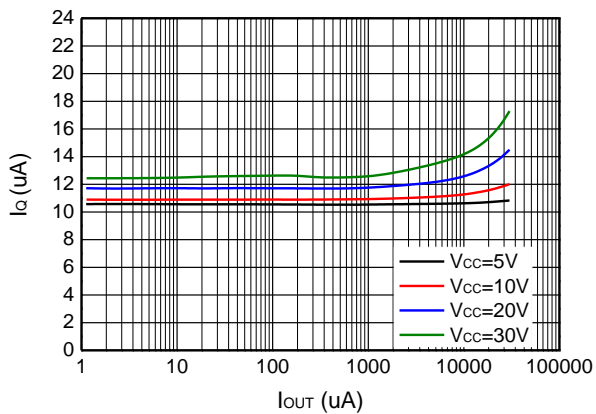
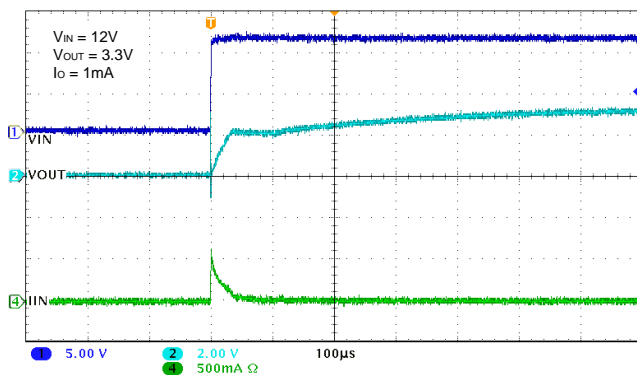
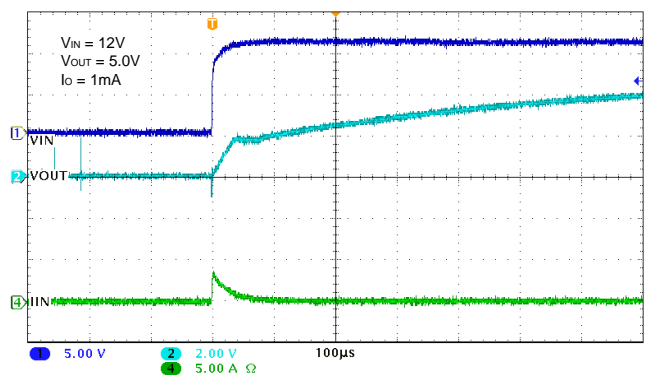
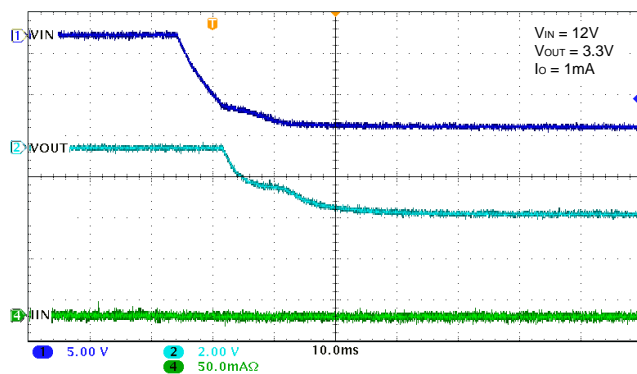
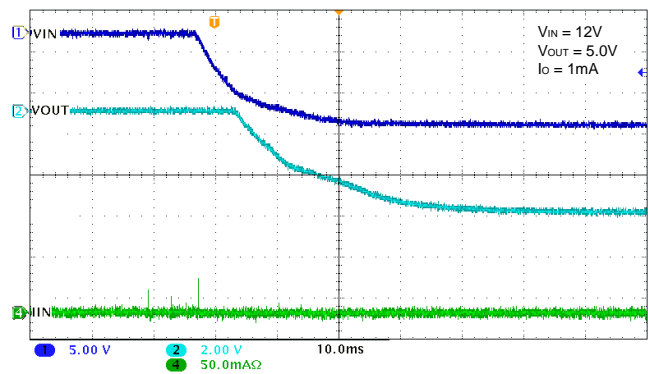
Output Voltage vs. Temperature

Output Voltage vs. Temperature

Output Voltage vs. Load Current

Output Voltage vs. Load Current

Output Voltage vs. Load Current

Output Voltage vs. Load Current

Output Voltage vs. Load Current

Output Voltage vs. Load Current

Dropout Voltage vs. Output Current

Dropout Voltage vs. Output Current

PSRR vs. Frequency

PSRR vs. Frequency

PSRR vs. Frequency

PSRR vs. Frequency

PSRR vs. Frequency

PSRR vs. Frequency

Quiescent Current vs. Output Current

Startup from Power ON

Startup from Power ON

Shutdown from Power OFF

Shutdown from Power OFF

ORDER INFORMATION

Ordering No.	Vout (V)	Package	Operating Temperature	Marking	Shipping
WL2851K33-3/TR	3.3	SOT-89	-40~+85°C	2851K33 YYWW	Tape and Reel, 1000
WL2851K50-3/TR	5.0	SOT-89	-40~+85°C	2851K50 YYWW	Tape and Reel, 1000

Marking:

2851K** = Device Code

YY = Year

WW = Week

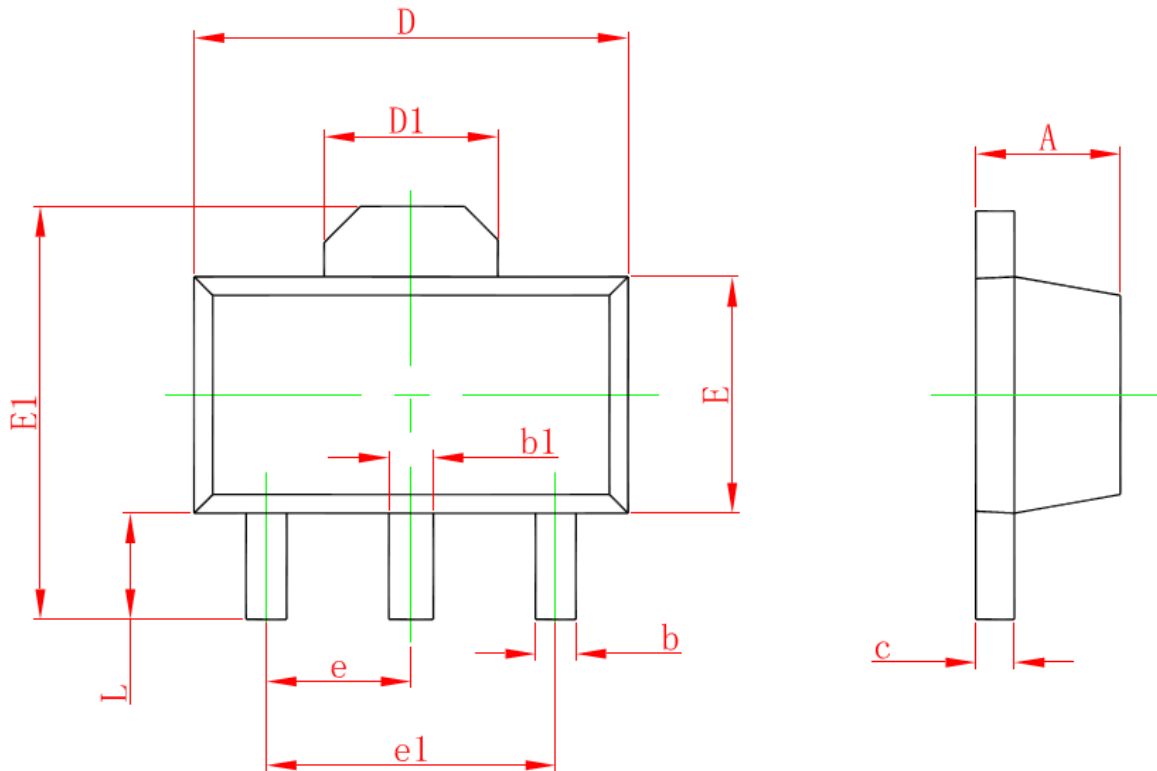
Package outline dimensions
SOT-89-3L

Symbol	Dimensions in millimeter		
	Min.	Typ.	Max.
A	1.40	1.50	1.60
b	0.38	0.42	0.47
b1	0.46	0.49	0.55
c	0.40	-	0.44
D	4.40	4.50	4.60
D1	1.60	1.70	1.80
E	2.40	2.50	2.60
E1	4.05	-	4.25
e	1.50 Typ.		
e1	3.00 Typ.		
L	0.89	-	1.20