

FG2000FX-50DA

HIGH POWER INVERTER USE
PRESS PACK TYPE

FG2000FX-50DA



- ITQRM Repetitive controllable on-state current2200A
- IT(AV) Average on-state current 1050A
- VDRM Repetitive peak off state voltage2500V
- Anode short type

OUTLINE DRAWING

Dimensions in mm

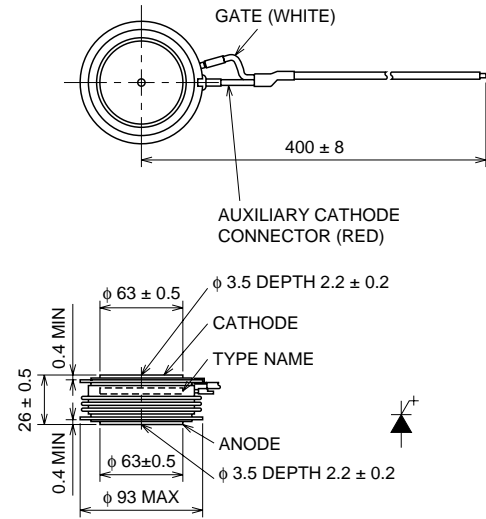

APPLICATION

Inverters, D.C. choppers, Induction heaters, D.C. to D.C. converters.

MAXIMUM RATINGS

Symbol	Parameter	Voltage class		Unit
		50DA		
VRRM	Repetitive peak reverse voltage	17		V
VRSM	Non-repetitive peak reverse voltage	17		V
VR(DC)	DC reverse voltage	17		V
VDRM	Repetitive peak off-state voltage*	2500		V
VD SM	Non-repetitive peak off-state voltage*	2500		V
VD(DC)	DC off-state voltage*	2000		V

* : VGK = -2V

Symbol	Parameter	Conditions	Ratings	Unit
ITQRM	Repetitive controllable on-state current	V _{DM} = 1875V, T _J = 125°C, C _S = 4.0μF, L _S = 0.3μH	2200	A
IT(RMS)	RMS on-state current		1650	A
IT(AV)	Average on-state current	f = 60Hz, sine wave θ = 180°, T _r = 73°C	1050	A
ITSM	Surge (non-repetitive) on-state current	One half cycle at 60Hz	16	kA
I ² t	Current-squared, time integration	One cycle at 60Hz	10.5 × 10 ⁵	A ² s
diT/dt	Critical rate of rise of on-state current	V _D = 1250V, I _{GM} = 30A, T _J = 125°C	1000	A/μs
VFGM	Peak forward gate voltage		10	V
VRGM	Peak reverse gate voltage		17	V
IFGM	Peak forward gate current		100	A
IRGM	Peak gate reverse current		650	A
PFGM	Peak forward gate power dissipation		280	W
PRGM	Peak reverse gate power dissipation		18	kW
PFG(AV)	Average forward gate power dissipation		50	W
PRG(AV)	Average reverse gate power dissipation		150	W
T _J	Junction temperature		-40 ~ +125	°C
T _{stg}	Storage temperature		-40 ~ +150	°C
—	Mounting force required	Recommended value 20	18 ~ 24	kN
—	Weight	Standard value	760	g

FG2000FX-50DA

HIGH POWER INVERTER USE
PRESS PACK TYPE

ELECTRICAL CHARACTERISTICS

Symbol	Parameter	Test conditions	Limits			Unit
			Min	Typ	Max	
V _{TM}	On-state voltage	T _j = 125°C, I _{TM} = 2000A, Instantaneous measurement	—	—	2.4	V
I _{RRM}	Repetitive peak reverse current	T _j = 125°C, V _{RRM} Applied	—	—	50	mA
I _{DRM}	Repetitive peak off-state current	T _j = 125°C, V _{DRM} Applied, V _{GK} = -2V	—	—	50	mA
I _{RG}	Reverse gate current	T _j = 125°C, V _{RG} = 17V	—	—	50	mA
dv/dt	Critical rate of rise of off-state voltage	T _j = 125°C, V _D = 1250V, V _{GK} = -2V	1000	—	—	V/μs
t _{gt}	Turn-on time	T _j = 125°C, I _{TM} = 2200A, I _{GM} = 30A, V _D = 1250V	—	—	10	μs
t _{gq}	Turn-off time	T _j = 125°C, I _{TM} = 2200A, V _{DM} = 1875V, di _{GQ} /dt = -30A/μs V _{RG} = 17V, C _s = 4.0μF, L _s = 0.3μH	—	—	30	μs
I _{GQM}	Peak gate turn-off current		—	610	—	A
V _{GT}	Gate trigger voltage	DC METHOD : V _D = 24V, R _L = 0.1Ω, T _j = 25°C	—	—	1.5	V
I _{GT}	Gate trigger current		—	—	2500	mA
R _{th(j-f)}	Thermal resistance	Junction to fin	—	—	0.017	°C/W

PERFORMANCE CURVES

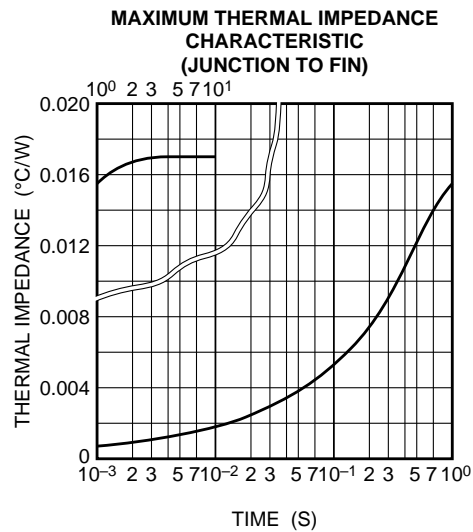
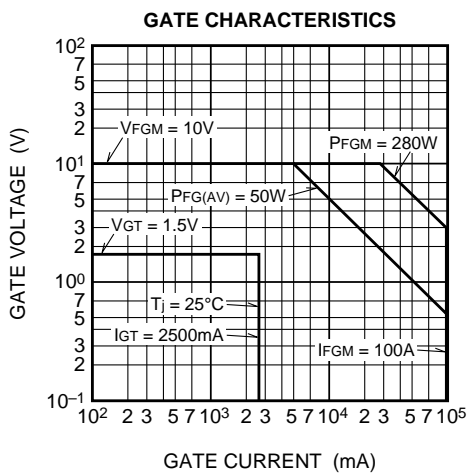
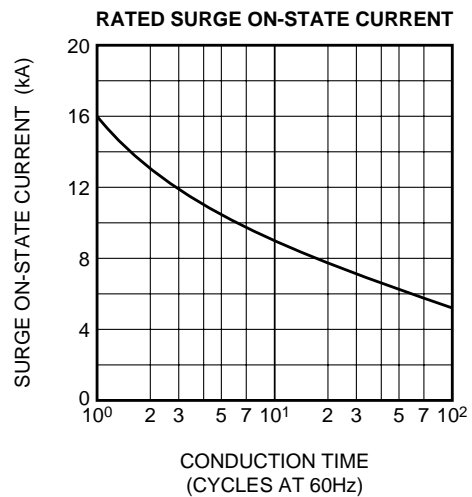
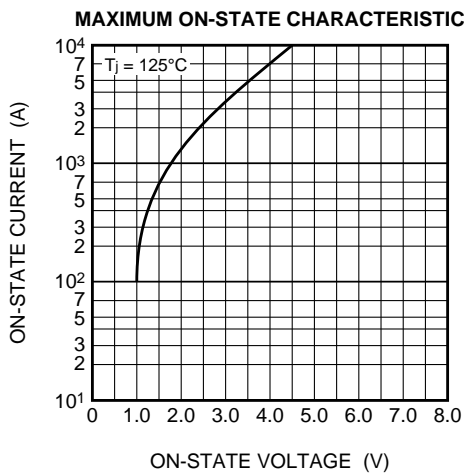

FG2000FX-50DA

HIGH POWER INVERTER USE
PRESS PACK TYPE

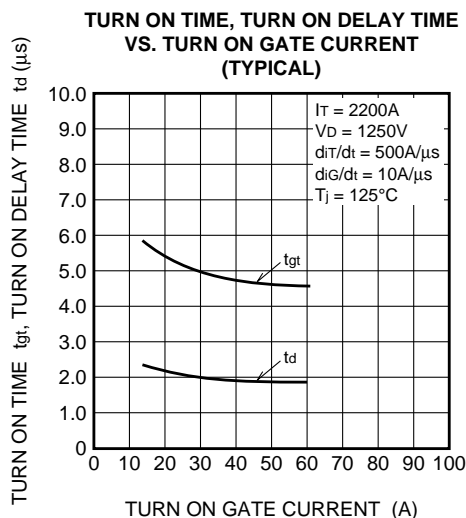
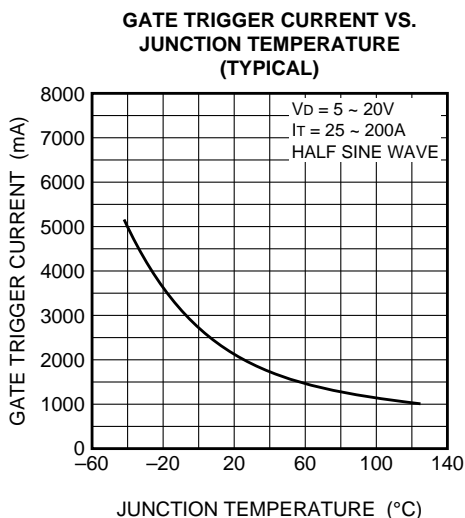
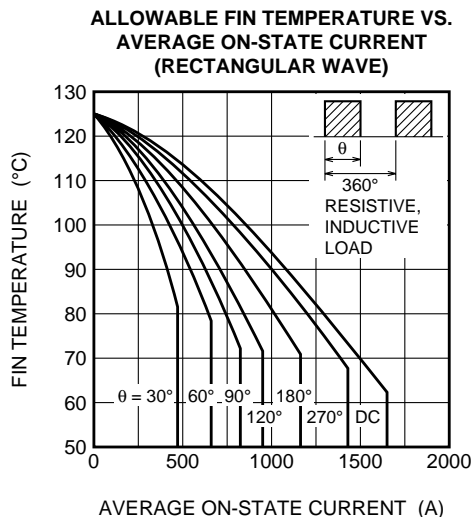
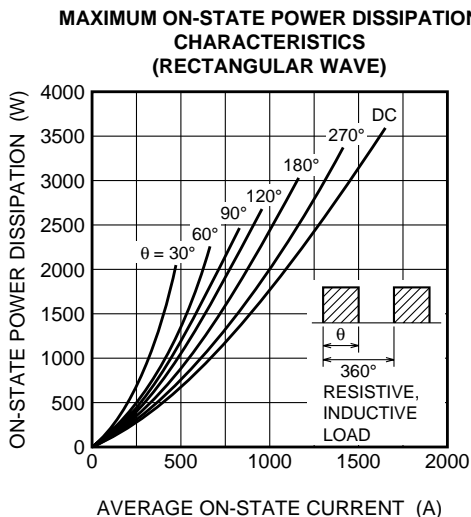
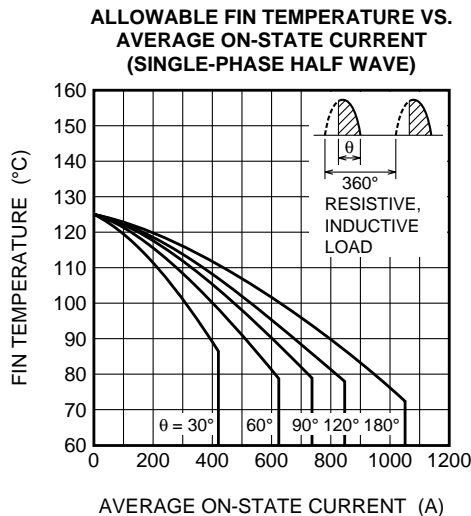
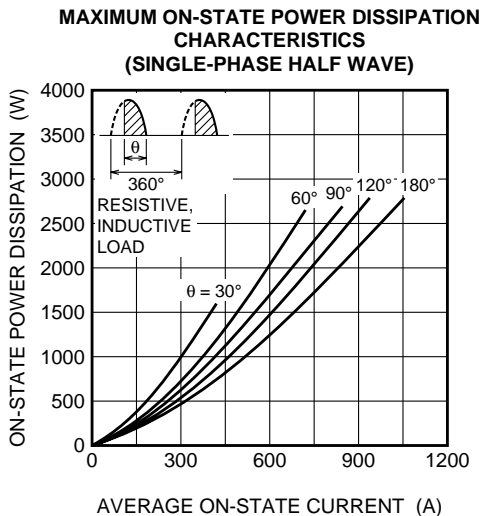

FG2000FX-50DA

HIGH POWER INVERTER USE
PRESS PACK TYPE

