

CGHV1F006S

6 W, DC - 15 GHz, 40V, GaN HEMT

Cree's CGHV1F006S is an unmatched, gallium nitride (GaN) high electron mobility transistor (HEMT) designed specifically for high efficiency, high gain and wide bandwidth capabilities. The device can be deployed for L, S, C, X and Ku-Band amplifier applications. The datasheet specifications are based on a C-Band (5.5 - 6.5 GHz) amplifier. Additional application circuits are available for C-Band at 5.8 GHz - 7.2 GHz and X-Band at 7.9 - 8.4 GHz and 8.5 - 9.6 GHz. The CGHV1F006S operates on a 40 volt rail circuit while housed in a 3mm x 4mm, surface mount, dual-flat-no-lead (DFN) package. Under reduced power, the transistor can operate below 40V to as low as 20V V_{DD} , maintaining high gain and efficiency.

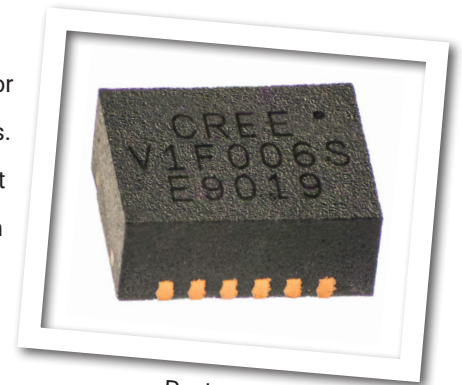

Package Type: 3x4 DFN
PN: CGHV1F006S

Typical Performance 5.5-6.5 GHz ($T_c = 25^\circ\text{C}$), 40 V

Parameter	5.5 GHz	6.0 GHz	6.5 GHz	Units
Small Signal Gain	15.4	16.5	17.8	dB
Output Power @ $P_{IN} = 28$ dBm	38.6	39.3	39.0	dBm
Drain Efficiency @ $P_{IN} = 28$ dBm	55	57	52	%

Note:
Measured in the CGHV1F006S-AMP application circuit. Pulsed 100 μs 10% duty.

Features for 40 V in CGHV1F006S-AMP

- Up to 15 GHz Operation
- 8 W Typical Output Power
- 17 dB Gain at 6.0 GHz
- 15 dB Gain at 9.0 GHz
- Application circuits for 5.8 - 7.2 GHz, 7.9 - 8.4 GHz, and 8.5 - 9.6 GHz.
- High degree of APD and DPD correction can be applied

Large Signal Models Available for ADS and MWO

Listing of Available Hardware Application Circuits / Demonstration Circuits

Application Circuit	Operating Frequency	Amplifier Class	Operating Voltage
CGHV1F006S-AMP1	5.85 - 7.2 GHz	Class A/B	40 V
CGHV1F006S-AMP2	7.9 - 8.4 GHz	Class A/B	40 V
CGHV1F006S-AMP3	8.5 - 9.6 GHz	Class A/B	40 V
CGHV1F006S-AMP4	4.9 - 5.9 GHz	Class A/B	20 V

Absolute Maximum Ratings (not simultaneous) at 25°C Case Temperature

Parameter	Symbol	Rating	Units	Notes
Drain-Source Voltage	V_{DSS}	120	Volts	25°C
Gate-to-Source Voltage	V_{GS}	-10, +2	Volts	25°C
Storage Temperature	T_{STG}	-65, +150	°C	
Operating Junction Temperature	T_J	225	°C	
Maximum Forward Gate Current	I_{GMAX}	1.2	mA	25°C
Maximum Drain Current ¹	I_{DMAX}	0.95	A	25°C
Soldering Temperature ²	T_S	245	°C	
Case Operating Temperature ^{3,4}	T_C	-40, +150	°C	
Thermal Resistance, Junction to Case ⁵	$R_{\theta JC}$	14.5	°C/W	85°C

Note:

¹ Current limit for long term, reliable operation

² Refer to the Application Note on soldering at www.cree.com/rf/document-library

³ Simulated at $P_{DISS} = 2.4$ W

⁴ T_C = Case temperature for the device. It refers to the temperature at the ground tab underneath the package. The PCB will add additional thermal resistance.

⁵ The $R_{\theta TH}$ for Cree's application circuit, CGHV1F006S-AMP, with 31 (Ø11 mil) via holes designed on a 20 mil thick Rogers 5880 PCB, is 3.9°C/W. The total $R_{\theta TH}$ from the heat sink to the junction is 14.5°C/W + 3.9°C/W = 18.4°C/W.

Electrical Characteristics ($T_C = 25^\circ\text{C}$) - 40 V Typical

Characteristics	Symbol	Min.	Typ.	Max.	Units	Conditions
DC Characteristics¹						
Gate Threshold Voltage	$V_{GS(th)}$	-3.6	-3.0	-2.4	V_{DC}	$V_{DS} = 10$ V, $I_D = 1.2$ mA
Gate Quiescent Voltage	$V_{GS(Q)}$	-	-2.7	-	V_{DC}	$V_{DS} = 40$ V, $I_D = 60$ mA
Saturated Drain Current ²	I_{DS}	0.86	1.2	-	A	$V_{DS} = 6.0$ V, $V_{GS} = 2.0$ V
Drain-Source Breakdown Voltage	$V_{(BR)DSS}$	100	-	-	V_{DC}	$V_{GS} = -8$ V, $I_D = 1.2$ mA
RF Characteristics³ ($T_C = 25^\circ\text{C}$, $F_0 = 5.925$ GHz unless otherwise noted)						
Small Signal Gain ^{3,4}	G	15.15	17.4	-	dB	$V_{DD} = 40$ V, $I_{DQ} = 60$ mA, $P_{IN} = 10$ dBm
Output Power ^{3,4}	P_{OUT}	37.5	38.7	-	dBm	$V_{DD} = 40$ V, $I_{DQ} = 60$ mA, $P_{IN} = 25.5$ dBm
Drain Efficiency ^{3,4}	η	35	52	-	%	$V_{DD} = 40$ V, $I_{DQ} = 60$ mA, $P_{IN} = 25.5$ dBm
Output Mismatch Stress ⁴	VSWR	-	10 : 1	-	Ψ	No damage at all phase angles, $V_{DD} = 40$ V, $I_{DQ} = 60$ mA, $P_{IN} = 25.5$ dBm
Dynamic Characteristics						
Input Capacitance ⁵	C_{GS}	-	1.3	-	pF	$V_{DS} = 40$ V, $V_{gs} = -8$ V, $f = 1$ MHz
Output Capacitance ⁵	C_{DS}	-	0.31	-	pF	$V_{DS} = 40$ V, $V_{gs} = -8$ V, $f = 1$ MHz
Feedback Capacitance	C_{GD}	-	0.04	-	pF	$V_{DS} = 40$ V, $V_{gs} = -8$ V, $f = 1$ MHz

Notes:

¹ Measured on wafer prior to packaging

² Scaled from PCM data

³ Measured in Cree's production test fixture. This fixture is designed for high volume testing at 5.925 GHz

⁴ Unmodulated Pulsed Signal 100 μ s, 10% duty cycle

⁵ Includes package

Electrical Characteristics When Tested in CGHV1F006S-AMP1 at C-Band Under OQPSK

Characteristics	Symbol	Min.	Typ.	Max.	Units	Conditions
RF Characteristics¹ ($T_c = 25^\circ\text{C}$, $F_o = 5.8 - 7.2\text{ GHz}$ unless otherwise noted)						
Gain	G	-	17.5	-	dB	$V_{DD} = 40\text{ V}$, $I_{DQ} = 60\text{ mA}$, $P_{IN} = 0\text{ dBm}$
Output Power ²	P_{OUT}	-	39	-	dBm	$V_{DD} = 40\text{ V}$, $I_{DQ} = 60\text{ mA}$, $P_{IN} = 27\text{ dBm}$
Drain Efficiency ²	η	-	55	-	%	$V_{DD} = 40\text{ V}$, $I_{DQ} = 60\text{ mA}$, $P_{IN} = 27\text{ dBm}$
OQPSK ³	ACL _R	-	-36	-	dBc	$V_{DD} = 40\text{ V}$, $I_{DQ} = 60\text{ mA}$, $P_{OUT} = 33\text{ dBm}$
Output Mismatch Stress ²	VSWR	-	10 : 1	-	Ψ	No damage at all phase angles, $V_{DS} = 40\text{ V}$, $I_{DQ} = 60\text{ mA}$

Notes:

¹ Measured in CGHV1F006S-AMP1 Application Circuit

² Pulsed 100 μs , 10% duty cycle

³ OQPSK modulated signal, 1.6 msp, PN23, Alpha Filter = 0.2 Offset = 1.6 MHz

Typical Performance - CGHV1F006S-AMP1 at C-Band Under OQPSK

Figure 1. - Typical Small Signal Response of CGHV1F006S-AMP1 Application Circuit
 $V_{DD} = 40\text{ V}$, $I_{DQ} = 60\text{ mA}$

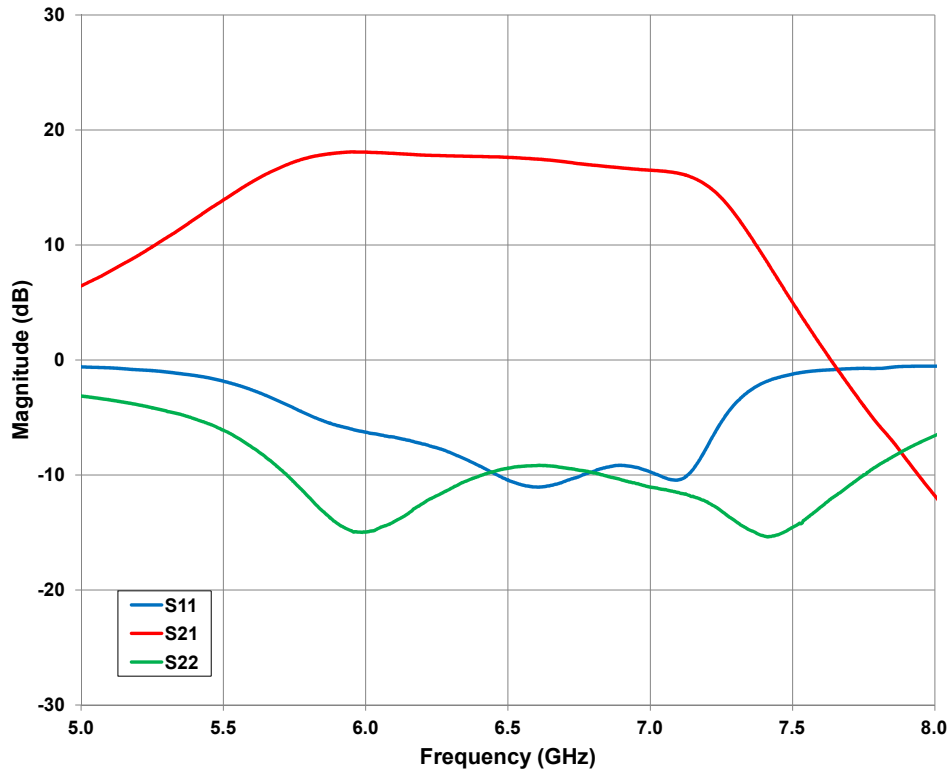

Typical Performance in Application Circuit CGHV1F006S-AMP1

Figure 2. - Typical Gain, Efficiency and OQPSK Performance vs Frequency

$P_{OUT} = 33 \text{ dBm}$, $V_{DD} = 40 \text{ V}$, $I_{DQ} = 60 \text{ mA}$

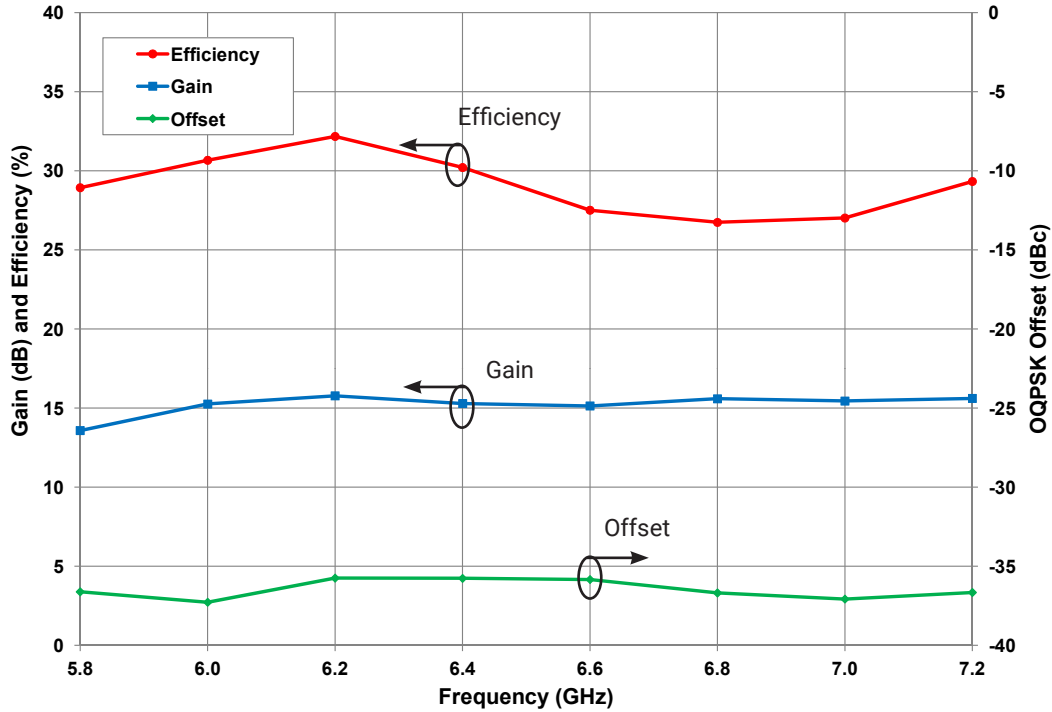
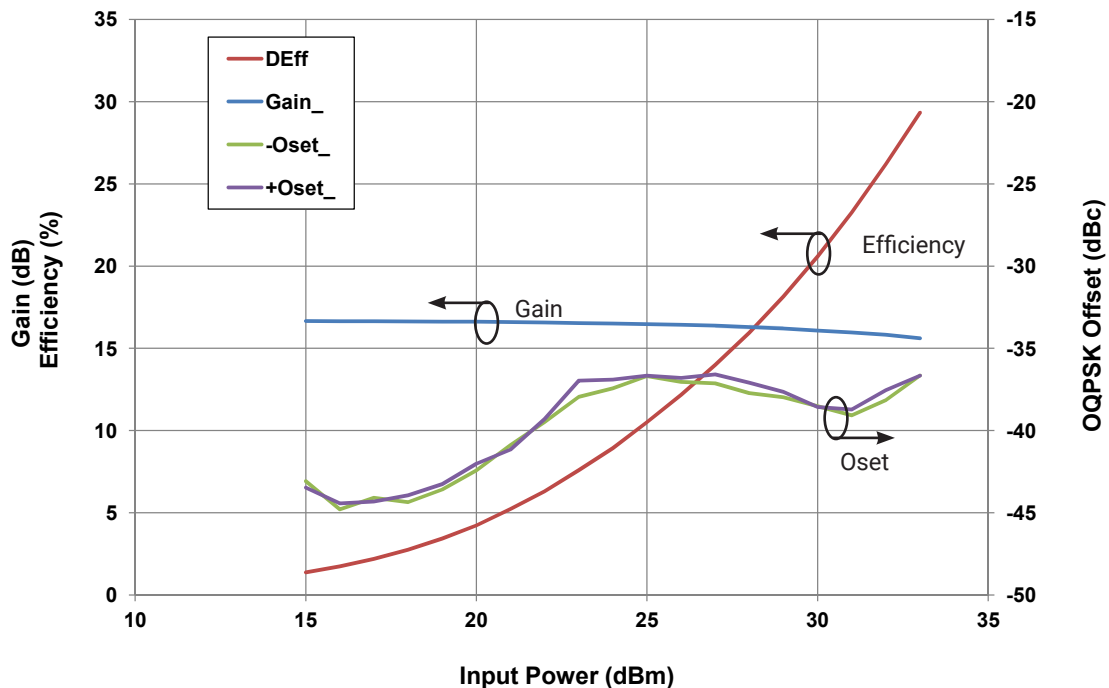

Figure 3. - Typical Gain, Efficiency and OQPSK Performance vs Input Power OQPSK Transfer

Frequency = 7.2 GHz, $V_{DD} = 40 \text{ V}$, $I_{DQ} = 60 \text{ mA}$



Typical Performance in Application Circuit CGHV1F006S-AMP1

Figure 4. - Typical Pulsed Power Response
 $V_{DD} = 40\text{ V}$, $I_{DQ} = 60\text{ mA}$, $100\ \mu\text{s}$, 10% Duty, $P_{IN} = 27\text{ dBm}$

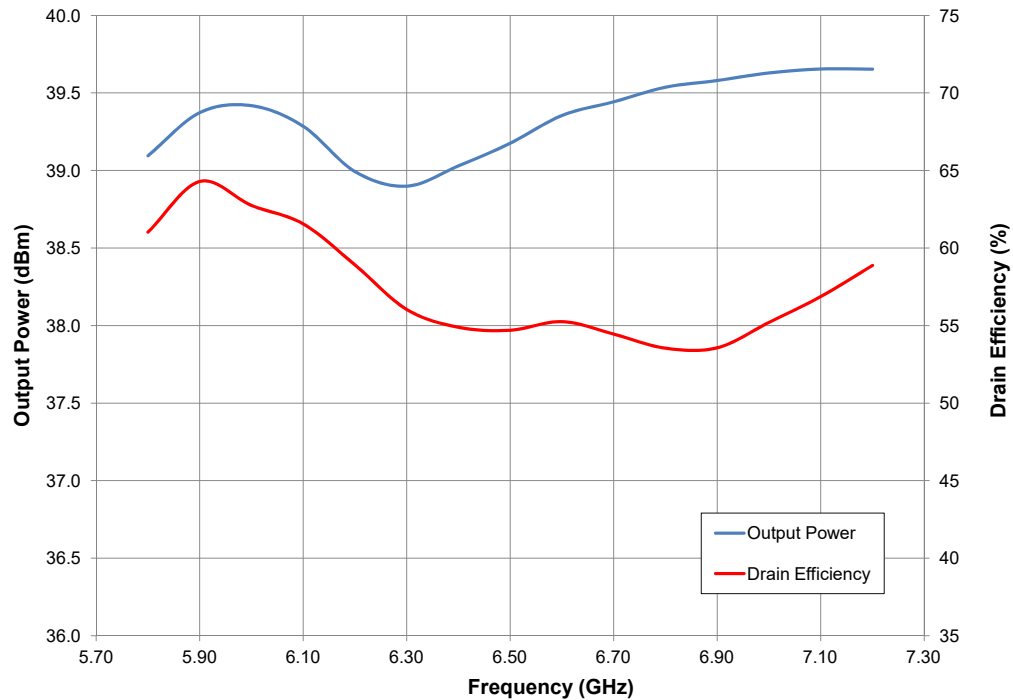

CGHV1F006S-AMP1 Application Circuit Bill of Materials, OQPSK

Designator	Description	Qty
R1	RES, 15, OHM, +1/-1%, 1/16 W, 0402	1
R2	RES, 100, OHM, +1/-1%, 1/16 W, 0603	1
C1, C14	CAP, 1.8 pF, ±0.1 pF, 0603, ATC	2
C2	CAP, 2.0 pF, ±0.1 pF, 0402, ATC	1
C3, C8	CAP, 1.5 pF, ±0.1 pF, 0402, ATC	2
C4	CAP, 10 pF, ±5%, 0603, ATC	1
C5, C10	CAP, 470 pF, 5%, 100 V, 0603, X	2
C6, C11	CAP, 33000 pF, 0805, 100V, X7R	2
C7	CAP, 10 uF, 16 V, TANTALUM	1
C9	CAP, 20 pF, ±5%, 0603, ATC	1
C12	CAP, 1.0 uF, 100V, 10% X7R, 1210	1
C13	CAP, 33 uF, 20%, G CASE	1
J1, J2	CONN, SMA, PANEL MOUNT JACK, FLANGE	2
J3	PCB, RT5880, 0.020" THK, CGHV1F006S	1
J3	HEADER RT>PLZ .1CEN LK 5POS	1
Q1	QFN TRANSISTOR CGHV1F006S	1

CGHV1F006S-AMP1 Application Circuit

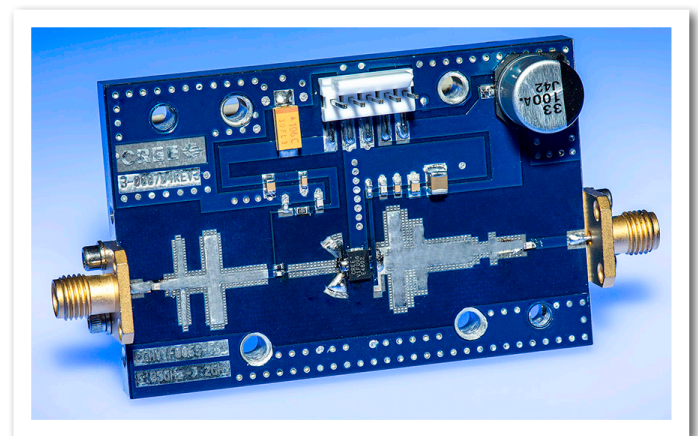

CGHV1F006S-AMP1 Application Circuit Schematic, OQPSK

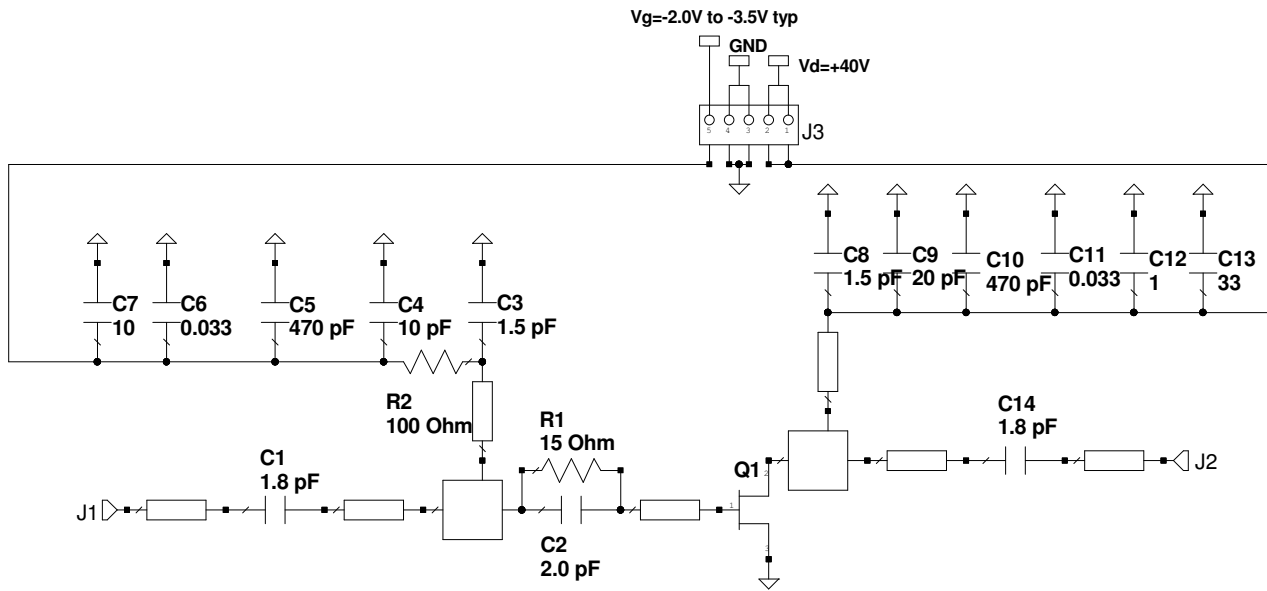

CGHV1F006S-AMP1 Application Circuit Outline, OQPSK

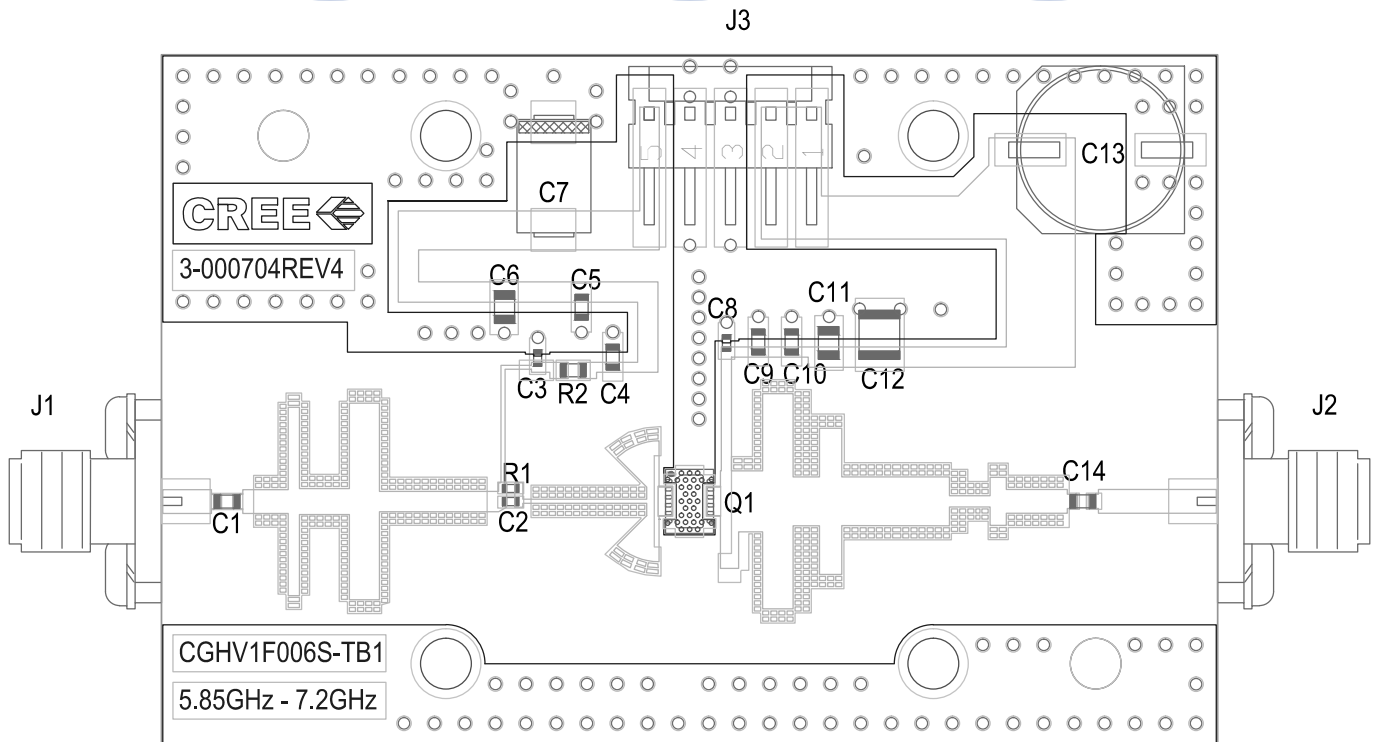

Electrical Characteristics When Tested in CGHV1F006S-AMP2 at X-Band, SATCOM

Characteristics	Symbol	Min.	Typ.	Max.	Units	Conditions
RF Characteristics¹ ($T_c = 25^\circ\text{C}$, $F_o = 7.9 - 8.4\text{ GHz}$ unless otherwise noted)						
Gain	G	-	15	-	dB	$V_{DD} = 40\text{ V}$, $I_{DQ} = 60\text{ mA}$, $P_{IN} = 0\text{ dBm}$
Output Power ²	P_{OUT}	-	39	-	dBm	$V_{DD} = 40\text{ V}$, $I_{DQ} = 60\text{ mA}$, $P_{IN} = 28\text{ dBm}$
Drain Efficiency ²	η	-	55	-	%	$V_{DD} = 40\text{ V}$, $I_{DQ} = 60\text{ mA}$, $P_{IN} = 28\text{ dBm}$
OQPSK ³	ACLR	-	-37	-	dBc	$V_{DD} = 40\text{ V}$, $I_{DQ} = 60\text{ mA}$, $P_{OUT} = 33\text{ dBm}$
Output Mismatch Stress ²	VSWR	-	10 : 1	-	Y	No damage at all phase angles, $V_{DD} = 40\text{ V}$, $I_{DQ} = 60\text{ mA}$, $P_{IN} = 28\text{ dBm}$

Notes:

¹ Measured in CGHV1F006S-AMP2 Application Circuit

² Pulsed 100 μs , 10% duty cycle

³ OQPSK modulated signal, 1.6 msp, PN23, Alpha Filter = 0.2 Offset = 1.6 MHz

Typical Performance in Application Circuit CGHV1F006S-AMP2 at X-Band, SATCOM

Figure 5. - Typical Small Signal Response of CGHV1F006S-AMP2 Application Circuit
 $V_{DD} = 40\text{ V}$, $I_{DQ} = 60\text{ mA}$

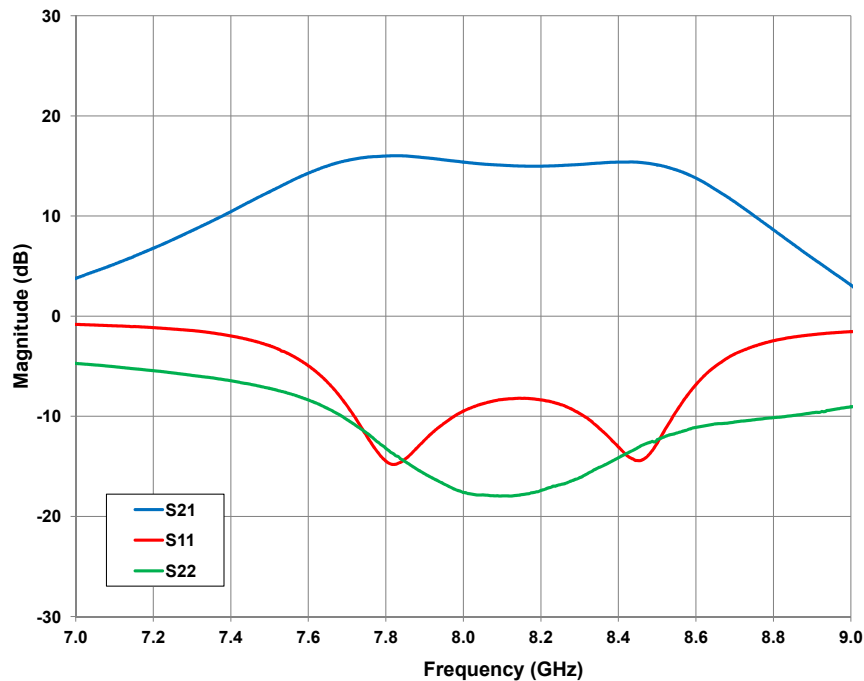

Typical Performance in Application Circuit CGHV1F006S-AMP2

Figure 6. - Typical OQPSK Response
 $V_{DD} = 40\text{ V}$, $I_{DQ} = 60\text{ mA}$, 1.6 MSPS , $P_{OUT} = 33\text{ dBm}$

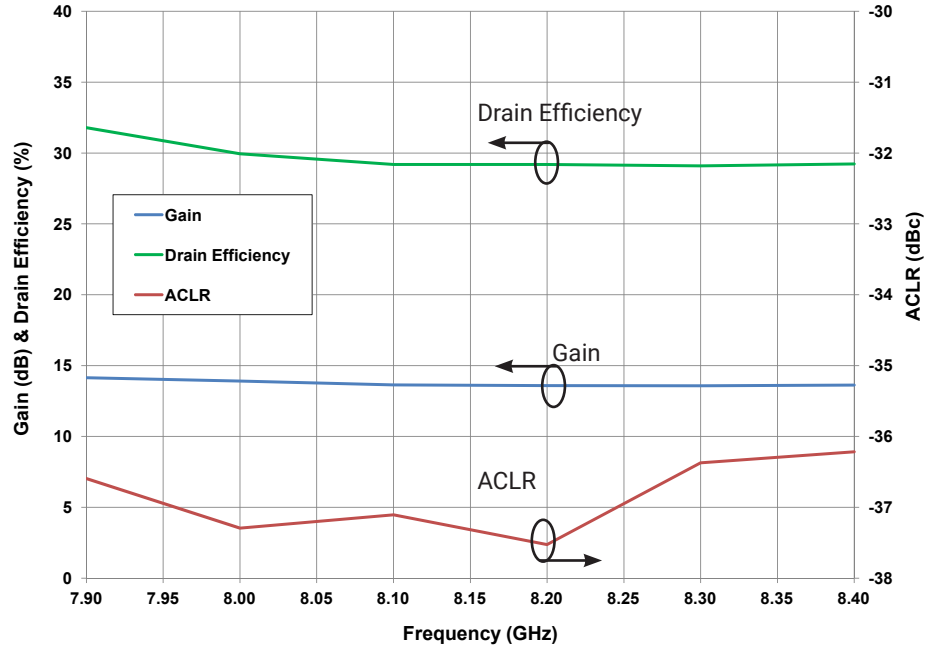

Typical Performance in Application Circuit CGHV1F006S-AMP2

Figure 7. - OQPSK Transfer Response
 $V_{DD} = 40\text{ V}$, $I_{DQ} = 60\text{ mA}$, 1.6 MSPS , Frequency = 8.4 GHz

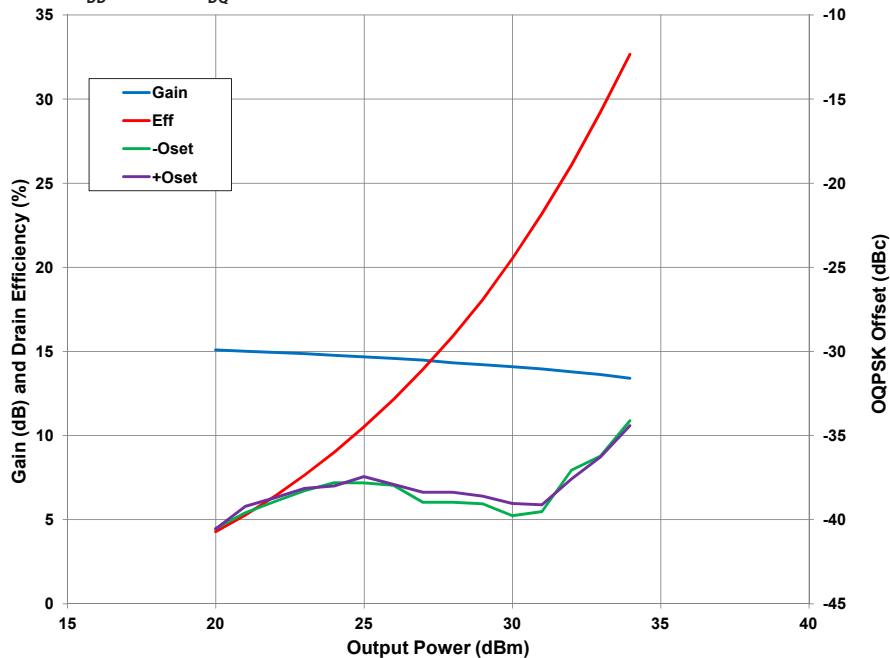

Typical Performance in Application Circuit CGHV1F006S-AMP2

Figure 8. - Typical Pulsed Power Response
 $V_{DD} = 40\text{ V}$, $I_{DQ} = 60\text{ mA}$, $100\ \mu\text{s}$, 10% Duty, $P_{IN} = 28\text{ dBm}$

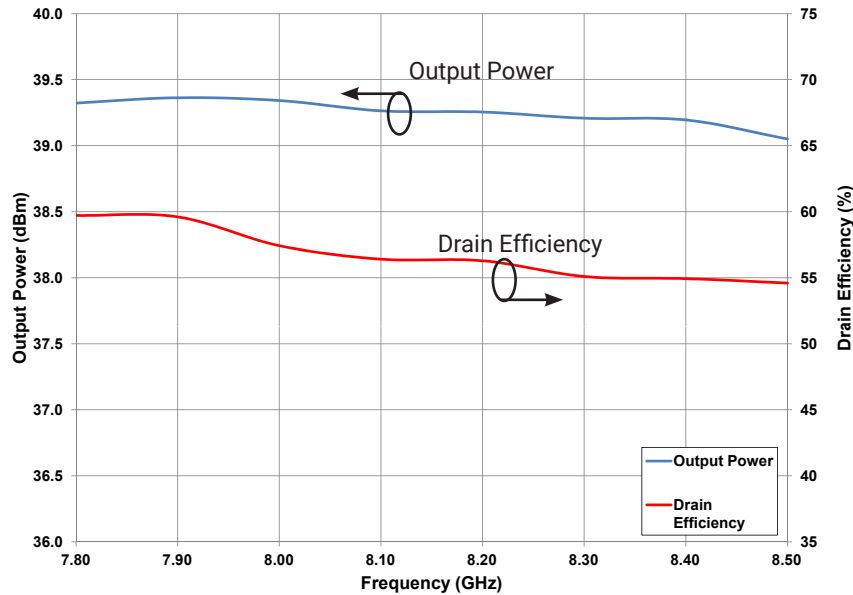

CGHV1F006S-AMP2 Application Circuit Bill of Materials, SATCOM

Designator	Description	Qty
R1	RES, 15, OHM, +1/-1%, 1/16 W, 0402	1
R2	RES, 100, OHM, +1/-1%, 1/16 W, 0603	1
C3, C8	CAP, 1.0pF, ±0.05 pF, 0402, ATC	2
C14	CAP, 1.0pF, ±5%, 0603, ATC	1
C1	CAP, 1.2pF, ±5%, 0603, ATC	1
C2	CAP, 1.6pF, ±5%, 0402, ATC	1
C4	CAP, 10pF, ±5%, 0603, ATC	1
C5, C10	CAP, 470pF, 5%, 100V, 0603, X	2
C6, C11	CAP, 33000pF, 0805, 100V, X7R	2
C7	CAP, 10 UF, 16 V, TANTALUM	1
C9	CAP, 20 pF, ±5%, 0603, ATC	1
C12	CAP, 1.0 UF, 100V, 10% X7R, 1210	1
C13	CAP, 33 UF, 20%, G CASE	1
J1, J2	CONN, SMA, PANEL MOUNT JACK, FLANGE	2
	PCB, RT5880, 0.020" THK, CGHV1F006S	1
	BASEPLATE, AL, 2.60 X 1.70 X 2.50	1
J3	HEADER RT>PLZ .1CEN LK 5POS	1
	2-56 SOC HD SCREW 1/4 SS	4
	#2 SPLIT LOCKWASHER SS	4
Q1	QFN TRANSISTOR CGHV1F006S	1

CGHV1F006S-AMP2 Application Circuit

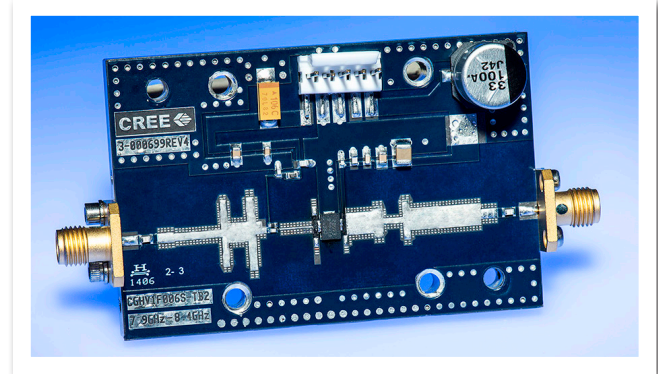

CGHV1F006S-AMP2 Application Circuit Schematic, SATCOM

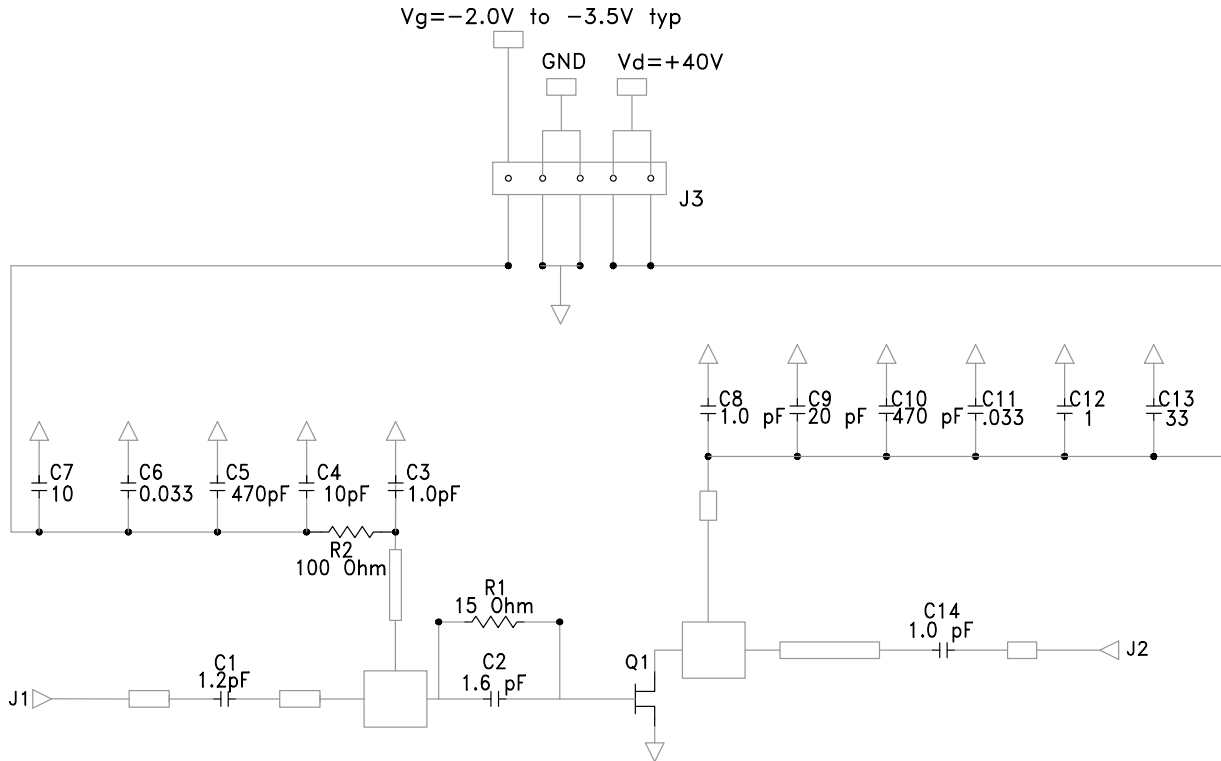

CGHV1F006S-AMP2 Application Circuit Outline, SATCOM

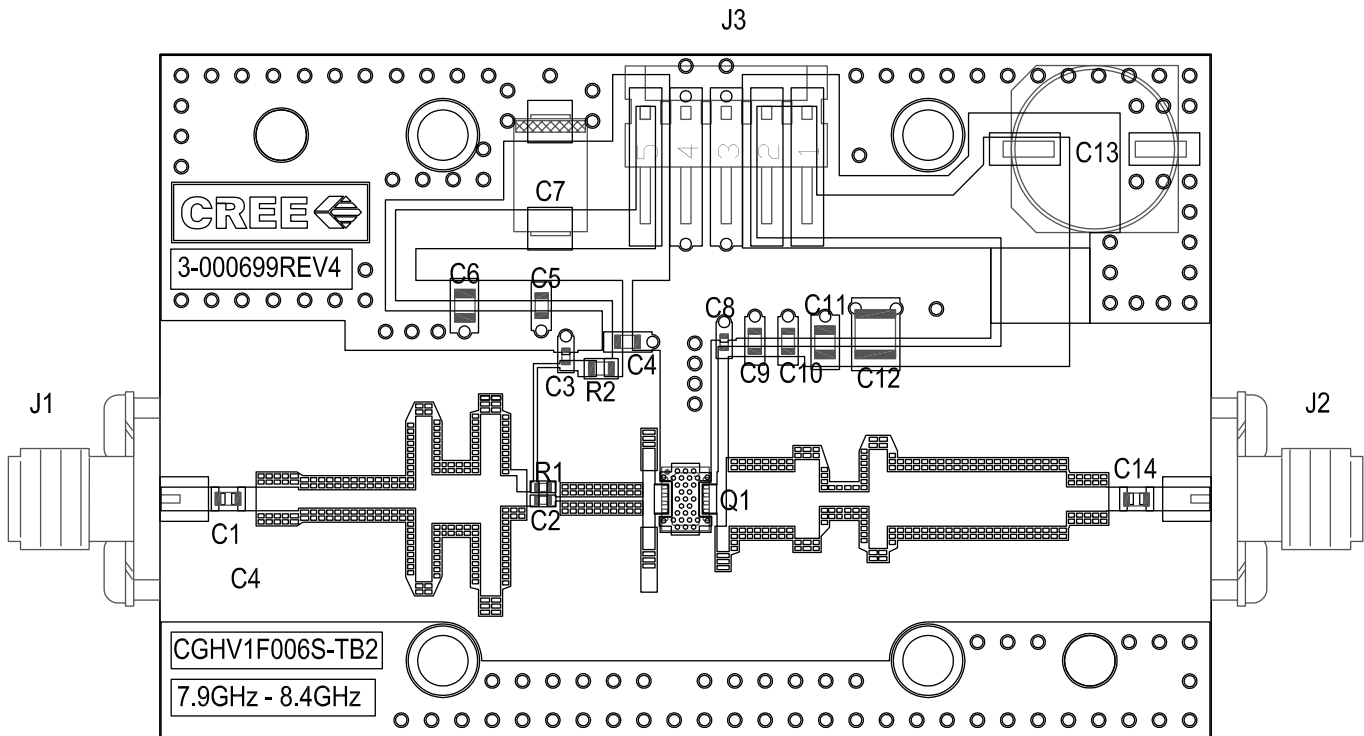

Electrical Characteristics When Tested in CGHV1F006S-AMP3 at X-Band, RADAR

Characteristics	Symbol	Min.	Typ.	Max.	Units	Conditions
RF Characteristics¹ ($T_c = 25^\circ\text{C}$, $F_0 = 8.5 - 9.6\text{ GHz}$ unless otherwise noted)						
Gain	G	-	14.5	-	dB	$V_{DD} = 40\text{ V}$, $I_{DQ} = 60\text{ mA}$, $P_{IN} = 0\text{ dBm}$
Output Power ²	P_{OUT}	-	38.5	-	dBm	$V_{DD} = 40\text{ V}$, $I_{DQ} = 60\text{ mA}$, $P_{IN} = 28\text{ dBm}$
Drain Efficiency ²	η	-	52	-	%	$V_{DD} = 40\text{ V}$, $I_{DQ} = 60\text{ mA}$, $P_{IN} = 28\text{ dBm}$
Output Mismatch Stress ²	VSWR	-	10 : 1	-	Y	$V_{DD} = 40\text{ V}$, $I_{DQ} = 60\text{ mA}$, $P_{IN} = 28\text{ dBm}$

Notes:

¹ Measured in CGHV1F006S-AMP3 Application Circuit

² Pulsed 100 μs , 10% duty cycle

Typical Performance in Application Circuit CGHV1F006S-AMP3 at X-Band, RADAR

Figure 9. - Typical Small Signal Response
 $V_{DD} = 40\text{ V}$, $I_{DQ} = 60\text{ mA}$

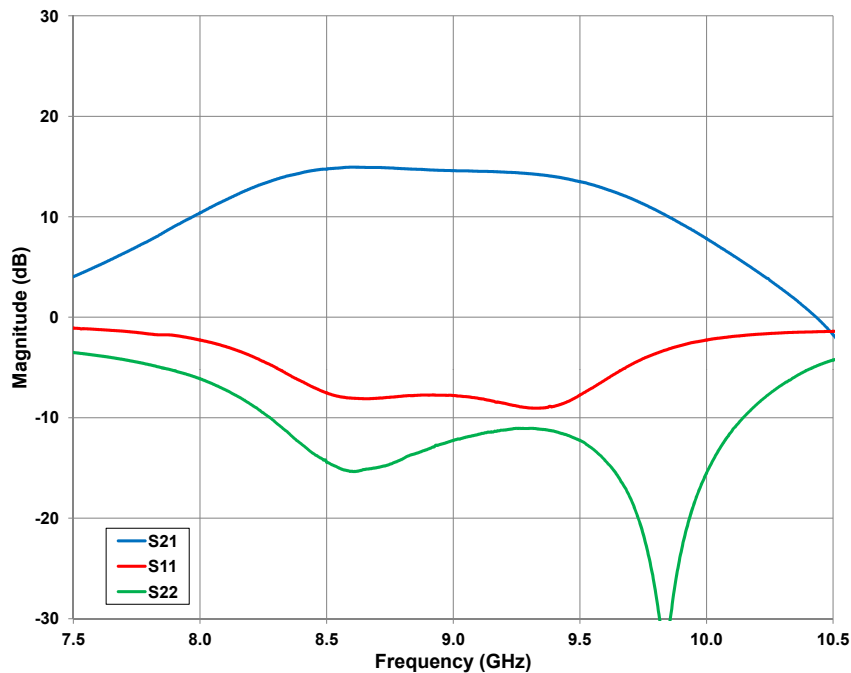

Typical Performance in Application Circuit CGHV1F006S-AMP3

Figure 10. - Typical Pulsed Power Response
 $V_{DD} = 40\text{ V}$, $I_{DQ} = 60\text{ mA}$, $100\ \mu\text{s}$, 10% Duty, $P_{IN} = 28\text{ dBm}$

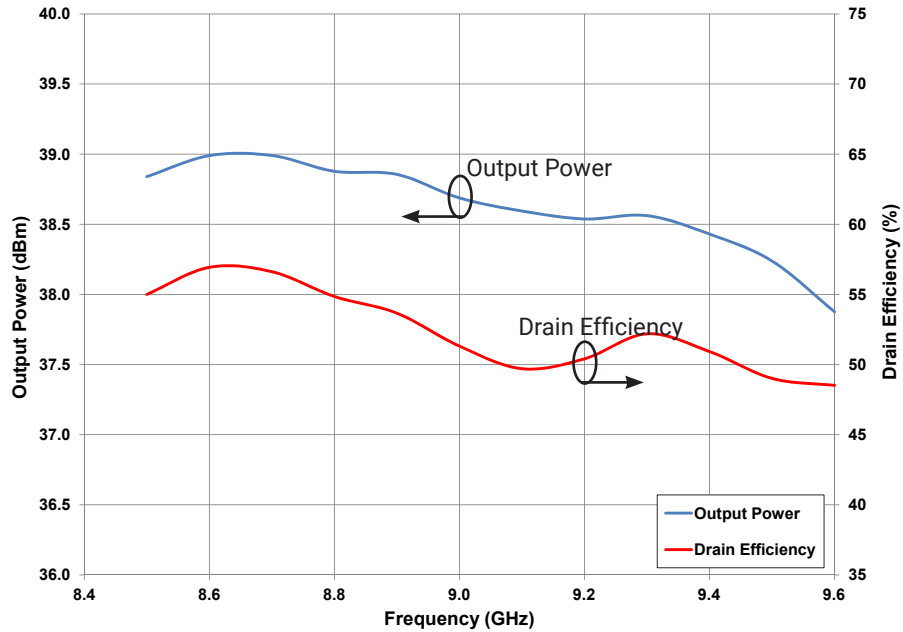

CGHV1F006S-AMP3 Application Circuit Bill of Materials, RADAR

Designator	Description	Qty
R1	RES, 15, OHM, +1/-1%, 1/16 W, 0402	1
R2	RES, 100, OHM, +1/-1%, 1/16 W, 0603	1
C1, C14	CAP, 1.0 pF, ±0.05 pF, 0603, ATC	2
C2	CAP, 1.0 pF, ±0.05 pF, 0402, ATC	1
C3, C8	CAP, 0.8 pF, ±0.05 pF, 0402, ATC	2
C4	CAP, 10 pF, ±5%, 0603, ATC	1
C5, C10	CAP, 470 pF, 5%, 100 V, 0603, X	2
C6, C11	CAP, 33000 pF, 0805, 100V, X7R	2
C7	CAP, 10 UF, 16 V, TANTALUM	1
C9	CAP, 20 pF, ±5%, 0603, ATC	1
C12	CAP, 1.0 UF, 100V, 10% X7R, 1210	1
C13	CAP, 33 UF, 20%, G CASE	1
J1, J2	CONN, SMA, PANEL MOUNT JACK, FLANGE	2
J3	HEADER RT>PLZ .1CEN LK 5POS	1
Q1	QFN TRANSISTOR CGHV1F006S	1

CGHV1F006S-AMP3 Application Circuit

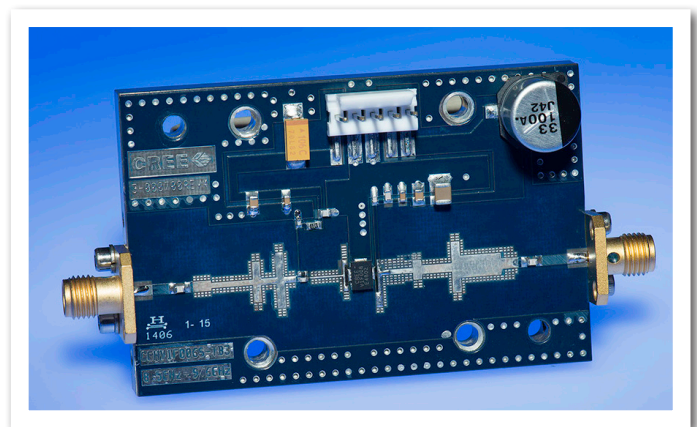

CGHV1F006S-AMP3 Application Circuit Schematic, RADAR

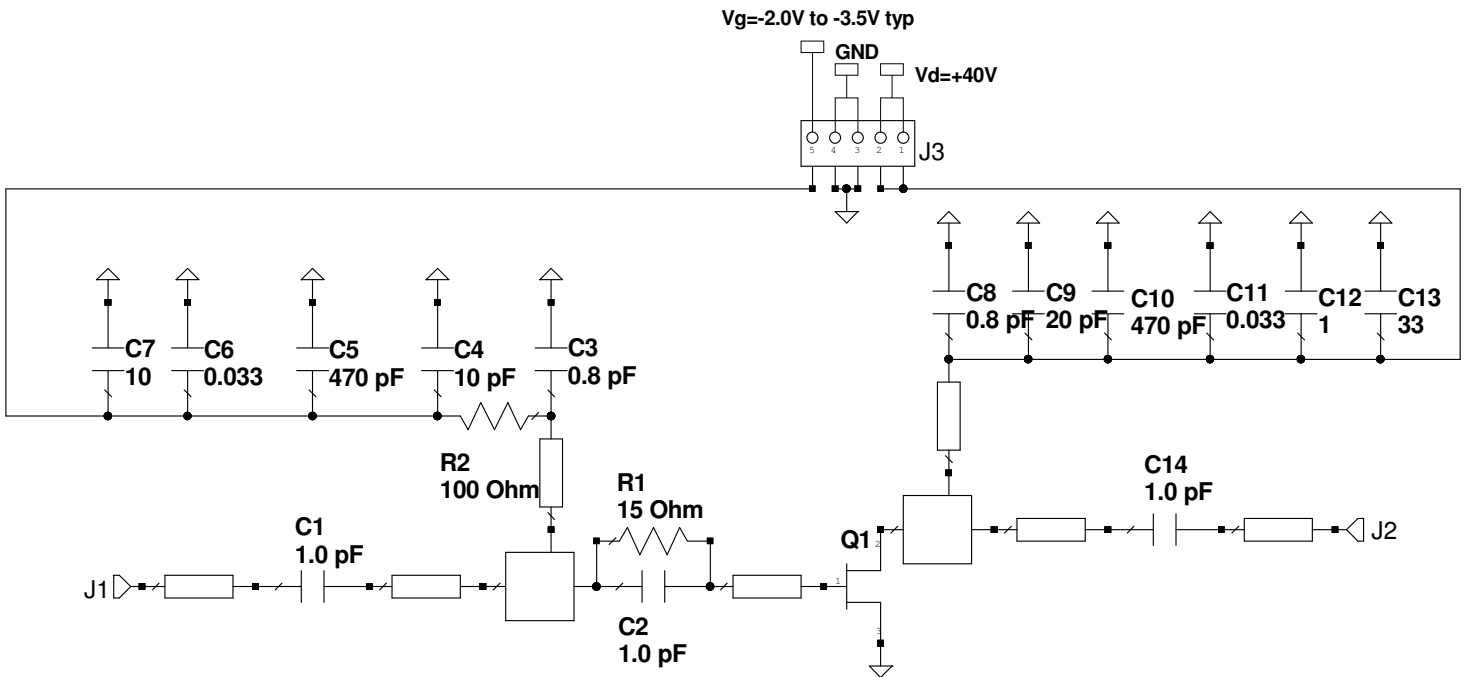

CGHV1F006S-AMP3 Application Circuit Outline, RADAR

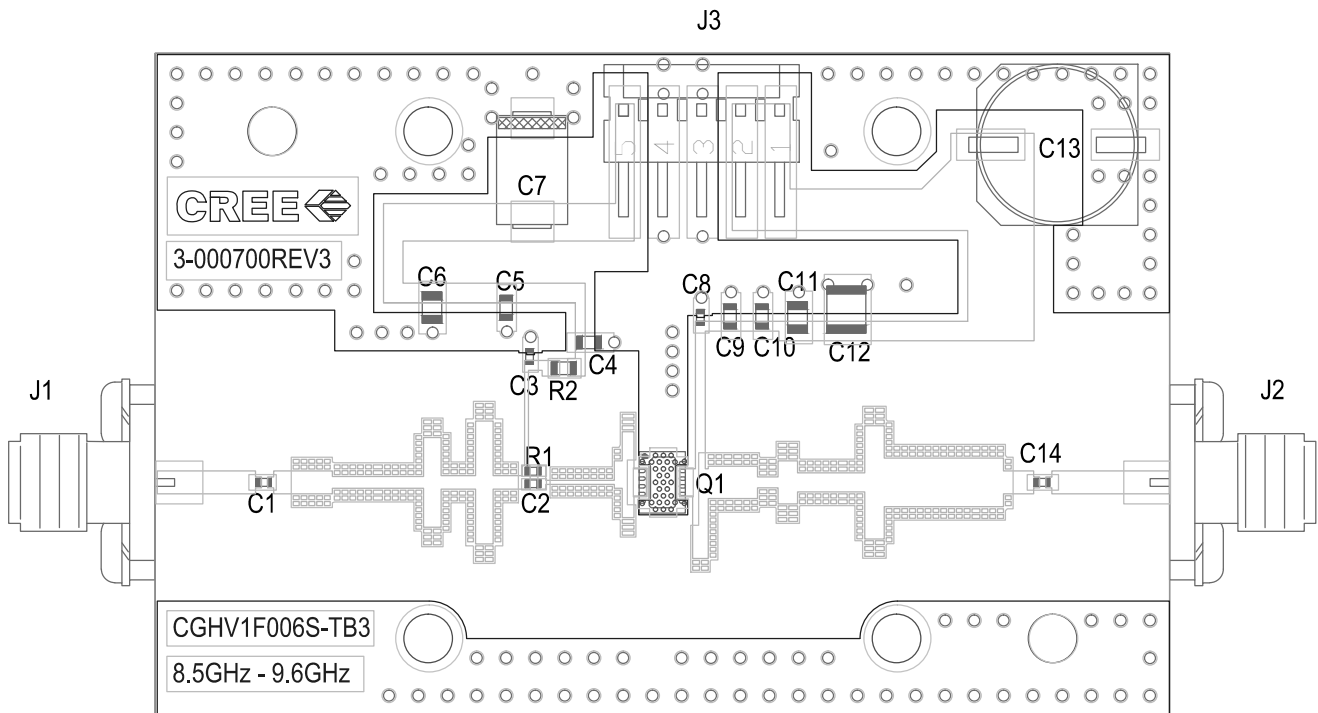

Electrical Characteristics When Tested in CGHV1F006S-AMP4 at 802.11

Characteristics	Symbol	Min.	Typ.	Max.	Units	Conditions
RF Characteristics¹ ($T_c = 25^\circ\text{C}$, $F_o = 4.9 - 5.9\text{ GHz}$ unless otherwise noted)						
Gain	G	-	13	-	dB	$V_{DD} = 20\text{ V}$, $I_{DQ} = 30\text{ mA}$, $P_{IN} = 27\text{ dBm}$
Drain Efficiency ²	η	-	27	-	%	$V_{DD} = 20\text{ V}$, $I_{DQ} = 30\text{ mA}$, $P_{IN} = 27\text{ dBm}$
OQPSK ³	ACLR	-	-43	-	dBc	$V_{DD} = 20\text{ V}$, $I_{DQ} = 30\text{ mA}$, $P_{OUT} = 27\text{ dBm}$
Output Mismatch Stress ²	VSWR	-	10 : 1	-	Y	No damage at all phase angles, $V_{DD} = 20\text{ V}$, $I_{DQ} = 30\text{ mA}$, $P_{IN} = 27\text{ dBm}$

Notes:

¹ Measured in CGHV1F006S-AMP4 Application Circuit

² Single carrier WCDMA, 3GPP Test Model 1, G4 DPCH, 45% clipping, PAR = 7.5 dB @ 0.01% probability on CCDF

Typical Performance - CGHV1F006S-AMP4 at 802.11

Figure 11. - Typical Small Signal Response

$V_{DD} = 20\text{ V}$, $I_{DQ} = 30\text{ mA}$

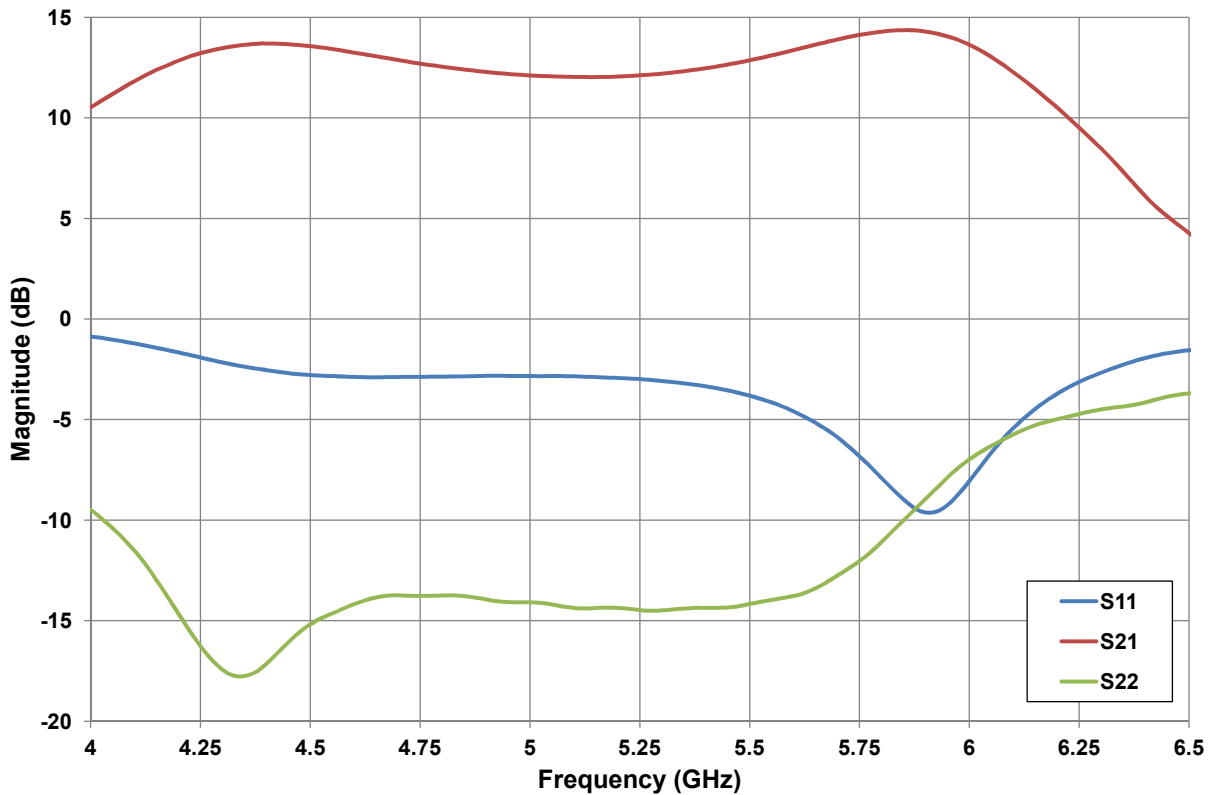

Typical Performance in Application Circuit CGHV1F006S-AMP4

Figure 12. - Typical Gain, Efficiency and WCDMA Performance vs Frequency
 $V_{DD} = 20\text{ V}$, $I_{DQ} = 30\text{ mA}$, $P_{OUT} = 27\text{ dBm}$

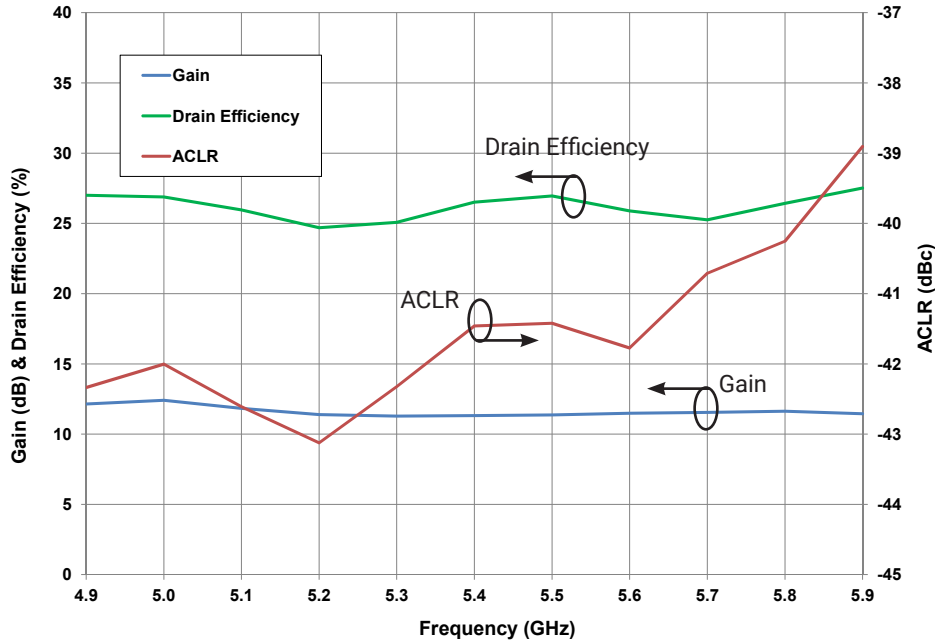

CGHV1F006S-AMP4 Application Circuit Bill of Materials at 802.11

Designator	Description	Qty
R1, R3	RES, 1, OHM, +/-1%, 1/16 W, 0402	2
R2	RES, 51.1, OHM, +/-1%, 1/16W, 0603	1
C2, C6, C11	CAP, 1.8 pF, +/-0.1 pF, 0603, ATC	3
C1	CAP, 0.2 pF, +/-0.05 pF, 0402, ATC	1
C3, C7, C12	CAP, 470 pF, 5%, 100 V, 0603, X	3
C4, C8, C13	CAP, 33000 pF, 0805, 100 V, X7R	3
C5	CAP, 10 UF, 16 V, TANTALUM	1
C15	CAP, 6.8 pF, ±0.25 pF, 100 V, 0603	1
C9, C14	CAP, 1.0 UF, 100V, 10% X7R, 1210	2
C10	CAP, 33 UF, 20%, G CASE	1
J1, J2	CONN, SMA, PANEL MOUNT JACK, FLANGE	2
	PCB, RT5880, 0.020" THK, CGHV1F006S	1
	BASEPLATE, CGH35015, 2.60 X 1.7	1
J3	HEADER RT>PLZ .1CEN LK 5POS	1
	2-56 SOC HD SCREW 1/4 SS	4
	#2 SPLIT LOCKWASHER SS	4
Q1	QFN TRANSISTOR CGHV1F006S	1

CGHV1F006S-AMP4 Application Circuit

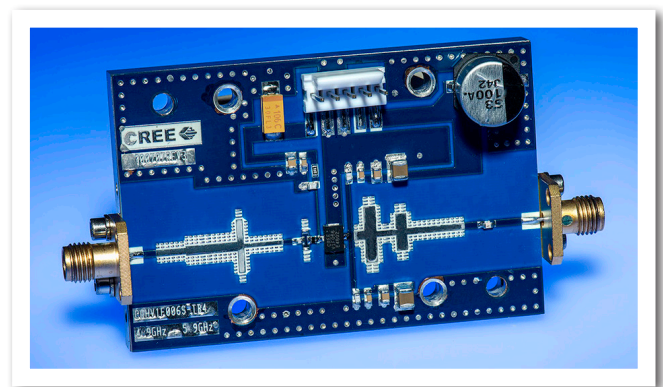

CGHV1F006S-AMP4 Application Circuit Schematic

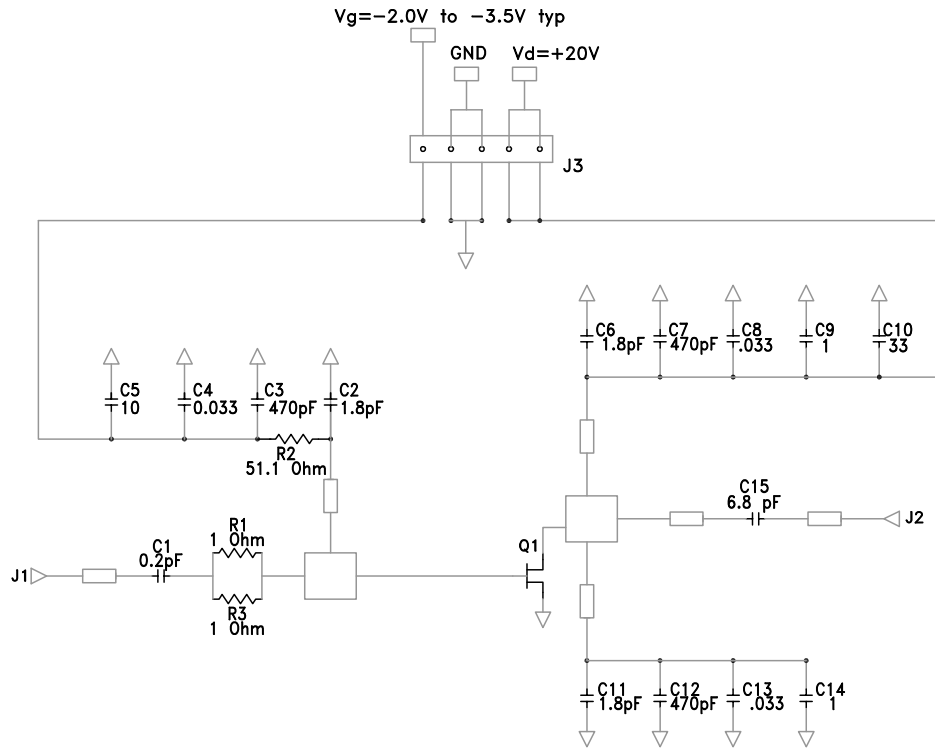

CGHV1F006S-AMP4 Application Circuit Outline

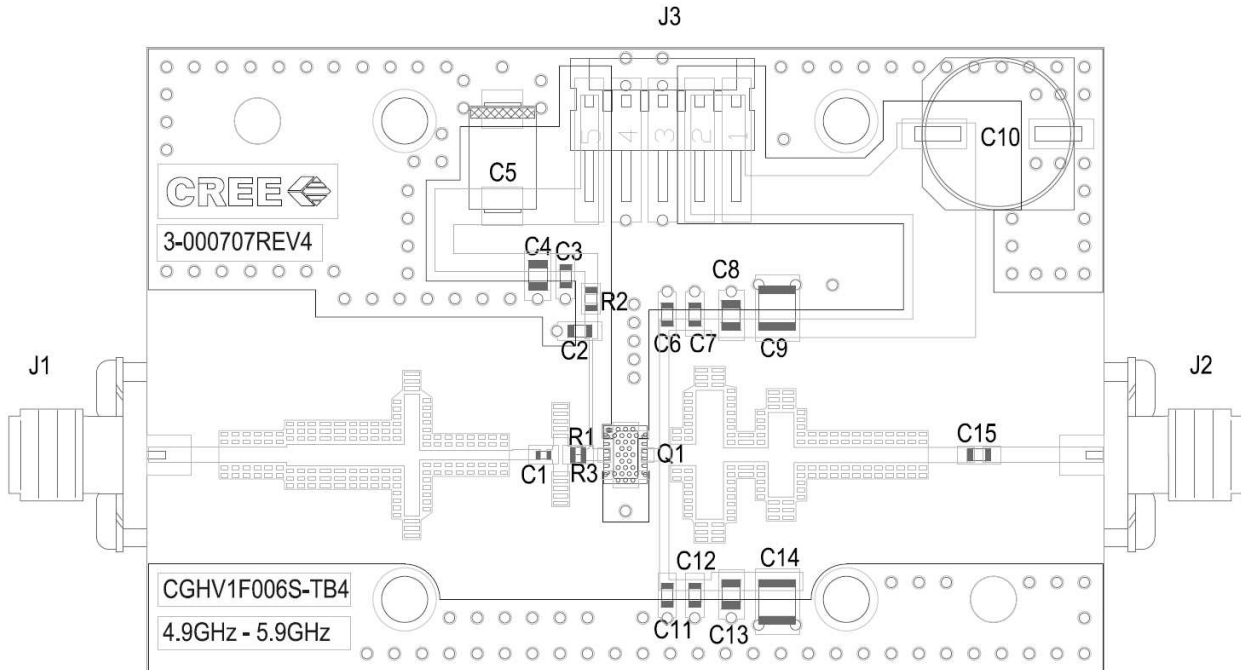

CGHV1F006S Power Dissipation De-rating Curve

Figure 13. - CGHV1F006S Transient Power Dissipation De-Rating Curve

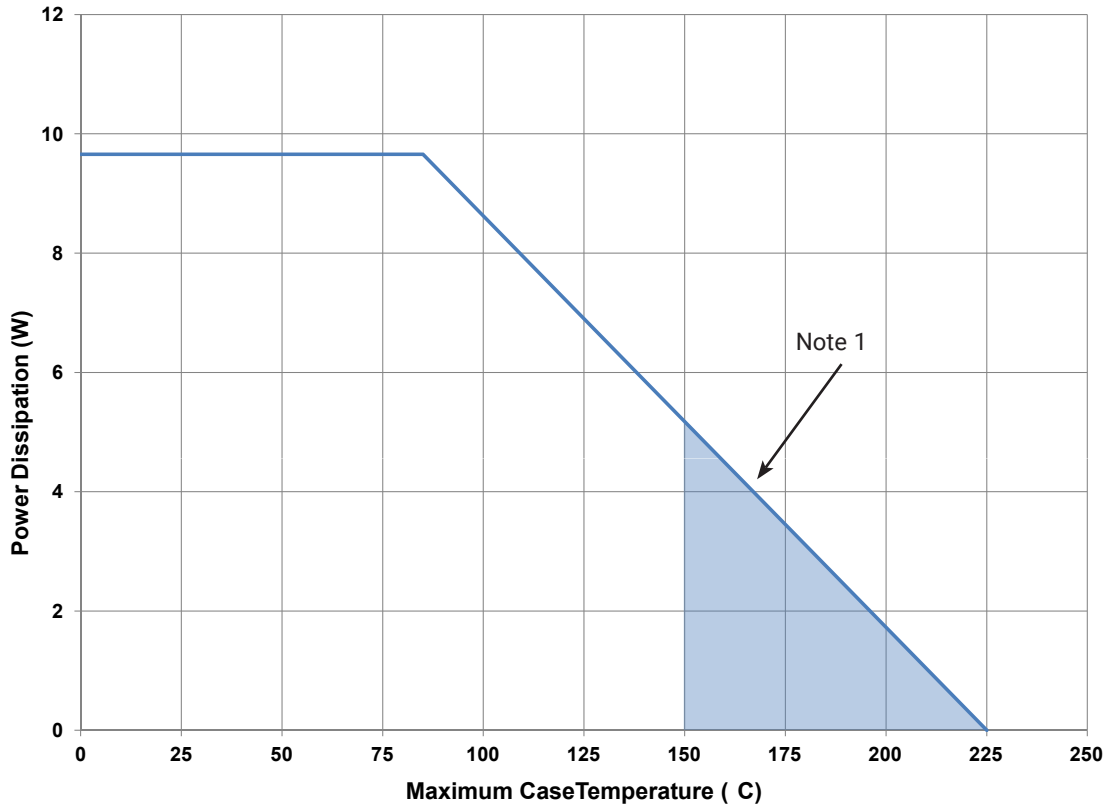

Note 1. Area exceeds Maximum Case Temperature (See Page 2).

Electrostatic Discharge (ESD) Classifications

Parameter	Symbol	Class	Test Methodology
Human Body Model	HBM	1B (≥ 500 V)	JEDEC JESD22 A114-D
Charge Device Model	CDM	II (≥ 200 V)	JEDEC JESD22 C101-C

Source and Load Impedances

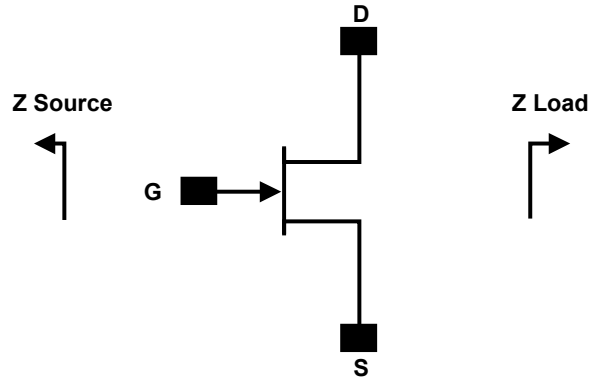

Frequency (GHz)	Z Source	Z Load
1	49.67 + j32.81	184.11 + j6.66
3	11.54 + j3.96	38.83 + j56.37
6	5.94 - j17.97	13.03 + j16.16
10	11.87 - j77.62	11.79 - j17.43
12	47.42 - j205.35	16.39 - j46.22
15	33.78 + j251.03	163.61 - j268.44

Note¹: $V_{DD} = 40\text{ V}$, $I_{DQ} = 60\text{ mA}$

Note²: Impedances are extracted from source and load pull data derived from the transistor.

Product Dimensions CGHV1F006S (Package 3 x 4 DFN)

SYMBOL	COMMON DIMENSIONS			NOTE
	MIN.	NOM.	MAX.	
A	0.80	0.85	0.90	
A1	0.00	0.02	0.05	
A3	0.203 REF.			
Ø	0		12	2
D	4.00 BSC			
E	3.00 BSC			
Ⓞ	0.50 BSC			
N	12			3
ND	6			▲
L	0.35	0.40	0.45	
b	0.18	0.25	0.30	▲
D2	3.20	3.30	3.40	
E2	1.60	1.7	1.80	
K	0.20			

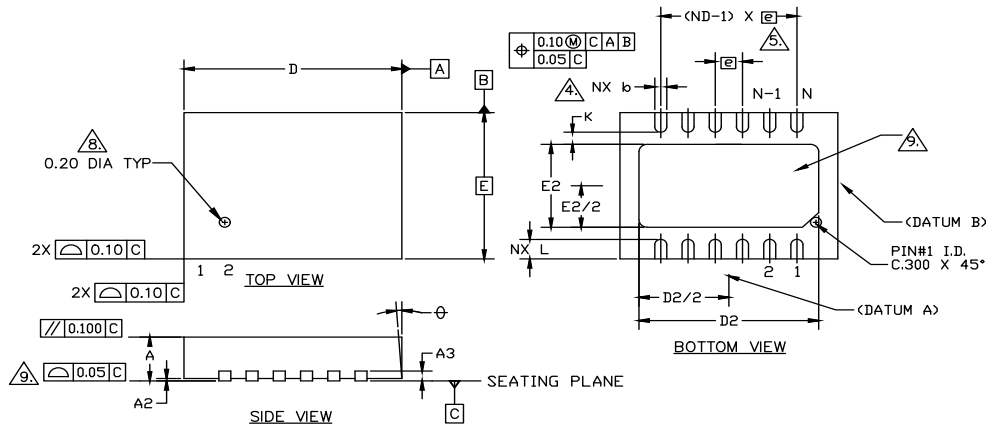

NOTES :

- DIMENSIONING AND TOLERANCING CONFORM TO ASME Y14.5M - 1994.
- ALL DIMENSIONS ARE IN MILLIMETERS, Ø IS IN DEGREES.
- N IS THE TOTAL NUMBER OF TERMINALS.
- ▲ DIMENSION b APPLIES TO METALLIZED TERMINAL AND IS MEASURED BETWEEN .15 AND .30mm FROM TERMINAL TIP.
- ▲ ND REFERS TO THE NUMBER OF TERMINALS ON D SIDE
- MAXIMUM PACKAGE WARPAGE IS .05 mm.
- MAXIMUM ALLOWABLE BURRS IS .076 mm IN ALL DIRECTIONS.
- PIN #1 ID ON TOP WILL BE LASER MARKED.
- ▲ UNILATERAL COPLANARITY ZONE APPLIES TO THE EXPOSED HEAT SINK SLUG AS WELL AS THE TERMINALS.
- THIS DRAWING CONFORMS TO JEDEC REGISTERED OUTLINE MO-229.
- ALL PLATED SURFACES TIN 0.010 mm +/- 0.005 mm

Pin	Input/Output
1	GND
2	NC
3	RF IN
4	RF IN
5	NC
6	GND
7	GND
8	NC
9	RF OUT
10	RF OUT
11	NC
12	GND

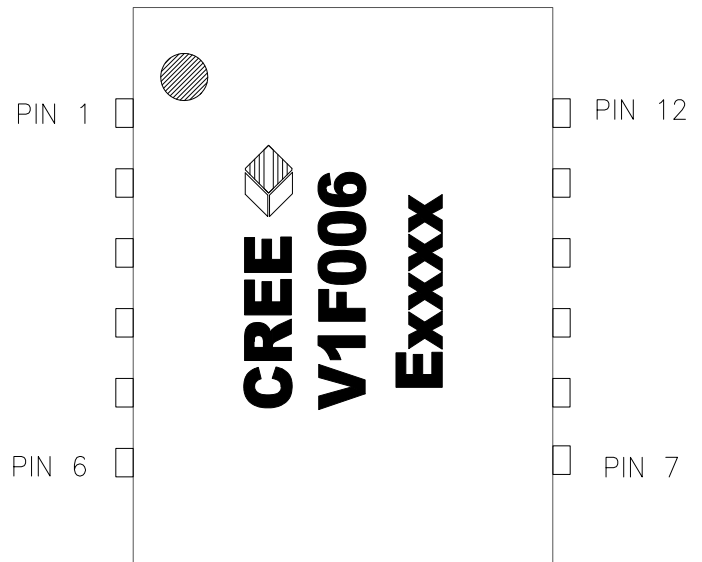

Note: Leadframe finish for 3x4 DFN package is Nickel/Palladium/Gold. Gold is the outer layer.

CGHV1F006S

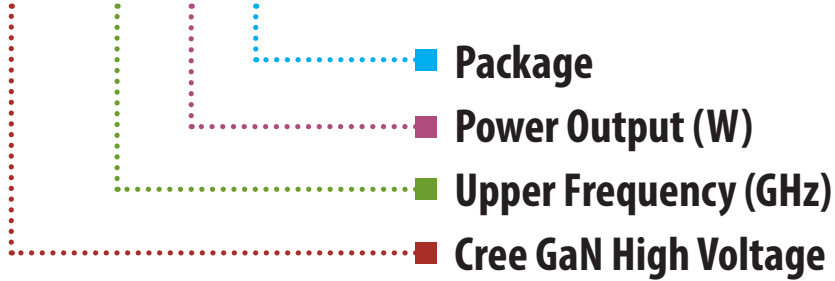

Parameter	Value	Units
Upper Frequency ¹	15.0	GHz
Power Output	6	W
Package	Surface Mount	-

Table 1.

Note¹: Alpha characters used in frequency code indicate a value greater than 9.9 GHz. See Table 2 for value.

Character Code	Code Value
A	0
B	1
C	2
D	3
E	4
F	5
G	6
H	7
J	8
K	9
Examples:	1A = 10.0 GHz 2H = 27.0 GHz

Table 2.

Product Ordering Information

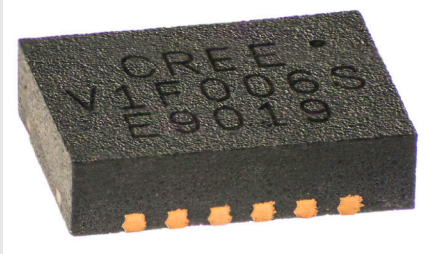
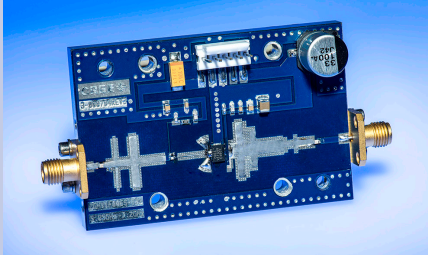
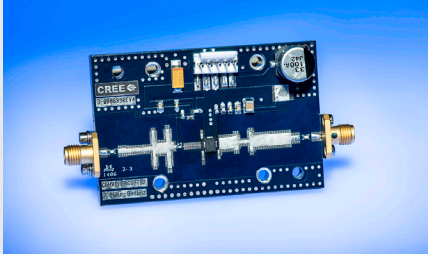
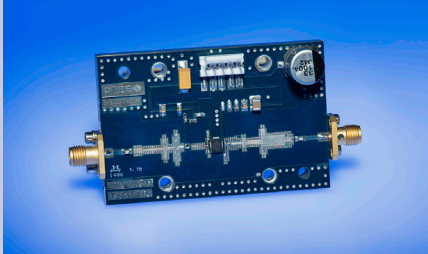
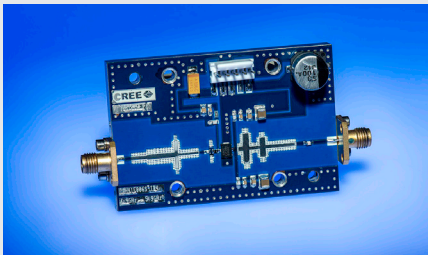
Order Number	Description	Unit of Measure	Image
CGHV1F006S	GaN HEMT	Each	
CGHV1F006S-AMP1	Test board with GaN HEMT installed, 5.85 - 7.2 GHz, 50 V C-Band under OQPSK	Each	
CGHV1F006S-AMP2	Test board with GaN HEMT installed, 7.9 - 8.4 GHz, 28 V X-Band SATCOM	Each	
CGHV1F006S-AMP3	Test board with GaN HEMT installed, 8.5 - 9.6 GHz, 28 V X-Band RADAR	Each	
CGHV1F006S-AMP4	Test board with GaN HEMT installed, 4.9 - 5.9 GHz, 50 V 802.11	Each	
CGHV1F006S-TR	Delivered in Tape and Reel	250 parts / reel	



Disclaimer

Specifications are subject to change without notice. Cree, Inc. believes the information contained within this data sheet to be accurate and reliable. However, no responsibility is assumed by Cree for any infringement of patents or other rights of third parties which may result from its use. No license is granted by implication or otherwise under any patent or patent rights of Cree. Cree makes no warranty, representation or guarantee regarding the suitability of its products for any particular purpose. "Typical" parameters are the average values expected by Cree in large quantities and are provided for information purposes only. These values can and do vary in different applications and actual performance can vary over time. All operating parameters should be validated by customer's technical experts for each application. Cree products are not designed, intended or authorized for use as components in applications intended for surgical implant into the body or to support or sustain life, in applications in which the failure of the Cree product could result in personal injury or death or in applications for planning, construction, maintenance or direct operation of a nuclear facility.

For more information, please contact:

Cree, Inc.
4600 Silicon Drive
Durham, North Carolina, USA 27703
rfsales@cree.com
www.cree.com/rf