

SpiceLED[™]

Like spice, its diminutive size is a stark contrast to its standout performance in terms of brightness, durability and reliability. Despite being the smallest in size yet the SpiceLED[™] packs a powerful performance and is a highly reliable design device. Its versatility enables its application in automotive appliances, key-pad illumination, hand-held devices such as PDAs, notebooks, compact back-lighting applications, consumer appliances, office equipment, audio and video equipment.

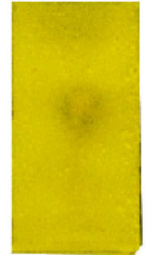

Features:

- > High brightness surface mount LED.
- > Super wide viewing angle of 160°.
- > Equivalent to 0603 package outline. Copper lead-frame construction.
- > Qualified according to JEDEC moisture sensitivity Level 2.
- > Compatible to IR reflow soldering.
- > Environmental friendly; RoHS compliance.
- > Compliance to automotive standard; AEC-Q101.
- > Superior Corrosion Resistant.



Applications:

- > Automotive: Interior applications, eg: switches, telematics, climate control system, dashboard, etc
- > Signage: full colour display video notice board, signage, special effect lighting.



Optical Characteristics at Tj=25°C

Part Ordering Number	Color	Viewing Angle°	Luminous Intensity @ IF = 20mA IV (mcd) <small>Appx. 1.1</small>		
			Min.	Typ.	Max.
SSW-LLG-T2U-1	White	160	355.00	500.00	715.00
SSW-LLG-T2U-JKPL	White	160	355.00	500.00	715.00
● SSW-LLG-U2V-1	White	160	560.00	850.00	1125.00

● Not for new design

Part Number	Vf @ If = 20mA <small>Appx. 3.1</small>			Vr @ Ir = 10uA
	Min. (V)	Typ. (V)	Max. (V)	Min. (V)
SSW-LLG	2.9	3.2	3.6	5

Absolute Maximum Ratings

	Maximum Value	Unit
DC forward current	30	mA
Peak pulse current; (tp ≤ 10μs, Duty cycle = 0.1)	100	mA
Reverse voltage; Ir _{max} = 10μA	5	V
ESD threshold (HBM)	2000	V
LED junction temperature	110	°C
Operating temperature	-40 ... +100	°C
Storage temperature	-40 ... +100	°C
Power dissipation (at room temperature)	80	mW
Thermal resistance		
- Junction / ambient, R _{th JA}	215	K/W
- Junction / solder point, R _{th JS}	125	K/W
(Mounted on FR4 PCB; pad size ≥16mm ² per pad)		

Wavelength Grouping *Appx. 2.1*

For this color bin selection, part number will be SSW-LLG-xxxx-1

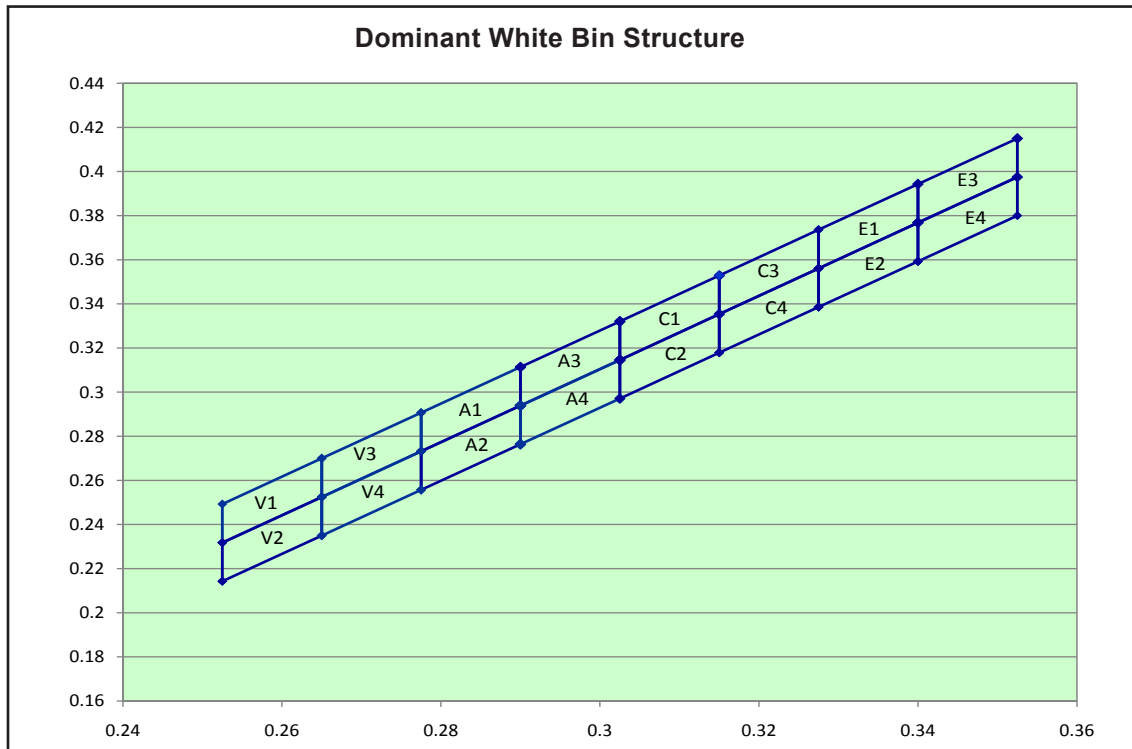

Bin		1	2	3	4
V1	Cx	0.2525	0.2650	0.2650	0.2525
	Cy	0.2318	0.2525	0.2700	0.2493
V2	Cx	0.2525	0.2650	0.2650	0.2525
	Cy	0.2143	0.2350	0.2525	0.2318
V3	Cx	0.2650	0.2775	0.2775	0.2650
	Cy	0.2525	0.2732	0.2907	0.2700
V4	Cx	0.2650	0.2775	0.2775	0.2650
	Cy	0.2350	0.2557	0.2732	0.2525
A1	Cx	0.2775	0.2900	0.2900	0.2775
	Cy	0.2732	0.2939	0.3114	0.2907
A2	Cx	0.2775	0.2900	0.2900	0.2775
	Cy	0.2557	0.2764	0.2939	0.2732
A3	Cx	0.2900	0.3025	0.3025	0.2900
	Cy	0.2939	0.3146	0.3321	0.3114
A4	Cx	0.2900	0.3025	0.3025	0.2900
	Cy	0.2764	0.2971	0.3146	0.2939
C1	Cx	0.3025	0.3150	0.3150	0.3025
	Cy	0.3146	0.3354	0.3529	0.3321
C2	Cx	0.3025	0.3150	0.3150	0.3025
	Cy	0.2971	0.3179	0.3354	0.3146
C3	Cx	0.3150	0.3275	0.3275	0.3150
	Cy	0.3354	0.3561	0.3736	0.3529
C4	Cx	0.3150	0.3275	0.3275	0.3150
	Cy	0.3179	0.3386	0.3561	0.3354

Bin		1	2	3	4
E1	Cx	0.3275	0.3400	0.3400	0.3275
	Cy	0.3561	0.3768	0.3943	0.3736
E2	Cx	0.3275	0.3400	0.3400	0.3275
	Cy	0.3386	0.3593	0.3768	0.3561
E3	Cx	0.3400	0.3525	0.3525	0.3400
	Cy	0.3768	0.3975	0.4150	0.3943
E4	Cx	0.3400	0.3525	0.3525	0.3400
	Cy	0.3593	0.3800	0.3975	0.3768

Wavelength Grouping *Appx. 2.1*

For this color bin selection, part number will be SSW-LLG-xxxx-JKPL

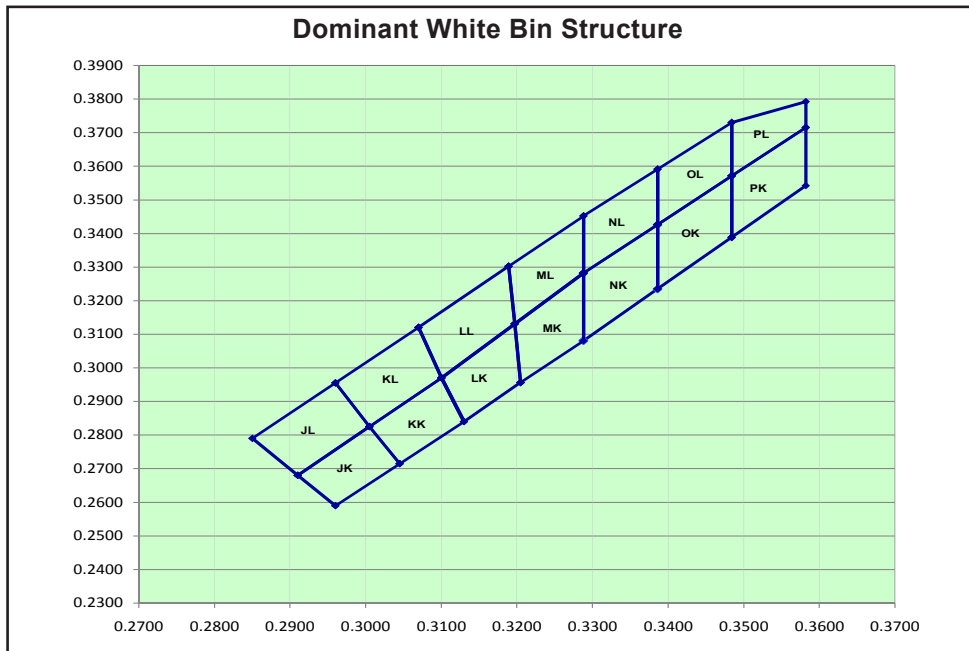

Bin		1	2	3	4
JK	Cx	0.2960	0.2910	0.3005	0.3045
	Cy	0.2590	0.2680	0.2825	0.2715
JL	Cx	0.291	0.2850	0.2960	0.3005
	Cy	0.2680	0.2790	0.2955	0.2825
KK	Cx	0.3045	0.3005	0.3100	0.3130
	Cy	0.2715	0.2825	0.2970	0.2840
KL	Cx	0.3005	0.2960	0.3070	0.3100
	Cy	0.2825	0.2955	0.3120	0.2970
NK	Cx	0.3288	0.3288	0.3386	0.3386
	Cy	0.3081	0.3282	0.3426	0.3235
NL	Cx	0.3288	0.3288	0.3386	0.3386
	Cy	0.3282	0.3453	0.3591	0.3426
OK	Cx	0.3386	0.3386	0.3484	0.3484
	Cy	0.3235	0.3426	0.3571	0.3388
OL	Cx	0.3386	0.3386	0.3484	0.3484
	Cy	0.3426	0.3591	0.3730	0.3571
LK	Cx	0.3100	0.3197	0.3205	0.3130
	Cy	0.2970	0.3131	0.2956	0.2840
LL	Cx	0.3070	0.3189	0.3197	0.3100
	Cy	0.3120	0.3302	0.3131	0.2970
MK	Cx	0.3197	0.3288	0.3288	0.3205
	Cy	0.3131	0.3282	0.3081	0.2956
ML	Cx	0.3189	0.3288	0.3288	0.3197
	Cy	0.3302	0.3452	0.3282	0.3131
PK	Cx	0.3484	0.3484	0.3582	0.3582
	Cy	0.3388	0.3571	0.3715	0.3542
PL	Cx	0.3484	0.3484	0.3582	0.3582
	Cy	0.3571	0.3730	0.3792	0.3715

Luminous Intensity Group at Tj=25°C

Brightness Group	Luminous Intensity ^{Appx. 1.1} IV (mcd)
T2	355.0 ... 450.0
U1	450.0 ... 560.0
U2	560.0 ... 715.0
V1	715.0 ... 900.0
V2	900.0 ... 1125.0

Vf Binning (Optional)

Vf Bin @ 20mA	Forward Voltage (V) ^{Appx. 3.1}
01	2.90 ... 3.00
02	3.00 ... 3.10
03	3.10 ... 3.20
04	3.20 ... 3.30
05	3.30 ... 3.40
06	3.40 ... 3.50
07	3.50 ... 3.60

Please consult sales and marketing for special part number to incorporate Vf binning.

Relative Luminous Intensity Vs Forward Current

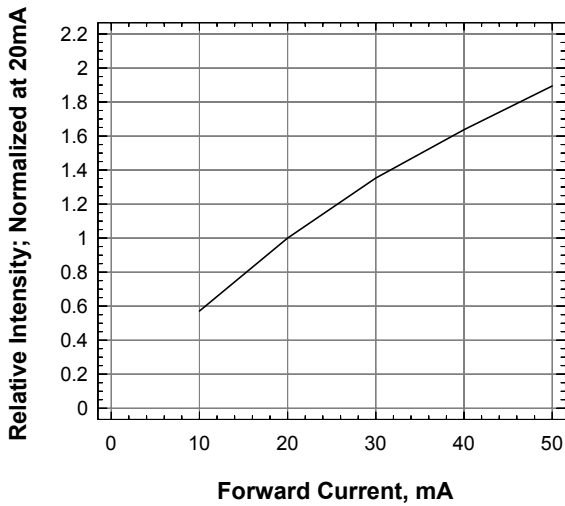

Forward Current Vs Forward Voltage

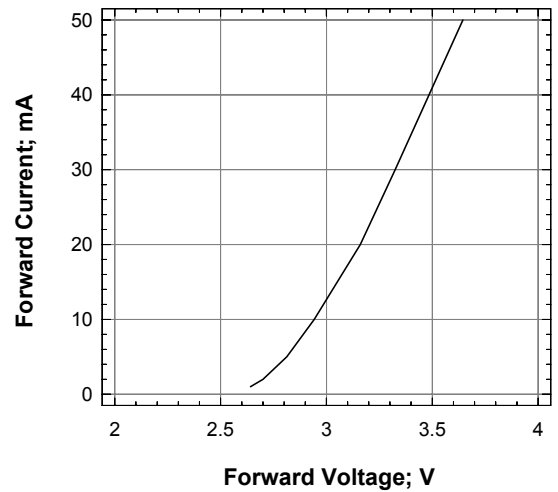

Forward Current Vs Ambient Temperature

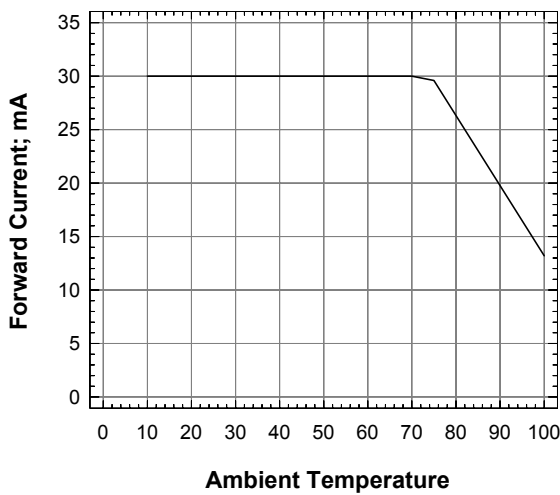

Relative Intensity Vs Wavelength

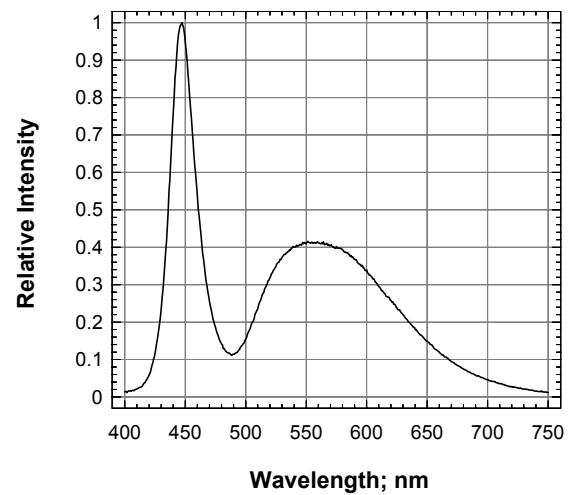

Chromaticity Coordinate Shift

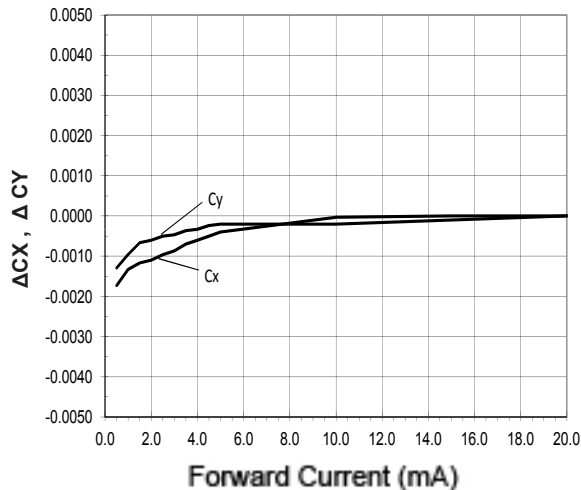

Radiation Pattern

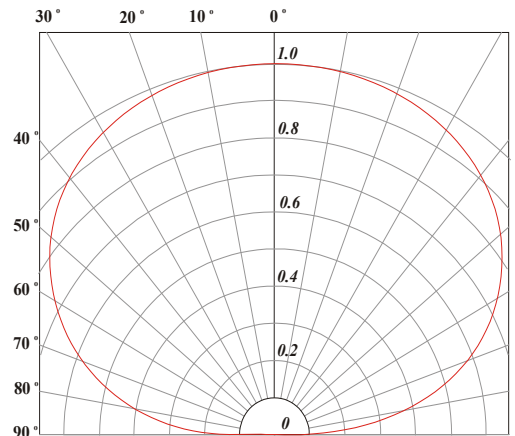

SpiceLED™ • InGaN White S-Spice : SSW-LLG Package Outlines

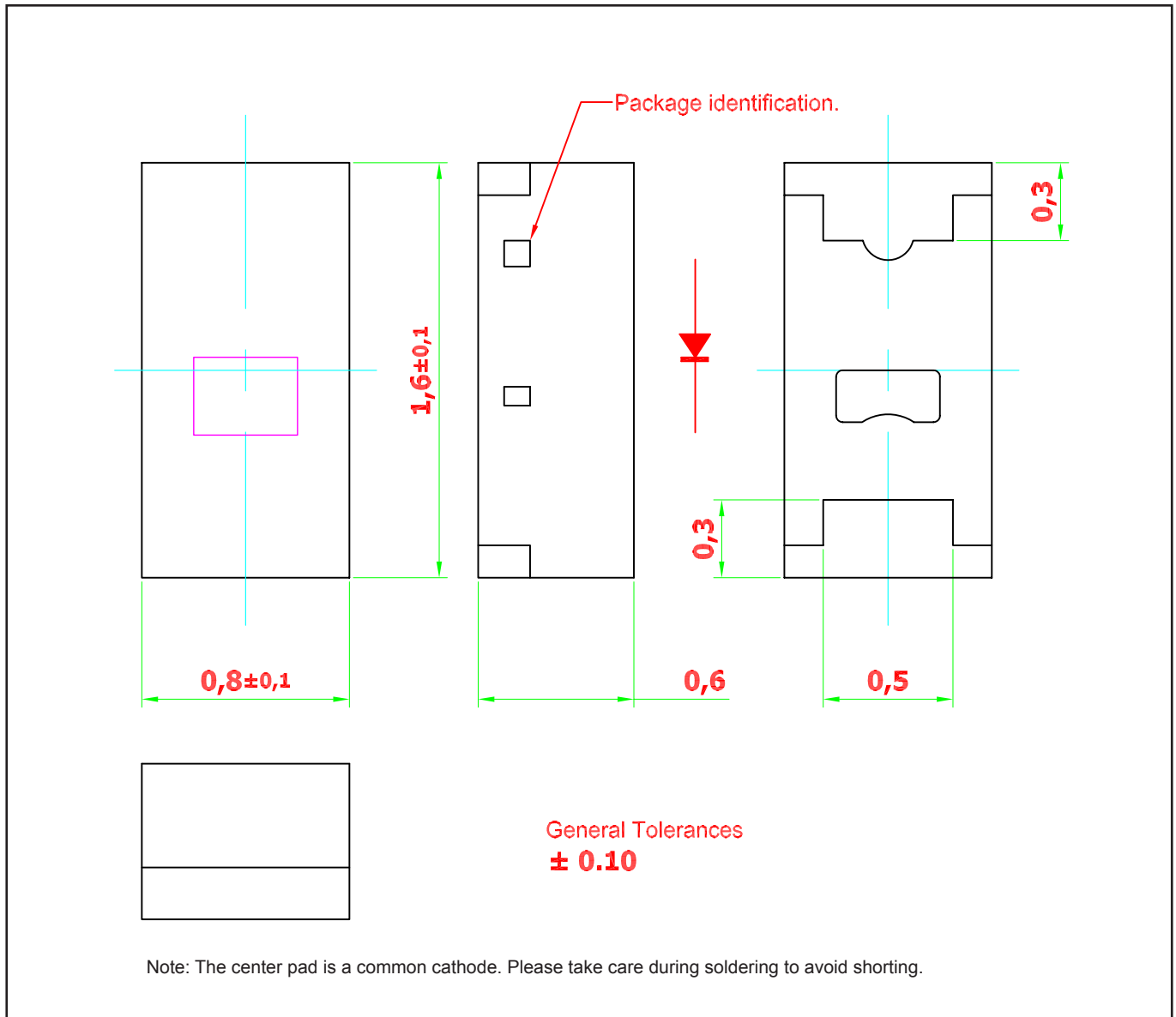

Material

Material	
Lead-frame	Cu Alloy With NiPdAu Plating
Package	High Temperature Resistant Epoxy Resin

Note: product is Pb free

Recommended Solder Pad

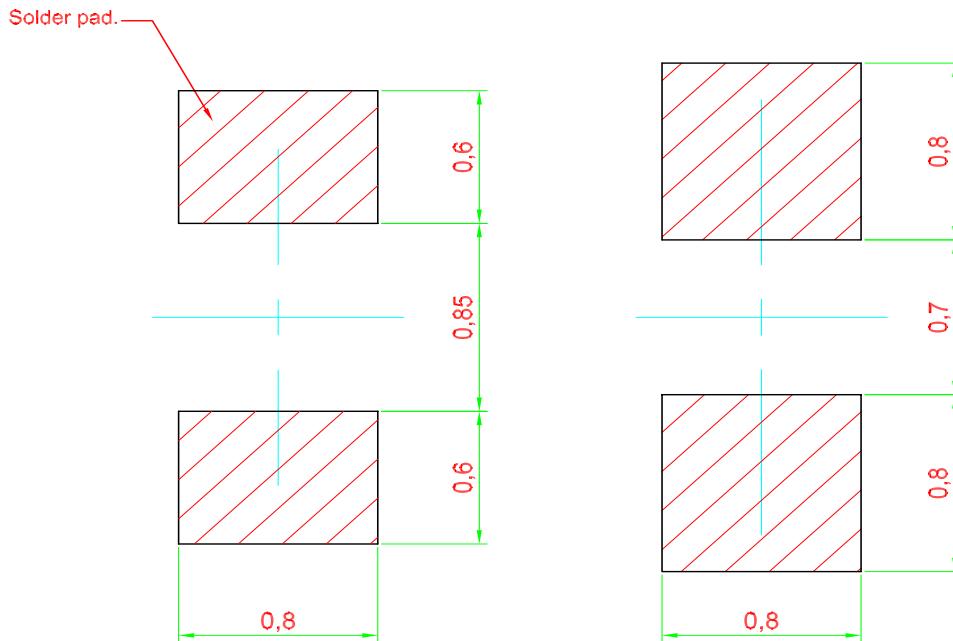

Recommended Solder-pad

Alternative Solder-pad
 Compatible to ChipLED 0603

Note: Component is based on a new package platform, which features “Bottom Only Terminations”. Solder joints are only formed at the bottom of the component and solder fillet will not be observable as the sides of the component.

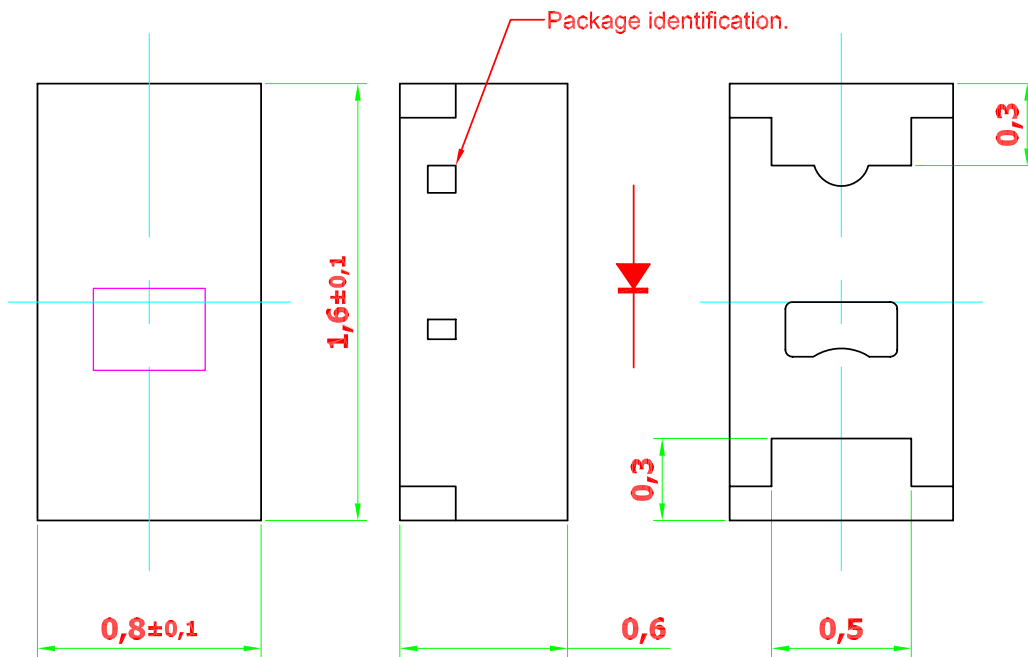

Surface are not intended for soldering

General Tolerances
± 0.10

Packaging Specification

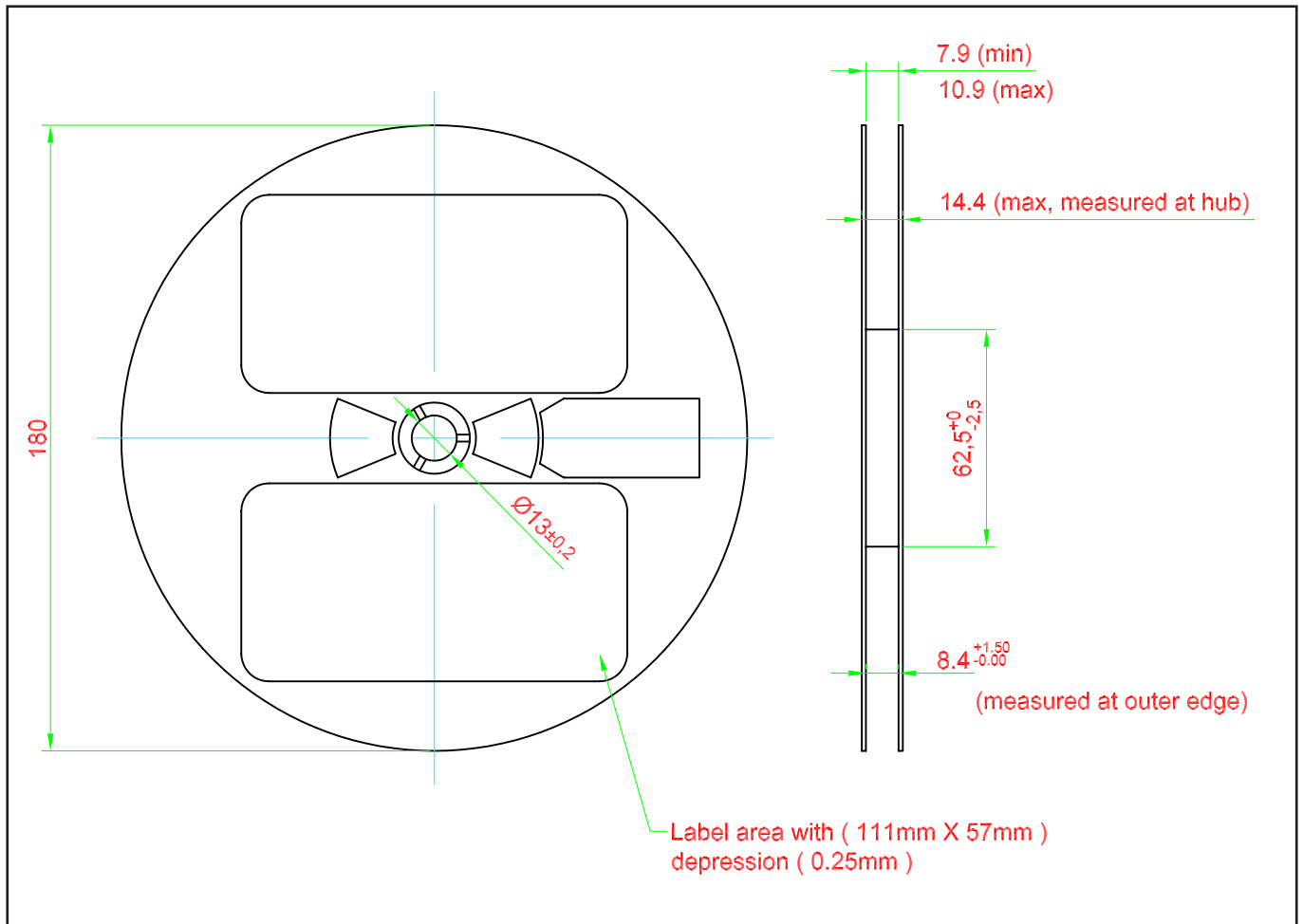

Packaging Specification

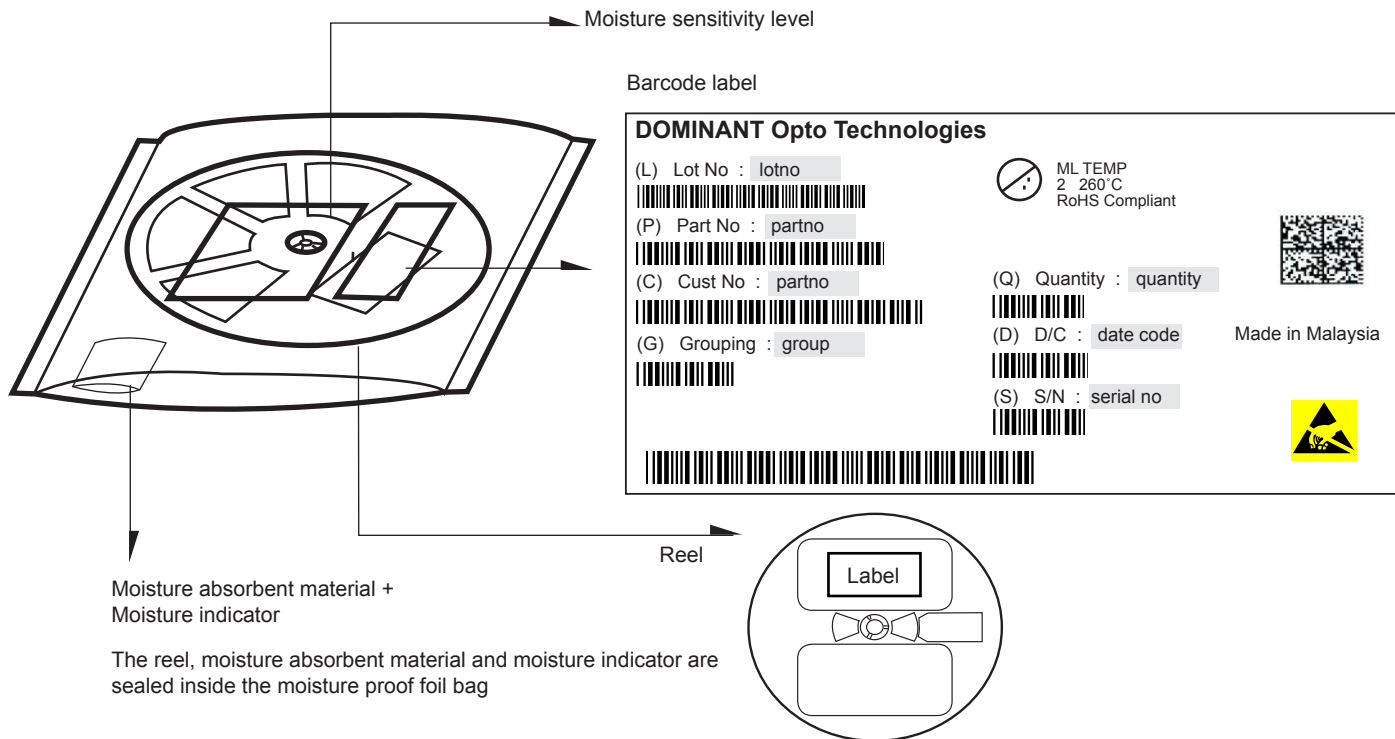

	Average 1pc SpiceLED	1 completed bag (3000pcs)
Weight (gram)	0.002	140 ± 10

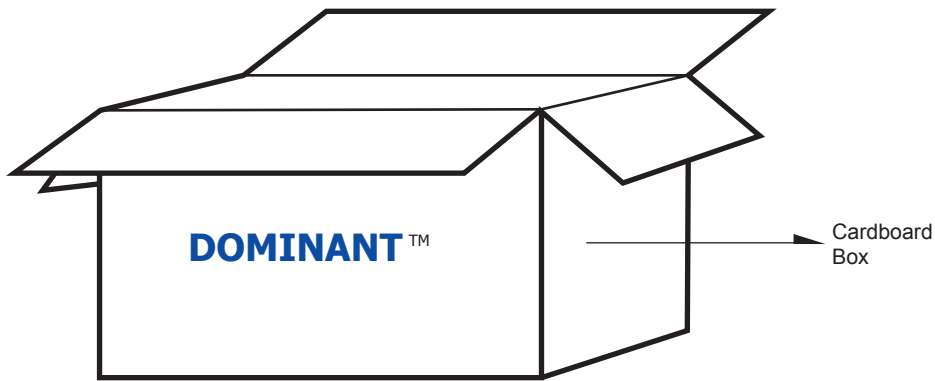

For SpiceLED

Cardboard Box Size	Dimensions (mm)	Empty Box Weight (kg)	Reel / Box
Super Small	325 x 225 x 190	0.38	9 reels MAX
Small	325 x 225 x 280	0.54	15 reels MAX
Medium	570 x 440 x 230	1.46	60 reels MAX
Large	570 x 440 x 460	1.92	120 reels MAX

Recommended Pb-free Soldering Profile

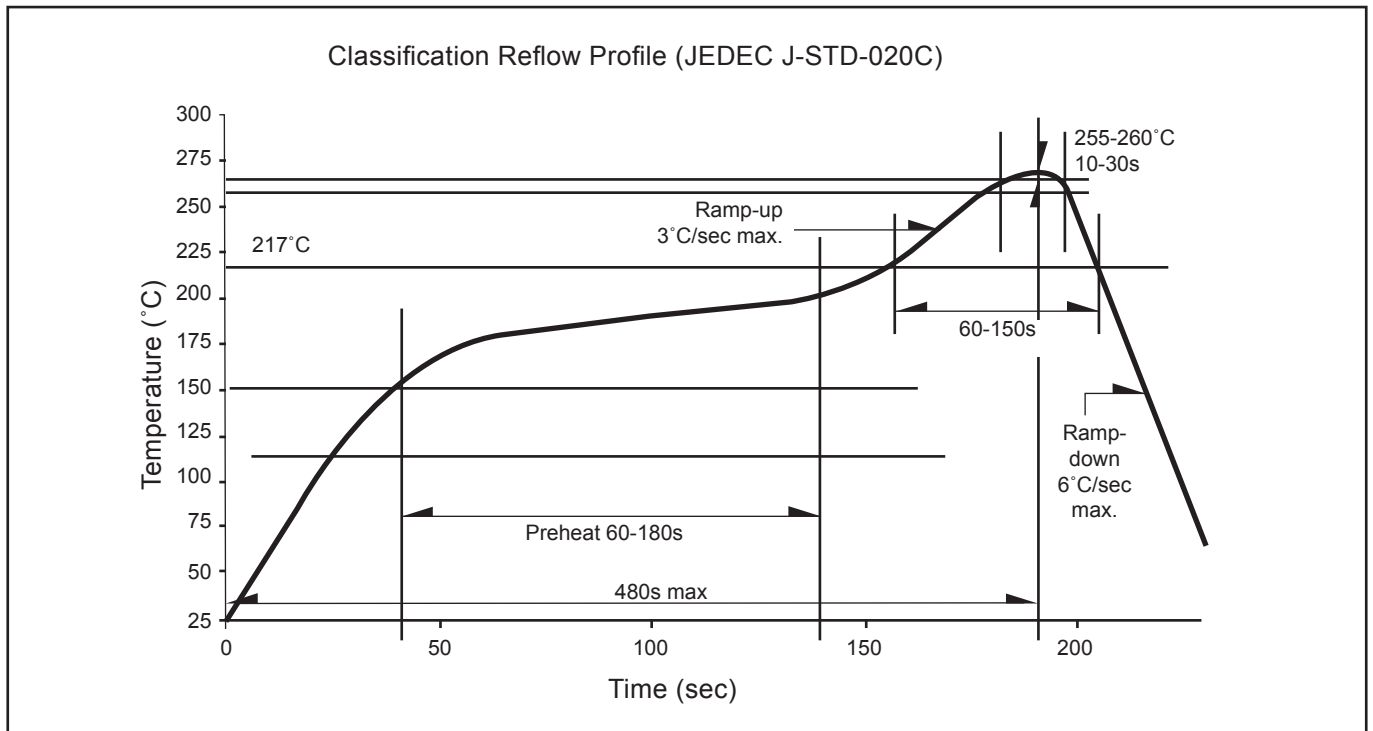

Appendix

1) **Brightness:**

- 1.1 Luminous intensity is measured with an internal reproducibility of $\pm 8 \%$ and an expanded uncertainty of $\pm 11 \%$ (according to GUM with a coverage factor of $k=3$).
- 1.2 Luminous flux is measured with an internal reproducibility of $\pm 8 \%$ and an expanded uncertainty of $\pm 11 \%$ (according to GUM with a coverage factor of $k=3$).

2) **Color:**

- 2.1 Chromaticity coordinate groups are measured with an internal reproducibility of ± 0.005 and an expanded uncertainty of ± 0.01 (accordingly to GUM with a coverage factor of $k=3$).
- 2.2 DOMINANT wavelength is measured with an internal reproducibility of $\pm 0.5\text{nm}$ and an expanded uncertainty of $\pm 1\text{nm}$ (accordingly to GUM with a coverage factor of $k=3$).

3) **Voltage:**

- 3.1 Forward Voltage, V_f is measured with an internal reproducibility of $\pm 0.05\text{V}$ and an expanded uncertainty of $\pm 0.1\text{V}$ (accordingly to GUM with a coverage factor of $k=3$).

Revision History

Page	Subjects	Date of Modification
-	Initial release	16 May 2012
2	Add new partno: SSW-LLG-U2V-1	04 Oct 2012
2	Not for new design: SSW-LLG-U2V-1	06 Sep 2013
10	Update Carrier Tape	13 Feb 2014
2, 5	Add new partno: SSW-LLG-T2U-JKPL Add new color bin structure	09 Jan 2015
1, 7	Update Features Add Graph: Chromaticity Coordinate Shift	22 May 2015
1, 10, 12, 14	Add Features Error on Taiping and Orientation Update Packaging Specification Add Appendix	26 Oct 2016

NOTE

All the information contained in this document is considered to be reliable at the time of publishing. However, DOMINANT Opto Technologies does not assume any liability arising out of the application or use of any product described herein.

DOMINANT Opto Technologies reserves the right to make changes to any products in order to improve reliability, function or design.

DOMINANT Opto Technologies products are not authorized for use as critical components in life support devices or systems without the express written approval from the Managing Director of DOMINANT Opto Technologies.

About Us

DOMINANT Opto Technologies is a dynamic company that is amongst the world's leading automotive LED manufacturers. With an extensive industry experience and relentless pursuit of innovation, DOMINANT's state-of-art manufacturing and development capabilities have become a trusted and reliable brand across the globe. More information about DOMINANT Opto Technologies, a ISO/TS 16949 and ISO 14001 certified company, can be found under <http://www.dominant-semi.com>.

Please contact us for more information:

DOMINANT Opto Technologies Sdn. Bhd.
Lot 6, Batu Berendam, FTZ Phase III, 75350 Melaka, Malaysia
Tel: (606) 283 3566 Fax: (606) 283 0566
E-mail: sales@dominant-semi.com
