

Phase Control SCR 1600 Amperes Average 2400 Volts

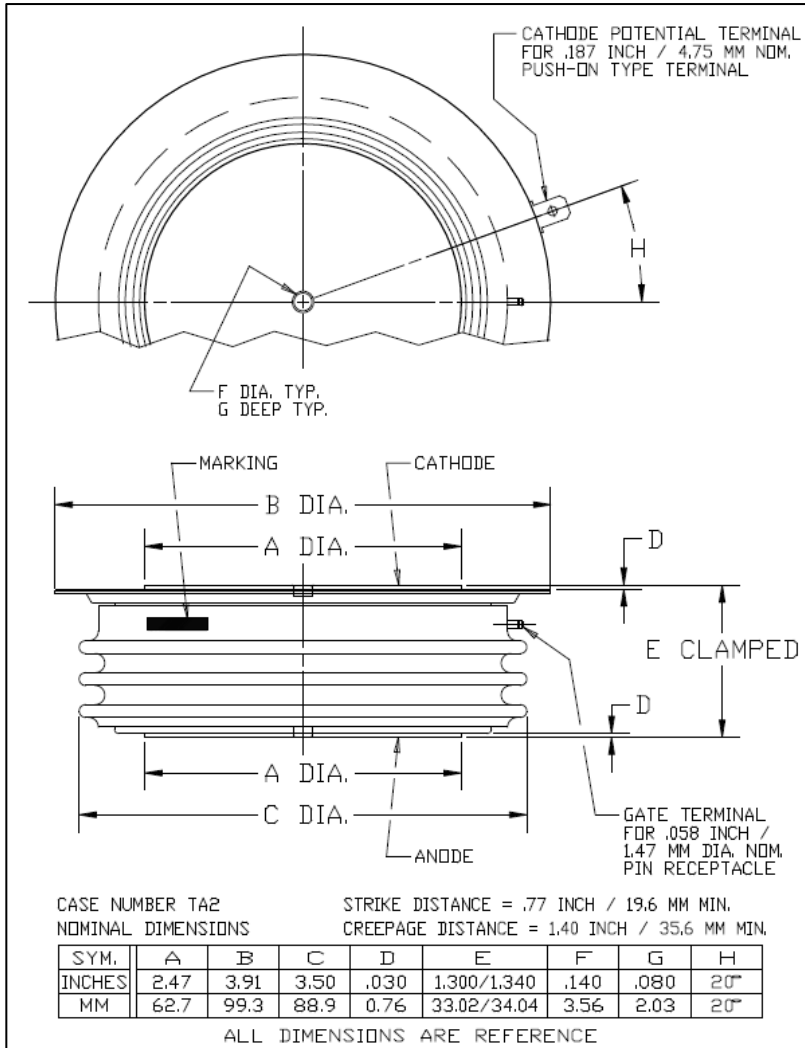

TA20 1600A (Outline Drawing)

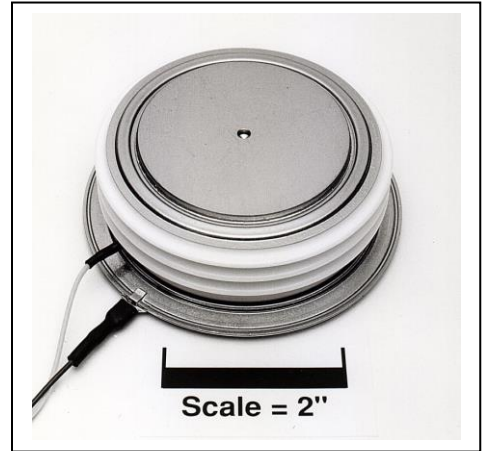

TA20 1600A Phase Control SCR
1600 Amperes Average, 2400 Volts

Description:

Powerex Silicon Controlled Rectifiers (SCR) are designed for phase control applications. These are all-diffused, Press-Pak, hermetic Pow-R-Disc devices employing the field proven amplifying gate.

Features:

- Low On-State Voltage
- High di/dt Capability
- High dv/dt Capability
- Hermetic Packaging
- Excellent Surge and I^2t Ratings

Applications:

- Power Supplies
- Motor Control

Ordering Information:

Select the complete 12 digit module part number from the table below.
Example: TA20121603DH is a 1200V 1600A Phase Control SCR.

Type	Voltage V_{RRM} (Volts)	Current $I_{T(av)}$ (A)	Turn-off Time t_q (μ sec)	Gate Current I_{GT} (mA)	Lead Code
TA20	02 through 24	16	0	3	DH
	200V through 2400V	1600A	250 μ sec (Typical)	200 mA	12"



**TA20
1600A**

POWEREX, Inc. 173 Pavilion Ln Youngwood, PA USA 724-925-7272 www.pwrx.com

**ntrol SCR
Amperes Average
Volts**

Absolute Maximum Ratings

Characteristics	Symbol	Units
Non-Repetitive Transient Peak Reverse Blocking Voltage	V_{RSM} $V_{RRM} + 100V$	Volts
RMS On-State Current, $T_C = 80^\circ C$	$I_{T(RMS)}$ 2500	Amperes
Average Current 180° Sine Wave, $T_C = 80^\circ C$	$I_{T(AV)}$ 1600	Amperes
RMS On-State Current, $T_C = 55^\circ C$	$I_{T(RMS)}$ 3390	Amperes
Average Current 180° Sine Wave, $T_C = 55^\circ C$	$I_{T(AV)}$ 2160	Amperes
Peak One Cycle Surge On-State Current (Non-Repetitive) 60 Hz	I_{TSM} 29,500	Amperes
Peak One Cycle Surge On-State Current (Non-Repetitive) 50 Hz	I_{TSM} 26,900	Amperes
Critical Rate-of-rise of On-State Current (Non-Repetitive)	di/dt 400	A/ μ sec
Critical Rate-of-rise of On-State Current (Repetitive)	di/dt 150	A/ μ sec
I^2t (for Fusing) for One Cycle, 60 Hz	I^2t 3.63×10^6	A ² sec
Peak Gate Power Dissipation	P_{GM} 16	Watts
Average Gate Power Dissipation	$P_{G(av)}$ 3	Watts
Operating Temperature	T_J -40 to +125	°C
Storage Temperature	T_{stg} -40 to +150	°C
Approximate Weight	2.1	lb.
	950	g
Mounting Force	9000 to 11000	lb.
	4100 to 5000	kg.

Information presented is based upon manufacturers testing and projected capabilities.
This information is subject to change without notice.
The manufacturer makes no claim as to the suitability of use, reliability, capability,
or future availability of this product.

Electrical Characteristics, $T_J=25^\circ\text{C}$ unless otherwise specified

Characteristics	Symbol	Test Conditions	Min.	Typ.	Max.	Units
Repetitive Peak Reverse Leakage Current	I_{RRM}	$T_J=125^\circ\text{C}, V_R = V_{RRM}$			100	mA
Repetitive Peak Forward Leakage Current	I_{DRM}	$T_J=125^\circ\text{C}, V_D = V_{DRM}$			100	mA
Peak On-State Voltage	V_{TM}	$I_{FM}=3000\text{A peak},$ Duty Cycle < 0.1 %			1.75	V
Threshold Voltage, Low-level	$V_{(TO)1}$	$T_J = 125^\circ\text{C}, I = 15\%I_{T(AV)} \text{ to } \pi I_{T(AV)}$			0.89109	V
Slope Resistance, Low-level	r_{T1}				0.2148	m Ω
Threshold Voltage, High-level	$V_{(TO)2}$	$T_J = 125^\circ\text{C}, I = \pi I_{T(AV)} \text{ to } I_{TSM}$			1.7405	V
Slope Resistance, High-level	r_{T2}				0.1024	m Ω
V_{TM} Coefficients, Low-level		$T_J = 125^\circ\text{C}, I = 15\%I_{T(AV)} \text{ to } \pi I_{T(AV)}$ $V_{TM} = A + B \ln(I) + C(I) + D \text{ Sqrt}(I)$	A =	1.1219		
			B =	-0.10195		
			C =	4.764E-05		
			D =	0.02077		
V_{TM} Coefficients, High-level		$T_J = 125^\circ\text{C}, I = \pi I_{T(AV)} \text{ to } I_{TSM}$ $V_{TM} = A + B \ln(I) + C(I) + D \text{ Sqrt}(I)$	A =	-3.7832		
			B =	0.56271		
			C =	3.607E-05		
			D =	0.010389		
Typical Turn-On Time	t_{on}	$I_T = 1000\text{A}, V_D = 1500 \text{ V}$		4		μs
Typical Turn-Off Time	t_q	$T_J = 125^\circ\text{C}, I_T = 250\text{A},$ $di_R/dt = 50\text{A}/\mu\text{s}$ Reapplied $dv/dt = 20 \text{ V}/\mu\text{s}$ Linear to 80% V_{DRM}		250		μs
Minimum Critical dv/dt – Exponential to V_{DRM}	dv/dt	$T_J = 125^\circ\text{C}$	300			V/ μs
Gate Trigger Current	I_{GT}	$T_J = 25^\circ\text{C}, V_D = 12 \text{ V}$			200	mA
Gate Trigger Voltage	V_{GT}	$T_J = 25^\circ\text{C}, V_D = 12 \text{ V}$			4.5	V
Non-Triggering Gate Voltage	V_{GDM}	$T_J = 125^\circ\text{C}, V_D = V_{DRM}$			0.15	V
Peak Forward Gate Current	I_{GTM}				4	A
Peak Reverse Gate Voltage	V_{GRM}				5	V

4.5
Thermal Characteristics

Maximum Thermal Resistance, Double Sided Cooling		Max.	Units
Junction-to-Case	$R_{\Theta(J-C)}$	0.015	$^\circ\text{C}/\text{W}$
Case-to-Sink	$R_{\Theta(C-S)}$	0.007	$^\circ\text{C}/\text{W}$

Maximum On-State Forward Voltage Drop
($T_j = 125^\circ\text{C}$)

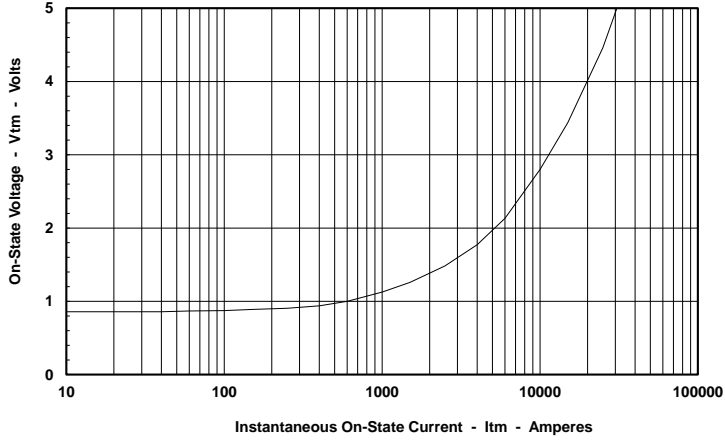

Maximum Transient Thermal Impedance
(Junction to Case)

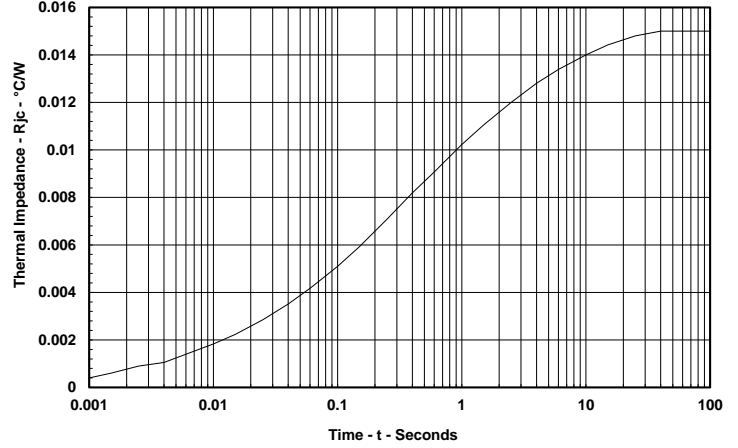

Maximum On-State Power Dissipation
(Sinusoidal Waveform)

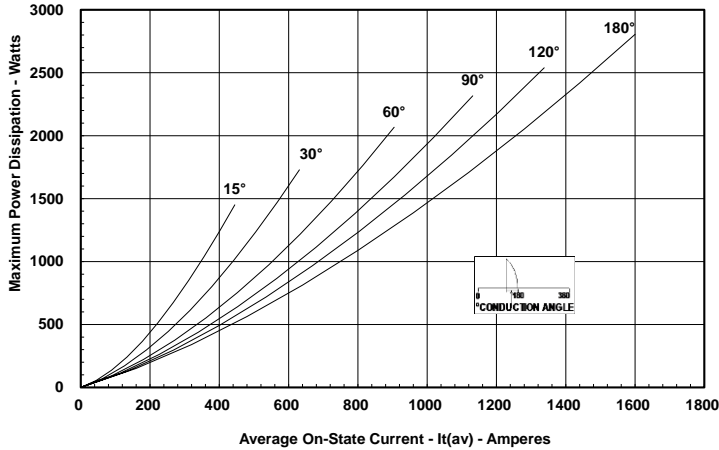

Maximum Allowable Case Temperature
(Sinusoidal Waveform)

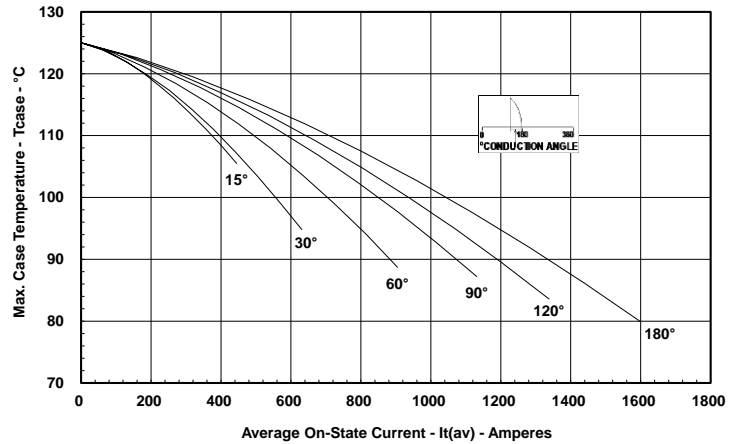

Maximum On-State Power Dissipation
(Rectangular Waveform)

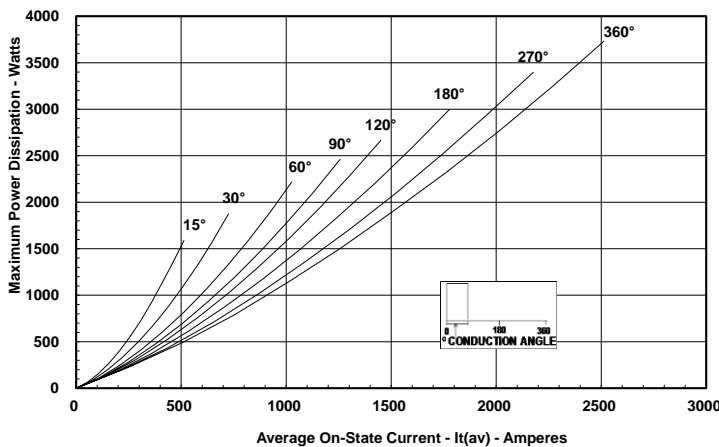

Maximum Allowable Case Temperature
(Rectangular Waveform)

